

JRC TECHNICAL REPORTS

Design Guidelines for Wall Panel Connections

Antonella Colombo, Marco Lamperti,
Paolo Negro, Giandomenico Toniolo
Editors

2016

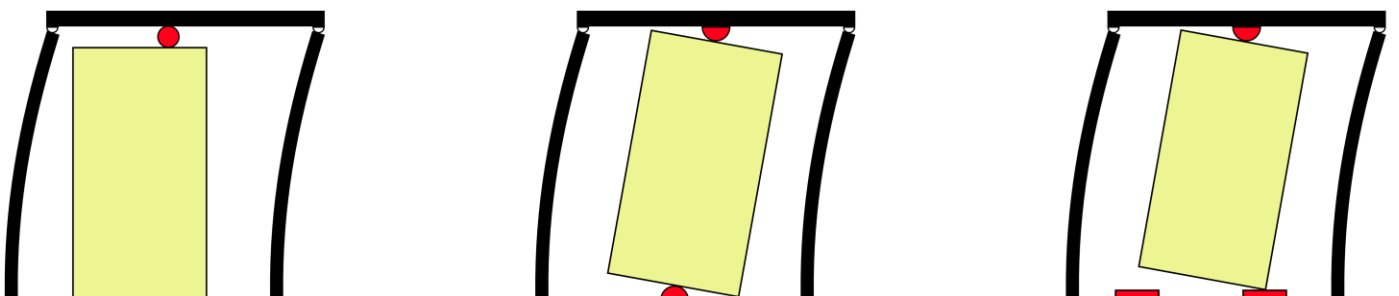

This publication is a Technical report by the Joint Research Centre, the European Commission's in-house science service. It aims to provide evidence-based scientific support to the European policy-making process. The scientific output expressed does not imply a policy position of the European Commission. Neither the European Commission nor any person acting on behalf of the Commission is responsible for the use which might be made of this publication.

Contact information

Name: Paolo Negro

Address: Joint Research Centre, via Enrico Fermi 2749, TP 480, 21027 Ispra (VA), Italy

E-mail: paolo.negro@jrc.ec.europa.eu

Tel.: +39 0332 78 5452

JRC Science Hub

<https://ec.europa.eu/jrc>

JRC 101780

EUR 27934 EN

ISBN 978-92-79-58533-3

ISSN 1831-9424

doi:10.2788/546845

© European Union, 2016

Reproduction is authorised provided the source is acknowledged.

All images © European Union 2016

How to cite: Antonella Colombo, Paolo Negro, Giandomenico Toniolo, Marco Lamperti (Editors); Design Guidelines for Wall Panel Connections; EUR 27934 EN; doi:10.2788/956845

Table of contents

Foreword	5
Acknowledgements	5
Abstract	6
Scope	7
Terms and symbols	7
Properties	9
Classification	9
Bibliography	9
1. Existing buildings	10
1.1 Structural arrangements	10
1.2 Second line back up devices	11
1.3 Strengthening folded steel plates	13
1.4 Strengthening with steel cushions	14
2. Current fastening systems	15
2.1 Structural arrangements	15
2.2 Hammer-head strap connection	16
2.2.1 General description	16
2.2.2 <i>Design - general</i>	17
2.2.3 <i>Design based on the simplified model, neglecting panel-to-structure interaction</i>	17
2.2.3.1 Deformation capacity control	17
2.2.3.2 Gap closure control	18
2.2.4 <i>Design based on the refined model considering panel-to-structure interaction</i>	19
2.2.4.1. Hysteretic response envelope	19
2.2.4.2. Hysteretic behaviour model	21
2.2.5 <i>Other aspects</i>	21
2.3 Cantilever box connection	22
2.3.1 <i>General description</i>	22
2.3.2 <i>Design - general</i>	22
2.3.3 <i>Design based on the simplified model, neglecting panel-to-structure interaction</i>	23
2.3.4 <i>Design based on the refined model considering panel-to-structure interaction</i>	23
2.3.4.1. Hysteretic response envelope	23
2.3.4.2. Hysteretic behaviour model	24
2.4 Steel angle connections	25
2.4.1 <i>General description</i>	25
2.4.2 <i>Design - general</i>	26
2.4.3 <i>Design based on the refined model considering panel-to-structure interaction</i>	26

2.4.3.1 Hysteretic response envelope	26
2.4.3.2. Hysteretic behaviour model	27
3. ISOSTATIC SYSTEMS	28
3.1 Structural arrangements	28
3.2 Sliding devices.....	31
3.2.1 <i>General</i>	31
3.2.2 <i>Dimensioning</i>	32
3.3 Vertical supports.....	32
3.3.1 <i>Rotating devices</i>	32
3.3.2 <i>Supports with steel brackets</i>	33
3.4 Effects of silicone sealing	34
4. INTEGRATED SYSTEMS	36
4.1 Structural arrangements	36
4.2 Base supports	37
4.2.1 <i>Connections with protruding bars</i>	38
4.2.1.1 General	38
4.2.1.2 Strength	39
4.2.1.3 Verifications	40
4.2.1.4 Any other data	41
4.2.2 <i>Connections with wall shoes</i>	42
4.2.2.1 General	42
4.2.2.2 Strength	43
4.2.2.3 Verifications	44
4.2.2.4 Any other data	45
4.2.3 <i>Connections with bolted plates</i>	46
4.2.3.1 General	46
4.2.3.2 Strength	47
4.2.3.3 Verifications	48
4.2.3.4 Any other data	50
4.3.2 <i>Shear keys</i>	51
5. DISSIPATIVE SYSTEMS.....	53
5.1 Structural arrangements	53
5.2 Friction devices.....	54
5.2.1 <i>Properties</i>	55
5.2.2 <i>Design</i>	56
5.2.3 <i>Behaviour model</i>	57
5.3 Multi-slit devices	58
5.3.1 <i>Properties</i>	58

5.3.2 <i>Design</i>	59
5.3.3 <i>Behaviour model</i>	59
5.4 Steel cushions.....	60
5.4.1 <i>Properties</i>	60
5.4.2 <i>Design</i>	61
5.4.3 <i>Behaviour model</i>	61
5.4.4 <i>Other aspects</i>	64
5.5 Folded steel plates	67
ANNEX A: Capacity and stiffness of a typical restraining device	70

Foreword

This document has been drafted within Work-Package WP6, "Derivation of design guidelines" of the SAFECLADDING Project (FP7-SME-2012-2 Programme, Research for SME associations - Grant agreement n. 314122).

The SAFECLADDING project (Improved Fastening Systems of Cladding Wall Panels of Precast Buildings in Seismic Zones) is a comprehensive research and development action performed by a group of European associations of precast element producers and industrial partners with the assistance of a group of RTD providers.

The partners were: BIBM, European Federation for the Precast Concrete industry, represented by Dr. Alessio Rimoldi; ASSOBETON, National Italian Association of Precast Concrete Producers, represented by Dr. Antonella Colombo; TPCA, Turkish Precast Concrete Association, represented by Dr. Bulent Tokman; ECS, European Engineered Construction System Association, represented by Dr. Thomas Sippel; POLIMI, Politecnico di Milano, represented by Prof. Fabio Biondini; UL, University of Ljubljana, represented by Prof. Matej Fischinger; NTUA, National Technical University of Athens, represented by Prof. Ioannis Psycharis; ITU, Istanbul Technical University, represented by Prof. Faruk Karadogan; JRC, Joint Research Centre - Elsa Laboratory, represented by Dr. Paolo Negro; B.S. Italia, represented by Mr. Sergio Zambelli; YAPI, Yapi Merkezi Construction and Industry Inc, represented by Mr. Orhan Manzac; ANDECE, Asociación Nacional de la Industria del Prefabricado de Hormigón, represented by Mr. Alejandro Lopez Vidal.

Dr. Alessio Rimoldi served as the coordinator of the SAFECLADDING project. And Prof. Giandomenico Toniolo was charged with the technical management of the SAFECLADDING project and was the Work-Package leader for the Work-Package WP6 "Derivation of design guidelines", of which this document represents the final outcome.

Acknowledgements

Dr. Alessio Rimoldi served as the coordinator of the SAFECLADDING project.

Prof. Giandomenico Toniolo were charged with the technical management of the SAFECLADDING project and was the Work-Package leader for the Work-Package WP6 "Derivation of design guidelines", of which this document represents the final outcome.

The following institutions and individuals contributed to the obtainment of the scientific basis and to the drafting of the guidelines:

BIBM – A. Rimoldi

ASSOBETON – A. Colombo

TPCA – B. Tokman

ECS – T. Sippel

POLIMI – F. Biondini, B. Dal Lago, G. Toniolo, A. Titi

UL – M. Fischinger, T. Isakovic, B. Zoubek, J. Lopatič, M. Urbas

NTUA – I. Psycharis, I. Kalyviotis, E. Pavlopoulou, H. Mouzakis, L. Karapitta, E. Avgenakis

ITU – F. Karadogan, E. Yüksel, I. E. Bal, H. Ozkaynak, E. Symru, A. Gullu, T. Gökçe, A. Khajehdehi, M. Mandavi, F. Azizisales

JRC – P. Negro, M. Lamperti, P. Pegon, F. J. Molina, P. Caperan, B. Viaccoz, M. Peroni, P. Petit

B.S. Italia – S. Zimbelli, C. Pagani, A. Gasperi

YAPI – O. Manzac, Y. Karakus

ANDECE – A. Lopez Vidal, S. Fernandez Ayala

Abstract

The current design practice of precast buildings is based on a frame mode, where the peripheral cladding panels enter only as masses without any stiffness. The panels are then connected to the structure with fastenings dimensioned with a local calculation on the basis of their mass for anchorage forces orthogonal to the plane of the panels.

This design approach does not work, as it was recently dramatically shown by several recent violent shakes, like L'Aquila (Italy) in 2009, Grenada (Spain) in 2010, and Emilia (Italy) in 2012. The panels, fixed in this way to the structure, come to be an integral part of the resisting system, conditioning its seismic response. The high stiffness of this resisting system leads to forces much higher than those calculated from the frame model. These forces are related to the global mass of the floors and are primarily directed in the plane of the walls.

Furthermore, the seismic force reduction in the type of precast structures of concern relies on energy dissipation in plastic hinges formed in the columns. Very large drifts of the columns are needed to activate this energy dissipation foreseen in design. However, typically, the capacity of the connections between cladding and structure is exhausted well before such large drifts can develop. Therefore, the design of these connections cannot rely on the seismic reduction factor used for design of the bare structure.

New technological solutions for connectors with proper design approaches were urgently required. The research project SAFELCLADDING was thus aimed at investigating, by means of a balanced combination of experimental and analytical activity, the seismic behaviour of precast structures with cladding wall panels and at developing innovative connection devices and novel design approaches for a correct conception and dimensioning of the fastening system to guarantee good seismic performance of the structure throughout its service life.

The final outcome of the SAFELCLADDING project is represented by a set of documents providing the design guidelines produced by the consortium. The guidelines have a theoretical derivation supported by the experimental results of the testing campaigns and numerical simulations performed within the project. General know-how on production practice and international literature on the subject have been also considered.

The present document provides the design guidelines for the wall panel connections. A companion document provides the design guidelines for precast structures with cladding panels.

Introduction

The fall of cladding wall panels under earthquake action shall be prevented following the same requirement of no collapse stated for the main structure by *EC8*.

To this end the fastening devices and the whole connections of wall panels shall be verified for the effects of the seismic action in terms of forces and/or displacements as calculated through the proper analysis of the structural assembly. The model used in this analysis shall fulfil the principles stated in *DGB*.

Scope

The present document refers to the panel-to-structure and panel-to panel connections used for the cladding systems of precast frame structures of single-storey buildings. They can be used also for multi-storey buildings with proper modifications.

With respect to the overall arrangement of connections and to the relative degree of interaction between cladding panels and the main structure, four solutions are specifically treated in the following chapters.

The first is a solution with the connections currently used in design practice (Chapters 1 and 2). In Chapter 1 it is considered that these connections in the existing buildings are frequently under proportioned. In such a case the structure can be provided with a second line of back-up devices against the fall of panels in case of connection failure (Section 1.2). This solution can be used for a quick upgrading of existing buildings in order to ensure their operativeness for a transitory period. An alternative solution for the upgrading of existing buildings can be obtained with additional ductile fastening devices (See Sections 1.3 and 1.4). In Chapter 2 it is considered that in some cases (see *DGB*) the current connections in existing and new buildings can provide adequate seismic behaviour. The data and the design guidelines which are needed to analyze buildings using the current fastening systems are provided in Sections 2.2-2.4.

The second is an isostatic arrangement of panel connections able to allow without reactions the large displacements expected for the frame structure under earthquake conditions (Chapter 3). Very large displacement capacities are required for connectors with this choice.

The third is a hyperstatic arrangement of fixed connections that integrates the panels in the resistant structural assembly with a dual wall-frame system behaviour (Chapter 4). Very high forces may arise in the connections with this choice.

The fourth is an arrangement of dissipative connections between the panels added to an isostatic system of fastenings to the structure, able to keep displacements and forces within lower predetermined limits (Chapter 5).

The fastening devices considered in the present document consist mainly of steel fixed or sliding connectors. Dissipative devices with friction or plastic behaviour are also considered. Other types of common supports and bond connections are treated where needed.

Terms and symbols

Figure 0.1 represents a vertical panel referred to a system of orthogonal axis, where x is oriented horizontally in the panel plane, y is oriented orthogonally to that plane and z is oriented vertically parallel to the gravity loads. The origin is placed in a corner at the base side of the panel.

Four connections are foreseen at the corners of the panel, indicated respectively by A , B , C and D . Any one of these connections is intended to give only translational restraints without any rotational restraint. With E and F are indicated the possible joint connections

with the adjacent panels. Usually the connections *A* and *B* are attached to the foundation beam, the connections *C* and *D* are attached to the top beam.

The couple of bottom and top connections may be replaced by single connections placed in the middle of the bottom and top sides for a pendulum arrangement of the panel. In this case the connections are respectively named *A* and *C* and the symbols *B* and *D* are omitted.

The same reference system is associated in Figure 0.2 to a horizontal panel, for which usually the connections *A*, *B*, *C* and *D* are attached to the columns and *E* and *F* refer to the possible joint connections with the adjacent panels, where the uncertain friction effect due to the superimposed panels may act.

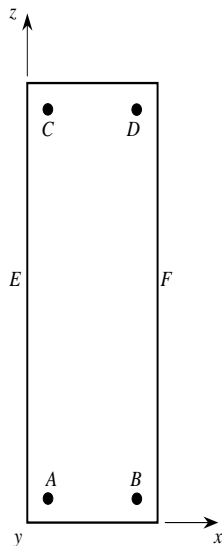

Figure 0.1

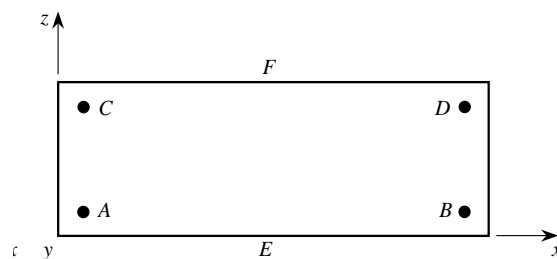

Figure 0.2

As an example, Table 0.1 gives the "arrangement matrix" indicating, for a vertical panel, the effect of the supports along the three directions *x*, *y* and *z*, where the symbols are:

- f = fixed (bilateral)
- f+ = fixed (unilateral in + direction)
- f- = fixed (unilateral in - direction)
- s = sliding (bilateral)
- i = indifferent
- d = dissipative
- 0 = absent
- / = omitted

The term "fixed" is used with reference to the restrained linear displacement while the rotational restraints are never provided.

	A	B	C	D	E	F
x	f	/	S	/	f	f
y	f	/	F	/	0	0

z	f	/	i	/	d	d
---	---	---	---	---	---	---

Table 0.1

The effect of the connections in the plane of the panel can be also represented in the graphic scheme of the panel by the symbols \leftrightarrow \updownarrow \blacktriangledown \blacktriangle \blacktriangleleft \blacktriangleright that represent respectively the slide freedoms in the directions x and z and the unilateral supports along z and along x.

Properties

General reference is made to Clause 03 of DG0. In addition to what given in that clause, the following specifications are listed.

Among the main parameters that characterize the seismic behaviour of the connection, the following one is added: slide: free linear relative displacement capacity with null or negligible reaction.

The main behaviour parameters are provided for each x, y, z direction defined in Clause 02 specifying possible interaction effects.

In general, when using connection devices coming from the current industrial production, reference shall be done to the technical sheet of the product given by the producer where the required parameters are reported together with the related tolerances acceptable for the good functioning of the product.

Classification

General reference is made to Clause 04 of DG0. In addition to what given in that clause, the following specifications are listed.

For the connections present in existing buildings, where sufficient information about their strength and/or ductility are not available, the classification of unknown can be stated. The classification of brittle connection can be given to existing types which behaviour in recent earthquake has been demonstrated as such. The classification of insufficient can be given to existing connections when a specific calculation under the expected seismic action shows their inadequate strength.

Bibliography

Some references are here listed together with the corresponding abbreviated symbol used in the text.

DG0 Design guidelines for connections of precast structures under seismic action (SAFECAS^T Project), 2012 JRC Scientific and policy reports

DGB Design guidelines for precast structures with cladding panels (SAFECLADDING Project), 2016 JRC Technical Reports

EC2 EN 1992-1-1 Eurocode 2: Design of concrete structures – Part 1-1: General rules and rules for Buildings, 2004 CEN

PT4 EN 1992-1-4 Eurocode 2: Design of concrete structures – Part 1-4: Design of fastenings for use in concrete, 2014 CEN

EC3 EN 1993-1-1 Eurocode 3: Design of steel structures – Part 1-1 General rules and rules for Buildings, 2005 CEN

PT8 EN 1993-1-8 Eurocode 3: Design of steel structures – Part 1-8 Design of joints, 2005 CEN

EC8 EN 1998-1 Design of structures for earthquake resistance – Part 1: General rules, seismic action and rules for buildings, 2004 CEN

ETS European Technical Specification of the concerned product

1. Existing buildings

For the seismic analysis the old design practice of the precast structures of concern is often based on a bare frame model where the peripheral cladding panels enter only as masses without any stiffness. The panels are then connected to the structure with fixed (pinned) fastenings dimensioned with a local calculation on the base of their single mass for anchorage forces orthogonal to the plane of the panels.

This approach frequently didn't work: the recent earthquakes have demonstrated it. The panels, fixed in this way to the structure, depending on the actual degree of stiffness of the connectors, may come to be integral part of the resisting system, conditioning its seismic response as of a dual wall-frame system of lower energy dissipation capacity. The high stiffness of this resisting system leads to much higher forces than those calculated from the frame model. These forces are related to the global mass of the floors and are primarily directed in the plane of the walls. The unforeseen intensity and direction of the forces drove many fastenings to failure, leaving the frame of columns and beams practically undamaged.

The failure of their fastenings implies the fall of panels that can have up to 10 tons of weight. The mortal danger of these collapses requires a different approach. For the many existing buildings designed following this old practice proper upgrading or retrofitting interventions shall be made. These interventions are needed also for the many existing buildings originally designed not for seismic action and placed in areas that now, following the updated knowledge, are classified as seismic zones.

1.1 Structural arrangements

Table 1.1 gives the arrangement matrix of a very common connection system used during many years for vertical panels: the unit is simply supported on the foundation beam without mechanical connectors; it is connected to the top beam through vertical channel bars and headed fasteners giving a bilateral out-of-plane y restraint and an unintended "weak" bilateral restraint with limited movement allowance in the horizontal x direction. Figure 1.1 shows the graphic scheme of the arrangement.

	A	B	C	D	E	F
x	f*	f*	f	f	0	0
y	f	f	f	f	0	0
z	f	f	s	s	0	0

f* restrain due to friction

Table 1.1

Table 1.2 gives the arrangement matrix of one of the connection systems used during many years for horizontal panels: the unit is connected to the two lateral columns; the two lower connections consist of steel corbels protruding from the columns proportioned to give the vertical -z support to the panel; the two upper connections consist of shear dowels that ensure the bilateral horizontal x restraint; all the four connections provide the bilateral horizontal y restraint. Figure 1.2 shows the graphic scheme of the arrangement.

	A	B	C	D	E	F
x	f*	f*	f	f	0	0
y	f	f	f	f	0	0
z	f	f	s	s	0	0

f* weak unintended restraint

Table 1.2

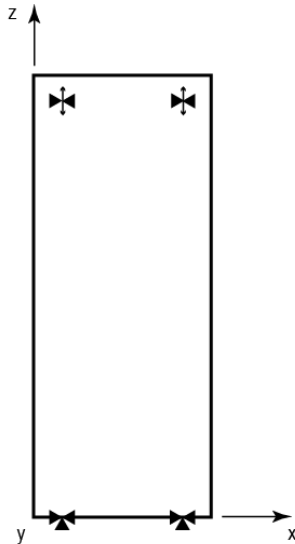

Figure 1.1

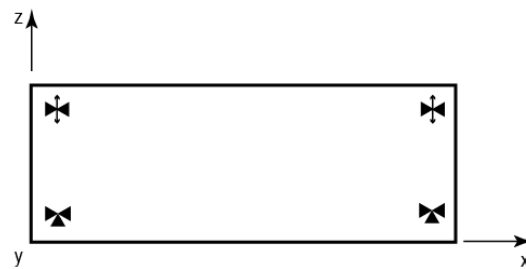

Figure 1.2

Both these connection systems failed in large number during recent earthquakes. Due to an inadequate resistance with respect to the longitudinal x force received and to the lack of ductility capacity they failed with a brittle rupture.

1.2 Second line back up devices

A little invasive technique of intervention on existing buildings to prevent the fall of wall panels under earthquake conditions consists of short slack cables connecting the panel to the main structural element as shown for vertical panels in Figure 1.3. This solution can be used only for a quick upgrading of existing buildings in order to ensure their operativeness for a (short) transitory period.

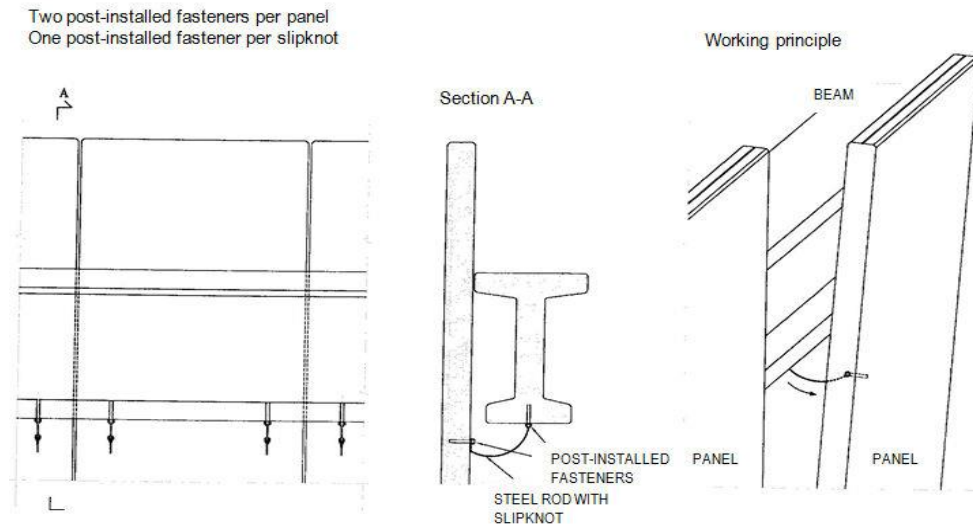

Figure 1.3

After the failure of the original fastenings, the motion of the panels is complex and the force demand on the restrainers at the time of the shock is difficult to evaluate. Nevertheless, the following expressions provide a reasonable estimate. The seismic force demand in short restrainers can be estimated as the larger of the forces listed below:

$$f = \sqrt{\left(k \frac{v_0}{\omega}\right)^2 + (2mS_a)^2}$$

$$f = \sqrt{2}k \frac{v_0}{\omega}$$

where

- ω frequency of the restrainer
- k stiffness of the restrainer
- m tributary mass of the panel, supported by the restrainer
- S_a maximum acceleration of the bare frame structure
- v_0 maximum velocity of the bare-frame structure
- ($v_0 = S_a / \Omega$, where Ω is the frequency of bare-frame structure)

The above formulae can be used for panel supported at their base, only if second order P- Δ effects are negligible. The ratio s/H , where s is the length of the restrainer and H is the distance between the bottom of the panel and the restrainer, should be less than 0,1. For panels that can fall from higher positions, again for short restrainers the conventional force should be referred to the double of their total weight.

For the proportioning of the end fastenings of the cable, a capacity design criterion should be applied, assuming a force equal to $\gamma_R A_s f_{ym}$, where A_s is the sectional area of the cable and $f_{ym} = 1,08 f_{yk}$ is its mean yield strength. This force should be not greater than the pull-out resistance of the panel fastener at one end, and not greater than the shear resistance of the beam fastener at the other end. The values $\gamma_R = 1,2$ for DCM and $\gamma_R = 1,35$ for DCH can be used as recommended by EC8.

The resistance verification of the entire restraining device (cable plus end fastenings) can be performed also by testing on a set up reproducing the local arrangement of the connection.

A possible alternative solution is illustrated in Figure 1.4: The system consists of wire or synthetic fibre rope and steel anchoring elements. It can be constructed with a wire or synthetic fibre rope terminated with a steel socket and anchoring elements. In the case of the failure of the existing panel-to-structure connections, the panel falls in the direction perpendicular to its plane, the rope is activated and the tension force is transmitted through the sockets into the steel anchoring elements and then into panel and beam.

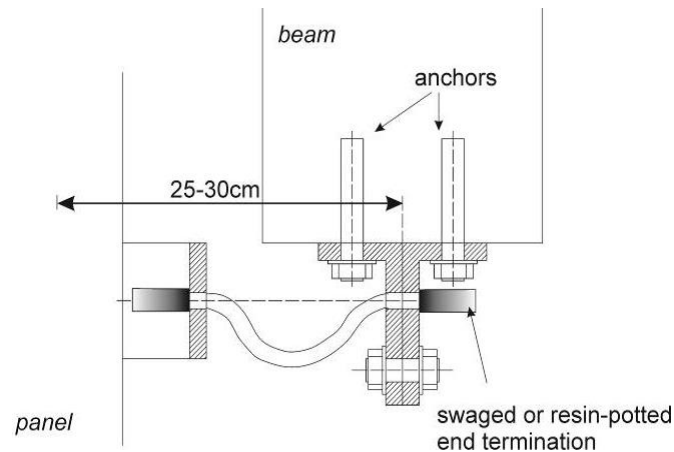

Figure 1.4

The stiffness, strength and deformation capacity of this restraining system should be determined experimentally. Information can be found in Annex A.

1.3 Strengthening folded steel plates

After the recent earthquakes that caused the fall of many wall panels, steel angles have been used in place or in addition to the original connectors in order to strengthen the connections of horizontal panels to the supporting columns (Figure 1.5). With reference to the longitudinal $-x$ direction this provision can strongly improve the resistance but without any ductile capacity, and can be justified only when the brittle failure is prevented by a proportioning of the connection verified with respect to the forces determined from the structural analysis of the dual wall-frame assembly.

Folded steel plates can be used, instead of steel angles, in existing buildings to retrofit or upgrade the connections of horizontal panels to the structure ensuring a good dissipative capacity through plastic cyclic deformations (Figure 1.6). As for the common steel angles, the installation of the steel folded plates doesn't require any special care for tolerances since they can be shaped in site on the existing situation and attached to column and panel with post-installed drilled fasteners.

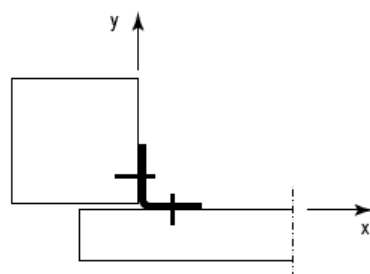

Figure 1.5

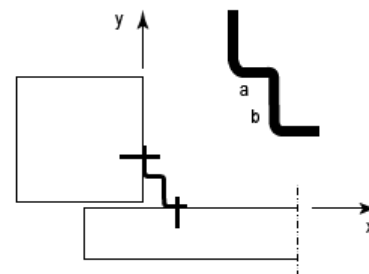

Figure 1.6

Folded steel plates can be effectively used also in new constructions. For their design see Clause 5.5.

1.4 Strengthening with steel cushions

Steel cushions can be used in existing buildings to retrofit or upgrade the connections of vertical panels to the structure ensuring a good dissipative capacity through plastic cyclic deformations (Figure 1.7). The installation of the steel cushions doesn't require any special care for tolerances since they can be shaped in site on the existing situation and attached to beam and panel with post-installed drilled fasteners.

Steel cushions should be proportioned to keep an elastic behaviour up to the serviceability limit state (with small deformations) and to display plastic deformations beyond this limit, with residual deformations after the earthquake and need of their replacement and adjustment of the panel arrangement.

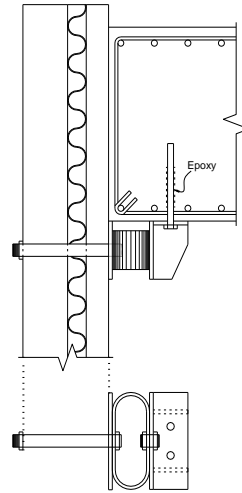

Figure 1.7

For the behaviour properties of steel cushions and the calculation models see Clause 5.4.

2. Current fastening systems

If the buildings using current fastening systems are analyzed, the deformation capacity of the system and the interaction of all components in the structure shall be in general carefully verified. Suitable design methodology is proposed in DGB. The data needed for this analysis (in particular, stiffness, deformation and strength capacity as well as hysteretic behaviour) are given in this chapter for the most common fastening types that are used today (Hammer-head strap connection – Section 2.2; Cantilever connections – Section 2.3 and Steel angle connections – Section 2.4). The use of any other existing fastening types or the above connections with different characteristics than those described in the following sections is not allowed unless comparable experimental and analytical studies do provide these data and verify the design methodology for the particular type.

The data in Sections 2.2 – 2.4 are provided for the two levels of analyses foreseen in DGB. For the simplified check of elastic displacements (Step 1 and 2 in the procedure outlined in DGB), only deformation capacity of the connection, based mainly on the geometric characteristics, is needed.

For the more refined analysis (Step 4 in the procedure outlined in DGB) a set of data is provided based on the experimental results; it includes strength and deformation capacity based on the cyclic envelope as well as hysteretic rules for inelastic response analysis.

2.1 Structural arrangements

The structural arrangements of vertical and horizontal panels, which are considered in the following sections, are presented in Figure 2.1 and 2.2. The arrangements are more or less similar to the arrangements presented in Figure 1.1 and 1.2 with some specific modifications, which are based on the analytically and experimentally observed response of the types of the connections presented in Sections 2.2 - 2.4.

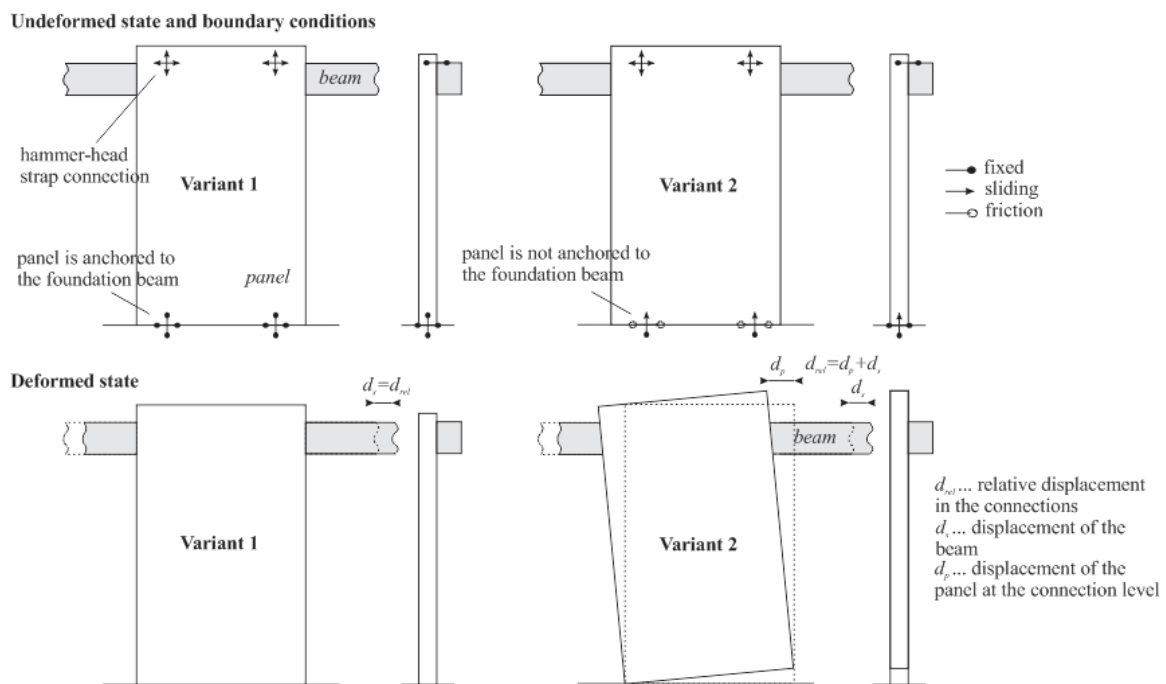

Figure 2.1: Structural arrangements of vertical panels considered in this section

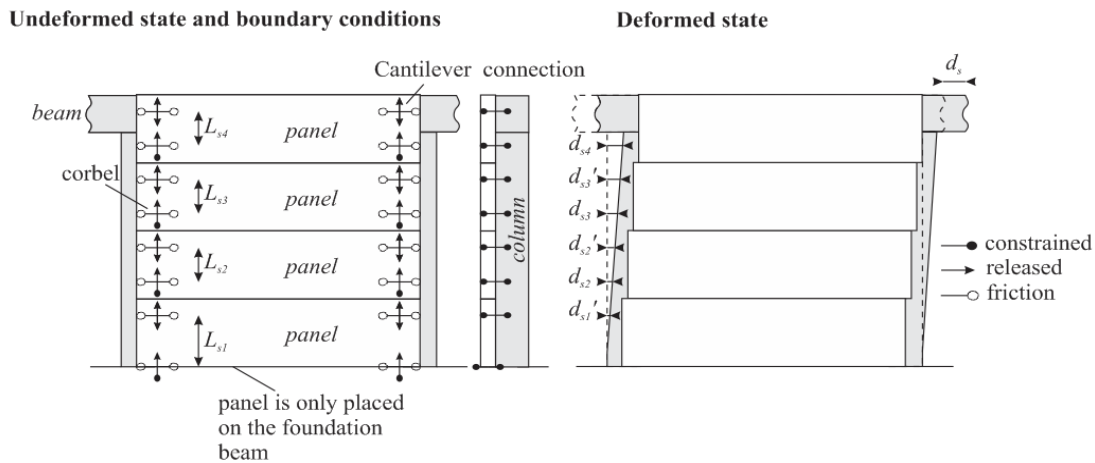

Figure 2.2: Structural arrangements of horizontal panels considered in this section

2.2 Hammer-head strap connection

2.2.1 General description

Hammer-head strap connection consists of two steel channels which are mounted in a beam (or column) and a panel and a hammer head strap which is fastened to the channel mounted in the beam (or column) by means of a single bolt (Figure 2.3). Hammer-head strap connections are most often used for fastening of vertical panels to the beams.

Hammer head strap connections could be provided with channels of different strength. Principally, two different types of channels should be recognized:

- *strong channel* – when loaded in shear, the connection fails due to the failure of the strap (Figure 2.4);
- *weak channel* – when loaded in shear, the connection fails due to the failure of the channel (Figure 2.5).

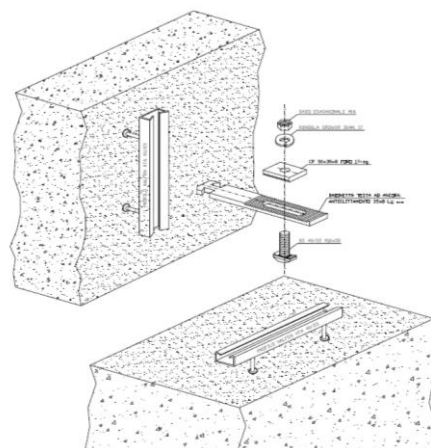

Figure 2.3: Schematic presentation of the hammer-head strap connection assembly

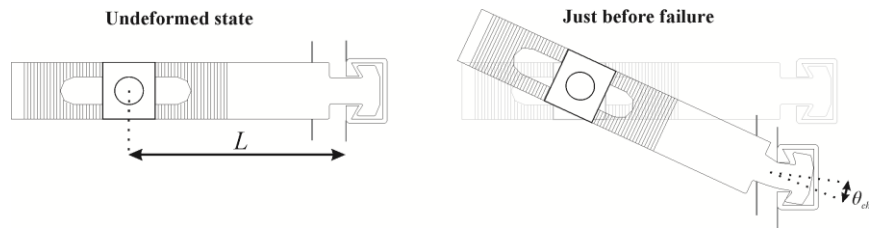

Figure 2.4: Failure mechanism of the hammer-head strap connection with strong channels

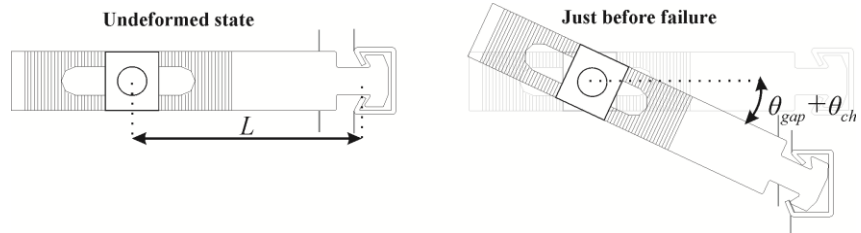

Figure 2.5: Failure mechanism of the hammer-head strap connection with weak channels

2.2.2 Design - general

For seismic loading, deformation capacity in shear and out of plane resistance of the hammer-head strap connections should be checked.

In the direction perpendicular to the panel plane the design forces in the panel-to-structure connections should be calculated as suggested by EC8 (4.3.5.2 – verification of non-structural elements). Out of plane resistance as well as shear deformation capacity of hammer head strap connection should be proved by experimental testing.

In the direction parallel to the plane of the panels, weak interaction between the panel and the bare frame may be expected until certain deformation threshold is exhausted. Until this deformation limit is reached, the system behaves essentially as isostatic and relatively simple structural models can be used, basically neglecting the structure-to-cladding interaction. The relevant design parameters for hammer-head connections are given in Section 2.2.3.

After the deformation limit was reached, more complex model should be used considering the interaction between the panels and the bare structure through the fastening system or different cladding system should be chosen. The relevant design parameters for hammer-head connections are given in Section 2.2.4.

2.2.3 Design based on the simplified model, neglecting panel-to-structure interaction

Two checks shall be done:

- Deformation capacity of the connection when loaded in shear shall be adequate (Section 2.2.3.1)
- Closing of the gap between a beam and a panel should be controlled (Section 2.2.3.2)

2.2.3.1 Deformation capacity control

Deformation capacity of the hammer-head strap connection when loaded in shear depends on the geometry of the main components of connection and deformability of the

strap or the channel, depending on the type of the failure mechanism (Figures 2.4 and 2.5). It should be estimated in the following way:

- a) If strong channels are used, the ultimate displacement of the connection when loaded in shear can be estimated as:

$$d_u = (\theta_{gap} + \theta_{st})L$$

θ_{gap} rotation of the strap due to allowances within the channel taking into account also the production and erection tolerances of the panel

θ_{st} rotation of the strap due to the flexural deformations of the strap at the narrowing just under the head, which can be estimated as ultimate curvature multiplied by the length of the narrowing

L distance between the bolt and the channel mounted in the panel (see also Figure 2.4)

- b) If weak channels are used, the ultimate displacement of the connection when loaded in shear can be estimated as:

$$d_u = (\theta_{gap} + \theta_{ch})L$$

θ_{gap} rotation of the strap due to the tolerances within the channel

θ_{ch} rotation of the strap due to the deformations of the channel mounted in the panel (should be evaluated by Finite Element analysis or experimentally verified, in both cases under cyclic action)

L distance between the bolt and the channel mounted in the panel (see also Figure 2.5)

2.2.3.2 Gap closure control

The minimal gap should be equal to L_{gap}

$$L_{gap} \geq L \left(1 - \sqrt{1 - \left(\frac{d_u}{L} \right)^2} \right),$$

where the distances L and L_{gap} are marked in Figure 2.6 and d_u is defined in section 2.2.3.1.

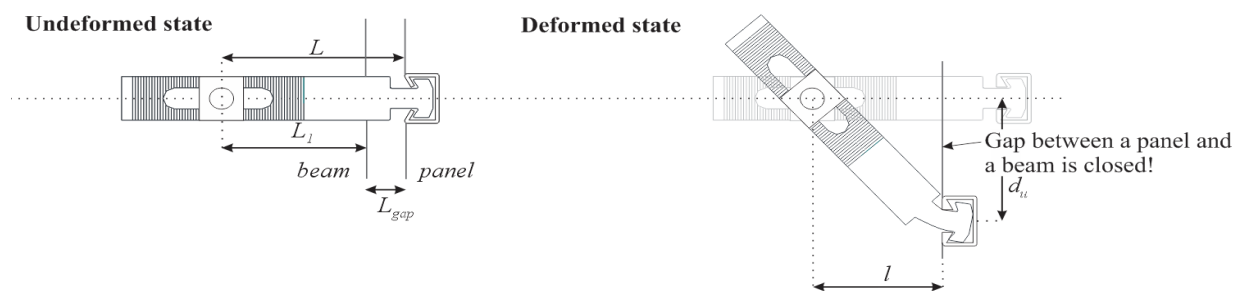

Figure 2.6: Closing of the gap between a panel and a beam

2.2.4 Design based on the refined model considering panel-to-structure interaction

The design procedures and parameters shall be based on the experimental data for cyclic tests:

- Hysteretic response envelope is given to define stiffness, deformation and strength properties (section 2.2.4.1)
- Hysteretic behaviour model is given in 2.2.4.2

2.2.4.1. Hysteretic response envelope

Hysteretic response envelope of the shear behaviour of hammer-head strap connections can be idealized as suggested in Figure 2.7. Three characteristic points are recognized.

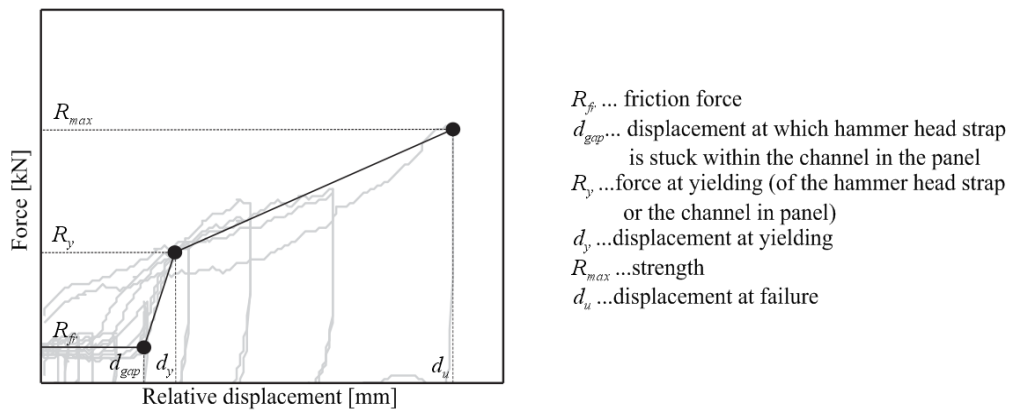

Figure 2.7: Calibrated hysteretic model for hammer-head strap connections

The characteristic points of the force-displacement response envelope of a hammer head strap connection with strong channels can be evaluated using the following expressions:

$$R_{fr} = \frac{M_{fr}}{L}$$

$$R_y = \frac{[M_{y,N} + d_y P + M_{fr}]}{\sqrt{L^2 - d_y^2}}$$

$$R_{max} = \frac{[M_{pl,N} + d_u P + M_{fr}]}{\sqrt{L^2 - d_u^2}}$$

$$d_{gap} = \theta_{gap} L$$

$$d_y \approx d_{gap}$$

$$d_u = (\theta_{gap} + \theta_{st})L$$

M_{fr} moment in the bolt (can be estimated as the tightening torque T_b)

L distance between the bolt and the channel mounted in the panel (see also Figure 2.4)

$M_{y,N}$ flexural resistance of the hammer head strap at the narrowing just under the head taking into the account axial force N

- $M_{pl,N}$ flexural resistance of the hammer head strap at the narrowing just under the head taking into the account axial force N
- P force in the direction perpendicular to the panel plane
- θ_{gap} rotation of the strap due to the tolerances within the channel
- θ_{st} rotation of the strap due to the flexural deformations of the strap at the narrowing just under the head (see also Figure 2.4), which can be estimated as ultimate curvature multiplied by the length of the narrowing

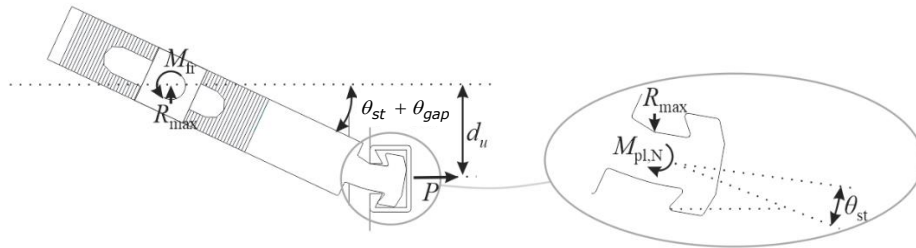

Figure 2.8: Failure mechanism of hammer head strap connections with strong channels

The characteristic points of the force-displacement response envelope of a hammer-head strap connection with weak channels can be evaluated using the following expressions:

$$R_{fr} = \frac{M_{fr}}{L}$$

$$R_y = \frac{\left[\frac{1}{2} R \sqrt{1 - \left(\frac{d_y}{L} \right)^2} (R_{ch,y} - P) + d_y P + M_{fr} \right]}{\sqrt{L^2 - d_y^2}}$$

$$R_{max} = \frac{\left[\frac{1}{2} R \sqrt{1 - \left(\frac{d_u}{L} \right)^2} (R_{ch,u} - P) + d_u P + M_{fr} \right]}{\sqrt{L^2 - d_u^2}}$$

$$d_{gap} = \theta_{gap} L$$

$$d_y \approx d_{gap}$$

$$d_u = (\theta_{gap} + \theta_{ch}) L$$

- M_{fr} moment in the bolt (can be estimated as the tightening torque T_b)
- L distance between the bolt and the channel mounted in the panel (see also Figure 2.5)
- $R_{ch,y}$ out of plane yield resistance of the channel (normally specified by the producer)
- $R_{ch,u}$ out of plane resistance of the channel (normally provided by the producers)
- R distance marked in Figure 2.9
- P force in the direction perpendicular to the panel plane
- θ_{gap} rotation of the strap due to the tolerances within the channel

θ_{ch} rotation of the strap due to the deformations of the channel mounted in the panel (should be evaluated by FE analysis or experimentally verified)

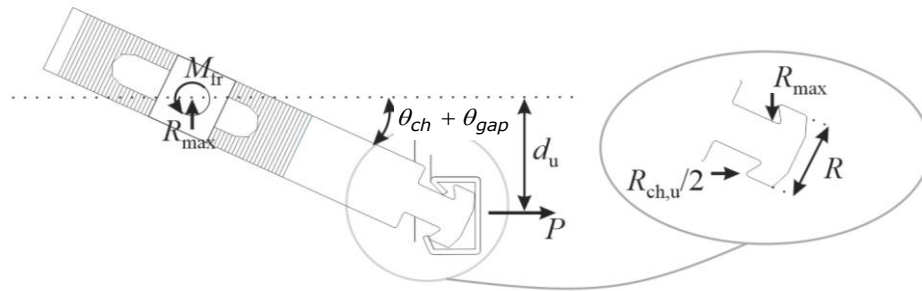

Figure 2.9: Failure mechanism of hammer head strap connections with weak channels

2.2.4.2. Hysteretic behaviour model

Hysteretic response of a hammer-head strap connection can be modelled by using a combination of three different responses: elasto-plastic; gap and hysteretic (Figure 2.10), which are usually included in the commercial programmes for nonlinear analysis. An example of the use of such a model is presented in Fig. 2.11, where analytical response is compared to the experimental one.

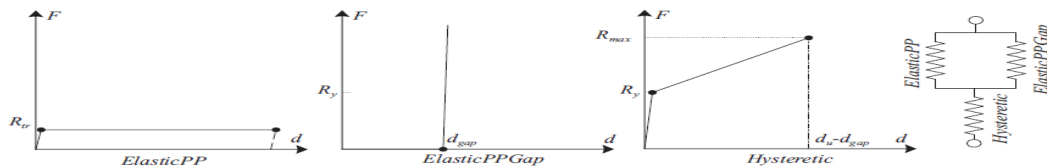

Figure 2.10: Combination of three different force-displacement responses

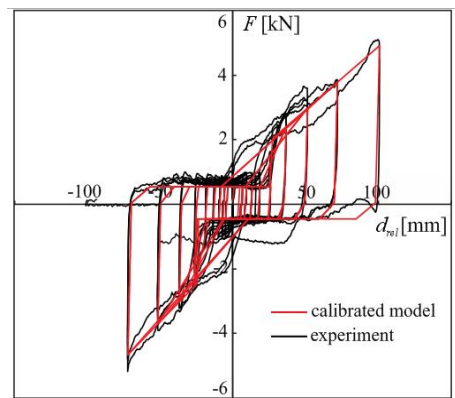

Figure 2.11: Calibrated hysteretic model for hammer-head strap connections

2.2.5 Other aspects

If panels are not anchored but only seated on the foundation beam, the relative displacements in the panel-structure connections are more difficult to model: nonlinear dynamic analysis with appropriate models allowing for rocking behaviour should be performed

In the discussion of the hammer-head connection it was assumed that the bolt is fastened with the torque prescribed by the producers. If this torque is applied, it is unlikely that the bolt will slide along the channel. If we diminish this torque and allow for sliding, the deformation capacity of the connection would obviously increase. From the

point of view of the proposed design methodology (see DGB) this would be beneficial. Since it is expected that seismic action on the connection at the strong earthquake is certainly larger than in the case of other actions, it is recommended to find the level of torque, which is still acceptable for other actions, but allows sliding at the seismic action.

2.3 Cantilever box connection

2.3.1 General description

Cantilever box connections consist of a vertical channel, which is mounted in the columns and a special steel element which is mounted in the panel. The two components are then connected by means of a single bolt (Figure 2.12). Cantilever connections are most often used for fastening of horizontal panels to the beams at the top corners of a panel.

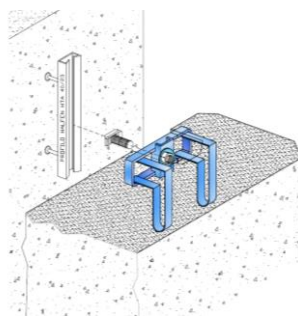

Figure 2.12: Schematic presentation of the cantilever connection assembly

The behaviour of the cantilever connections, when loaded in shear, is schematically presented in Figure 2.13. At first the bolt slides along the profile. The resistance of the connection is equal to the friction force between the components. At some displacement (see section 2.3.3.3) the bolt reaches the end of the profile. At that point the stiffness of the connection increases. Finally the channel fails and the bolt is pulled out of the channel.

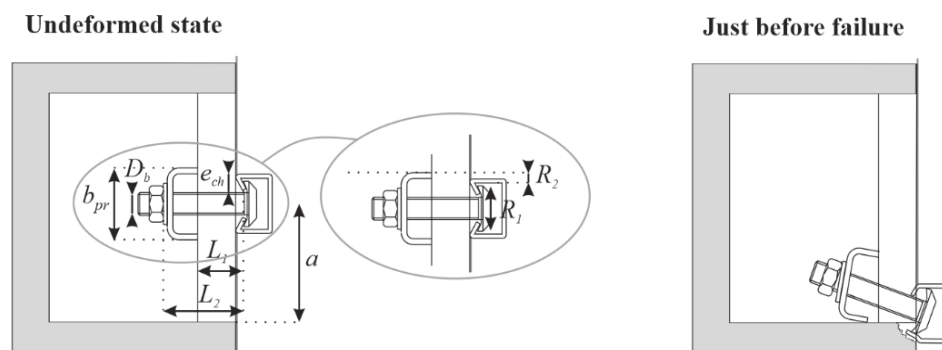

Figure 2.13: Failure mechanism of the cantilever connection

2.3.2 Design - general

For seismic loading, the deformation capacity in shear and the out of plane resistance of the cantilever box connection should be checked.

In the direction perpendicular to the panel plane the design forces in the panel-to-structure connections should be calculated as suggested by EC8 (4.3.5.2 – verification of

non-structural elements). The out of plane resistance as well as the shear deformation capacity of cantilever box connection should be proved by experimental testing.

In the direction parallel to the plane of the panels, weak interaction between the panel and the bare frame may be expected until certain deformation threshold is exhausted. Until this deformation limit is reached, the system behaves essentially as isostatic and relatively simple structural models can be used, basically neglecting the structure-to-cladding interaction. The relevant design parameters for cantilever box connections are given in Section 2.3.3.

After the deformation limit was reached, a more complex model should be used considering interaction between the panels and the bare structure through the fastening system or different cladding system should be chosen. The relevant design parameters for cantilever box connections are given in Section 2.3.4.

2.3.3 Design based on the simplified model, neglecting panel-to-structure interaction

The deformation capacity of the connection when loaded in shear shall be adequate. The deformation capacity of the cantilever box connection when loaded in shear depends on the geometry of the main components of connection (Figure 2.13). It should be estimated in the following way:

$$d_{gap} = a - \frac{D_b}{2}$$

D_b bolt diameter

a distance marked in Figure 2.13

2.3.4 Design based on the refined model considering panel-to-structure interaction

The design procedures and parameters shall be based on the experimental data for cyclic tests:

- Hysteretic response envelope is given to define stiffness, deformation and strength properties (section 2.3.4.1)
- Hysteretic behaviour model is given in 2.3.4.2

2.3.4.1. Hysteretic response envelope

The hysteretic response envelope of the shear behaviour of cantilever connections can be idealized as suggested in Fig. 2.14. Two characteristic points are recognized.

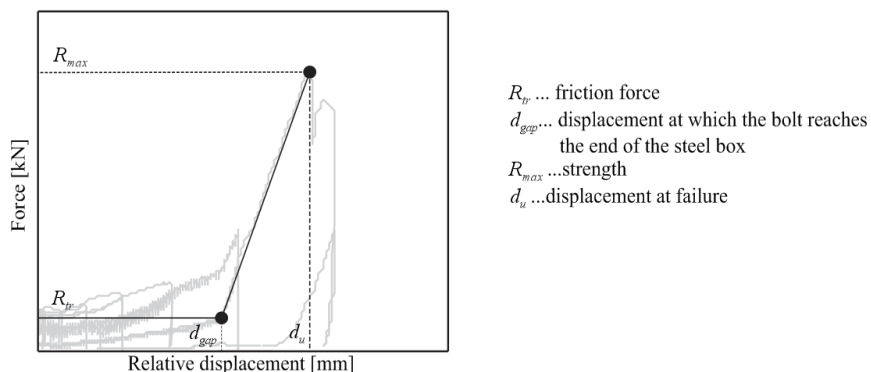

Figure 2.14: Hysteretic response envelope definition for cantilever connections

The characteristic points of the force-displacement response envelope of a cantilever connection with strong channels can be evaluated using the following expressions:

$$R_{fr} = P_v k_{fr}$$

$$R_{max} = \frac{R_{ch,u} (r_1 + r_2)}{2I_1}$$

$$d_{gap} = a - \frac{D_b}{2}$$

$$d_u = a - \frac{D_b}{2} + e_{ch}$$

P_v axial force in the bolt due to the tightening torque

k_{fr} friction coefficient between panel and beam

$R_{ch,u}$ out of plane resistance of the channel

D_b bolt diameter

a distance marked in Figure 2.13

e_{ch} distance marked in Figure 2.13

$$r_1 = R_1 \sqrt{1 - \frac{L_1 (b_{pr} - D_b)}{2L_2}}$$

$$r_2 = \frac{L_1 (b_{pr} - D_b)}{2L_2} + R_2$$

$$I_1 = L_1 \sqrt{1 - \left(\frac{b_{pr} - D_b}{2L_2} \right)^2}$$

$R_1, R_2, b_{pr}, L_1, L_2$ are marked in Figure 2.13.

2.3.4.2. Hysteretic behaviour model

The hysteretic response of a cantilever box connection can be modelled by using a combination of three different responses: elasto-plastic, gap and elastic (Figure 2.15). All three responses are usually included in the commercial programmes for nonlinear analysis. An example of a use of such model is presented in Fig. 2.16, where the analytical response is compared to the experimental one.

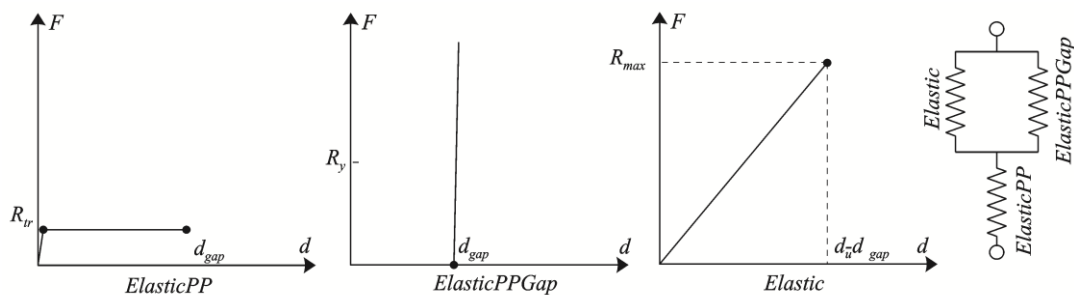

Figure 2.15: Combination of three different force-displacement responses

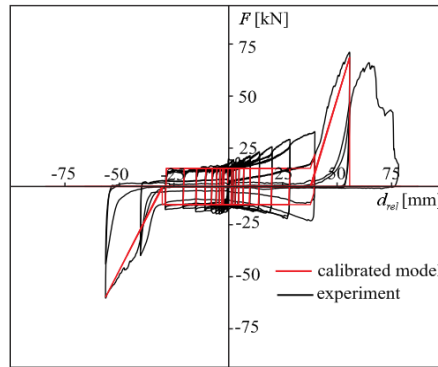

Figure 2.16

2.4 Steel angle connections

2.4.1 General description

The steel angle connection consists of two steel channels which are mounted in a beam (or column) and a panel and a steel angle which is fastened to the channels by means of bolts (see Figure 2.17).

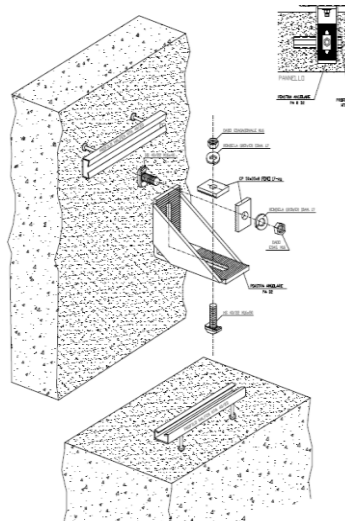

Figure 2.17: Schematic presentation of the steel angle connection assembly

Behaviour of the steel angle connections, when loaded in shear, is schematically presented in Fig. 2.18. Compression forces are induced at one edge of the angle and tension forces are induced in the bolt. The connection fails due to the failure of the channel mounted in the panel. The bolt is then pulled out of the channel.

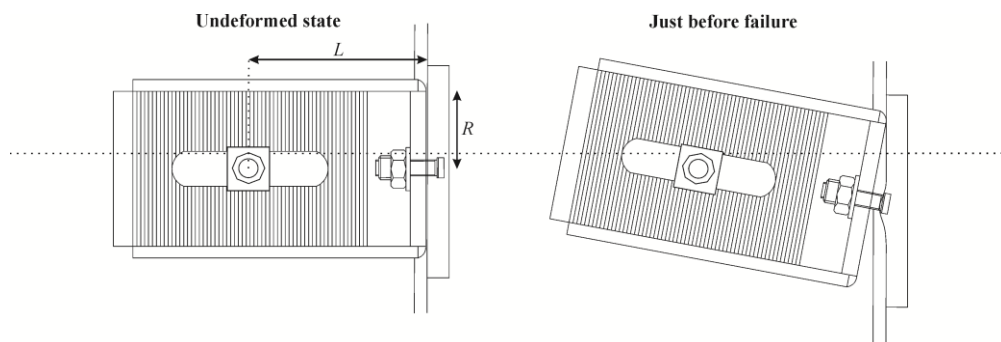

Figure 2.18: Failure mechanism of steel angle connections

2.4.2 Design - general

For seismic loading, the shear and out of plane resistance of the connection shall be checked. Stiffness of the steel angle connection is not negligible and it should be taken into the account in the global analysis of the structure. In the most simplified situation, the steel angle connections could be considered as pinned joint.

In the direction perpendicular to the panel plane the design forces in the panel-to-structure connections should be calculated as suggested by EC8 (4.3.5.2 – verification of non-structural elements). The out of plane resistance as well as the shear deformation capacity of cantilever box connection should be proved by experimental testing.

2.4.3 Design based on the refined model considering panel-to-structure interaction

2.4.3.1 Hysteretic response envelope

The hysteretic response envelope of the shear behaviour of steel angle connections can be idealized as suggested in Fig. 2.19. Two characteristic points are recognized.

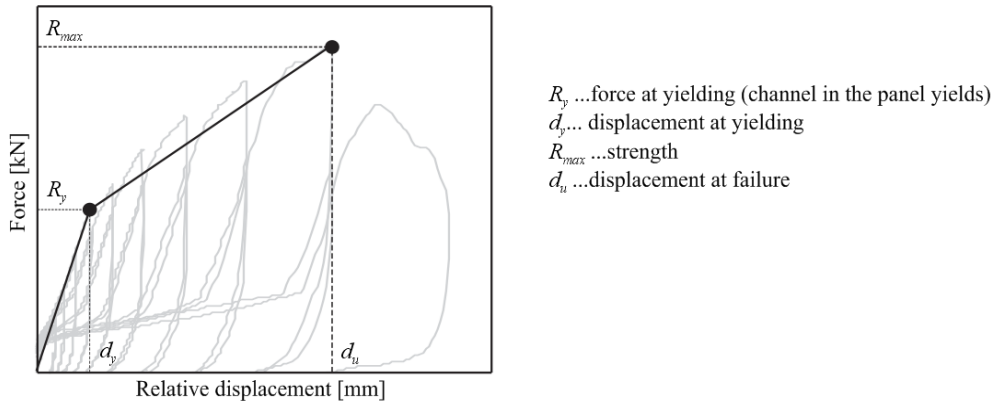

Figure 2.19: Hysteretic response envelope definition for steel angle connections

The characteristic points of the force-displacement response envelope of a steel angle connection with strong channels can be evaluated using the following expressions:

$$R_y = \frac{\left[\frac{1}{2} R \sqrt{1 - \left(\frac{d_y}{L} \right)^2} (R_{ch,y} - P) + d_y P + M_{fr} \right]}{\sqrt{L^2 - d_y^2}}$$

$$R_{max} = \frac{\left[R \sqrt{1 - \left(\frac{d_u}{L} \right)^2} (R_{ch,u} - P) + d_u P + M_{fr} \right]}{\sqrt{L^2 - d_u^2}}$$

$$d_y = \sqrt{e_{ch,y}(2L - e_{ch,y})}$$

$$d_u = \sqrt{e_{ch,u}(2L - e_{ch,u})}$$

M_{fr} moment in the bolt (can be estimated as the tightening torque T_b)

R distanced marked in Figure 2.18

- L distance between the bolt and the channel mounted in the panel (see also Figure 2.18)
- P force in the direction perpendicular to the panel plane
- $R_{ch,y}$ out of plane yield resistance of the channel (normally specified by the producer)
- $e_{ch,y}$ out of plane deformation of the channel at yielding (evaluated by FE analysis or experimental testing)
- $e_{ch,u}$ out of plane deformation of the channel at failure (evaluated by FE analysis or experimental testing)

2.4.3.2. Hysteretic behaviour model

Hysteretic response of a steel angle connection can be modelled by using a hysteretic response as shown in Figure 2.20. These models are usually included in the commercial programmes for nonlinear analysis. An example of a use of such model is presented in Figure 2.20, where analytical response is compared to the experimental one.

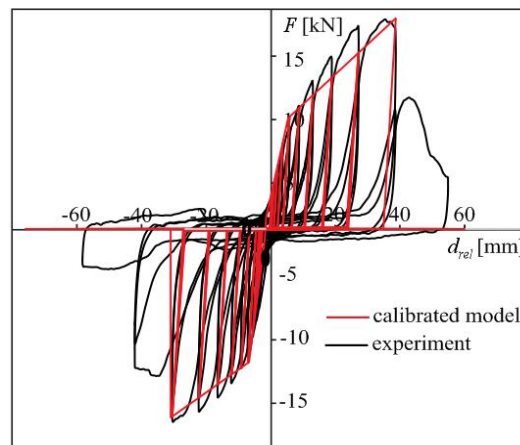

Figure 2.20: Calibrated hysteretic model for steel angle connections

3. ISOSTATIC SYSTEMS

In order to ensure the pure frame behaviour of the resisting structure, the connection system of the wall panels shall actually allow without reaction the large displacements of the frame structure under seismic action, except for possible minor unintended reaction effects due to friction or sealing. In this case one shall adopt sliding connection devices with adequate capacities (such as ± 150 mm or greater) or pinned connectors for free rotations.

It should be stated beforehand that at present the isostatic systems, adapted for seismic purposes as described below, are of easy application with a sufficient reliability.

- The cantilever solution (Figure 3.1b) has the base supports described in Clause 4.2 and at the upper side the available sliding connections described in 3.2.
- The pendulum solution (Figure 3.1a) in principle has a fully reliable behaviour with the use at the base of the rotating devices of Clause 3.3 and the shear keys of Clause 4.3.2 at the upper side.
- The rocking solution (Figure 3.1c) has the panel base simply seated on the supporting element and the shear keys at the upper side.
- For the hanging and seated solutions shown of Figure 3.2 for the horizontal panels, the same considerations stated above for the vertical cantilever panels can be made.

3.1 Structural arrangements

Considering that the vertical panels are placed over the foundation beam, to which they transmit their weight, and are supported horizontally by the roof beam with connections placed close to the top, the arrangements to obtain an isostatic connection system for these panels are those shown in Figure 3.1. The first solution adopts hinged lower and upper supports so to have a pendulum behaviour for any single panel (see Figure 3.1a). The second solution adopts fixed (pinned) supports at the base of the panels and one or two sliding connections to the structure at the upper position so to have a cantilever behaviour uncoupled from the structure (see Figure 3.1b). The third solution adopts a simple seating of the panels on bearings placed at the two edges of the base side together with a hinged connection to the structure at the upper position so to have a rocking behaviour for large displacements (see Figure 3.1c). For all the three solutions, in the out-of-plane direction the panels are supported with an isostatic pendulum scheme (see Figure 3.1d).

In the pendulum arrangement (Figure 3.1a), for a given top displacement d the adjacent vertical sides of the panels display a relative slide of bd/h where h is the height of the upper support and b is the width of the panels. In the meantime the two adjacent sides get closer by a minor quantity that requires in any case a free spacing between the panels (few millimetres) closed by the sealant. The sealing between the adjacent panels may give a minor reaction to the motion that can be neglected (see 3.4). The rotating base supports of the panels may display a friction reaction to the motion that has very small (negligible) dissipative effects on the seismic response. Since only vertical compression forces are expected at the base supports, these can consist of simple seatings able to provide only an unilateral restraint in $-z$ direction. To allow for thermal expansion, the upper supports may be made of one central or two lateral vertical slide channel bars able to transmit only horizontal forces. The arrangement matrix is given in Table 3.1.

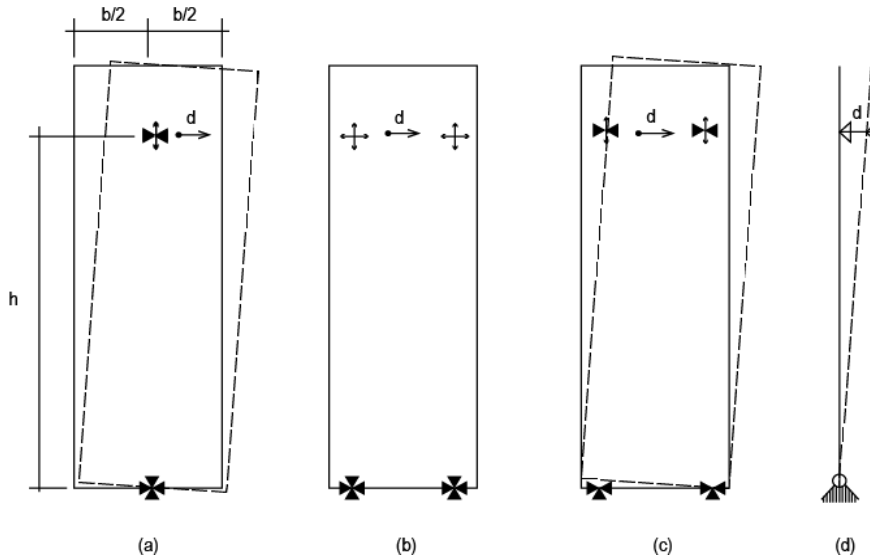

Figure 3.1

	A	B	C	D	E	F
x	f	/	f	/	0	0
y	f	/	f	/	0	0
z	f	/	s	/	0	0

Table 3.1

The cantilever arrangement (Figure 3.1b) keeps the panels still during the motion of the structure because of the horizontal slide channel bars placed at the upper position. To allow for thermal expansion vertical channel bars may be coupled to the horizontal ones (one in the beam and one in the panel). Sensible friction effects may arise due to the contemporary orthogonal forces caused by the biaxial vibratory motion. The base support of the panels can be provided with reinforcing bars protruding from the bottom and anchored by bond within corrugated sleeves inserted in the foundation and filled with no-shrinking mortar. Other types of dry mechanical connections may be adopted for the base support of the panels. The arrangement matrix is given in Table 3.2.

	A	B	C	D	E	F
x	f	f	s	s	0	0
y	f	f	f	f	0	0
z	f	f	s	s	0	0

Table 3.2

The rocking arrangement (Figure 3.1c) consists of the seating of the panels on the foundation through unilateral bearings that work only in compression. The two edges of the base side of the panel alternatively rise up during the rocking motion and should be properly reinforced against spalling. Small horizontal actions applied to the upper connection of any single panel are equilibrated by its weight until they are $\leq Gb/(2h)$, where G is the weight of the panel, b is its width and h is the height of the applied horizontal action. In this condition the panels behave as integrated in the structure that becomes a dual wall-frame system with a much higher global stiffness. Under seismic

action therefore the reacting system receives an initial high horizontal impulsive force that decreases when that limit is overcome and the panels begin to rock, behaving as isostatic system. In the rotated position the panel, seated in its edge active bearing, provides a stabilizing constant horizontal force $H=Gb/(2h)$. At the reverse motion the panel seats back again on the two base lateral bearings restoring its initial stable equilibrium. The analysis of such vibration motion requires calculation codes with refined algorithms for the solution of the non linear equations. A simplified approach for the structural analysis is given in Clause 3.3 of DGB. The arrangement matrix is given in Table 3.3.

	A	B	C	D	E	F
x	f*	f*	f	f	0	0
y	f	f	f	f	0	0
z	f	f	s	s	0	0

*working alternatively

Table 3.3

The horizontal panels are connected externally to the adjacent columns to which they transmit their weight, being restrained horizontally by the same connections. The lower panels can be seated directly with their weight on the foundation elements.

Following an alternative solutions, the horizontal panels can be seated one over the other, taking all their weights directly to the foundation and transmitting to the adjacent columns only the horizontal orthogonal actions due to their mass. In this case one has a lower reliability of the model because of the higher uncertainties of the friction longitudinal behaviour of the mutual joints under seismic conditions. So this alternative solution is not recommended.

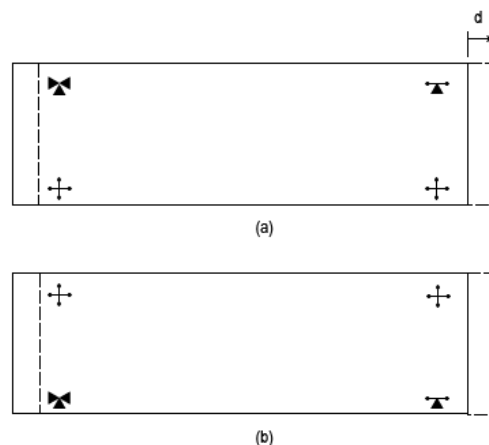

Figure 3.2

In this document only the isostatic hanging (see Figure 3.2a) and seated (see Figure 3.2b) equivalent solutions are considered. The superimposed panels shall have a free spacing at the joint between the adjacent sides to allow the relative slide motion without friction. This joint is sealed with proper material (silicone) that may introduce a minor reaction effect. Any single panel is provided by two upper or lower vertical supports placed at the ends and fixed to the columns. One of them provides also the horizontal restraint in the plane of the panel. To allow for thermal expansion, the opposite one gives no horizontal reaction in the plane of the panel. At the opposite lower or upper side two couples of sliding connections are placed allowing the free horizontal and vertical

displacements. All the four corner connections provide a fixed horizontal support orthogonal to the panel. The arrangement matrixes are given in Tables 3.4 and 3.5.

	A	B	C	D	E	F
x	s	s	f	s	0	0
y	f	f	f	f	0	0
z	s	s	f	f	0	0

Table 3.4

	A	B	C	D	E	F
x	f	s	S	s	0	0
y	f	f	F	f	0	0
z	f	f	S	s	0	0

Table 3.5

3.2 Sliding devices

3.2.1 General

The sliding devices, such as fixed channel bars with internal moving head slides, shall allow the free longitudinal alternate displacements without reactions. Tangling effects may result in unexpected integrated behaviour: they have to be avoided in all cases. The slides shall be proportioned with the due play with respect to the channel without sharp corners and shaped in such a way to avoid seizure especially under impulsive actions. Contact steel-to-steel shall be avoided and special inner coating of the channel bar shall be provided with Teflon or other slippery materials.

An initial type testing shall be performed submitting some devices to monotonic and cyclic longitudinal actions for different values of the transverse force (3D effects) consistently with the joint arrangement expected in the structure and with the geometrical allowances proportioned considering also the production and installation tolerances in the overall façade. The proper functioning shall be checked all over the range of the expected displacements.

Particular care shall be given to the installation of the sliding devices in order to keep the positioning deviations within the admissible linear and angular tolerances of the joint. For example, for the vertical panels of Figure 3.1 the correct positioning of the channel bars of the upper connections shall be ensured within the required verticality and/or horizontality tolerances.

In any case the sliding devices of concern shall provide an effective connection between panel and structure in the direction orthogonal to the panel, without excessive out of plane plays. In the overall arrangement of the panels, all possible hammering phenomena between adjacent panels and panel to structure shall be prevented.

Specific checks of the geometrical compatibility of the displacements shall be addressed to the corners of the building where orthogonal panels are jointed, with possible interposed angle elements.

3.2.2 Dimensioning

Figure 3.3 shows a type of sliding device for connecting a vertical panel to the upper beam. The channel bar short (1) or long (2) is fixed to the beam. A fixing gear (3) is attached to the panel in a special pocket, bolted to counter-plate (11). A fastener (4) is placed to connect the two parts, where its grooved head slide is inserted in the lips of the channel bar to provide a bilateral transverse support while it remains free to slide in the longitudinal direction. At the other end the fastener is attached to the fixing gear with a full support that restrains displacements and rotations.

The sliding length of the channel bar is dimensioned with reference to the expected drift of the floor under seismic conditions (see DGB) amplified by 1,2 to cover the uncertainties of the calculation. The resistance verification of the connection is made with reference to the transverse force calculated with *EC8* rules on the basis of the mass of the panel. For the channel bar the rules of *PT4* can be applied. For the other parts of the device reference should be made to the technical specifications of the producer.

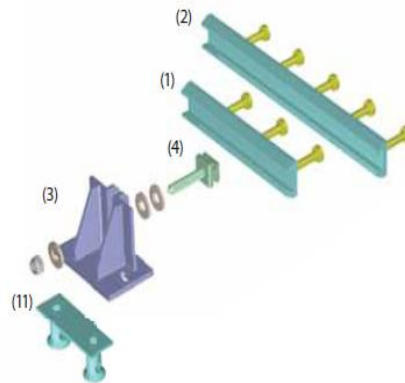

Figure 3.3

3.3 Vertical supports

3.3.1 Rotating devices

Rotating connections are mainly used at the base of vertical panels in pendulum arrangement. Figure 3.4 shows the mechanical device to be used when a resultant vertical upward (lifting) action is expected on the panel so to require a downward reaction from the connection. It is the case of the end panels of a wall, subject to a longitudinal horizontal alternate force, where the panels are connected to each other by lateral joint connectors (possibly dissipative). The quoted one is an ordinary hinge, common in steel construction, that relay its resistance on the shear strength of the pin and to the bearing action of the lateral plates. If no upward actions are expected on the panel, a simple support on a steel pad that concentrates the compressions in a small print can be used (Figure 3.5). The plastic settlements of the pad allows the small relative rotations of the bearing contact surfaces. Proper lateral restraints (stoppers) shall be provided for the shear action.

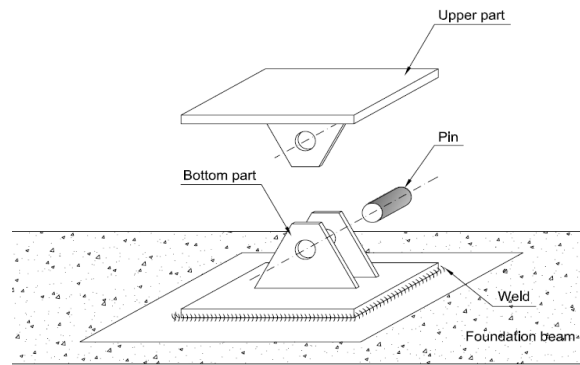

Figure 3.4

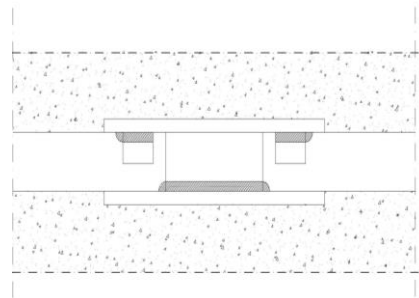

Figure 3.5

3.3.2 Supports with steel brackets

Strong steel brackets are conceived to support the horizontal suspended panels connecting them to the columns. They are made with traditional steel profiles, that may be filled with concrete to increase their stiffness. Bracket connections are conceived to carry the gravity load of the panel, and are usually placed in two positions in a row. A recess in the panel or/and an inclined contact surface may prevent the panel out-of-plane displacement. Even if they do not usually allow the panel in-plane displacement, special features may be adopted to make them slide horizontally for thermal expansion. The efficiency of the sliding mechanism shall be experimentally verified through monotonic and cyclic tests, in accordance with Clause 3.2.

Figure 3.6 shows a type of bearing bracket device provided with an adjustable steel bolt for the support of horizontal panels, connected to the column. The bracket is simply inserted in a recess left in the column and the panel, which is provided with a hosting groove, is simply placed on top of the bolt.

For the bearing capacity of the device, reference should be made to the technical specifications of the producer that are usually based on experimental testing. The out-of-plane resistance verification of the connection is made with reference to the transverse force calculated with *EC8* rules on the basis of the mass of the panel.

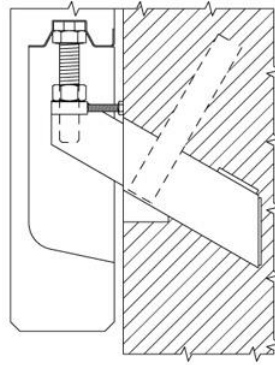

Figure 3.6

3.4 Effects of silicone sealing

Silicone sealant is a natural completion material of precast panels. It is universally used to fill and close the joints in between panels and between panels and other components. It is applied only at the external side or at both external and internal sides. Silicone sealant is not a structural product and, within an isostatic connection system, it should allow free drifts of the joint without damages, keeping its waterproof function. However, a reaction of the long silicone sealant strips to the relevant drifts under seismic action arises, affecting at a certain level the response of the structure. The results of a specific experimental campaign performed on silicone at low speed and neglecting long-term effects are used to characterize the mechanical behaviour of the material. Since they show a large scatter, the considerations that can be deduced have a general and indicative value. The stress-strain curves obtained from monotonic and cyclic tests are shown in Figure 3.7.

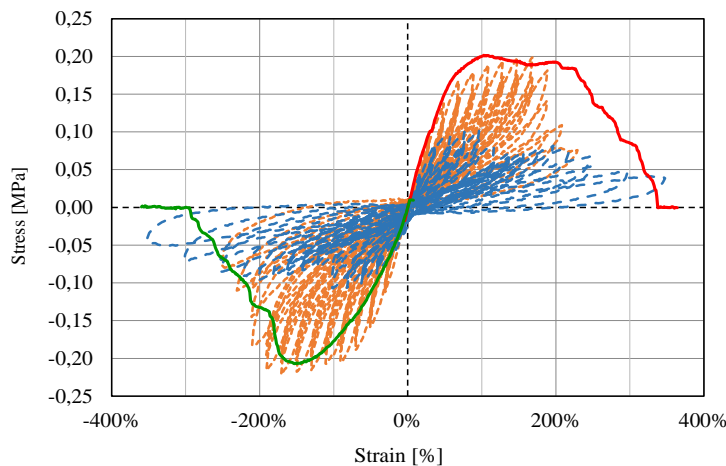

Figure 3.7

The behaviour is characterised by a tangential upper bound stress τ_s up to 0,25 MPa and an average tangential Young modulus G of about 0,25 MPa. The elastic branch develops up to about 70-100% of strain with a pseudo-plateau up to about 200% of strain, after which silicone begins to tear and the resistance rapidly decreases. Its cyclic behaviour is characterized by very strong pinching.

The presence of silicone sealant can influence the serviceability limit state and increase the load on the panel connections. It is not suitable to sustain large structure drifts such as those associated with ultimate limit state for frame precast structures, since it tends

to failure for shear strain larger than 200%. Its stiffening contribution is, however, limited and not reliable, since the mechanical characteristics of the product may largely vary. Therefore, it is suggested to consider the effect of the presence of silicone sealant only for the calculation of the actions on the panel connections in SLS. It is suggested to neglect its stiffening contribution when considering the possible beneficial effect on the seismic behaviour of the whole structure.

4. INTEGRATED SYSTEMS

In the integrated system the connections of each panel are arranged with a hyperstatic set of fixed supports. In this Chapter the term “fixed” is used interchangeably with the term “pinned” and denotes connections with restrains in displacements only, while rotations are allowed. With this arrangement of connections the panels participate to the seismic response of the structure within a dual wall-frame system which has a much higher stiffness and a lower energy dissipation capacity compared to a pure frame and this leads to a structural seismic response with higher forces and lower displacements. The panel connections shall be proportioned by consequence, not with a local calculation based on the mass of the single panel, but from the analysis of the overall structural assembly with its global mass. Specific guidelines for the design of panel walls with integrated connections are given in Chapter 4 of *DGB*.

The adoption of an integrated system has also some side effects such as those of a strong engagement of the floor diaphragm action necessary to take the inertia forces of the floors to the lateral resisting walls.

4.1 Structural arrangements

A typical hyperstatic arrangement of connections is shown in Figure 4.1 for vertical panels. Four fixed fastenings are used, one for each corner, the lower two attached to the bottom beam, the upper two attached to the top beam. The corresponding arrangement matrix is given in Table 4.1. With this arrangement any panel acts as a vertical beam clamped at both ends.

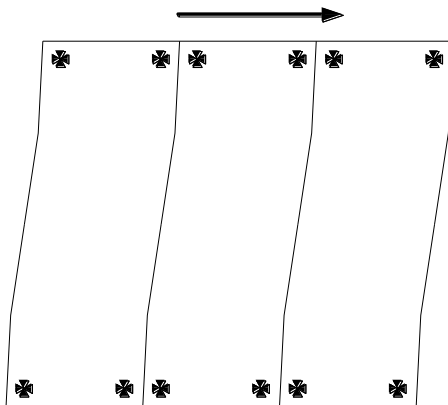

Figure 4.1

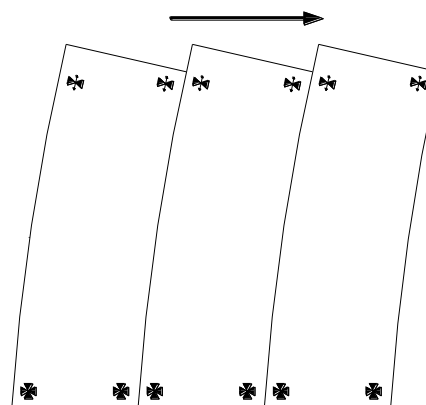

Figure 4.2

For large size panels thermal fluctuations might induce significant axial forces to the panels if their expansion is prevented. These forces can lead to local damages and widespread cracking and also to out-of-plane buckling. In such cases, thermal forces must be considered in the design of the panels.

In order to allow the free vertical thermal expansion of the panel, the two upper fixed fastenings can be replaced by as many vertically sliding connections. Figure 4.2 shows this arrangement, in which each panel acts as a vertical cantilever beam clamped at its bottom and pinned at its top. The corresponding arrangement matrix is given in Table 4.2. For the same horizontal top action, this arrangement leads to double the vertical reactions of the lower connections compared with the arrangement of Figure 4.1. It is noted that the two upper corner connections can be replaced by only one central connection.

Figure 4.3 shows a hyperstatic arrangement of connections for horizontal panels. Four fixed fastenings are used, one for each corner, attached to the contiguous columns. The

corresponding arrangement matrix is the same of the one given in Table 4.1. With this arrangement any panel acts as a horizontal beam clamped at its ends.

	A	B	C	D	E	F
x	F	f	f	f	0	0
y	F	f	f	f	0	0
z	F	f	f	f	0	0

Table 4.1

	A	B	C	D	E	F
x	F	f	f	f	0	0
y	F	f	f	f	0	0
z	F	f	s	s	0	0

Table 4.2

In case of horizontal panels, the fixed connections applied to the columns affect significantly their deformation during earthquakes, inducing the development of high local forces. Additionally, the insertion of adequate fastening devices in the reduced dimensions of the columns without endanger their resistance could be a difficult construction problem. For these reasons horizontal panel arrangement in integrated systems are not recommended.

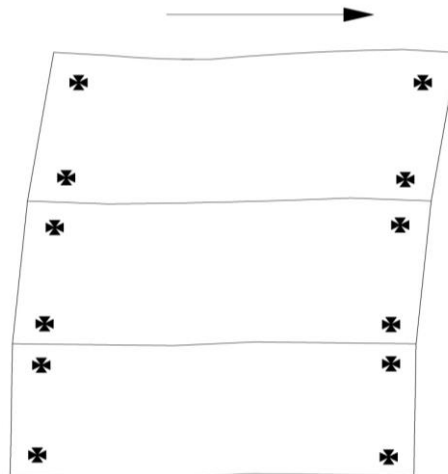

Figure 4.3

4.2 Base supports

Three types of base fixed connecting mechanisms are treated below:

- connections with protruding bars;
- connections with bolted shoes;
- connections with bolted plates.

Independently from the type of connection, a gap is typically left during construction between the panel and the supporting beam, which is filled with high strength, non-shrinking grout after mounting the panels. The purpose of this bed of mortar is to form a uniform contact between the panel and the supporting beam, necessary to ensure friction and prevent sliding. Special holding provisions are required to ensure the proper positioning of the panels and to ensure their stability during erection.

Severe cracking of this embedding was observed during experiments for intense loading and large thickness of the grout. For this reasons, the thickness of this bed of mortar should not exceed 50 mm, while it is suggested to use fibre-reinforced grout, which showed much better behaviour.

Panels with integrated connections behave as clamped at their ends. For this reason, and taking under consideration their large in-plane stiffness, significant internal forces can develop during strong earthquakes. Openings in the panels reduce their local strength and, therefore, appropriate verifications should be performed to ensure the ability of the reduced cross sections of the panel at the place of the openings to transmit the large shear forces and moments.

In addition, proper reinforcement, specifically continuous steel ties, horizontal or vertical, should be provided around the openings, similar to the reinforcement placed around openings in ductile shear walls. As a minimum, these ties should satisfy clause 9.10 of *EC2*.

4.2.1 Connections with protruding bars

4.2.1.1 General

This type of connections can be executed using steel bars (e.g: reinforcement rebars) protruding from the panels into the beams or vice versa. In both cases, waiting corrugated sleeves are provided in the opposite element for the insertion of the bars. These sleeves are filled with high strength, non-shrinking fluid mortar after erection. In Figure 4.4 the typical connection in case of bars protruding from the panel into the supporting beam is shown. In case that the connecting bars are protruding from the supporting beam into the panel, the corrugated sleeves are placed in the panels and must have holes for the injection of the grout. Special holding provisions are required to ensure the proper positioning of the panels and to ensure their stability until the hardening and the sufficient aging of the mortar.

No special requirements apply to the embedded part of the protruding steel bars. However, proper reinforcement shall be placed around the sleeves to confine the concrete around them and anchor them against pull-out. The use of smooth sleeves instead of corrugated ones is not allowed, as pull-out slip can occur at the surface of the duct.

An alternative solution would be to use mechanical couplers, as the ones applied in practice to achieve continuity of reinforcement, in order to attach the protruding part of the bars in site. Special technological provisions, depending on the adopted coupler, shall be applied to ensure the required strength of the connections. If bolted bushes are used, proper provisions should be adopted to avoid that the weakening of bars due to threading jeopardizes the strength of the connection leading to an early brittle failure. In any case, when using mechanical couplers the coupling device shall have been experimentally qualified for its effectiveness in terms of over-resistance with respect to the connected bars.

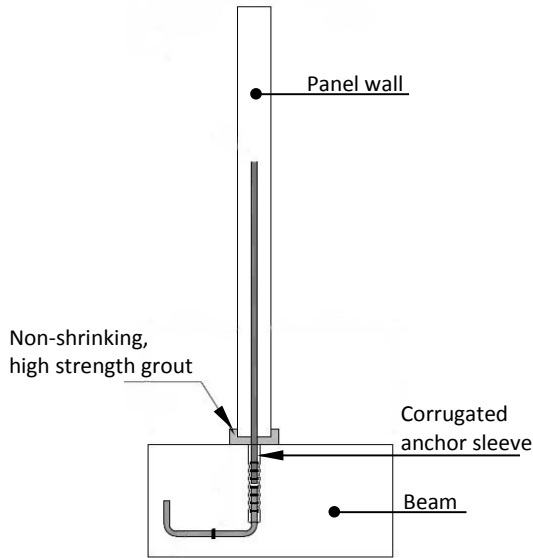

Figure 4.4

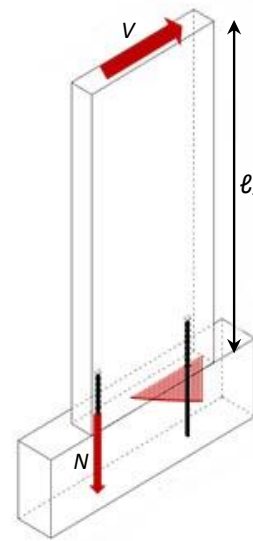

Figure 4.5

The same type of connection can be used at the upper side of the panel to fix it to a superimposed element of the structure.

4.2.1.2 Strength

Figure 4.5 shows the resisting mechanism at the panel-to-beam joint under a seismic action that applies a shear force V to the panel. The figure shows only the height of the panel up to the zero-moment point (shear length, l_s), which is equal to one half of the total height the case of Figure 4.1 and equal to the full height in the case of Figure 4.2.

The connecting bars provide the tensile strength in the tension zone, while the concrete provides the resistance in the compression zone (Figure 4.5). No special measures are usually required to prevent sliding in the horizontal direction, since the horizontal resistance provided, mainly by the friction between the panel and the beam and secondarily by the dowel action of the bars, is adequate to sustain the horizontal forces.

The possible failure modes associated with the resisting mechanism shown in Figure 4.5 are:

- Pull-out of the tension bars
- Break of the tension bars
- Permanent elongation of the tension bars due to large strains developed
- Failure of the concrete in the compression zone (not probable except in case of very high forces)
- Sliding shear failure of the panel (not probable except in case of yielded connecting bars)

The experimental investigation showed that permanent elongation of the connecting bars occurs after their yielding with several unfavourable side effects, such as:

- The panels stop being in contact with the beams. As a result, the friction resistance is lost and sliding shear failure of the panel may occur.
- The nonlinear behaviour of the connections under cyclic loading is characterized by considerable pinching.

To avoid such undesired situations, the connections shall be oversized in the sense of clause 5.11.2.1.2 of EC8. Thus, the design action-effects of the connections shall be derived on the basis of the capacity design rules. Since the application of capacity design criteria to dual wall-frame integrated systems is, in general, difficult, it is suggested that the over-proportioning of the connections is made referring to the forces deduced from a structural analysis performed with behaviour factor $q=1,5$. Guidelines for the calculation of the forces that develop in the connections are given in DGB.

4.2.1.3 Verifications

Verification against axial yielding

The following inequality shall hold:

$$N_d \leq N_{Rd}$$

where

N_d is the axial force induced to the connecting bar, calculated from a structural analysis performed with behaviour factor $q = 1,5$ as mentioned above

N_{Rd} is the axial resistance of the connecting bar calculated by

$$N_{Rd} = A_s f_{yd}$$

in which

A_s is the cross section area of the bar

$f_{yd} = \frac{f_{yk}}{\gamma_s}$ is the design yield stress of the steel of the bar

f_{yk} is the characteristic yield stress of the steel of the bar

γ_s is the safety factor for steel ($\gamma_s = 1,15$ according to EC2)

Verification against pull-out

To avoid a brittle bond failure, the anchorage length of the connecting bars shall be over-proportioned by capacity design with respect to the yielding force of the bars. The following inequality shall hold:

$$l_b u f_{bd} \geq \gamma_R A_s f_{ym}$$

where

l_b is the anchor length of the bar

$u = \pi d$ is the perimeter of the bar, d being its diameter

$f_{bd} = 0,45 \cdot f_{md}$ is the bond strength of the mortar, f_{md} being the design cylinder compressive strength

γ_R is the overstrength factor ($\gamma_R = 1,2$ for DCM and $\gamma_R = 1,35$ for DCH recommended by EC8)

A_s is the cross section area of the bar

$f_{ym} = 1,08 \cdot f_{yk}$ is the mean yielding stress of the steel of the bar

4.2.1.4 Any other data

Ductility

In the experimental investigation performed under cyclic loading, the attained ductility of the tested system (a panel connected with protruding bars to the supporting beam – see Figure 4.4) was more than five, as shown in Figure 4.6. However, for large displacements the bars suffered large plastic axial strains which led to their residual elongation and the permanent opening of the joint. For this reason, full contact of the panel with the beam could not be re-established during the reverse loading and the friction force at the joint could not develop. Due to this phenomenon, the horizontal force induced to the panel was sustained mainly by the “dowel action” of the connecting bars instead of the friction at the joint. As a result, slippage of the panel occurred, leading to considerable pinching. For these reasons, the connection itself shall not be designed for contributing to the ductile response of the panel, but shall be oversized as described in 4.2.1.2.

Dissipation

As shown in Figure 4.6, cyclic tests performed on the system of Figure 4.4 show an initial low dissipation capacity that increases with the horizontal displacement. In terms of specific energy dissipation (ratio to the correspondent perfect elastic-plastic cycle) a medium dissipation capacity is maintained through the cycles (up to 40%). At large displacements the behaviour is affected by the opening of the joint and the observed pinching.

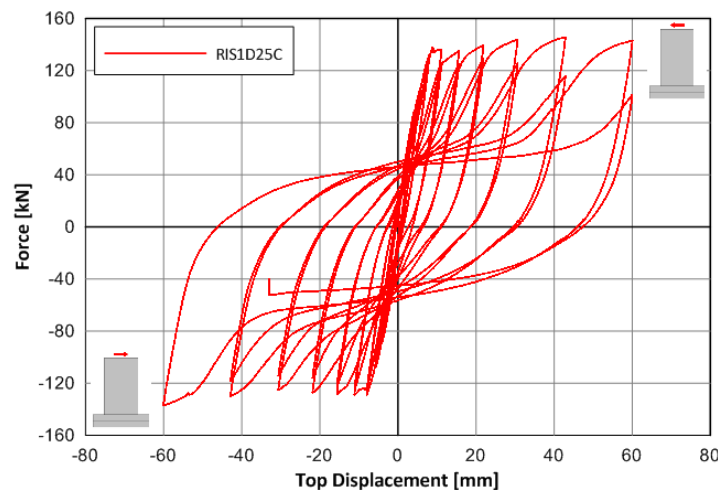

Figure 4.6

Deformation

The deformation capacity of the connection is governed by the elongation capacity, d_z , of the connecting bars in the vicinity of the joint. The effective length L_{eff} in which the bar elongation takes place extends in a distance of several bar diameters on both sides of the joint, where the bond capacity has reached its maximum value. From the evaluation of the experimental data, it was found that, at the yielding of the bars, L_{eff} was about 15 times the bar diameter.

Concerning the contribution of the joint opening to the drift capacity of the panel, it depends on the rotation θ at the base of the panel. This rotation can be approximated by (see Chapter 3 of *DGB*):

$$\theta = \frac{d_z}{0,75d}$$

where d is the distance of the connecting bars from the opposite edge of the panel.

Decay

Cyclic tests show that, at any displacement level, there is small strength decay in the second cycle compared with the strength of the first cycle.

Damage

For a practically elastic response of the connections, or even small excursions in the plastic zone, no evident damage was observed during the tests. For large displacements close to failure, spalling of the concrete occurred at the short sides of the panel while no damage was observed to the beam. It should be mentioned, however, that the damage related to the ultimate capacity of the connections depends on their strength.

4.2.2 Connections with wall shoes

4.2.2.1 General

There are several companies in the market that produce devices, usually called "wall shoes" and used to connect wall panels to beams or to other wall panels (Figure 4.7). A typical wall shoe is shown in Figure 4.8. It consists of:

- a steel nest with a strong bottom plate which is cast into the bottom part of the upper wall and fixed with anchor bars;
- an anchor bolt which is cast into the upper part of the lower wall or beam;
- a washer and a nut used to fasten the bolt to the bottom plate.

There are special requirements concerning:

- the minimum concrete cover;
- the minimum thickness of the wall cross section;
- the minimum distance from the wall edges;
- the principal and the supplementary reinforcement;

Which are usually specified by the producer. These requirements depend on the nominal force that each device can resist and vary from system to system.

Proper reinforcement shall be placed around the anchor bolts to confine the concrete around them and anchor them against pull-out.



Figure 4.7

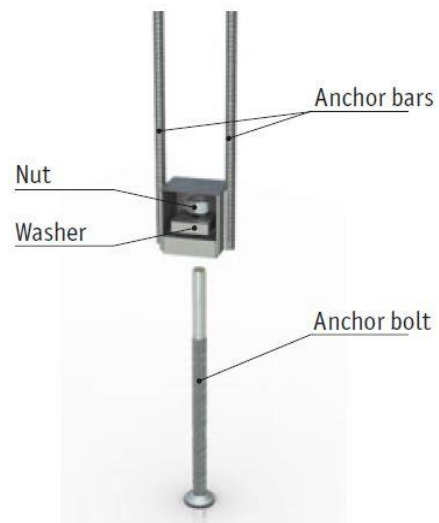

Figure 4.8

4.2.2.2 Strength

Figure 4.9 shows the resisting mechanism at the panel-to-beam connection under a seismic action that applies horizontal forces H to the panels at any floor of the structure. The connections provide the tensile strength in the tension zone, while the concrete provides the resistance in the compression zone.

No special measures are usually required to prevent sliding in the horizontal direction, since the horizontal resistance provided, mainly by the friction between the panel and the beam and secondarily by the dowel action of the bolts, is adequate to sustain the horizontal forces.

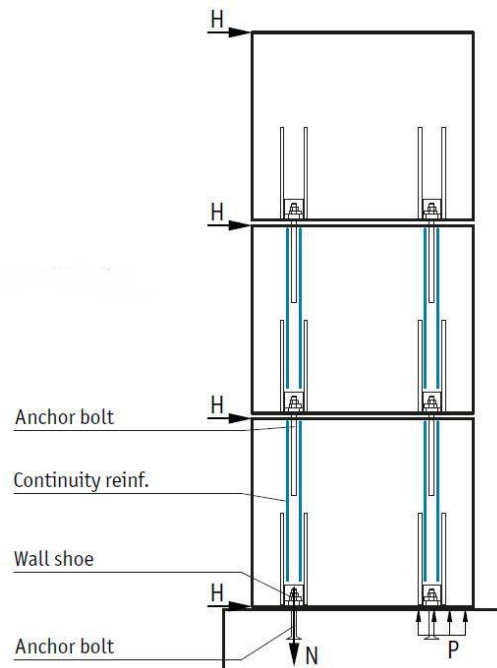

Figure 4.9

The possible failure modes associated with the resisting mechanism shown in Figure 4.9 are:

- pull-out of the anchor bolts;
- break of the anchor bolts;
- permanent elongation of the anchor bolts due to large strains developed;
- warping of the washer plate;
- failure of the concrete in the tension zone (not probable except in case of very high forces);
- sliding shear failure of the panel (not probable except in case of yielded anchor bolts).

The experimental investigation showed that permanent elongation of the anchor bolts occurs after their yielding with several unfavourable side effects, such as:

- the nuts stop being tightly fastened to the washer and as a result the connections turn loose;
- the nonlinear behaviour of the connections under cyclic loading is characterized by significant pinching.

To avoid such undesired situations, the connections shall be oversized in the sense of Clause 5.11.2.1.2 of *EC8*. Thus, the anchor bolts shall be verified for the axial forces induced to the connections under the design earthquake assuming an elastic response (behaviour factor $q=1,5$). Guidelines for the calculation of the forces that develop in the connections are given in *DGB*.

In general, all parts of the wall shoes, except the anchor bolt, should be over-proportioned, since only the anchor bolt is allowed to yield. Analytical calculations in support of this capacity design are very difficult to be performed even if sophisticated finite element models are used, and also might be of questionable accuracy due to the complicated stress situation that develops in the connecting mechanism. For this reason, only wall shoe systems that have been experimentally qualified shall be used.

4.2.2.3 Verifications

For industrially manufactured wall shoes the verification consists mainly on the axial yielding of the anchor bolt and the failure of the concrete in the compression zone. Details about the connection capacity and the additional measures necessary to ensure its integrity can be found in the product technical specification.

Verification against axial yielding of the anchor bolt

The following inequality shall hold:

$$N_d \leq N_{Rd}$$

where

N_d is the axial force induced to the anchor bolt, calculated from a structural analysis performed with behaviour factor $q = 1,5$

N_{Rd} is the design axial resistance of the anchor bolt according to the specifications provided by the producer.

Verification against failure of the concrete in the compression zone

The verification against failure of the concrete in the compression zone shall be performed in accordance with clause 6.1 of *EC2* on the basis of the moment that develops at the beam-panel joint under the design seismic loads. The joint moments are

given as an output of the analysis if the panel model described in Chapter 4 of *DGB* is used.

Other failure modes

The verification against breakage of the anchor bolts, permanent elongation of the anchor bolts, warping of the washer plate and sliding shear failure of the panel does not seem necessary, because it is improbable that these failure modes can occur, since the connections are oversized in accordance with the capacity design rule.

4.2.2.4 Any other data

Ductility

In the experimental investigation performed under cyclic loading, the attained ductility of the system (the wall panel connected to the supporting beam) was about 2,5, as shown in Figure 4.10. However, for large displacements the bolts suffered large plastic axial strains which led to their residual elongation and the loosening of the nuts leading to significant pinching, while small slip of the panel also occurred. For this reason, the connection itself shall not be designed for contributing to the ductile response of the panel but shall be oversized as described in 4.2.2.2.

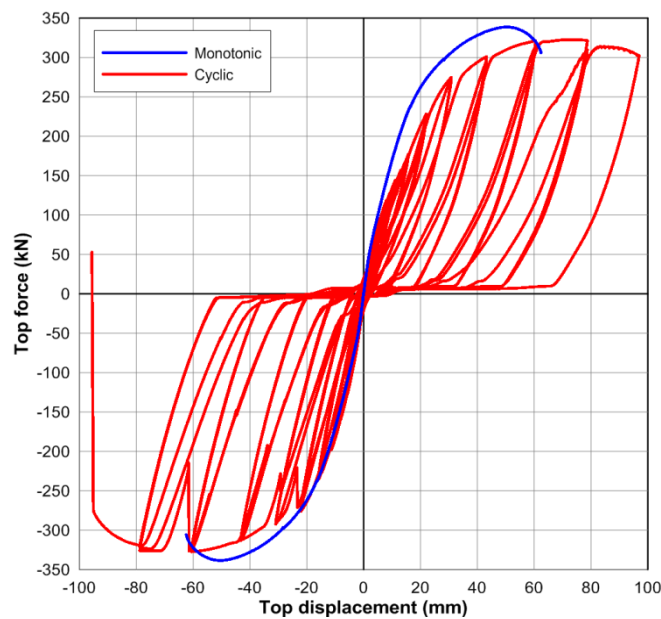

Figure 4.10

Dissipation

As shown in Figure 4.10, cyclic tests performed on the system show an initial low dissipation capacity that increases with the horizontal displacement. In terms of specific dissipation (ratio to the correspondent perfect elastic-plastic cycle) a very low dissipation capacity is maintained through the cycles (less than 10%). At large displacements, the behaviour is affected by the opening of the joint, the loosening of the bolts and the observed pinching.

Deformation

The deformation capacity of the connection is governed by the elongation capacity d_z of the anchor bolts. The effective length L_{eff} in which the bolt elongation takes place is equal to the sum of the thickness of the bottom plate of the shoe, the thickness of the

washer and the length along the cast part of the bolt (beam side), where the bond capacity has reached its maximum value. From the evaluation of the experimental data, it was found that, at the yielding of the bolts, L_{eff} was about 15 times the bolt diameter; however, due to the limited number of experiments, this value needs to be verified by additional experimental and analytical investigation.

Concerning the contribution of the joint opening to the drift capacity of the panel, it depends on the rotation θ at the base of the panel. This rotation can be approximated by (see Chapter 3 of *DGB*):

$$\theta = \frac{d_z}{0,75d}$$

where d is the distance of the anchoring bolt from the opposite edge of the panel.

Decay

Cyclic tests show that, at any displacement level, there is very small strength decay in the second cycle compared with the strength of the first cycle.

Damage

For practically elastic response of the connections, or even small excursions in the plastic zone, no evident damage was observed during the tests. For large displacements close to failure of the bolts, cracks occurred in the panel, especially in the vicinity of the bolted shoes. It is noted, however, that the damage related to the ultimate capacity of the connections depends on the strength of the connections.

4.2.3 Connections with bolted plates

4.2.3.1 General

This type of connections can be executed using steel plates that are connected to waiting nests fixed to the supporting beam and to the panel by an adequate number of bolts. The steel nests are embedded in the concrete and welded to reinforcing rebars so that the connection forces are gradually transferred to the concrete. A typical configuration of this connection is shown in Figure 4.11.

There are special requirements concerning:

- the minimum concrete cover;
- the minimum thickness of the wall's cross section;
- the minimum distance from the wall edges;
- the principal and the supplementary reinforcement

which depend on the nominal force that each device can resist and aim at preventing local damage to the concrete.

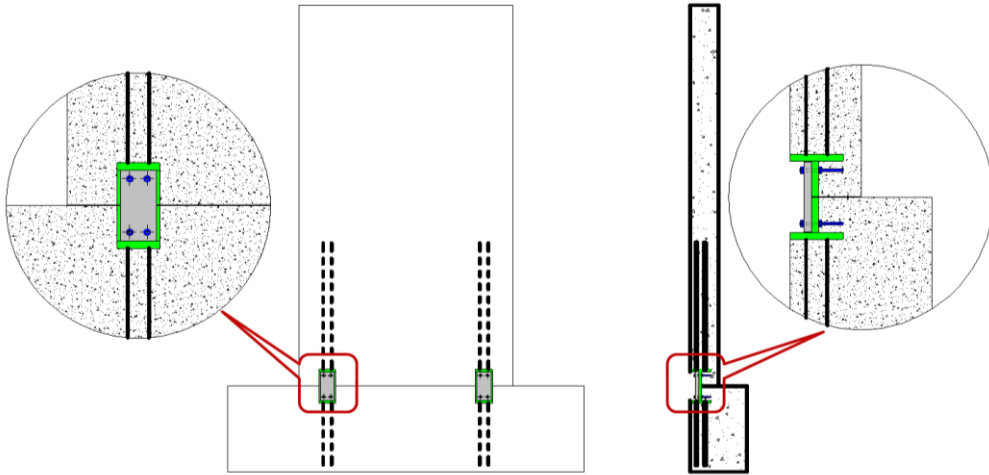

Figure 4.11

Yielding of the steel plate is not expected and the critical failure mechanism is the shear failure of the bolts, which must be avoided.

The advantage of this connection is that the steel plate can be easily substituted in case of damage. It is also noted that this connection does not pose any difficulties in the installation of the panels.

4.2.3.2 Strength

Figure 4.12 shows the resisting mechanism at the panel-to-beam joint under a seismic action that applies a shear force V to the panel. The figure shows only the height of the panel up to the zero-moment point (shear length, l_s), which is equal to one half of the total height the case of Figure 4.1 and equal to the full height in the case of Figure 4.2.

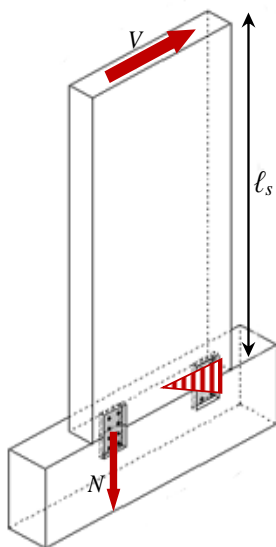

Figure 4.12



Figure 4.13

The connecting mechanism provides the tensile strength in the tension zone, while the concrete provides the resistance in the compression zone (Figure 4.12). No special measures are required to prevent sliding in the horizontal direction, since the horizontal

resistance provided by the friction between the panel and the beam and by the shear resistance of the connection is adequate to sustain the horizontal forces.

The possible failure modes associated with the resisting mechanism shown in Figure 4.12 are:

- Shear failure of the connecting bolts;
- Permanent distortion of the bolts and/or the plate due to large strains developed;
- Loosening of the connection due to the permanent distortion of the bolt holes;
- Failure of the connecting plate;
- Failure of the concrete in the compression zone;
- Sliding shear failure of the panel.

The experimental investigation showed that permanent out-of-plane bending of the steel plate and widening of the bolt holes occur for strong excitations (Figure 4.13) resulting in the loosening of the connection, while the nonlinear behaviour of the connections under cyclic loading is characterized by significant pinching. In addition, it is noted that shear failure of the bolts leads to brittle failure of the connection.

To avoid such undesired situations, the connections shall be overdesigned in the sense of clause 5.11.2.1.2 of *EC8*. Thus, the design action-effects of the connections shall be derived on the basis of the capacity design rules. Since the application of capacity design criteria to dual wall-frame integrated systems is, in general, difficult, it is suggested that the over-proportioning of the connections shall be made referring to the forces from a structural analysis performed with behaviour factor $q=1,5$. Guidelines for the calculation of the forces that develop in the connections are given in *DGB*.

4.2.3.3 Verifications

Verification against bolt shear failure

To avoid shear failure of the bolts, the following inequality shall hold:

$$N_d \leq N_{Rd}$$

where

N_d is the axial force induced to the connection, calculated from a structural analysis performed with behaviour factor $q = 1,5$

V_{Rd} is the shear resistance of the connecting bolts calculated by:

$$V_{Rd} = n A_s \alpha_v \frac{f_{ub} / \gamma_{M2}}{\gamma_{Rd}}$$

in which

n is the number of bolts on each connected element

A_s is the stress area of each bolt when the shear plane passes through the threaded portion of the bolt

α_v is a constant depending on the bolt class and the location of the shear plane

f_{ub} is the nominal ultimate tensile strength of the bolts

γ_{M2} is the material safety factor for the verification of bolts ($\gamma_{M2}=1,25$ according to *PT8*)

γ_{Rd} is a general safety factor which also accounts for the reduction of the shear strength of the bolts due to the simultaneous development of tensile stresses

caused by the out-of-plane distortion of the plate (Figure 4.13). Since these tensile stresses cannot be calculated within a typical design procedure, and it is desirable to design the connection away from the shear failure of the bolts, a value of $\gamma_{Rd} = 1.20$ is recommended.

Verification against failure of the connecting plate

To avoid failure of the connecting plate, the following inequality shall hold:

$$N_d \leq \min\{N_{pl,Rd}, N_{u,Rd}\}$$

where

N_d is the axial force induced in the connection, calculated from a structural analysis performed with behaviour factor $q=1,5$

$N_{pl,Rd}$ is the plastic resistance of the gross cross-section calculated by:

$$N_{pl,Rd} = A \frac{f_y}{\gamma_{M0}}$$

$N_{u,Rd}$ is the ultimate resistance of the net cross-section calculated by:

$$N_{u,Rd} = 0,9 A_{net} \frac{f_u}{\gamma_{M2}}$$

In these relations:

A is the gross area of the plate

A_{net} is the net area of the plate at the position of the holes

f_y is the nominal yield stress of the steel of the plate

f_u is the nominal ultimate tensile strength of the plate

γ_{M0} is the material safety factor ($\gamma_{M0} = 1,00$ according to *PT8*)

γ_{M2} is the material safety factor ($\gamma_{M2} = 1,25$ according to *PT8*)

Verification against permanent distortion of the bolt holes

To avoid permanent distortion of the bolt holes, the following inequality shall hold:

$$N_d \leq \frac{nk_1 \alpha_b f_u dt}{\gamma_{M2}}$$

where

N_d is the axial force induced in the connection, calculated from a structural analysis performed with behaviour factor $q=1,5$

n is the number of bolts on each connected element

k_1, α_b are coefficients according to clause 3.6.1 of *PT8*

f_u is the nominal ultimate tensile strength of the plate

t is the thickness of the plate

γ_{M2} is the material safety factor ($\gamma_{M2} = 1,25$ according to *PT8*)

Verification against failure of the concrete in the compression zone

The verification against failure of the concrete in the compression zone shall be performed in accordance with clause 6.1 of *EC2* on the basis of the moment that

develops at the beam-panel joint under the design seismic loads. The joint moments are given as an output of the analysis if the panel model described in Chapter 4 of *DGB* is used.

Other failure modes

The verification against permanent distortion of the bolts and the plate and against sliding shear failure of the panel does not seem necessary, because it is improbable that these failure modes can occur, since the connections are oversized in accordance with the capacity design rule.

4.2.3.4 Any other data

Ductility

In the experimental investigation performed under cyclic loading, the system did not show any ductility, as shown in Figure 4.14. Brittle shear failure of the bolts occurred at large horizontal displacements, while the response up to that point was almost elastic. For large displacements, the bolt holes were distorted becoming oval and, as a result, significant pinching was observed. For these reasons, the connection itself shall be oversized as described in 4.2.3.2.

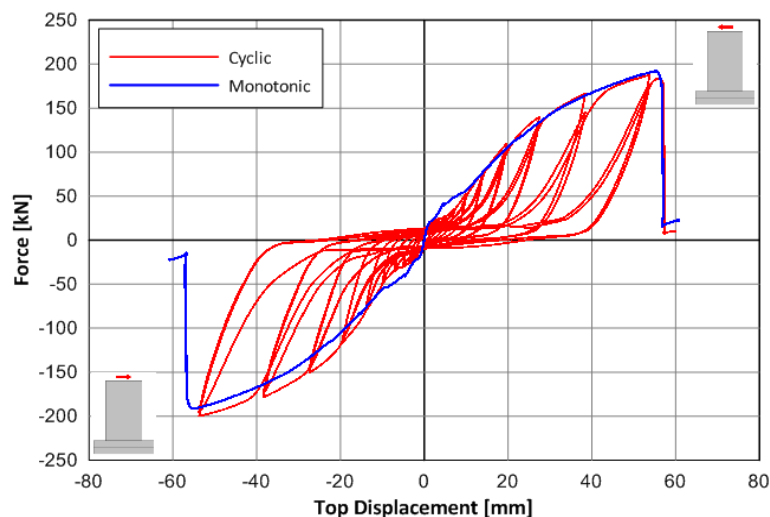

Figure 4.14

Dissipation

As shown in Figure 4.14, cyclic tests performed on the system of Figure 4.12 show very low dissipation capacity, even for large horizontal displacement. In terms of specific energy dissipation (ratio to the correspondent perfect elastic-plastic cycle) a small dissipation capacity is maintained through the cycles. At large displacements the behaviour is affected by the widening of the bolt holes and the observed pinching.

Deformation

The deformation capacity of the connection is governed by the overall elongation capacity d_z which is the cumulative sum of the elongation of the steel plate, the shear deformation of the bolts and the widening of the holes. The elongation d_z depends on the strength of the steel plate and the diameter and the strength of the bolts and it is not easy to calculate analytically.

Concerning the contribution of the joint opening to the drift capacity of the panel, it depends on the rotation θ at the base of the panel. This rotation can be approximated by (see Chapter 3 of DGB):

$$\theta = \frac{d_z}{0,75d}$$

where d is the distance of the centreline of the connection from the opposite edge of the panel.

Decay

Cyclic tests show that, at any displacement level, there is very small strength decay in the second cycle compared with the strength of the first cycle.

Damage

For the response of the system up to imposed forces considerably lower than the capacity of the connections, no significant damage was observed during the tests. For large displacements close to failure of the connections, spalling of the concrete occurred close to the connections and minor cracks occurred in the body of the panel. Also, out-of-plane bending of the steel plates was observed. It is noted, however, that the damage related to the ultimate capacity of the connections depends on the strength of the connections.

4.3.2 Shear keys

Shear keys couple the horizontal in-plane displacements of panel and structure, providing a contemporary panel out-of-plane displacement restraint. For vertical panels they should allow the vertical displacements related to thermal expansion and other geometrical effects. The efficiency of the sliding mechanism shall be experimentally verified through monotonic and cyclic tests, in accordance with clause 4.2.

Figure 4.15 shows a type of shear key made by a steel element welded to a steel plate embedded in the beam or column and connected with the anchor channel cast into the panel through a bolted connection.

For the bearing capacity of the device reference should be made to the technical specifications of the producer that are usually based on experimental testing. The out-of-plane resistance verification of the connection is made with reference to the transverse force calculated with *EC8* rules on the basis of the mass of the panel.

The shear keys have to satisfy the vertical displacement and rotation demand and to withstand the design load combination (comprising in-plane and out-of-plane actions) and also additional forces related to friction.

An initial type testing shall be performed submitting the device to monotonic and cyclic longitudinal actions for different values of the transverse force (3D effects) consistently with the joint arrangement expected in the structure and with the geometrical allowances, considering also the production and installation tolerances. The proper functioning shall be checked all over the range of the expected vertical displacements and rotations.

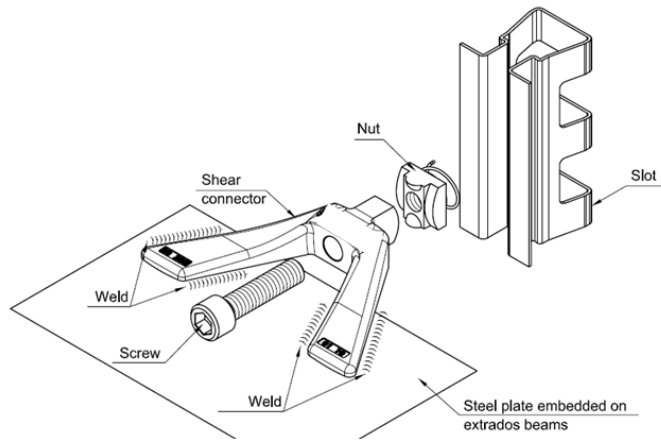

Figure 4.15

5. DISSIPATIVE SYSTEMS

Between the two extreme solutions of isostatic systems, with their large displacement demand, and integrated systems, with their high force demand, the dissipative systems of cladding connections offer an intermediate solution able to keep displacements and forces within lower predetermined limits.

5.1 Structural arrangements

In this document three structural arrangements are considered, one for vertical panels and two for horizontal panels. For vertical panels, starting from the isostatic pendulum system of fastenings of Figure 3.1a, a number of dissipative mutual connectors are added between the panels, opposing the relative slide at their vertical joints. Figure 5.1 shows this solution. The corresponding arrangement matrix is given in Table 5.1. An equivalent solution can be obtained starting from the isostatic rocking system of Figure 3.1c.

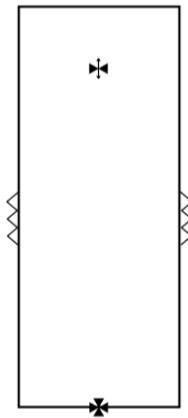

Figure 5.1

	A	B	C	D	E	F
x	f	/	F	/	d	d
y	f	/	F	/	f	f
z	f	/	S	/	d	d

Table 5.1

For horizontal panels, starting from the isostatic hanging system of fastenings of Figure 3.2a, a number of dissipative mutual connectors are added between the panels, opposing the relative slide at their joints. An equivalent solution can be obtained starting from the isostatic seated system of Figure 3.2b that can be also used in combination with the former one for the different panels. Figure 5.2 shows this solution with some adaptations. The corresponding arrangement matrix is given in Table 5.2.

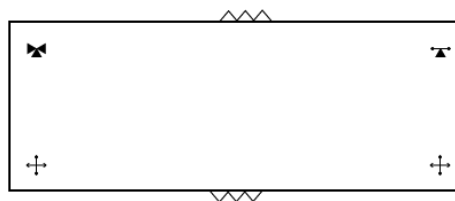

Figure 5.2

	A	B	C	D	E	F
x	s	s	f	s	d	d
y	f	f	f	f	f	f
z	s	s	f	f	d	d

Table 5.2

The last solution consists of a hanging (or seated) system where two lower corner supports along x are added to the panel with dissipative folded plates attached to the columns. No mutual connectors are placed in this case in the joint between the adjacent panels as shown in Figure 5.3. The corresponding arrangement matrix is given in Table 5.3.



Figure 5.3

	A	B	C	D	E	F
x	d	d	f	s	0	0
y	f	f	f	f	0	0
z	s	s	f	f	0	0

Table 5.3

5.2 Friction devices

The friction devices considered in this document are made of two steel T shape parts that are fixed with a symmetrical set of bolted fasteners to the adjacent panels in special recesses and coupled with two lateral bolted steel plates, as shown in Figure 5.4. The length of the slotted holes made in the web of the T shape profiles gives the limit to the reciprocal slide between the parts. The tightening torque given to the bolts, controlled by dynamometric wrench, activates the friction between the plates determining the slip shear force. Two brass sheets are interposed between the steel plates and the profiles to ensure the stability of the repeated slide cycles. A centred limited longitudinal shear is transmitted through this device.

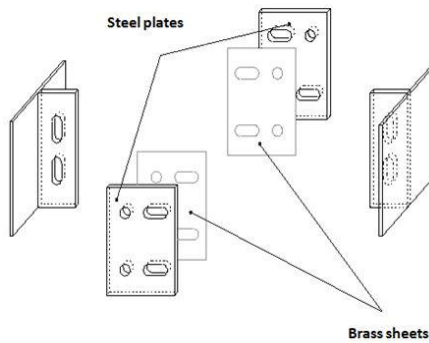

Figure 5.4

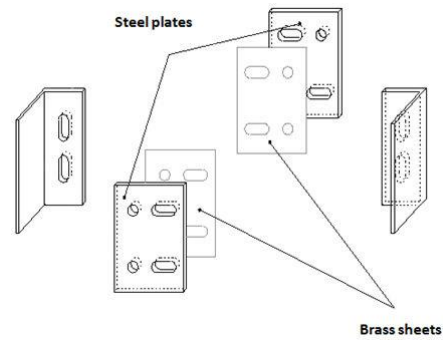

Figure 5.5

The installation of the device described above requires the access from both the side of the panel. If the access is possible only from one side, the two T shape profiles are replaced by as many L shape profiles as shown in Figure 5.5. In this case the transmission of the longitudinal shear gives also, on the set of the anchoring fasteners, a torsion that increases significantly the resultant forces in the single fasteners.

In a set of several panels the chain of production and positioning tolerances can lead to relevant linear and angular deviations between the adjacent parts of the connection. This requires a three-dimensional system of slotted holes of adequate length to match the bolts with the corresponding threaded bushes inserted in the panels.

If normal bolted jointing is applied, the settlements of the bolts in the slotted holes allowances under alternate loading lead to force-displacement cycles with very high pinching. To avoid this harmful pinching effect the fully friction jointing with pre-tightened bolts shall be adopted. This requires that all the components of the connection are not galvanised and that special Belleville elastic cup washers are used.

The alternative solution of welded joint overcomes the problems of tolerances simply welding in site the T or L shape profiles to the counter plates of the panels after their installation, adjusting previously the correct assemblage of the connection components. With the welded solution the disassemblage easiness of the connection is lost.

In any case the installation of the dissipative connections and their effective functioning require a precise execution of the panel wall with tighten tolerances.

5.2.1 Properties

The main properties of the friction devices of concern are:

- very large energy dissipation capacity due to the rectangular hysteretic shape of cyclic response;
- the brass interposed sheets are necessary to ensure stability to the subsequent friction cycles;
- a loss of pre-tightening force up to 67% is expected after few cycles due to the surface abrasion;
- the use of Belleville elastic cup washers reduces the loss of pre-tightening force down to 33%;
- as from international literature the friction factor is $\mu=0,44$ in dynamic, $\mu=0,50$ in static condition;
- due to the natural behaviour variability peaks up to 1,40 can be expected with respect to friction law;

- sandblasting surface treatment can increase the friction factor only for very few cycles;
- after a strong friction engagement the bolts shall be released for re-centring of the structure and re-tightened;
- the same steel plates and brass sheets can be re-used with the same behaviour of the new ones.

The displacement capacity δ_{max} of the device is related to the length l_s of the slotted hole with $\delta_{max}=l_s-\phi$ where ϕ is the diameter of the bolt.

5.2.2 Design

The longitudinal shear force transmitted by this friction device can be computed with:

$$V_z = \frac{2Nn\mu k\psi\rho}{\gamma\sqrt{1+\frac{e^2}{d^2}}}$$

where:

- N is the tightening force in one bolt controlled by the dynamometric wrench ($N=5M/\phi$ with M measured tightening moment and ϕ bolt diameter);
- n is the number of friction surfaces ($n=2$ in the case of concern);
- μ is the friction factor;
- $k = 0,63$ for slotted holes (see PT8);
- ψ residual cyclic force factor =0,67 for Belleville washers (=0,33 for common washers);
- ρ peak factor;
- γ partial safety factor (γ_{M3} of PT8);
- e horizontal spacing of the bolts;
- d vertical spacing of the bolts.

	V_{minj}	
μ	0,44	0,51
ψ	0,67	1,00
ρ	1,00	1,40
γ	1,10	1,00

Table 5.4

The equation above can be used for the calculation of the minimum and maximum expected values of the longitudinal shear in the connection with the factors given in Table 5.4. The minimum value refers to the calculation of the cyclic resistance contribution to the overall structural system, the maximum value refers to the verification of the connection components. For a good behaviour of the dissipative device all its components shall remain in the elastic field.

For the correct functioning, the bolts shall be able to slide along the slots of the lateral profiles without seizures and this requires that the outer strip of the flange is stiff and

resistant enough to behave elastically in flexure under the horizontal component $H=Ve/(2d)$ of the transmitted force. For this purpose the thickness t of the flange shall be

$$t \geq \frac{0,75V_{\max} e l}{2 d b^2 f_{yd}}$$

with l length of the slotted hole, b width of the outer strip and f_{yd} design yield strength of the steel.

For the symmetric T shape profile fixed with 4 bolted fasteners to the panel (2 at each side), the three components Z vertical shear, X axial force and Y horizontal shear of the force in one fastener are:

$$Z \geq \frac{V_{\max}}{4} \qquad X \approx \frac{V_{\max} e_x}{d_z} \qquad Y = 0$$

where e_x is the distance of the mid-connection to the panel edge and d_z is the distance between the two superimposed fasteners. For the L shape profile fixed with 3 superimposed fasteners to the panel, the three components of the force in the upper and lower fasteners are

$$Z \geq \frac{V_{\max}}{3} \qquad X \approx \frac{V_{\max} e_x}{2,5 d_z} \qquad Y \approx \frac{V_{\max} e_y}{2,0 d_z}$$

where d_z is again the spacing between two adjacent fasteners and e_y is the transverse eccentricity of the fasteners with respect to the vertical central plane of the connection where the shear V_{max} is transmitted.

If the lateral profiles are fixed to the panels by welding, the proper calculation of stresses in the welding shall be performed taking into account the pertinent eccentricities.

5.2.3 Behaviour model

An example of cyclic behaviour of the friction devices is given in Figure 5.6 by the diagram of the shear V_z as a function of the slide d_z . Neglecting the small end inclination of the increasing branches, a constitutive bilinear force-displacement law can be assumed with a first elastic branch followed by a horizontal friction branch extended to the functional limit given by the length of the slotted holes (Figure 5.7). If the slope of the elastic branch is not determined, also a rigid-friction model can be assumed. These models can be used in the non-linear structural analysis. In x and y directions a fixed constraint can be assumed.

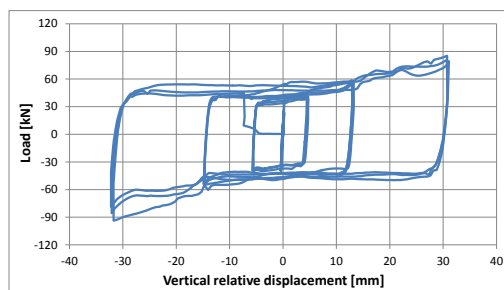

Figure 5.6

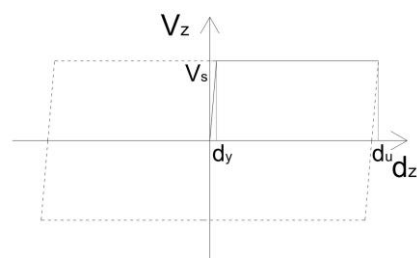

Figure 5.7

5.3 Multi-slit devices

The multi-slit devices considered in this document have a composition similar to the friction devices described in 5.2. The two lateral solid steel plates used in the latter devices are replaced by as many lateral plates, with slits of various shapes and sizes, fixed to the adjacent T shape or L shape profiles. The slits isolate a number of slender strips and in this way move the shear behaviour of the solid plates to a flexural diffused behaviour of the single strips which is suitable for energy dissipation. For the assembly of multi-slit devices on the work, the same problems of tolerances presented for the friction based devices have to be solved, with slotted holes, not galvanised components and special washers where bolting is used.

As shown in Figure 5.8a-b, one or two columns of straight strips can be adopted, expecting for them a beam behaviour with two end plastic hinges for large displacements, but also spindle-shape strips of Figure 5.8c can be used, able to enlarge the yielded zone over the hole length of the strips. The slenderness of the strips gives the overall shear deformation capacity to the plates and their number leads to the overall shear force capacity.

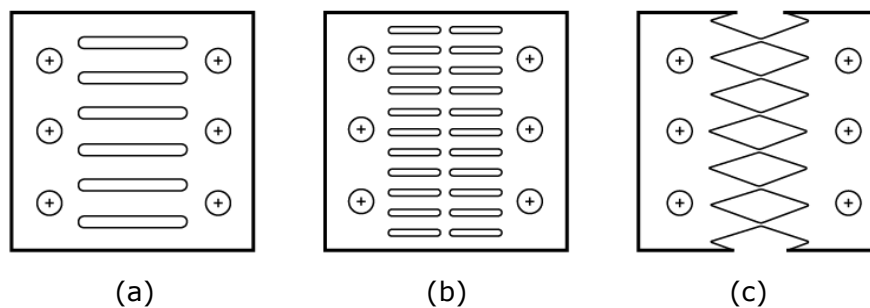

Figure 5.8

As shown by the experimental diagram of Figure 5.9, the main difference between friction and plastic dissipative devices is that the hysteretic force-displacement cycles develop along an almost constant force for the former, develop along an inclined line with increasing force for the latter. This increase for larger displacements is due to the combination of the over-strength of hardening steel, of the progressive development of the plastic moment in the rectangular section of the strips and of the second order geometrical effects at large deformations. The model should also reproduce the pinching of the diagrams around the zero slide (Figure 5.10).

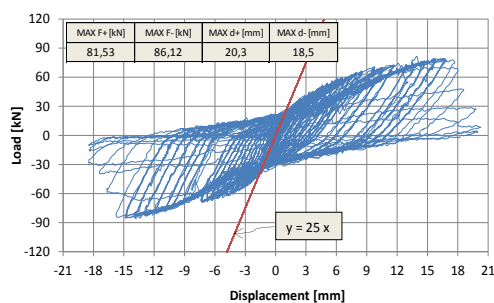

Figure 5.9

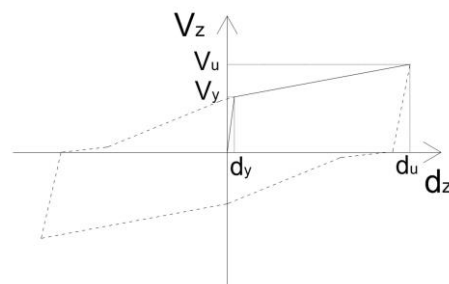

Figure 5.10

5.3.1 Properties

The main properties of the multi-slit devices of concern are:

- large energy dissipation capacity due to the hysteretic shape of the cyclic response;

- good stability of the cyclic response with limited irregularities;
- a minimum ductility is required for steel with (see EC3):
 - o over strength ratio $\frac{f_u}{f_y} \geq 1,10$
 - o elongation at failure $\geq 15\%$
- a sufficient thickness is required to avoid lateral buckling;
- after a strong plastic engagement the multi-slit plates shall be removed for the re-centring of the structure and replaced with new ones.

5.3.2 Design

The longitudinal shear force transmitted by any single multi-slit plate with n rows of strips can be computed, neglecting the shear deformation of the strips, both for rectangular and spindle shape strips, with the following equations.

$$V_z = \frac{nbh^2f_y}{3l} \quad \text{at the yielding limit:}$$

$$V_u = \varphi_{pl} \varphi_{os} \varphi_{sh} V_z \quad \text{at the ultimate limit}$$

where b is the thickness of the plate, h is the maximum depth of a strip, l is its length, f_y is the yielding stress of steel and

φ_{pl} is the plastic factor ($=1,5$ for rectangular sections);

φ_{os} is the over-strength factor ($\approx 1,5$ for ordinary steel);

φ_{sh} is the hardening shape factor ($\approx 0,94$ for ordinary steel).

5.3.3 Behaviour model

For the multi-slit devices a constitutive bilinear force-displacement law can be assumed with a first elastic branch followed by a branch with smaller inclination extended to the functional limit. The singular points "1" at the elastic limit and "2" at the functional limit of this bilinear diagram can be computed with:

$$d_{z1} = \frac{l^2 f_{yd}}{3E_s h} \quad \text{for rectangular strips}$$

$$d_{z1} = \frac{0,78l^2}{E_s h} \quad \text{for spindle shape strips}$$

$$V_{z1} = \frac{nbh^2 f_{yd}}{3l} \quad \text{for both rectangular and spindle shape strips}$$

$$d_{z2} = \frac{d_{z1} \varepsilon_u E_s}{f_{yd}} \quad \text{for both rectangular and spindle shape strips}$$

$$V_{z2} = \varphi_{pl} \varphi_{os} \varphi_{sh} V_{z1} \quad \text{for both rectangular and spindle shape strips}$$

where f_{yd} is design yield strength of the steel, E_s is its elastic modulus and ε_u the ultimate strain.

This model gives the relation between the longitudinal shear force V_z and the corresponding deformation d_z and can be used in the non-linear structural analysis. In x and y directions a fixed constraint can be assumed.

5.4 Steel cushions

The steel cushions considered in this document are made of a flattened ring-shape plate that is fixed with central fasteners to the adjacent panels in special recesses as shown in Figure 5.11a. They can be utilized wherever multi-slit and friction devices are used. They can transmit longitudinal shear forces V_z when they are used between the panels. After significant plastic deformations, the steel cushions shall be removed for re-centring the structure and replaced with new ones.

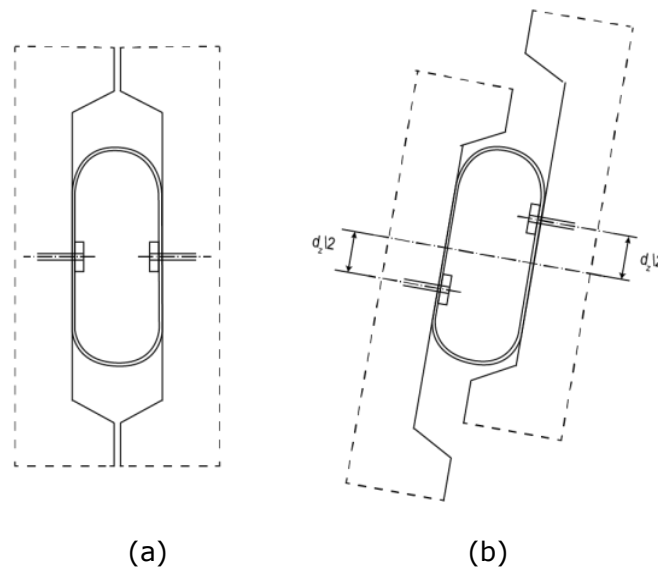

Figure 5.11

The semi-length of the straight sides of the cushions provides the limit to the reciprocal slide between the connected panels. During the sliding (or rolling) movement (see Figure 5.11b) the plate undergoes large flexural plastic deformations that lead to energy dissipation. Instead of full cushions, half-cushions could also be used, made of U-shape plates with similar deformation behaviour. The U-shaped connectors are used specifically for shear whereas the steel cushions presented here are able to bear shear and axial loads combined together.

5.4.1 Properties

The main properties of the steel cushions are:

- very large energy dissipation capacity due to the rectangular hysteretic shape of cyclic response,
- symmetric and stable hysteretic response throughout subsequent cycles,

Regarding the material properties, a minimum ductility is required for steel material as per EC3:

- over strength ratio of $\frac{f_u}{f_y} \geq 1,10$
- elongation at failure $\geq 15\%$

Stainless steel material may also be used instead of normal steel for purposes of corrosion protection. If this is the case, then the ultimate strain may be assumed as $25\varepsilon_y$.

5.4.2 Design

With reference to Figure 5.12 where the position of the plastic hinges is shown, the ultimate longitudinal shear force transmitted by the steel cushion can be computed with:

$$\gamma V_z = P_u = \frac{4M_u}{\bar{D}} \quad \bar{D} = 2r \cos \varphi$$

$$M_u = \frac{f_{yd} b t^2}{4}$$

$$P_u = \frac{f_{yd} b t^2}{\bar{D}}$$

$$f_{yd} = \frac{f_{sy}}{\gamma}$$

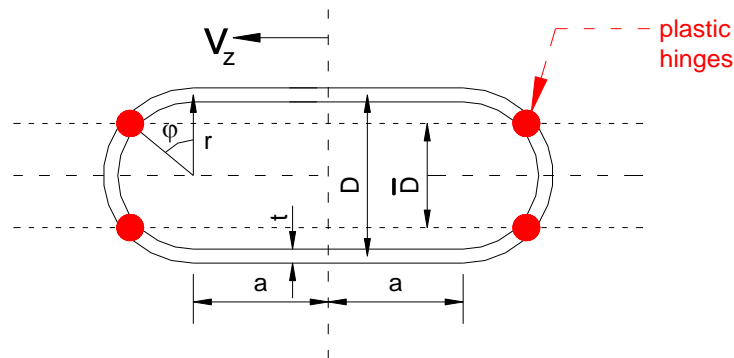

Figure 5.12

5.4.3 Behaviour model

An elastic-perfectly-plastic hysteretic constitutive curve is suggested to represent the nonlinear response of the cushions. The post-yield hardening ratio is neglected since it presented negligible values during the experiments as shown in Figure 5.13. The elastic-perfectly-plastic constitutive curve alters as the axial load on the cushions changes. The variation is shown in Figure 5.14. The constitutive curve presented in Figure 5.14 provides the relation between the longitudinal shear force V_z and the corresponding deformation δ_z and can be used in the non-linear structural analysis. The point "A" in Figure 5.14 is calculated by using δ_h and P_u values as given below. During the "rolling" action of the cushion, in every displacement step a different section comes to the point of maximum moments and yields, thus as opposed to conventional understanding, the yielded sections do not reach ultimate displacement capacity as long as the geometrical conditions are satisfied (i.e. the cushion elongates a lot to hit the heads of the bolts and rupture).

The ultimate strength of the cushion is a function of the location of the maximum moment. The angle φ_{\max} that indicates this location can be computed by

$$\frac{dM(\varphi)}{d\varphi} = 0$$

The resulting formulae are given in Table 5.5. After determining the ϕ_{\max} , the strength can be computed by the formula given in section 5.4.2.

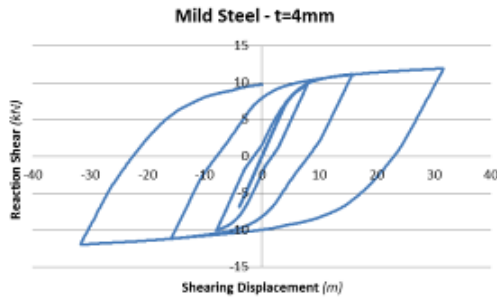

Figure 5.13

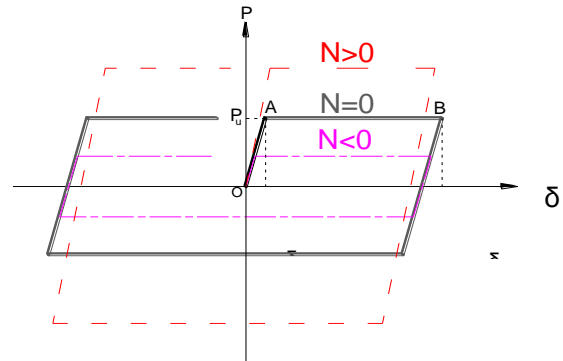

Figure 5.14

Once the shear strength and the displacement are calculated, the yield displacement can be computed by the following relation.

$$\delta_h = \frac{V r^3}{4EI} \left(\frac{2\pi^2 a^2 + 8\pi ar + (3\pi^2 - 16) r^2}{2\pi a^2 + 8ar + \pi r^2} \right)$$

The displacement occurs under the effect of the P_u corresponding to the yield displacement δ_y . Therefore P_u and δ_y will be used to find the initial stiffness K_0 of the cushion:

$$K_0 = \frac{P_u}{\delta_h} = \frac{\frac{f_{yd} b t^2}{D}}{\frac{V r^3}{4EI} \left(\frac{2\pi^2 a^2 + 8\pi ar + (3\pi^2 - 16) r^2}{2\pi a^2 + 8ar + \pi r^2} \right)}$$

The Ultimate displacement capacity of the cushion is a function of the length of the straight part, $2a$. The ultimate displacement capacity of the cushion is thus equal to $2a$. The displacement ductility of the cushion μ_{ult} depends solely on the length of the straight part of the cushions and the yield displacement.

$$\mu_{ult} = \frac{2a}{\delta_y}$$

Table 5.5. Pure Longitudinal Loading

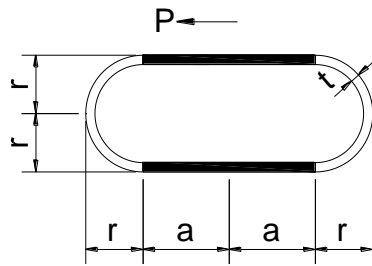

Work of axial deformations will be neglected

Straight parts have infinitely large bending stiffness

Moment

$$M(\varphi) = \frac{Pr}{2}(1 - \cos\varphi) + \frac{a + r \sin\varphi}{r + a} \left[-\frac{Pr(a + r)(\pi a + 2r)}{2\pi a^2 + 8ar + \pi r^2} \right]$$

$$M_{\max} = M(\varphi_{\max})$$

Location of Max. Moment

$$\varphi_{\max} = -\frac{\log \left(\frac{\frac{3i\pi r^3}{2} + 12iar^2 - 3a^2r + 2ia^3 - 6r^3 - 3\pi ar^2 + 3i\pi a^2r}{\frac{3i\pi r^3}{2} + 12iar^2 + 3a^2r + 2ia^3 + 6r^3 + 3\pi ar^2 + 3i\pi a^2r} \right)}{2} i$$

Longitudinal Displacement

$$\delta_h = \frac{Pr^3}{4K_0} \left(\frac{2\pi^2 a^2 + 8\pi ar + (3\pi^2 - 16)r^2}{2\pi a^2 + 8ar + \pi r^2} \right)$$

5.4.4 Other aspects

Steel cushions can be placed not only in between the adjacent panels but also both at the bottom and on top of the panels, as shown in Figure 5.15. When necessary the bottom cushions can have an elastomer infill as shown in Figure 5.16.

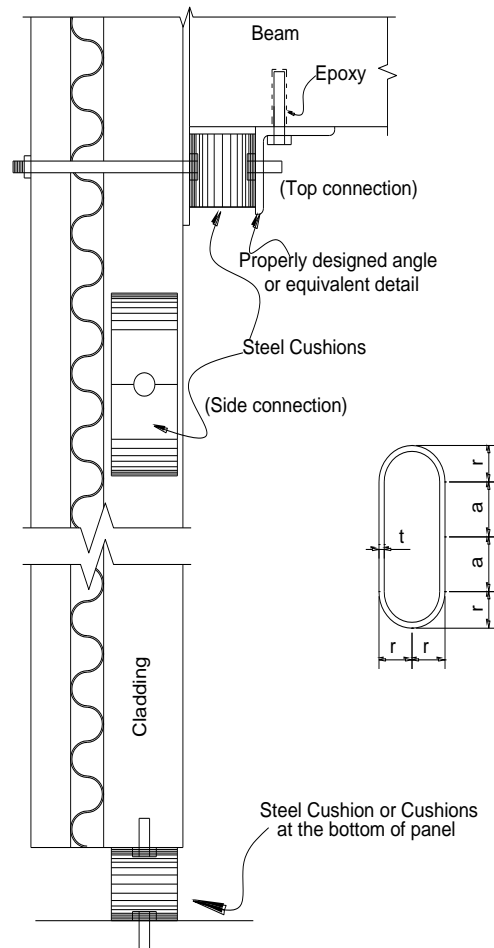

Figure 5.15

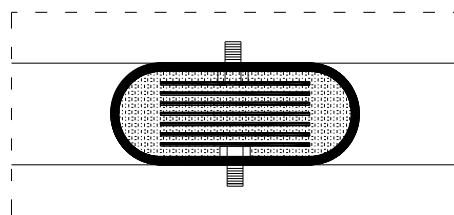

Figure 5.16

In these cases the function of the steel cushions is quite different. When between the panels, they are added to an isostatic arrangement that has its stability ensured by other connections. The inter-panels cushions can be proportioned in strength with reference only to the desired level of stiffening and dissipation to be introduced in the structure. When at the base and at the top, the cushions are indispensable for the stability of the panels and shall be first proportioned in strength with reference to the actions calculated by the structural analysis.

Figure 5.17 shows these solutions, (b) with single or (a) with double base supports. The conditions for the alternative or combined use of the different locations were discussed below.

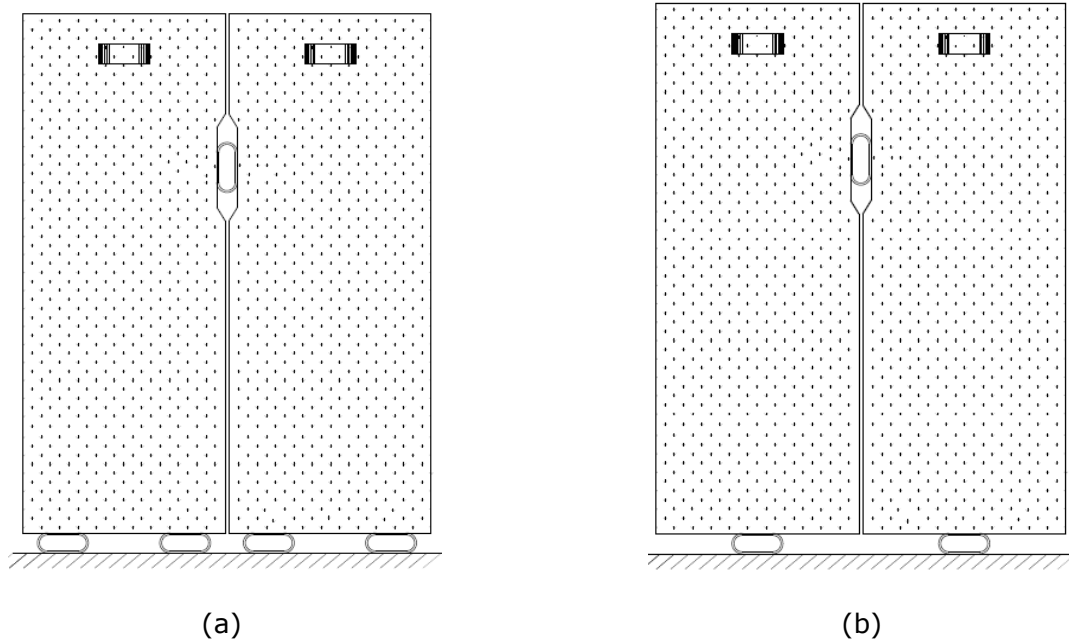
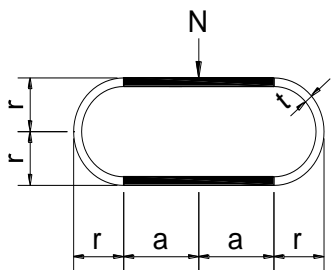

Figure 5.17

By choosing a proper stiffness and energy dissipating capacities for the cushions in three different locations, the following boundary conditions can be achieved:

- two cushions at the bottom with relatively high rigidity and a flexible cushion on top will produce results closer to the results of integrated panels with relatively smaller force demand
- relatively small rigidity for three cushions gives results closer to isolated solution with lower displacement demand, while the same results will be expected by the first alternative mentioned above with very flexible cushion on top.
- the cushion used on top of the panel will be acting always as a strengthening elements to resist the out-of-plane movement of the cladding without causing any impact on the structure.
- the panels can be connected in different ways depending on the design goals, such as designing weak cushions to resemble isolated-like panels and strong cushions to resemble panels that behave closer to the fixed panel case
- the cushions between adjacent panels can be more than one
- the diaphragms should preferably behave rigid in order to utilize effectively the available stiffness of the claddings.

Table 5.6. Pure Vertical Loading

		<p>$N > 0$ Compressive Force $N < 0$ Tensile Force</p>
Work of axial deformations will be neglected		
Straight parts have infinitely large bending stiffness		
Moment	$M(\varphi) = \frac{Nr}{2} \left(\frac{2}{\pi} - \sin\varphi \right)$ $M_{\max} = M(\varphi_{\max})$	
Location of Max. Moment	$\varphi_{\max} = \frac{\pi}{2}$	
Vertical Displacement	$\delta_v = \frac{(\pi^2 - 8)Nr^3}{4\pi K_0} \approx \frac{0,15Nr^3}{K_0}$	

In general situation, system will undergo horizontal and vertical loadings. Vertical load will cause a decreasing in radius as much as the half of the vertical displacement. It should be noted that compression forces will cause the geometry of the cushion to change, however the formulae presented here are valid as long as the altered geometrical values are inserted in:

$$\delta_v = \frac{(\pi^2 - 8)Nr^3}{2\pi EI} \approx \frac{0,3Nr^3}{EI}$$

where EI denotes the initial rigidity of steel. The new radius of the cushion is $\bar{D} = D \pm \delta_v$ (+ is for tensile forces, - is for compressive forces). Once the \bar{D} is defined, the same procedure mentioned above can be utilized here again.

Table 5.7. Horizontal and Vertical Load Combination

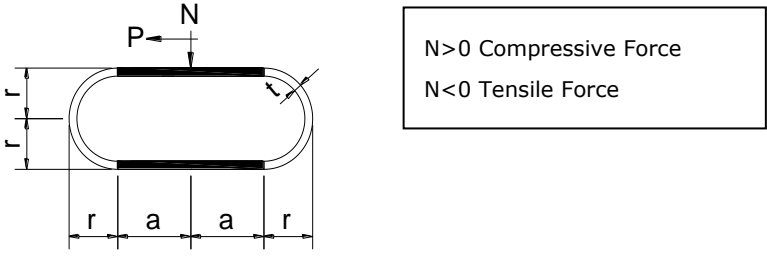
	
Work of axial deformations will be neglected	
Straight parts have infinitely large bending stiffness	
Moment (left hand side)	$M(\varphi) = \frac{Nr}{2} \left(\frac{2}{\pi} - \sin\varphi \right) - Pr \left(\frac{\cos\varphi - 1}{2} - \frac{(2r + \pi a)(a + r \sin\varphi)}{2\pi a^2 + 8ar + \pi r^2} \right)$ $M_{\max} = M(\varphi_{\max})$
Moment (right hand side)	$M(\varphi) = \frac{Nr}{2} \left(\frac{2}{\pi} - \sin\varphi \right) + Pr \left(\frac{\cos\varphi - 1}{2} - \frac{(2r + \pi a)(a + r \sin\varphi)}{2\pi a^2 + 8ar + \pi r^2} \right)$ $M_{\max} = M(\varphi_{\max})$
Location of Max. Moment (φ_{\max})	$\varphi_{\max} = \frac{dM(\varphi)}{d\varphi} = 0$
Horizontal Displacement	$\delta_h = \frac{Pr^3}{4K_0} \left(\frac{2\pi^2 a^2 + 8\pi ar + (3\pi^2 - 16)r^2}{2\pi a^2 + 8ar + \pi r^2} \right)$
Vertical Displacement	$\delta_v = \frac{(\pi^2 - 8)Nr^3}{4\pi K_0} \approx \frac{0,15Nr^3}{K_0}$

5.5 Folded steel plates

Figure 5.20 shows the use of folded steel plates for the connection of horizontal panels to the adjacent columns. Any panel is seated on a couple of steel brackets (see Clause 4.3.1) that ensure a prompt vertical support independently from the other panels. Four folded steel plates are then fixed at the corners providing full translational restrains in all x, y, z directions for a hyperstatic overall arrangement. In the two in-plane x and out-of-plane y directions the folded plates have the elastoplastic behaviour described hereunder. In the vertical z direction they can add a fixed bilateral restraint or leave a displacement freedom depending on the type of fastening on then column. The elastic deformability in x direction can attenuate the effects of thermal expansion.

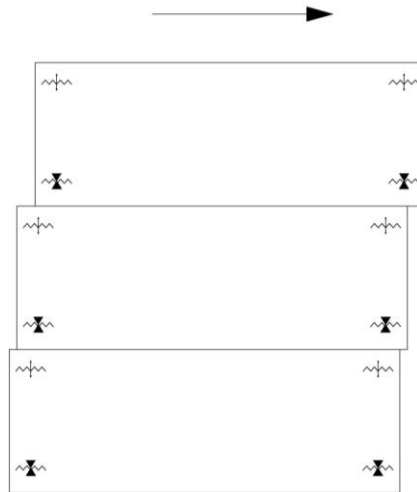

Figure 5.20

The Figure 5.21a shows the details of a folded steel plate. The two lateral parts are attached one to the column and one to the panel. They are bolted to pre-installed fasteners through slotted holes that can adjust the execution tolerance. Additional wrought plates provides the due tangent restraint after the tightening of the bolts. Of the two intermediate sides, the shorter one is placed in x direction (parallel to the panel), the longer one is placed in y direction (orthogonal to the panel).

Steel folded plates should be proportioned to keep an elastic flexural behaviour in x, y directions up to the serviceability limit state (with small deformations) and to display plastic deformations beyond this limit, with residual deformations (also out-of-plane) after the earthquake and need of their replacement and adjustment of the panel arrangement.

To permit a symmetric $\pm a$ maximum displacement in x direction, the two intermediate sides of the folded plate shall be related by $b=1,5a$. The amplitude a shall be related to the expected deformation of the columns under earthquake condition taking into consideration the contribution of the steel folded plates to the seismic response of the structure. The maximum value of this contribution can be evaluated on the basis of the design plastic moment of the plate and the corresponding longitudinal force

$$M_{pd} = \frac{f_{yd}Lt^2}{4} \quad F_x = \frac{2M_{pd}}{b}$$

while the maximum out-of-plane force is

$$F_x = \frac{2M_{pd}}{a}$$

where t is the thickness and L is the width of the plate and f_{yd} is its design strength.

The steel folded plates are always mounted in couple, in a symmetric arrangement at the two ends of the panel. The resistance of the couple is slightly influenced by the panel out-of-plane displacement degree of freedom, which may be restrained by other panel connections. In any case, the global behaviour of the couple (Figure 5.21b) can be modelled with good approximation for the structural analysis through an elastic-plateau load-displacement relationship with classical kinematic hardening hysteretic law, neglecting on the safe side the slight over-resisting tendency that occurs for very large displacements due to the influence of axial stiffness for second order effects. The elastic stiffness and the resistance may be determined by experimental testing and/or numerical modelling. The behaviour of the single device is more influenced by the panel out-of-plane displacement degree of freedom, and in particular it is almost symmetric for non-restrained condition (Figure 5.21c) and largely asymmetric for restrained condition

(Figure 5.21d). This shall be taken into account when designing the post-installed fastener connections.

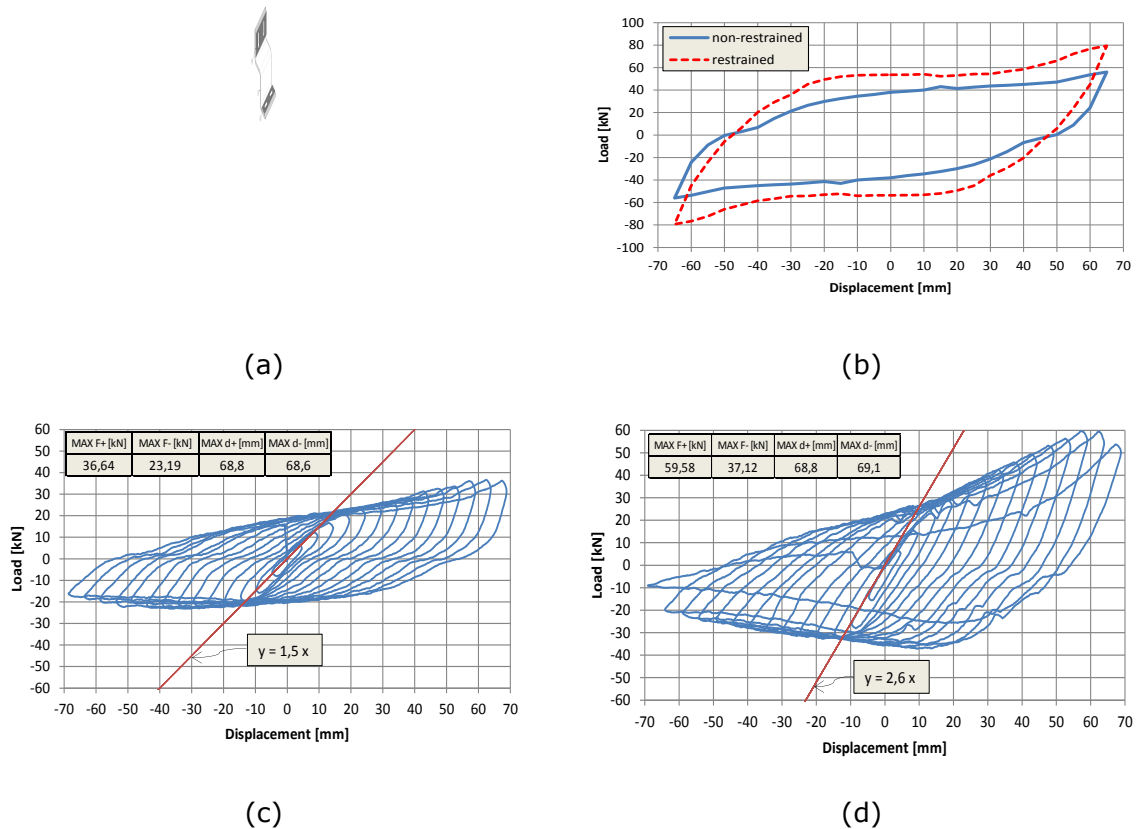

Figure 5.21

The fasteners shall be over-proportioned by capacity design with reference to the mean plastic moment of the plate $M_{pm} = \frac{f_{ym} L t^2}{4}$ where $f_{ym} = 1,08 f_{yk}$ using the factor $\gamma_R = 1,2$. The corresponding forces $F_x = \frac{2\gamma_R M_{pm}}{b}$ and $F_{xy} = \frac{2\gamma_R M_{pm}}{a}$ shall be compared to the pertinent pull-out or shear strength of the column or panel fasteners. In case of out-of-plane displacement restrained, $\gamma_R = 2,0$ should be taken because of the strong hardening effects.

ANNEX A: Capacity and stiffness of a typical restraining device

Many different concepts and technological solutions for synthetic and steel restrainers have been recently tested. The results for only one of the best solutions are provided in the following text for the illustration of typical capacity.

In Figure A1 the results of the experimental tests on 8 mm synthetic fibre ropes with resin potted end terminations are presented. Synthetic fibre ropes used were:

Svec8 – 8 mm LCP synthetic fibre rope

Sdyn8 – 8 mm UHMWPE

Best results were achieved with Sdyn8 rope. Measured average strength and stiffness were 46.6kN and 1806kN/m, respectively.

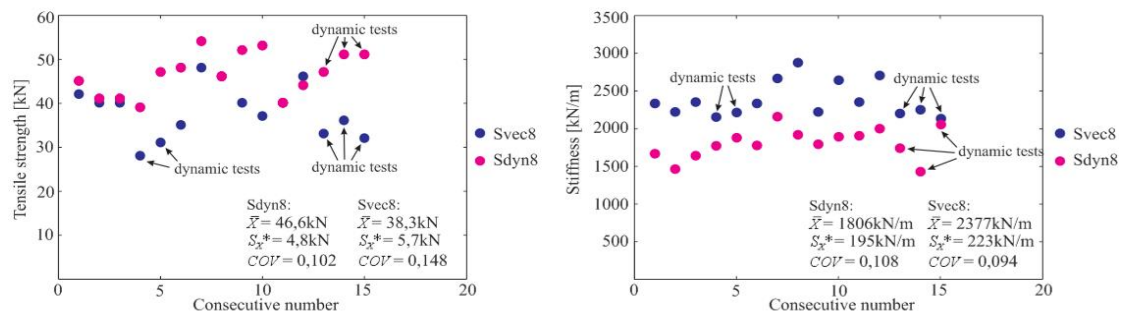

Figure A1 Strength capacity and stiffness for Sdyn8 rope

Europe Direct is a service to help you find answers to your questions about the European Union

Free phone number (*): 00 800 6 7 8 9 10 11

(*): Certain mobile telephone operators do not allow access to 00 800 numbers or these calls may be billed.

A great deal of additional information on the European Union is available on the Internet.

It can be accessed through the Europa server <http://europa.eu>

How to obtain EU publications

Our publications are available from EU Bookshop (<http://bookshop.europa.eu>), where you can place an order with the sales agent of your choice.

The Publications Office has a worldwide network of sales agents.

You can obtain their contact details by sending a fax to (352) 29 29-42758.

JRC Mission

As the Commission's in-house science service, the Joint Research Centre's mission is to provide EU policies with independent, evidence-based scientific and technical support throughout the whole policy cycle.

Working in close cooperation with policy Directorates-General, the JRC addresses key societal challenges while stimulating innovation through developing new methods, tools and standards, and sharing its know-how with the Member States, the scientific community and international partners.

*Serving society
Stimulating innovation
Supporting legislation*

doi:10.2788/546845

ISBN 978-92-79-58533-3

