



JRC SCIENCE FOR POLICY REPORT

Best Available Techniques (BAT) Reference Document for Large Combustion Plants

*Industrial Emissions Directive
2010/75/EU
(Integrated Pollution
Prevention and Control)*

Thierry Lecomte, José Félix Ferrería de la Fuente, Frederik Neuwahl, Michele Canova, Antoine Pinasseau, Ivan Jankov, Thomas Brinkmann, Serge Roudier, Luis Delgado Sancho

2017



Best Available Techniques (BAT) Reference Document for Large Combustion Plants

Industrial Emissions Directive 2010/75/EU
Integrated Pollution Prevention and control

Authors:

Thierry Lecomte
José Félix Ferrería de la
Fuente Frederik Neuwahl
Michele Canova
Antoine Pinasseau
Ivan Jankov
Thomas Brinkmann
Serge Roudier
Luis Delgado Sancho

2017

EUR 28836 EN

This publication is a Science for Policy report by the Joint Research Centre (JRC), the European Commission's science and knowledge service. It aims to provide evidence-based scientific support to the European policy-making process. The scientific output expressed does not imply a policy position of the European Commission. Neither the European Commission nor any person acting on behalf of the Commission is responsible for the use which might be made of this publication.

Contact information

Name: European IPPC Bureau

Address: Joint Research Centre, Edificio Expo c/ Inca Garcilaso 3, E-41092 Seville, Spain

E-mail: JRC-B5-EIPPCB@ec.europa.eu

Tel.: +34 95 4488 284

JRC Science Hub

<https://ec.europa.eu/jrc>

Legal Notice

Under the Commission Decision of 12 December 2011 on the Re-use of Commission Documents (2011/833/EU), the present BREF document is subject to free re-use, except for parts covered by any third-party rights which may be present in the document (such as images, tables, data, written material, or similar, the rights to which need to be acquired separately from their respective rights-holders for further use). The European Commission is not liable for any consequence stemming from the re-use of this publication. Any re-use is subject to the acknowledgement of the source and non-distortion of the original meaning or message.

JRC107769

EUR 28836 EN

PDF ISBN 978-92-79-74303-0 ISSN 1831-9424 doi:10.2760/949

Luxembourg: Publications Office of the European Union, 2017

© European Union, 2017

How to cite this report: Thierry Lecomte, José Félix Ferrería de la Fuente, Frederik Neuwahl, Michele Canova, Antoine Pinasseau, Ivan Jankov, Thomas Brinkmann, Serge Roudier, Luis Delgado Sancho; *Best Available Techniques (BAT) Reference Document for Large Combustion Plants*; EUR 28836 EN; doi:10.2760/949

All images © European Union, 2017, except cover picture credits: Coal power plant at sunrise © fotolia.com (stock.adobe.com)

Title Best Available Techniques (BAT) Reference Document for Large Combustion Plants

Abstract

The BAT Reference Document (BREF) for Large Combustion Plants is part of a series of documents presenting the results of an exchange of information between the EU Member States, the industries concerned, non-governmental organisations promoting environmental protection, and the Commission, to draw up, review, and -where necessary- update BAT reference documents as required by Article 13(1) of Directive 2010/75/EU on Industrial Emissions. This document is published by the European Commission pursuant to Article 13(6) of the Directive.

This BREF for Large Combustion Plants concerns the following activities specified in Annex I to Directive 2010/75/EU:

- 1.1: Combustion of fuels in installations with a total rated thermal input of 50 MW or more, only when this activity takes place in combustion plants with a total rated thermal input of 50 MW or more.
- 1.4: Gasification of coal or other fuels in installations with a total rated thermal input of 20 MW or more, only when this activity is directly associated to a combustion plant.
- 5.2: Disposal or recovery of waste in waste co-incineration plants for non-hazardous waste with a capacity exceeding 3 tonnes per hour or for hazardous waste with a capacity exceeding 10 tonnes per day, only when this activity takes place in combustion plants covered under 1.1 above.

In particular, this document covers upstream and downstream activities directly associated with the aforementioned activities including the emission prevention and control techniques applied.

The fuels considered in this document are any solid, liquid and/or gaseous combustible material including:

- solid fuels (e.g. coal, lignite, peat);
- biomass (as defined in Article 3(31) of Directive 2010/75/EU);
- liquid fuels (e.g. heavy fuel oil and gas oil);
- gaseous fuels (e.g. natural gas, hydrogen-containing gas and syngas);
- industry-specific fuels (e.g. by-products from the chemical and iron and steel industries);
- waste except mixed municipal waste as defined in Article 3(39) and except other waste listed in Article 42(2)(a)(ii) and (iii) of Directive 2010/75/EU.

Important issues for the implementation of Directive 2010/75/EU in the Large Combustion Plants sector are the emissions to air of nitrogen oxides, sulphur dioxide, hydrogen chloride and fluoride, organic compounds, dust, and metals including mercury; emissions to water resulting especially from the use of wet abatement techniques for the removal of sulphur dioxide from the flue-gases; resource efficiency and especially energy efficiency.

This BREF contains 12 chapters. Chapters 1 and 2 provide general information on the Large Combustion Plants industrial sector and on the industrial processes used within this sector. Chapter 3 provides data and general information concerning the environmental performance of installations within the sector in terms of water consumption, the generation of waste and general techniques used within this sector. It also describes in more detail the general techniques to prevent or, where this is not practicable, to reduce the environmental impact of installations in this sector that were considered in determining the BAT. Chapters 4 to 9 provide the following information given below on specific combustion processes (gasification, combustion of solid fuel, combustion of liquid fuel, combustion of gaseous fuel, multi-fuel combustion and waste co-incineration). Chapter 10 presents the BAT conclusions as defined in Article 3(12) of the Directive. Chapter 11 presents information on 'emerging techniques' as defined in Article 3(14) of the Directive. Chapter 12 is dedicated to concluding remarks and recommendations for future work.

Printed in Ispra (Italy)

Acknowledgements

This report was produced by the European Integrated Pollution Prevention and Control Bureau (EIPPCB) at the European Commission's Joint Research Centre – Directorate B: Growth and Innovation under the supervision of Serge Roudier (Head of the EIPPCB) and Luis Delgado Sancho (Head of the Circular Economy and Industrial Leadership Unit).

The authors of this BREF were Thierry Lecomte, José Félix Ferrería de la Fuente, Frederik Neuwahl, Michele Canova, Antoine Pinasseau, Ivan Jankov, and Thomas Brinkmann.

Directorate C: Energy, Transport and Climate of the European Commission's Joint Research Centre also supported the initial stage of this work.

This report was drawn up in the framework of the implementation of the Industrial Emissions Directive (2010/75/EU) and is the result of the exchange of information provided for in Article 13 of the Directive.

Major contributors of information were:

- among EU Member States: Austria, Belgium, the Czech Republic, Denmark, Finland, France, Germany, Greece, Italy, The Netherlands, Poland, Portugal, Spain, Sweden, the United Kingdom;
- among industrial associations: CEFIC, CEPI, Euracoal, Eurelectric, EUROFER, EUROMOT, EPPSA, European Turbines Network, Euroheat & Power, EU Turbines, International Association of Oil & Gas, MARCOGAZ;
- among non-governmental organisations promoting environmental protection: European Environmental Bureau.

Other contributors to the review process were: Bulgaria, Croatia, Cyprus, Estonia, Hungary, Ireland, Malta, Norway, Romania, Serbia, Slovenia, Slovakia, Turkey, CEMBUREAU, CEWEP, CONCAWE, COGEN Europe, ESWET, Eurogypsum, Fuels Europe, Hazardous Waste Europe, Orgalime, Climate Action Network, RAP Online.

The whole EIPPCB team provided contributions and peer reviewing.

This document is one from the series of foreseen documents listed below (at the time of writing, not all documents have been drafted):

Best Available Techniques Reference Document	Code
Ceramic Manufacturing Industry	CER
Common Waste Water and Waste Gas Treatment/Management Systems in the Chemical Sector	CWW
Common Waste Gas Treatment in the Chemical Sector	WGC
Emissions from Storage	EFS
Energy Efficiency	ENE
Ferrous Metals Processing Industry	FMP
Food, Drink and Milk Industries	FDM
Industrial Cooling Systems	ICS
Intensive Rearing of Poultry or Pigs	IRPP
Iron and Steel Production	IS
<i>Large Combustion Plants</i>	<i>LCP</i>
Large Volume Inorganic Chemicals – Ammonia, Acids and Fertilisers	LVIC-AAF
Large Volume Inorganic Chemicals – Solids and Others Industry	LVIC-S
Large Volume Organic Chemical Industry	LVOC
Management of Tailings and Waste-rock in Mining Activities	MTWR
Manufacture of Glass	GLS
Manufacture of Organic Fine Chemicals	OFC
Non-ferrous Metals Industries	NFM
Production of Cement, Lime and Magnesium Oxide	CLM
Production of Chlor-alkali	CAK
Production of Polymers	POL
Production of Pulp, Paper and Board	PP
Production of Speciality Inorganic Chemicals	SIC
Production of Wood-based Panels	WBP
Refining of Mineral Oil and Gas	REF
Slaughterhouses and Animals By-products Industries	SA
Smitheries and Foundries Industry	SF
Surface Treatment of Metals and Plastics	STM
Surface Treatment Using Organic Solvents (including Wood and Wood Products Preservation with Chemicals)	STS
Tanning of Hides and Skins	TAN
Textiles Industry	TXT
Waste Incineration	WI
Waste Treatment	WT
Reference Document	
Economics and Cross-media Effects	ECM
Monitoring of Emissions to Air and Water from IED installations	ROM

Electronic versions of draft and finalised documents are publicly available and can be downloaded from <http://eippcb.jrc.ec.europa.eu/>.

PREFACE

1. Status of this document

Unless otherwise stated, references to ‘the Directive’ in this document refer to Directive 2010/75/EU of the European Parliament and the Council on industrial emissions (integrated pollution prevention and control) (Recast).

The original best available techniques (BAT) reference document (BREF) on Large Combustion Plants was adopted by the European Commission in 2006. This document is the result of a review of that BREF. The review commenced in March 2011.

This BAT reference document for Large Combustion Plants forms part of a series presenting the results of an exchange of information between EU Member States, the industries concerned, non-governmental organisations promoting environmental protection and the Commission, to draw up, review, and where necessary, update BAT reference documents as required by Article 13(1) of the Directive. This document is published by the European Commission pursuant to Article 13(6) of the Directive.

As set out in Article 13(5) of the Directive, the Commission Implementing Decision (EU) 2017/1442 on the BAT conclusions contained in Chapter 10 was adopted on 31 July 2017 and published on 17 August 2017¹.

2. Participants in the information exchange

As required in Article 13(3) of the Directive, the Commission has established a forum to promote the exchange of information, which is composed of representatives from Member States, the industries concerned and non-governmental organisations promoting environmental protection (Commission Decision of 16 May 2011 establishing a forum for the exchange of information pursuant to Article 13 of the Directive 2010/75/EU on industrial emissions (2011/C 146/03), OJ C 146, 17.05.2011, p. 3).

Forum members have nominated technical experts constituting the technical working group (TWG) that was the main source of information for drafting this document. The work of the TWG was led by the European IPPC Bureau (of the Commission's Joint Research Centre).

3. Structure and contents of this document

Chapters 1 and 2 provide general information on the Large Combustion Plants industrial sector and on the industrial processes used within this sector. These are horizontal matters or specific activities that do not relate to one specific combustion activity.

Chapter 3 provides data and general information concerning the environmental performance of installations within the sector, and in operation at the time of writing, in terms of water consumption, the generation of waste and general techniques used within this sector. It also describes in more detail the general techniques to prevent or, where this is not practicable, to reduce the environmental impact of installations in this sector that were considered in determining the BAT.

Chapters 4 to 9 provide the following information given below on specific combustion processes (gasification, combustion of solid fuel, combustion of liquid fuel, combustion of gaseous fuel, multi-fuel combustion and waste co-incineration). For each combustion process (X is the chapter or section number):

¹ OJ L 212, 17.08.2017, p. 1.

- Section X.1 provides information on applied processes and techniques.
- Section X.2 provides data and information concerning the environmental performance of installations within the sector, and in operation at the time of writing, in terms of current emissions, consumption and nature of raw materials, and use of energy.
- Section X.3 describes in more detail the techniques to prevent or, where this is not practicable, to reduce the environmental impact of operating installations in this sector that were considered in determining the BAT. This information includes, where relevant, the environmental performance levels (e.g. emission and consumption levels) which can be achieved by using the techniques, the associated monitoring, the costs and the cross-media issues associated with the techniques.

Chapter 10 presents the BAT conclusions as defined in Article 3(12) of the Directive.

Chapter 11 presents information on 'emerging techniques' as defined in Article 3(14) of the Directive.

Concluding remarks and recommendations for future work are presented in Chapter 12.

4. Information sources and the derivation of BAT

This document is based on information collected from a number of sources, in particular through the TWG that was established specifically for the exchange of information under Article 13 of the Directive. The information has been collated and assessed by the European IPPC Bureau (of the Commission's Joint Research Centre) who led the work on determining BAT, guided by the principles of technical expertise, transparency and neutrality. The work of the TWG and all other contributors is gratefully acknowledged.

The BAT conclusions have been established through an iterative process involving the following steps:

- identification of the key environmental issues for the Large Combustion Plants sector;
- examination of the techniques most relevant to address these key issues;
- identification of the best environmental performance levels, on the basis of the available data in the European Union and worldwide;
- examination of the conditions under which these environmental performance levels were achieved, such as costs, cross-media effects, and the main driving forces involved in the implementation of the techniques;
- selection of the best available techniques (BAT), their associated emission levels (and other environmental performance levels) and the associated monitoring for this sector according to Article 3(10) of, and Annex III to, the Directive.

Expert judgement by the European IPPC Bureau and the TWG has played a key role in each of these steps and the way in which the information is presented here.

Where available, economic data have been given together with the descriptions of the techniques presented in Chapters 4 to 9. These data give a rough indication of the magnitude of the costs and benefits. However, the actual costs and benefits of applying a technique may depend strongly on the specific situation of the installation concerned, which cannot be evaluated fully in this document. In the absence of data concerning costs, conclusions on the economic viability of techniques are drawn from observations on existing installations.

5. Review of BAT reference documents (BREFs)

BAT is a dynamic concept and so the review of BREFs is a continuing process. For example, new measures and techniques may emerge, science and technologies are continuously developing and new or emerging processes are being successfully introduced into the industries. In order to reflect such changes and their consequences for BAT, this document will be periodically reviewed and, if necessary, updated accordingly.

6. Contact information

All comments and suggestions should be made to the European IPPC Bureau at the Joint Research Centre (JRC) at the following address:

European Commission
JRC Directorate B – Growth and Innovation
European IPPC Bureau
Edificio Expo
c/Inca Garcilaso, 3
E-41092 Seville, Spain
Telephone: +34 95 4488 284
Fax: +34 95 4488 426
E-mail: JRC-B5-EIPPCB@ec.europa.eu
Internet: <http://eippcb.jrc.ec.europa.eu>

Reference Document on Best Available Techniques for Large Combustion Plants

PREFACE	I
SCOPE	XXXIII
1 GENERAL INFORMATION ON THE STRUCTURE OF THE SECTOR	1
1.1 INDUSTRY OVERVIEW.....	1
1.2 ECONOMIC SITUATION.....	12
1.3 KEY ENVIRONMENTAL ISSUES.....	16
1.3.1 Energy efficiency.....	17
1.3.2 Emissions to air.....	18
1.3.2.1 Sulphur oxides (SO _x).....	19
1.3.2.2 Nitrogen oxides (NO _x)	20
1.3.2.3 Dust.....	23
1.3.2.4 Metals	24
1.3.2.5 Carbon monoxide (CO)	26
1.3.2.6 Greenhouse gases.....	28
1.3.2.7 Hydrogen chloride (HCl).....	30
1.3.2.8 Hydrogen fluoride (HF).....	31
1.3.2.9 Ammonia (NH ₃).....	32
1.3.2.10 Volatile organic compounds (VOCs).....	32
1.3.2.11 Persistent organic pollutants (POPs): polycyclic aromatic hydrocarbons (PAHs), dioxins and furans.....	33
1.3.3 Emissions to water	34
1.3.4 Combustion residues.....	36
1.3.5 Noise and vibration.....	38
1.3.6 Emissions of radioactive substances.....	38
1.3.7 Mitigation of environmental impacts.....	39
1.3.8 Introduction to the integrated approach of protecting the environment as a whole.....	39
1.3.9 Plant-specific data collection for the LCP sector.....	40
2 PROCESSES FOR ENERGY GENERATION	43
2.1 COMBUSTION PRINCIPLES	43
2.2 COMMON TECHNICAL COMBUSTION PROCESSES.....	44
2.2.1 General fuel heat conversion	44
2.2.2 Pulverised and atomised firing	44
2.2.3 Fluidised bed combustion	47
2.2.3.1 Bubbling fluidised bed combustion (BFBC)	49
2.2.3.2 Circulating fluidised bed combustion (CFBC)	49
2.2.3.3 Pressurised fluidised bed combustion (PFBC)	52
2.2.3.4 NO _x and N ₂ O control in fluidised bed combustion	53
2.2.4 Grate firing of solid fuels.....	53
2.3 DIRECT CONVERSION	56
2.3.1 General.....	56
2.3.2 Combustion engines.....	56

2.3.2.1	Diesel engines	57
2.3.2.2	Spark-ignited (SG-type) engines	57
2.3.2.3	Low-pressure dual fuel (DF-type) engines.....	57
2.3.2.4	High-pressure gas diesel (GD-type) engines	58
2.3.3	Gas turbines.....	58
2.4	STEAM PROCESSES	64
2.4.1	General	64
2.4.1.1	Typical elements of a steam cycle.....	64
2.4.1.1.1	Boiler.....	66
2.4.1.1.2	Steam turbine.....	67
2.4.1.1.3	Condenser.....	67
2.4.1.1.4	Cooling system.....	68
2.4.2	Vacuum condensing power plant	68
2.4.3	Combined cycle.....	68
2.4.4	Supplementary firing of combined-cycle gas turbines.....	69
2.4.5	Repowering of existing power plants.....	70
2.5	COGENERATION OR COMBINED HEAT AND POWER (CHP).....	71
2.6	INTEGRATED GASIFICATION COMBINED CYCLE.....	77
2.7	ENERGY EFFICIENCY.....	78
2.7.1	Carnot efficiency	79
2.7.2	Thermal efficiency	80
2.7.3	Electrical efficiency.....	80
2.7.4	Mechanical efficiency	82
2.7.5	Operating (annual) energy efficiency.....	83
2.7.6	Total fuel utilisation	84
2.7.7	Unit efficiency for steam withdrawal.....	85
2.7.8	Exergy concept and exergy efficiency	85
2.7.9	Influence of climate conditions on efficiency	88
2.7.10	Relationship between energy efficiency and environmental issues	90
2.7.10.1	Impact of the abatement techniques on plant energy efficiency.....	90
2.7.10.2	Effect of increasing the plant energy efficiency on emission levels.....	91
2.7.11	Losses of efficiency in combustion plants	91
2.7.12	General technical measures to improve LCP efficiency	92
2.8	UNLOADING, STORAGE AND HANDLING OF FUEL AND ADDITIVES	94
2.8.1.1	Solid fuels and additives	94
2.8.1.2	Liquid fuels	97
2.8.1.3	Gaseous fuels	98
3	GENERAL TECHNIQUES TO PREVENT AND/OR REDUCE EMISSIONS AND CONSUMPTION	101
3.1	APPLIED COMMON TECHNIQUES	101
3.1.1	General primary techniques to reduce emissions/consumption	101
3.1.1.1	Cogeneration or combined heat and power (CHP).....	101
3.1.1.2	Integrated gasification combined cycle	101
3.1.1.3	Combined-cycle combustion.....	101
3.1.1.4	Fuel switch or choice	101
3.1.1.5	Combustion modifications (process control).....	102

3.1.2	Techniques to prevent and/or reduce dust emissions.....	104
3.1.3	Techniques to prevent and/or reduce SO _x emissions	105
3.1.3.1	Wet scrubbers	106
3.1.3.2	Semi-dry scrubbers	107
3.1.3.3	Sorbent injection	107
3.1.4	Techniques to prevent and/or reduce NO _x emissions.....	108
3.1.4.1	Primary techniques to reduce NO _x emissions	109
3.1.4.2	Secondary techniques to reduce NO _x emissions	110
3.1.4.2.1	Trade-offs between NO _x abatement, CO/dust emissions and/or energy consumption.....	111
3.1.5	Combined techniques to prevent and/or reduce SO _x and NO _x emissions.....	111
3.1.5.1	Solid adsorption/regeneration	112
3.1.5.1.1	Activated carbon process	112
3.1.5.1.2	Other solid adsorption/regenerative processes	113
3.1.5.2	Gas/solid catalytic processes	113
3.1.6	Techniques to prevent and/or reduce metal emissions.....	114
3.1.7	Techniques to prevent and/or reduce emissions of CO and unburnt hydrocarbons.....	115
3.1.8	Techniques to prevent and/or reduce halide emissions.....	115
3.1.9	Techniques to reduce greenhouse gas (GHG) emissions from large combustion plants	115
3.1.10	Water use and techniques to reduce emissions to water	116
3.1.10.1	Waste water from raw water treatment plants	118
3.1.10.2	Waste water from cooling circuit systems	118
3.1.10.3	Waste water from steam generation processes	119
3.1.10.4	Waste water from flue-gas treatment systems	119
3.1.10.5	Acid washing water	123
3.1.10.6	Sanitary waste water	124
3.1.10.7	Other waste waters.....	124
3.1.11	Techniques to control releases to land/soils and for the management of residues	124
3.1.12	Techniques to reduce noise emissions	125
3.1.13	Cooling techniques	127
3.1.14	Emission monitoring and reporting	127
3.1.14.1	Emission components	127
3.1.14.2	Reference conditions and parameters	128
3.1.14.3	Sampling points	129
3.1.14.4	Monitoring of emissions	129
3.1.14.4.1	Continuous monitoring	129
3.1.14.4.2	Periodic monitoring	130
3.1.14.4.3	Indirect monitoring using surrogate parameters	130
3.1.15	Influence of load factors and modes on environmental performances	131
3.1.16	Other than normal operating conditions (OTNOC).....	132
3.2	TECHNIQUES TO CONSIDER IN THE DETERMINATION OF GENERAL BAT FOR THE LCP SECTOR.....	134
3.2.1	Environmental management systems.....	134
3.2.2	Techniques to prevent and/or reduce channelled emissions to air.....	138
3.2.2.1	Techniques to prevent and/or reduce dust emissions.....	138
3.2.2.1.1	Electrostatic precipitators (ESPs)	138
3.2.2.1.2	Bag filters.....	143

3.2.2.1.3	Centrifugal precipitation (cyclones)	148
3.2.2.1.4	Wet scrubbers	149
3.2.2.2	Techniques to prevent and/or reduce SO _x emissions	153
3.2.2.2.1	Wet lime/limestone scrubbers	153
3.2.2.2.2	Seawater scrubber	164
3.2.2.2.3	Magnesium wet scrubber	166
3.2.2.2.4	Ammonia wet scrubber	167
3.2.2.2.5	Lye wet scrubber	169
3.2.2.2.6	Spray dry scrubber/absorber	170
3.2.2.2.7	Circulating fluidised bed (CFB) dry scrubber	175
3.2.2.2.8	Duct sorbent injection	178
3.2.2.2.9	Use of sorbents in fluidised bed combustion systems	182
3.2.2.2.10	Furnace sorbent injection in pulverised combustion boilers	183
3.2.2.2.11	Hybrid sorbent injection	187
3.2.2.2.12	Magnesium oxide process	188
3.2.2.3	Techniques to prevent and/or reduce NO _x emissions	189
3.2.2.3.1	Low excess air firing	189
3.2.2.3.2	Air staging	191
3.2.2.3.3	Flue-gas recirculation (FGR) or exhaust gas recirculation (EGR)	195
3.2.2.3.4	Reduction of combustion air temperature	198
3.2.2.3.5	Low-NO _x burners	199
3.2.2.3.6	Fuel staging (reburning)	205
3.2.2.3.7	Dry low-NO _x (DLN) burners	208
3.2.2.3.8	Low-NO _x combustion concept in engines	211
3.2.2.3.9	Lean-burn concept	212
3.2.2.3.10	Water/steam addition	214
3.2.2.3.11	Selective catalytic reduction (SCR)	218
3.2.2.3.12	Selective non-catalytic reduction (SNCR)	230
3.2.2.3.13	Ammonia-related issues when using SCR/SNCR techniques	234
3.2.2.4	Combined techniques to prevent and/or reduce SO _x , NO _x and other pollutant emissions	236
3.2.2.4.1	Activated carbon process	236
3.2.2.4.2	WSA-SNO _x process	237
3.2.2.4.3	DeSONO _x process	240
3.2.2.5	Techniques to prevent and/or reduce metal emissions	242
3.2.2.5.1	Reduction of metal emissions in dust abatement systems	242
3.2.2.5.2	Reduction of metal emissions in FGD systems	244
3.2.2.5.3	Reduction of metal emissions in NO _x control systems	247
3.2.2.5.4	Reduction of metal emissions by specifically designed systems	248
3.2.2.5.5	Reduction of metal emissions by use of a metal separator in the fuel supply line	249
3.2.2.6	Techniques to prevent and/or reduce HCl and HF emissions	250
3.2.2.6.1	Co-benefit of techniques designed for other pollutants	250
3.2.2.6.2	Wet scrubbing	251
3.2.2.7	Techniques to reduce unburnt carbon	253
3.2.2.7.1	Combustion optimisation	253
3.2.2.7.2	Oxidation catalyst	253
3.2.3	Techniques to increase energy efficiency	254
3.2.3.1	Heat recovery techniques	254
3.2.3.2	Cogeneration or combined heat and power (CHP)	255
3.2.3.3	Cheng Cycle	259
3.2.3.4	Combustion air preheating	262
3.2.3.5	Advanced material use	263
3.2.3.6	Steam double reheating	264

3.2.3.7	Feed-water preheating using recovered heat.....	264
3.2.3.8	Advanced control system.....	266
3.2.3.9	Heat accumulation (heat storage) in CHP or heat-only mode.....	269
3.2.3.10	Integrated gasification combined cycle (IGCC)	270
3.2.3.11	Combined-cycle combustion	270
3.2.3.12	Topping cycle	272
3.2.3.13	Steam turbine and other component upgrades	275
3.2.3.14	(Ultra-) Supercritical steam parameters	276
3.2.3.15	Flue-gas condenser	278
3.2.3.16	Cooling tower air emission discharge.....	279
3.2.3.17	Wet stack	280
3.2.3.18	Fuel preheating/drying.....	281
3.2.3.19	Cooling system	282
3.2.4	Techniques to prevent and/or reduce emissions to water	282
3.2.4.1	Filtration	284
3.2.4.2	Coagulation, flocculation, sedimentation and precipitation.....	285
3.2.4.3	Flotation.....	286
3.2.4.4	Oil-water separation.....	287
3.2.4.5	Crystallisation.....	288
3.2.4.6	Evaporation.....	289
3.2.4.7	Air stripping.....	290
3.2.4.8	Ion exchange.....	291
3.2.4.9	Biological treatment.....	292
3.2.4.10	Techniques to consider for plants equipped with flue-gas treatment with emissions to water (Wet FGD, FG condenser)	293
3.2.5	Techniques for the management of residues.....	305
3.2.5.1	Optimisation of gypsum quality	305
3.2.5.2	Optimisation of bottom ash quality	306
3.2.6	Techniques to prevent emissions to soil and groundwater	307
3.2.7	Techniques to reduce noise emissions	307
3.2.7.1	Strategic planning of the location of equipment, units and buildings	307
3.2.7.2	Primary techniques: noise reduction at source.....	308
3.2.7.3	Secondary techniques: noise abatement.....	310
4	GASIFICATION.....	313
4.1	APPLIED PROCESSES AND TECHNIQUES.....	316
4.1.1	IGCC (Integrated gasification combined cycle) plants.....	317
4.1.2	Biomass gasifiers	325
4.1.3	Plasma gasification of waste material.....	329
4.2	CURRENT EMISSION AND CONSUMPTION LEVELS	330
4.2.1	Residues	335
4.2.2	Consumption of water, chemicals and energy	336
4.2.3	Emissions to land/soil	337
4.3	TECHNIQUES TO CONSIDER IN THE DETERMINATION OF BAT FOR GASIFICATION....	338
4.3.1	Gasification integrated with the combustion process	338
4.3.1.1	Prevention of emissions and efficient energy use in coal- and multi-fuel-based integrated gasification combined cycle (IGCC) plants	338
4.3.1.2	Reduction of emissions from a gasifier connected to an existing coal boiler	345
4.3.1.3	Biomass gasification connected to engine plants with prior wet gas cleaning	349

4.3.2	Techniques to prevent and/or control water pollution from the gasification process.....	351
4.3.3	Techniques for the management of residues from the gasification process	352
4.3.4	Techniques to increase the energy efficiency of the gasification process.....	353
4.3.4.1	High-temperature and -pressure gasification.....	353
4.3.4.2	Dry feedstock feeding system	354
4.3.4.3	Use of recovered heat from the gasification process	354
4.3.4.4	Full integration of the air supply unit (ASU) with the gas turbine in IGCC plants	355
5	COMBUSTION OF SOLID FUELS	357
5.1	COMBUSTION OF COAL AND/OR LIGNITE	357
5.1.1	Applied processes and techniques.....	359
5.1.1.1	Fuel characterisation	360
5.1.1.2	Pretreatment and preparation of coal and lignite.....	365
5.1.1.3	Energy efficiency of coal- and/or lignite-fired LCP boilers.....	367
5.1.1.4	Control of emissions to air from coal- and/or lignite-fired LCPs.....	368
5.1.1.4.1	Control of emissions from pulverised fuel combustion.....	368
5.1.1.4.2	Control of emissions from fluidised bed combustion.....	372
5.1.1.4.3	Control of emissions from grate firing	373
5.1.1.4.4	Control of mercury (Hg) emissions from coal- and/or lignite-fired LCPs ...	373
5.1.1.5	Water and waste water treatment	376
5.1.1.6	Treatment of combustion residues	376
5.1.2	Current emission and consumption levels.....	379
5.1.2.1	Coal and lignite used in LCPs	379
5.1.2.2	Energy efficiency of coal- and lignite-fired combustion plants	382
5.1.2.3	Emissions to air (coal/lignite)	386
5.1.2.4	Combustion residues	394
5.1.3	Techniques to consider in the determination of BAT for the combustion of coal and/or lignite.....	399
5.1.3.1	Techniques to control diffuse emissions from the unloading, storage and handling of fuel/additives.....	400
5.1.3.2	Techniques to improve the general environmental performance	403
5.1.3.3	Techniques to increase energy efficiency and fuel utilisation.....	406
5.1.3.4	Techniques to prevent and/or control dust and metal emissions	412
5.1.3.4.1	General techniques for the prevention and control of dust and particle-bound metal emissions	412
5.1.3.4.2	General techniques for the prevention and control of mercury emissions....	417
5.1.3.4.3	Specific techniques for the prevention and control of mercury emissions ...	421
5.1.3.4.3.1	Fuel pretreatment.....	421
5.1.3.4.3.2	Carbon sorbent injection.....	423
5.1.3.4.3.3	Use of halogenated additives (e.g. bromide)	428
5.1.3.4.3.4	Other specific techniques for the prevention and control of gaseous mercury.....	430
5.1.3.5	Techniques to prevent and/or control SO _x , HCl and HF emissions.....	432
5.1.3.5.1	General techniques for the prevention and control of SO _x , HCl and HF emissions	432
5.1.3.5.2	Replacement of the gas-gas heater located downstream of the wet FGD.....	439
5.1.3.6	Techniques to prevent and/or control NO _x , CO and N ₂ O emissions	441
5.1.3.6.1	General techniques for the prevention and control of NO _x , CO and N ₂ O emissions	441
5.1.3.6.2	Thermal input biasing and dynamic classifiers for the prevention and control of NO _x at downshot boilers combusting low volatile coals	447

5.2	COMBUSTION OF BIOMASS AND PEAT	449
5.2.1	Applied processes and techniques	449
5.2.1.1	Fuel characterisation of biomass and/or peat.....	449
5.2.1.2	Fuel pretreatment and preparation	449
5.2.1.3	Combustion technologies specific to biomass and/or peat firing.....	450
5.2.1.3.1	Grate firing.....	450
5.2.1.3.2	Fluidised bed combustion	452
5.2.1.3.3	Pulverised peat and/or biomass firing	453
5.2.1.4	Energy efficiency of biomass- and/or peat-fired LCP boilers	454
5.2.1.5	Control of emissions to air from biomass- and/or peat-fired plants.....	455
5.2.1.5.1.1	Control of nitrogen oxides emissions.....	455
5.2.1.5.1.2	Control of SO _x emissions.....	456
5.2.1.5.1.3	Dust control.....	456
5.2.1.6	Water and waste water treatment.....	458
5.2.1.7	Management of combustion residues.....	458
5.2.2	Current emission and consumption levels	458
5.2.2.1	Biomass and peat used in large combustion plants.....	458
5.2.2.2	Energy efficiency of biomass- and peat-fired combustion plants	461
5.2.2.3	Emissions to air from biomass- and/or peat-fired combustion plants	462
5.2.2.4	Combustion and other plant residues.....	465
5.2.3	Techniques to consider in the determination of BAT for the combustion of biomass and/or peat	466
5.2.3.1	Techniques to reduce diffuse/fugitive emissions to air.....	466
5.2.3.2	Techniques to improve the general environmental performance	468
5.2.3.3	Techniques to increase energy efficiency	470
5.2.3.4	Techniques to prevent and/or control NO _x , N ₂ O and CO emissions	473
5.2.3.5	Techniques to prevent and/or control SO _x , HCl and HF emissions	478
5.2.3.6	Techniques to prevent and/or control dust and particulate-bound metal emissions	485
5.2.3.7	Techniques to prevent and/or control mercury emissions.....	489
5.2.3.8	Techniques to reduce and/or reuse combustion residues	492
6	COMBUSTION OF LIQUID FUELS.....	493
6.1	APPLIED PROCESSES AND TECHNIQUES.....	493
6.1.1	Fuel characterisation.....	493
6.1.2	Pretreatment and preparation of fuels	493
6.1.2.1	Pretreatment of fuels used in conventional boilers	493
6.1.2.2	Pretreatment of fuels used in diesel engines	493
6.1.2.3	Pretreatment of fuels for gas turbines	494
6.1.3	Combustion technologies.....	494
6.1.3.1	Design of oil-fired boilers.....	494
6.1.3.2	Compression ignition (diesel) engines.....	495
6.1.3.3	Liquid-fuel-fired gas turbines	495
6.1.4	Control of emissions to air.....	495
6.1.4.1	Primary control techniques for emissions to air from boilers	497
6.1.4.2	Primary control techniques for emissions to air from engines.....	498
6.1.4.3	Primary control techniques for emissions to air from gas turbines	499
6.1.4.4	End-of-pipe techniques to control emissions to air.....	499
6.1.4.4.1	Control of dust emissions.....	499
6.1.4.4.2	Control of SO _x emissions	500
6.1.4.4.3	Control of NO _x emissions.....	500
6.1.5	Water consumption and waste water treatment	501

6.1.6	Combustion residues treatment	502
6.2	CURRENT EMISSION AND CONSUMPTION LEVELS	503
6.2.1	Liquid fuels used in large combustion plants	503
6.2.2	Efficiency of combustion plants firing HFO and/or gas oil	504
6.2.3	Emissions to air from liquid-fuel-fired combustion plants.....	505
6.3	TECHNIQUES TO CONSIDER IN THE DETERMINATION OF BAT FOR THE COMBUSTION OF LIQUID FUELS.....	506
6.3.1	Techniques to prevent emissions to soil and groundwater.....	506
6.3.2	Techniques to consider in the determination of BAT for the combustion of HFO and/or gas oil in boilers	508
6.3.2.1	Techniques to improve the general performance	508
6.3.2.2	Techniques to increase energy efficiency.....	510
6.3.2.3	Techniques for the prevention and control of NO _x and CO emissions.....	513
6.3.2.4	Techniques for the prevention and control of SO _x emissions	517
6.3.2.5	Techniques for the prevention and control of dust and particulate-bound metals emissions.....	522
6.3.3	Techniques to consider in the determination of BAT for the combustion of HFO and/or gas oil in engines.....	525
6.3.3.1	Techniques to increase energy efficiency.....	525
6.3.3.2	Techniques to prevent and/or control NO _x and CO emissions.....	528
6.3.3.3	Techniques to prevent and/or control SO _x emissions	533
6.3.3.4	Techniques to prevent and control dust and particulate-bound metals emissions	537
6.3.4	Techniques to consider in the determination of BAT for the combustion of gas oil in gas turbines	539
6.3.4.1	Techniques to increase energy efficiency.....	539
6.3.4.2	Techniques to prevent and/or control NO _x and CO emissions	540
6.3.4.3	Techniques to prevent and/or control SO _x emissions	542
6.3.4.4	Techniques to prevent and/or control dust and particulate-bound metals emissions.....	543
7	COMBUSTION OF GASEOUS FUELS	545
7.1	COMBUSTION OF NATURAL GAS	545
7.1.1	Applied processes and techniques.....	545
7.1.1.1	Fuel characterisation	546
7.1.1.2	Control of emissions to air	547
7.1.1.2.1	Control of NO _x emissions to air from boilers	547
7.1.1.2.2	Control of NO _x emissions to air from engines	547
7.1.1.2.3	Control of NO _x emissions to air from turbines	548
7.1.1.3	Water and waste water treatment	550
7.1.2	Current emission and consumption levels.....	551
7.1.2.1	Energy efficiency of natural gas combustion plants.....	551
7.1.2.2	Emissions to air	557
7.1.2.3	Emissions to water	564
7.1.2.4	Combustion and other plant residues	564
7.1.3	Techniques to consider in the determination of BAT for the combustion of natural gas in boilers / engines / gas turbines.....	565
7.1.3.1	Techniques to increase the energy efficiency of natural-gas-fired plants	566
7.1.3.1.1	General techniques to increase the energy efficiency of natural-gas-fired units.....	566
7.1.3.1.2	Specific techniques to increase the energy efficiency of the fuel supply and handling activities	575

7.1.3.1.2.1	Use of an expansion turbine.....	575
7.1.3.1.3	Specific techniques to increase the energy efficiency of natural-gas-fired turbines	576
7.1.3.1.3.1	CHP readiness.....	576
7.1.3.1.3.2	Flow path optimisation	578
7.1.3.1.3.3	Inlet combustion air cooling	579
7.1.3.1.3.4	Recuperative gas turbine cycle	581
7.1.3.2	Techniques to prevent and/or control of NO _x and CO emissions	582
7.1.3.2.1	General techniques for the prevention and control of NO _x and CO emissions from natural-gas-fired boilers.....	582
7.1.3.2.2	General techniques for the prevention and control of NO _x and CO emissions from natural-gas-fired turbines.....	587
7.1.3.2.3	Specific techniques for the prevention and control of NO _x and CO emissions from natural-gas-fired turbines – Catalytic pollution control SCONO _x TM system.....	596
7.1.3.2.4	Prevention and control of NO _x and CO emissions from natural-gas-fired turbines at low load.....	598
7.1.3.2.4.1	Low-load operation point (LLOP)	598
7.1.3.2.4.2	Airflow control with improved inlet guided vanes (IGV).....	600
7.1.3.2.4.3	Gas turbine inlet excess air management via a bleed valve discharge	601
7.1.3.2.5	General techniques for the prevention and control of NO _x and unburnt carbon emissions from natural-gas-fired engines.....	602
7.1.3.3	Techniques to prevent emissions to soil	607
7.2	COMBUSTION OF BIOGAS.....	608
7.3	COMBUSTION OF PROCESS GASES FROM THE IRON AND STEEL INDUSTRY	609
7.3.1	Applied processes and techniques	609
7.3.1.1	Fuel characterisation and preparation/pretreatment	611
7.3.1.2	Control of emissions to air from boilers	616
7.3.1.3	Control of emissions to air from gas turbines	618
7.3.1.4	Water and waste water treatment.....	618
7.3.2	Current emission and consumption levels	619
7.3.2.1	Iron and steel process gases used in large combustion plants.....	619
7.3.2.2	Energy efficiency of iron and steel process-gas-fired combustion plants.....	620
7.3.2.3	Emissions to air	623
7.3.3	Techniques to consider in the determination of BAT for the combustion of iron and steel process gases	632
7.3.3.1	Techniques to increase energy efficiency	634
7.3.3.1.1	General techniques to increase energy efficiency	634
7.3.3.1.2	Process gas management system	636
7.3.3.2	Techniques to prevent and/or control NO _x and CO emissions	637
7.3.3.2.1	General techniques for the prevention and control of NO _x and CO emissions when firing iron and steel process gases	637
7.3.3.2.2	Specially designed low-NO _x burners in multiple rows per type of fuel or including specific features for multi-fuel firing.....	641
7.3.3.3	Techniques to prevent and/or control SO _x emissions	642
7.3.3.4	Techniques to prevent and/or control dust emissions.....	645
7.4	COMBUSTION OF GAS ON OFFSHORE PLATFORMS	648
7.4.1	Applied processes and techniques	648
7.4.1.1	Offshore combustion installations	648
7.4.1.2	Control of emissions to air.....	650
7.4.2	Current emission and consumption levels	651
7.4.2.1	Non-conventional gaseous fuels combusted.....	651

7.4.2.2	Efficiency of non-conventional gaseous fuels combustion in offshore gas turbines.....	651
7.4.3	Techniques to consider in the determination of BAT for the combustion of gas on offshore platforms.....	652
7.4.3.1	Techniques to improve the environmental performance of combustion plants used on offshore platforms.....	652
7.4.3.2	Techniques to increase energy efficiency.....	653
7.4.3.3	Techniques to prevent and/or control NO _x and CO emissions.....	655
8	MULTI-FUEL COMBUSTION	659
8.1	SOLID MULTI-FUEL COMBUSTION	659
8.1.1	Applied processes and techniques.....	659
8.1.1.1	Unloading, storage and handling.....	659
8.1.1.2	Fuels characterisation and pretreatment.....	659
8.1.1.3	Techniques to introduce the different fuels into the combustion process.....	660
8.1.1.3.1	Mixing with the main fuel.....	660
8.1.1.3.2	Dedicated burners.....	660
8.1.1.4	Solid multi-fuel combustion processes.....	661
8.1.1.4.1	Co-firing of biomass and fossil fuels.....	661
8.1.1.5	Control of emissions to air in solid multi-fuel combustion LCPs.....	663
8.1.2	Current emission and consumption levels.....	665
8.1.2.1	Degree of solid multi-fuel firing in LCPs.....	665
8.1.2.2	Effects of solid multi-fuel combustion on plant performance and efficiency.....	666
8.1.2.3	Effects of solid multi-fuel combustion on emissions to air.....	666
8.1.2.4	Effects of solid multi-fuel combustion on the quality of combustion residues.....	666
8.1.3	Techniques to consider in the determination of BAT in solid multi-fuel combustion.....	667
8.2	COMBUSTION OF LIQUID AND GASEOUS PROCESS FUELS FROM THE CHEMICAL INDUSTRY.....	668
8.2.1	Applied processes and techniques.....	668
8.2.1.1	Operating conditions.....	669
8.2.1.2	Control of NO _x , NH ₃ and CO.....	669
8.2.1.3	Control of other pollutants.....	669
8.2.2	Current emission and consumption levels.....	670
8.2.2.1	Consumption of gaseous and liquid process fuels from the chemical industry.....	670
8.2.2.1.1	Energy efficiency.....	670
8.2.2.2	Emissions.....	671
8.2.2.2.1	NO _x emissions variability.....	672
8.2.3	Techniques to consider in the determination of BAT for the combustion of process fuels from the chemical industry.....	674
8.2.3.1	Techniques to prevent and/or control NO _x , CO and NH ₃ emissions.....	674
8.2.3.2	Techniques to prevent and/or control other pollutants.....	679
9	WASTE CO-INCINERATION	683
9.1	APPLIED PROCESSES AND TECHNIQUES.....	685
9.1.1	Acceptance and pre-acceptance procedures.....	685
9.1.2	Unloading, storage and handling.....	685
9.1.3	Characterisation and pretreatment of waste streams.....	685
9.1.3.1	Milling.....	686
9.1.3.2	Drying.....	686
9.1.3.3	Pyrolysis.....	686

9.1.3.4	Gasification.....	687
9.1.3.5	Methanisation	687
9.1.4	Techniques to introduce waste into the combustion process	687
9.1.4.1	Mixing with the main fuel	687
9.1.4.2	Separate lances or modified existing burners	688
9.1.4.3	Special grates	689
9.1.4.4	Feeding wastes into a fluidised bed boiler	689
9.1.5	Control of emissions to air from waste co-incineration.....	690
9.1.6	Waste water generation and treatment.....	690
9.1.7	Management of combustion residues.....	690
9.2	CURRENT EMISSION AND CONSUMPTION LEVELS	692
9.2.1	Overview of the waste co-incinerated in LCPs.....	692
9.2.2	Degree of waste co-incinerated in LCPs.....	694
9.2.3	Effects of waste co-incineration on plant energy efficiency.....	698
9.2.4	General effects of waste co-incineration in LCPs.....	699
9.2.5	Effect of waste co-incineration on plant performance	699
9.2.6	Effects of waste co-incineration on emissions to air.....	700
9.2.6.1	Dust.....	700
9.2.6.2	Acid gases.....	700
9.2.6.3	Carbon oxides	700
9.2.6.4	Halides	701
9.2.6.5	Nitrogen oxides.....	701
9.2.6.6	Sulphur oxides	701
9.2.6.7	TOC, VOCs and dioxins.....	701
9.2.6.8	Metals (Cd+Tl; Hg; Sb+As+Pb+Cr+Co+Cu+Mn+Ni+V).....	702
9.2.6.9	Plume	702
9.2.6.10	Odour.....	702
9.2.7	Effects of waste co-incineration on emissions to water.....	702
9.2.8	Effects of waste co-incineration on the quality of combustion residues.....	703
9.3	TECHNIQUES TO CONSIDER IN THE DETERMINATION OF BAT FOR WASTE CO- INCINERATION	706
9.3.1	Techniques to control diffuse emissions and odours from the storage and handling of dusty and odorous waste.....	706
9.3.2	Techniques for the pretreatment of waste.....	708
9.3.3	Techniques to introduce waste into the combustion process	711
9.3.4	Techniques to prevent and/or control emissions to air from waste co- incineration in LCPs	712
9.3.5	Techniques to reduce the impact of waste co-incineration on the residues generated.....	726
10	BEST AVAILABLE TECHNIQUES (BAT) CONCLUSIONS.....	727
	SCOPE.....	727
	DEFINITIONS.....	729
	ACRONYMS	733
	GENERAL CONSIDERATIONS.....	734
10.1	GENERAL BAT CONCLUSIONS	737
10.1.1	Environmental management systems.....	737

10.1.2	Monitoring.....	739
10.1.3	General environmental and combustion performance.....	745
10.1.4	Energy efficiency	748
10.1.5	Water usage and emissions to water.....	750
10.1.6	Waste management	753
10.1.7	Noise emissions.....	754
10.2	BAT CONCLUSIONS FOR THE COMBUSTION OF SOLID FUELS	755
10.2.1	BAT conclusions for the combustion of coal and/or lignite.....	755
10.2.1.1	General environmental performance	755
10.2.1.2	Energy efficiency	755
10.2.1.3	NO _x , N ₂ O and CO emissions to air.....	757
10.2.1.4	SO _x , HCl and HF emissions to air	759
10.2.1.5	Dust and particulate-bound metal emissions to air.....	761
10.2.1.6	Mercury emissions to air.....	762
10.2.2	BAT conclusions for the combustion of solid biomass and/or peat.....	763
10.2.2.1	Energy efficiency	763
10.2.2.2	NO _x , N ₂ O and CO emissions to air.....	764
10.2.2.3	SO _x , HCl and HF emissions to air.....	765
10.2.2.4	Dust and particulate-bound metal emissions to air.....	767
10.2.2.5	Mercury emissions to air.....	768
10.3	BAT CONCLUSIONS FOR THE COMBUSTION OF LIQUID FUELS	769
10.3.1	HFO- and/or gas-oil-fired boilers.....	769
10.3.1.1	Energy efficiency	769
10.3.1.2	NO _x and CO emissions to air.....	770
10.3.1.3	SO _x , HCl and HF emissions to air	772
10.3.1.4	Dust and particulate-bound metal emissions to air.....	773
10.3.2	HFO- and/or gas-oil-fired engines	773
10.3.2.1	Energy efficiency	774
10.3.2.2	NO _x , CO and volatile organic compound emissions to air	775
10.3.2.3	SO _x , HCl and HF emissions to air	776
10.3.2.4	Dust and particulate-bound metal emissions to air.....	777
10.3.3	Gas-oil-fired gas turbines.....	777
10.3.3.1	Energy efficiency	777
10.3.3.2	NO _x and CO emissions to air.....	778
10.3.3.3	SO _x and dust emissions to air	779
10.4	BAT CONCLUSIONS FOR THE COMBUSTION OF GASEOUS FUELS	780
10.4.1	BAT conclusions for the combustion of natural gas	780
10.4.1.1	Energy efficiency	780
10.4.1.2	NO _x , CO, NMVOC and CH ₄ emissions to air	781
10.4.2	BAT conclusions for the combustion of iron and steel process gases.....	786
10.4.2.1	Energy efficiency	786
10.4.2.2	NO _x and CO emissions to air.....	787
10.4.2.3	SO _x emissions to air.....	789
10.4.2.4	Dust emissions to air.....	790
10.4.3	BAT conclusions for the combustion of gaseous and/or liquid fuels on offshore platforms	791
10.5	BAT CONCLUSIONS FOR MULTI-FUEL-FIRED PLANTS.....	793
10.5.1	BAT conclusions for the combustion of process fuels from the chemical industry.....	793

10.5.1.1	General environmental performance.....	793
10.5.1.2	Energy efficiency.....	793
10.5.1.3	NO _x and CO emissions to air	794
10.5.1.4	SO _x , HCl and HF emissions to air.....	795
10.5.1.5	Dust and particulate-bound metal emissions to air	796
10.5.1.6	Emissions of volatile organic compounds and polychlorinated dibenzo-dioxins and -furans to air.....	797
10.6	BAT CONCLUSIONS FOR THE CO-INCINERATION OF WASTE.....	798
10.6.1	General environmental performance.....	798
10.6.2	Energy efficiency.....	799
10.6.3	NO _x and CO emissions to air	799
10.6.4	SO _x , HCl and HF emissions to air.....	800
10.6.5	Dust and particulate-bound metal emissions to air	800
10.6.6	Mercury emissions to air.....	800
10.6.7	Emissions of volatile organic compounds and polychlorinated dibenzo-dioxins and -furans to air	801
10.7	BAT CONCLUSIONS FOR GASIFICATION	802
10.7.1	Energy efficiency.....	802
10.7.2	NO _x and CO emissions to air	803
10.7.3	SO _x emissions to air	804
10.7.4	Dust, particulate-bound metal, ammonia and halogen emissions to air.....	804
10.8	DESCRIPTION OF TECHNIQUES.....	805
10.8.1	General techniques.....	805
10.8.2	Techniques to increase energy efficiency	805
10.8.3	Techniques to reduce emissions of NO _x and/or CO to air.....	806
10.8.4	Techniques to reduce emissions of SO _x , HCl and/or HF to air	808
10.8.5	Techniques to reduce emissions to air of dust, metals including mercury, and/or PCDD/F	809
10.8.6	Techniques to reduce emissions to water.....	810
11	EMERGING TECHNIQUES	813
11.1	COMMON PROCESSES AND TECHNIQUES FOR ENERGY GENERATION	813
11.1.1	High-temperature and -pressure super critical coal plant	813
11.2	COMMON TECHNICAL COMBUSTION PROCESSES.....	814
11.2.1	Techniques to reduce sulphur oxide emissions.....	814
11.2.1.1	Bubbling technology.....	814
11.2.2	Combined techniques to reduce sulphur oxide and nitrogen oxide emissions. 814	
11.2.2.1	Emerging gas/solid catalytic processes.....	814
11.2.2.2	Alkali injection	814
11.2.2.3	Wet scrubber with additives to achieve NO _x removal.....	814
11.2.3	Techniques to reduce metal emissions.....	815
11.2.3.1	Membrane filtration to reduce metals in scrubber waste water	815
11.2.4	CO ₂ capture processes.....	817
11.2.4.1	Post-combustion CO ₂ capture processes.....	818
11.2.4.1.1	Amine Process	818
11.2.4.1.2	Chilled Ammonia Process.....	821
11.2.4.1.3	Biocatalysis techniques to remove CO ₂ from flue-gases	823

11.2.4.2	Oxy-fuel combustion.....	824
11.2.4.3	Carbon Capture Readiness	826
11.2.4.3.1	Plant space and access requirements	827
11.2.4.3.2	Power plant CCR pre-investments	827
11.3	GASIFICATION / LIQUEFACTION / PYROLYSIS OF FUELS	829
11.3.1	IGCC (Integrated gasification combined cycle).....	834
11.3.2	Underground coal gasification	834
11.4	COMBUSTION OF SOLID FUELS.....	836
11.4.1	Combustion of coal and/or lignite.....	836
11.4.1.1	Pilot plant for pre-drying of lignite with low-temperature heat	836
11.4.1.2	Mercury emissions reduction	837
11.4.1.2.1	Coal beneficiation	837
11.4.1.2.2	Oxidation catalysts	838
11.4.1.2.3	Other novel control technologies.....	838
11.4.1.2.4	Photochemical oxidation process	839
11.4.1.3	Multi-pollutant control technologies	839
11.5	COMBUSTION OF LIQUID FUELS	841
11.5.1	Combustion of liquid petroleum commercial fuels in boilers / engines / turbines.....	841
11.5.1.1	Two-stage turbocharging for large internal combustion engines	841
11.5.2	Fuel cell applications.....	841
11.6	COMBUSTION OF GASEOUS FUELS	842
11.6.1	Combustion of natural gas in boilers / engines / turbines	842
11.6.1.1	Miller cycle and two-stage turbocharging in lean-burn gas engines	842
11.6.1.2	Methane slip development from gas-fired lean-burn engines	842
11.6.1.2.1	Oxidation catalyst.....	842
11.6.1.2.2	Recuperative oxidiser	843
11.6.1.3	Oxy-combustion.....	843
11.6.1.4	Catalytic combustion.....	843
11.6.1.5	Flameless combustion	844
11.6.1.6	Closed-loop steam cooling	846
11.6.1.7	Further development potential	846
11.6.1.8	Recuperative options.....	847
11.6.1.8.1	Intercooled recuperated gas turbine.....	847
11.6.1.8.2	HAT cycle	847
11.6.1.8.3	TOPHAT process	847
11.6.1.8.4	CHAT cycle.....	848
11.6.1.9	Advanced lean-burn approach for gas engines.....	848
11.6.2	Combustion of syngas in boilers / engines / turbines.....	848
11.6.2.1	Underground (coal gasification and) power generation	848
11.6.3	Fuel cell applications.....	848
12	CONCLUDING REMARKS AND RECOMMENDATIONS FOR FUTURE WORK.....	849
13	ANNEXES.....	865
13.1	ANNEX I - LIST OF EUROPEAN PLANTS THAT TOOK PART IN THE DATA COLLECTION EXERCISE IN 2012	865
13.2	ANNEX II - LIST OF WASTE CO-INCINERATED.....	911

13.3	ANNEX III - EXAMPLE TOOL FOR CONVERTING EMISSION LEVELS TO DIFFERENT AVERAGING PERIODS	913
13.4	ANNEX IV - MEASUREMENT UNCERTAINTIES REPORTED BY THE PLANTS THAT PARTICIPATED IN THE 2012 DATA COLLECTION	915
GLOSSARY.....		919
I.	ISO COUNTRY CODES	919
II.	MONETARY UNITS	920
III.	UNIT PREFIXES, NUMBER SEPARATORS AND NOTATIONS.....	920
IV.	UNITS AND MEASURES	921
V.	CHEMICAL ELEMENTS	923
VI.	ACRONYMS AND DEFINITIONS.....	924
REFERENCES.....		929

List of Tables

Table 1.1:	Area and population worldwide in 2011.....	1
Table 1.2:	Maximum electrical capacity in the EU-28 (MW) in 1990–2013	5
Table 1.3:	LCP in the EU (2013).....	7
Table 1.4:	Potential emission pathways by source type and substance.....	17
Table 1.5:	Air emissions of European large combustion plants (2013)	19
Table 1.6:	Fuel-bound nitrogen.....	21
Table 1.7:	List of water pollutants from LCPs.....	35
Table 2.1:	Heat and electricity generated by CHP plants in European countries in 2013.....	73
Table 2.2:	Typical efficiencies at the output shaft of gas turbines in relation to their thermal power ..	82
Table 2.3:	Commonly applicable efficiency improvement techniques at combustion plants	84
Table 2.4:	Examples of energetic and exergetic efficiencies of different types of combustion plants ..	87
Table 2.5:	Examples of effect of climatic conditions in Europe on the loss of efficiency of power plants.....	89
Table 2.6:	Typical energy consumption of secondary abatement techniques	90
Table 3.1:	Description of primary techniques for emission control.....	103
Table 3.2:	Indicative DeNO _x (secondary measures only) at large combustion plants in the EU-28 ..	109
Table 3.3:	Yearly emissions to water.....	123
Table 3.4:	Information for each technique described in this chapter	134
Table 3.5:	General performance of an ESP.....	141
Table 3.6:	General performance of bag filters	146
Table 3.7:	General performance of dust cleaning devices	148
Table 3.8:	General performance of wet scrubbers	152
Table 3.9:	Comparison between forced and natural oxidation.....	155
Table 3.10:	Performance of the wet lime/limestone scrubber technique for reducing sulphur oxide emissions	161
Table 3.11:	Potential performance improvement options	162
Table 3.12:	Performance of the seawater scrubber technique for reducing sulphur oxide emissions ..	165
Table 3.13:	Performance of the spray dry scrubber technique for reducing sulphur oxide emissions ..	173
Table 3.14:	Performance of the CFB dry scrubber technique for reducing sulphur oxide emissions ..	177
Table 3.15:	Performance of the duct sorbent injection technique for reducing sulphur oxide emissions	180
Table 3.16:	Performance of the furnace sorbent injection technique for reducing sulphur oxide emissions	186
Table 3.17:	Performance of the hybrid sorbent injection technique for reducing sulphur oxide emissions	188
Table 3.18:	Performance of the air staging technique for reducing nitrogen oxide emissions	194
Table 3.19:	Performance of the flue-gas recirculation technique for reducing nitrogen oxide emissions	197
Table 3.20:	Performance of the low-NO _x burner technique for reducing nitrogen oxide emissions....	203
Table 3.21:	Performance of the fuel staging (reburning) technique for reducing nitrogen oxide emissions	206
Table 3.22:	Trade-offs between control of NO _x emissions and efficiency.....	213
Table 3.23:	NO _x and CO emissions from applying water or steam injection to example gas turbines	217
Table 3.24:	Typical SCR efficiencies for different combustion processes (dependent on SCR design and injected reagent amount).....	226
Table 3.25:	Performance of the SCR technique for reducing nitrogen oxide emissions.....	226
Table 3.26:	Cost estimations for an SCR unit as a function of the flue-gas volume for a coal-fired boiler.....	229
Table 3.27:	Performance of the SNCR technique for reducing nitrogen oxide emissions.....	233
Table 3.28:	Performance of the activated carbon technique for reducing sulphur oxide/nitrogen oxide/mercury emissions	237
Table 3.29:	Performance of the WSA-SNO _x technique for reducing sulphur oxide/nitrogen oxides emissions	239
Table 3.30:	Main features of the plant taken as an example for the operating costs of the WSA-SNO _x technique in Table 3.31.....	239
Table 3.31:	Operating costs of the WSA-SNO _x technique at the example plant described in Table 3.30 operated 8 000 h/yr	240
Table 3.32:	Performance of the DeSONO _x technique for reducing sulphur oxide/nitrogen oxides emissions	241
Table 3.33:	Metal reduction efficiencies (%) achieved in a conventional pulverised-coal-fired plant.	244
Table 3.34:	Metal reduction efficiencies (%) achieved in a conventional pulverised-coal-fired plant.	246

Table 3.35:	Plant data of HCl scrubbers implemented at waste incineration facilities.....	252
Table 3.36:	Indicative comparison of cogeneration with separate power and heat generation	257
Table 3.37:	Achieved NO _x emissions and thermal efficiencies for conventional combustor turbines with modified fuel nozzles	261
Table 3.38:	Costs and weight for a Cheng steam injection cycle on a GE LM 2500 package	262
Table 3.39:	Environmental results of a combustion optimiser (Metso advanced process control solution)	269
Table 3.40:	Impact on plant efficiency of component refurbishments and upgrades	275
Table 3.41:	Techniques for the prevention and control of water pollution from plants operating flue-gas treatment with emissions to water.....	293
Table 3.42:	Plant emissions included in the plant codes shown in Figure 3.58 to Figure 3.72	295
Table 4.1:	Syngas compositions from fluidised bed and fixed-bed gasifiers (typical bituminous coal).....	318
Table 4.2:	Syngas compositions from entrained-flow coal gasification processes (typical bituminous coal).....	320
Table 4.3:	Syngas compositions for air-blown KBR and MHI gasification processes.....	320
Table 4.4:	Typical syngas compositions for BFB and CFB biomass gasifiers (range)	326
Table 4.5:	General information on efficiency and emissions to air of European IGCC plants	330
Table 4.6:	Comparison of the boiler gas emission measurement results from 100 % coal firing (1997) and from co-firing of gasifier gas and coal (2001)	331
Table 4.7:	Emission per MWh produced (heat and electricity) over 2007–2012	331
Table 4.8:	Waste water emissions from the WAC Buggenum IGCC power plant, the Netherlands...334	
Table 4.9:	Waste water emissions from the ELCOGAS IGCC plant, Puertollano, Spain.....334	
Table 4.10:	Solid by-products, residues and waste from the WAC Buggenum IGCC power plant, the Netherlands	335
Table 4.11:	Solid by-products, residues and waste from the ELCOGAS IGCC plant, Puertollano, Spain.....	336
Table 4.12:	Solid by-products, residues and waste from the Kymijärvi I plant, Lahti, Finland	336
Table 4.13:	Consumption data from the WAC Buggenum IGCC power plant, the Netherlands	337
Table 4.14:	Consumption data from the ELCOGAS IGCC plant, Puertollano, Spain	337
Table 4.15:	Consumption data from the Kymijärvi I plant, Lahti, Finland	337
Table 4.16:	Consumption levels per MWh produced (heat and electricity) over 2007–2012 for the Skive CHP plant.....	337
Table 4.17:	Data of the Tampa IGCC power plant (Florida, US)	341
Table 4.18:	Data of the Nuon IGCC power plant in Buggenum (the Netherlands).....	341
Table 4.19:	Data of the Wabash River IGCC power plant (Indiana, US)	341
Table 4.20:	Data of the IGCC power plant project in Nakoso (Japan).....	342
Table 4.21:	Data of the Puertollano IGCC power plant (Spain).....	342
Table 4.22:	Data of Italian IGCC plants gasifying refinery residues	342
Table 5.1:	Indicative analyses of typical coals and lignites (general practice).....	362
Table 5.2:	Indicative concentrations of metals and trace elements in coals from different regions	363
Table 5.3:	Typical monitoring of fuel characteristics in European coal- and/or lignite-fired plants...364	
Table 5.4:	Types of mills using different coal qualities	366
Table 5.5:	Example mercury removal efficiency for US coal-fired plants fitted with different combinations of techniques	375
Table 5.6:	Examples of marketing and removal of residues from coal and lignite combustion.....	378
Table 5.7:	Output of German lignite in 2012 by region	380
Table 5.8:	Key characteristics of German lignite	380
Table 5.9:	Mercury content in coal from different origins	381
Table 5.10:	Typical design net electrical efficiencies (LHV) for different LCP technologies	384
Table 5.11:	Effect of the steam characteristics on design efficiencies for different combustion processes	384
Table 5.12:	Example of emissions (in concentration – yearly averages) to air from coal-fired combustion plants.....	387
Table 5.13:	Example of emissions (in concentration – yearly averages) to air from lignite-fired combustion plants.....	388
Table 5.14:	Level of NO _x emissions for existing plants without secondary techniques	389
Table 5.15:	Pathways of metals in three example coal-fired combustion plants	390
Table 5.16:	Metals content in flue-gases at stack level from example European plants	390
Table 5.17:	Mercury content in flue-gases at stack level from example European plants.....	391
Table 5.18:	Measured N ₂ O emission levels taken from different literature sources	392
Table 5.19:	N ₂ O emissions from example European circulating fluidised bed boilers	392

Table 5.20:	Example of HCl and HF emission levels from plants with and without secondary techniques	393
Table 5.21:	Example of dioxins and PAHs emission levels from the combustion of different fuels	393
Table 5.22:	Production of CCPs in the EU-15 in 2010.....	397
Table 5.23:	Metal content of coal and some coal combustion residues	399
Table 5.24:	Input and output of metals in some coal-fired combustion plants	399
Table 5.25:	General techniques to be considered for the control of diffuse emissions from the unloading, storage and handling of fuel and additives.....	401
Table 5.26:	Techniques to be considered for improving the general environmental performance of coal- and/or lignite-fired plants.....	404
Table 5.27:	General techniques to be considered to increase energy efficiency and fuel utilisation	407
Table 5.28:	General techniques to be considered to increase energy efficiency	409
Table 5.29:	Net design electrical efficiency (%) achieved by example power combustion plants in the EU	411
Table 5.30:	Net design total fuel utilisation (%) achieved by example CHP combustion plants in the EU	411
Table 5.31:	General techniques to be considered for the prevention and control of dust and metal emissions	413
Table 5.32:	Co-benefit removal of mercury by techniques applied for other pollutants.....	418
Table 5.33:	Example of capital costs for implementing a sorbent injection system for mercury reduction	426
Table 5.34:	Example US plants operating brominated activated carbon injection systems	427
Table 5.35:	Other specific techniques to consider for the prevention and control of gaseous mercury emissions	431
Table 5.36:	General techniques to consider for the prevention and control of SO _x , HCl and HF emissions	433
Table 5.37:	General primary techniques to consider for the prevention and control of NO _x and N ₂ O emissions	442
Table 5.38:	General secondary techniques to consider for the prevention and control of NO _x and N ₂ O emissions	444
Table 5.39:	Comparison of biomass fuels and milled peat with fossil fuels normally used in LCPs ...	460
Table 5.40:	Specific emissions to air from biomass- and/or peat-fired combustion plants.....	463
Table 5.41:	Composition of minerals/nutrients in ash from the combustion of a typical wood pellet..	465
Table 5.42:	Techniques to reduce diffuse/fugitive emissions to air.....	467
Table 5.43:	Techniques to improve the general environmental performance	469
Table 5.44:	Techniques to increase energy efficiency	471
Table 5.45:	Techniques for the prevention and control of NO _x , CO and N ₂ O emissions	474
Table 5.46:	Techniques for the prevention and control of SO _x , HCl and HF emissions	479
Table 5.47:	Techniques for the prevention and control of dust and metal emissions	486
Table 5.48:	Techniques for the prevention and control of mercury	490
Table 5.49:	Techniques for handling, reduction, and recycling or recovery of combustion residues ...	492
Table 6.1:	General characteristics of liquid fuels.....	503
Table 6.2:	Chemical properties of several typical heavy fuel oils	503
Table 6.3:	Properties of Orimulsion.....	504
Table 6.4:	Range of yearly emissions to air from HFO- and/or gas-oil- fired combustion plants	505
Table 6.5:	Techniques for the prevention of emissions to soil and groundwater	507
Table 6.6:	Techniques to improve the general environmental performance of HFO- and/or gas oil fired boilers.....	509
Table 6.7:	Techniques to increase the energy efficiency of HFO- and/or gas-oil-fired boilers	511
Table 6.8:	Techniques for the prevention and control of NO _x and N ₂ O emissions from HFO- and/or gas-oil-fired boilers.....	514
Table 6.9:	Techniques for the prevention and control of SO _x emissions from HFO- and/or gas-oil-fired boilers.....	518
Table 6.10:	Techniques for the prevention and control of dust and particulate-bound metals emissions from HFO- and/or gas-oil-fired boilers.....	523
Table 6.11:	Techniques to increase the efficiency of HFO- and/or gas-oil-fired engines.....	527
Table 6.12:	Techniques for the prevention and control of NO _x and CO emissions from HFO-.....	529
Table 6.13:	Techniques for the prevention and control of SO _x emissions from HFO- and/or gas-oil-fired engines	534
Table 6.14:	Techniques for the prevention and control of dust and particulate-bound metals emissions from HFO- and/or gas-oil-fired engines.....	537
Table 6.15:	Techniques to increase the energy efficiency of gas-oil-fired gas turbines	540

Table 6.16:	Techniques for the prevention and control of NO _x and CO emissions from gas-oil-fired turbines.....	541
Table 6.17:	Techniques for the prevention and control of SO _x emissions from gas-oil-fired gas turbines.....	542
Table 6.18:	Techniques for the prevention and control of dust and particulate-bound metal emissions from gas-oil-fired gas turbines.....	543
Table 7.1:	Typical characteristics of NG fired in large combustion plants in Europe.....	546
Table 7.2:	Overview of typical ISO efficiencies of natural-gas-fired combustion units	552
Table 7.3:	Overview of operating energy efficiencies (yearly averages) of European natural-gas-fired combustion units.....	553
Table 7.4:	Calculated specific NO _x emissions with emission levels of 50 mg/Nm ³	559
Table 7.5:	Example of emissions to air from natural-gas-fired turbines in 2010	561
Table 7.6:	Examples of NO _x emissions for steady-state full engine load (15 % O ₂)	562
Table 7.7:	Example emissions of NMVOC, CO and CH ₄ reported by European natural-gas-fired engines (15 % O ₂)	563
Table 7.8:	Example of emissions to air from natural gas fired-boilers in 2010.....	564
Table 7.9:	General techniques to increase the energy efficiency of natural-gas-fired boilers, gas turbines and engines	567
Table 7.10:	General techniques for the prevention and control of NO _x and CO emissions from natural-gas-fired boilers	583
Table 7.11:	General techniques for the prevention and control of NO _x and CO emissions from natural-gas-fired turbines	588
Table 7.12:	Typical cost components for applying SCR at a gas turbine	590
Table 7.13:	Typical cost figures for applying SCR at a gas turbine	590
Table 7.14:	SCR retrofit costs for a 375 MW _e combined-cycle gas turbine.....	591
Table 7.15:	General techniques for the prevention and control of NO _x and unburnt carbon emissions from natural-gas-fired stationary engines.....	603
Table 7.16:	Emission levels of two gas-fired engine power plants equipped with SCR	605
Table 7.17:	Costs of installing SCR for gas engines operating 4 000 h/yr.....	607
Table 7.18:	Techniques for the prevention of emissions to soil	607
Table 7.19:	Overview of efficiencies of a biogas-fired gas turbine.....	608
Table 7.20:	Cleaned COG characteristics.....	612
Table 7.21:	Cleaned BF gas characteristics (average annual data).....	613
Table 7.22:	Cleaned BOF gas characteristics (average annual data).....	614
Table 7.23:	Comparison of the average LHV and Wobbe index values for BF gas, BOF gas and mixed BF + BOF gas.....	615
Table 7.24:	Composition of natural gas used in combustion plants firing iron and steel process fuels	616
Table 7.25:	Gas volumes, additional fuel tonnages and thermal inputs per 24 hours for combustion plants firing iron and steel process gases	619
Table 7.26:	An example composition of crude natural gas from an oilfield in the North Sea	651
Table 7.27:	Techniques to consider in the determination of BAT to increase energy efficiency for offshore installations	654
Table 7.28:	Techniques to consider in the determination of BAT to prevent and / or reduce NO _x and CO emissions for offshore installations	656
Table 8.1:	Ranges of reported emissions to air from boilers firing process fuels from the chemical industry.....	671
Table 8.2:	Techniques for the prevention and control of NO _x emissions.....	675
Table 9.1:	Example of coal/lignite and some typical sewage sludge compositions	693
Table 9.2:	Example compositions of waste wood types used in LCPs.....	694
Table 9.3:	Variation of impurities in different wood – waste mixtures.....	694
Table 9.4:	Experience with waste co-incineration in some LCPs in some EU Member States.....	696
Table 9.5:	Effect of co-incineration on combustion residues (dry sorption residue).....	704
Table 9.6:	Effect of co-incineration on combustion residues (coarse ash)	704
Table 9.7:	General techniques for the storage and handling of waste to be co-incinerated.....	707
Table 9.8:	General techniques for the pretreatment of waste to be co-incinerated.....	709
Table 9.9:	General techniques to introduce waste into the combustion process.....	712
Table 9.10:	General techniques for the prevention and control of emissions to air from waste co-incineration in combustion plants.....	713
Table 9.11:	Specific techniques for the prevention and control of emissions to air from waste co-incineration in combustion plants.....	714
Table 9.12:	Co-incineration degree and achieved HCl emissions in well-performing coal- and/or lignite-fired plants of more than 100 MW _{th} (see Figure 5.34).....	716

Table 9.13:	Co-incineration degree and achieved annual average HF emissions in well-performing coal- and/or lignite-fired plants of more than 100 MW _{th} (see Figure 5.35)	717
Table 9.14:	General techniques to reduce the impact of waste co-incineration on the residues generated.....	726
Table 10.1:	BAT-AELs for direct discharges to a receiving water body from flue-gas treatment	752
Table 10.2:	BAT-associated energy efficiency levels (BAT-AEELs) for coal and/or lignite combustion.....	756
Table 10.3:	BAT-associated emission levels (BAT-AELs) for NO _x emissions to air from the combustion of coal and/or lignite	758
Table 10.4:	BAT-associated emission levels (BAT-AELs) for SO ₂ emissions to air from the combustion of coal and/or lignite	760
Table 10.5:	BAT-associated emission levels (BAT-AELs) for HCl and HF emissions to air from the combustion of coal and/or lignite	761
Table 10.6:	BAT-associated emission levels (BAT-AELs) for dust emissions to air from the combustion of coal and/or lignite	761
Table 10.7:	BAT-associated emission levels (BAT-AELs) for mercury emissions to air from the combustion of coal and lignite.....	763
Table 10.8:	BAT-associated energy efficiency levels (BAT-AEELs) for the combustion of solid biomass and/or peat	763
Table 10.9:	BAT-associated emission levels (BAT-AELs) for NO _x emissions to air from the combustion of solid biomass and/or peat.....	764
Table 10.10:	BAT-associated emission levels (BAT-AELs) for SO ₂ emissions to air from the combustion of solid biomass and/or peat.....	766
Table 10.11:	BAT-associated emission levels (BAT-AELs) for HCl and HF emissions to air from the combustion of solid biomass and/or peat.....	766
Table 10.12:	BAT-associated emission levels (BAT-AELs) for dust emissions to air from the combustion of solid biomass and/or peat.....	767
Table 10.13:	BAT-associated energy efficiency levels (BAT-AEELs) for HFO and/or gas oil combustion in boilers.....	769
Table 10.14:	BAT-associated emission levels (BAT-AELs) for NO _x emissions to air from the combustion of HFO and/or gas oil in boilers.....	771
Table 10.15:	BAT-associated emission levels (BAT-AELs) for SO ₂ emissions to air from the combustion of HFO and/or gas oil in boilers.....	772
Table 10.16:	BAT-associated emission levels (BAT-AELs) for dust emissions to air from the combustion of HFO and/or gas oil in boilers.....	773
Table 10.17:	BAT-associated energy efficiency levels (BAT-AEELs) for the combustion of HFO and/or gas oil in reciprocating engines	774
Table 10.18:	BAT-associated emission levels (BAT-AELs) for NO _x emissions to air from the combustion of HFO and/or gas oil in reciprocating engines.....	775
Table 10.19:	BAT-associated emission levels (BAT-AELs) for SO ₂ emissions to air from the combustion of HFO and/or gas oil in reciprocating engines.....	776
Table 10.20:	BAT-associated emission levels (BAT-AELs) for dust emissions to air from the combustion of HFO and/or gas oil in reciprocating engines.....	777
Table 10.21:	BAT-associated energy efficiency levels (BAT-AEELs) for gas-oil-fired gas turbines....	778
Table 10.22:	BAT-associated emission levels for SO ₂ and dust emissions to air from the combustion of gas oil in gas turbines, including dual fuel gas turbines	779
Table 10.23:	BAT-associated energy efficiency levels (BAT-AEELs) for the combustion of natural gas.....	780
Table 10.24:	BAT-associated emission levels (BAT-AELs) for NO _x emissions to air from the combustion of natural gas in gas turbines	784
Table 10.25:	BAT-associated emission levels (BAT-AELs) for NO _x emissions to air from the combustion of natural gas in boilers and engines	785
Table 10.26:	BAT-associated emission levels (BAT-AELs) for formaldehyde and CH ₄ emissions to air from the combustion of natural gas in a spark-ignited lean-burn gas engine	786
Table 10.27:	BAT-associated energy efficiency levels (BAT-AEELs) for the combustion of iron and steel process gases in boilers	786
Table 10.28:	BAT-associated energy efficiency levels (BAT-AEELs) for the combustion of iron and steel process gases in CCGTs.....	787
Table 10.29:	BAT-associated emission levels (BAT-AELs) for NO _x emissions to air from the combustion of 100 % iron and steel process gases	789
Table 10.30:	BAT-associated emission levels (BAT-AELs) for SO ₂ emissions to air from the combustion of 100 % iron and steel process gases	790

Table 10.31: BAT-associated emission levels (BAT-AELs) for dust emissions to air from the combustion of 100 % iron and steel process gases.....	790
Table 10.32: BAT-associated emission levels (BAT-AELs) for NO _x emissions to air from the combustion of gaseous fuels in open-cycle gas turbines on offshore platforms.....	792
Table 10.33: BAT-associated energy efficiency levels (BAT-AEELs) for the combustion of process fuels from the chemical industry in boilers	793
Table 10.34: BAT-associated emission levels (BAT-AELs) for NO _x emissions to air from the combustion of 100 % process fuels from the chemical industry in boilers	795
Table 10.35: BAT-associated emission levels (BAT-AELs) for SO ₂ emissions to air from the combustion of 100 % process fuels from the chemical industry in boilers	796
Table 10.36: BAT-associated emission levels (BAT-AELs) for HCl and HF emissions to air from the combustion of process fuels from the chemical industry in boilers	796
Table 10.37: BAT-associated emission levels (BAT-AELs) for dust emissions to air from the combustion of mixtures of gases and liquids composed of 100 % process fuels from the chemical industry in boilers	797
Table 10.38: BAT-associated emission levels (BAT-AELs) for PCDD/F and TVOC emissions to air from the combustion of 100 % process fuels from the chemical industry in boilers.....	797
Table 10.39: BAT-associated emission levels (BAT-AELs) for metal emissions to air from the co-incineration of waste with coal and/or lignite	800
Table 10.40: BAT-associated emission levels (BAT-AELs) for metal emissions to air from the co-incineration of waste with biomass and/or peat.....	800
Table 10.41: BAT-associated emission levels (BAT-AELs) for PCDD/F and TVOC emissions to air from the co-incineration of waste with biomass, peat, coal and/or lignite	801
Table 10.42: BAT-associated energy efficiency levels (BAT-AEELs) for gasification and IGCC units	802
Table 10.43: BAT-associated emission levels (BAT-AELs) for NO _x emissions to air from IGCC plants	803
Table 10.44: BAT-associated emission levels (BAT-AELs) for dust and particulate-bound metal emissions to air from IGCC plants	804
Table 11.1: Removal of heavy metals and other pollutants from scrubber waste water	816
Table 11.2: Economic parameters for an example SiC membrane ultrafiltration plant.....	816
Table 11.3: Gasification technologies	829
Table 12.1: Key milestones in the review of the BREF for Large Combustion Plants	849
Table 12.2: Dissenting views expressed.....	851
Table 13.1: List of European plants that took part in the data collection exercise in 2012	866
Table 13.2: Example of monthly average levels calculated using the NL/Eurelectric tool	914

List of Figures

Figure 1.1:	Population index worldwide (1995 = 100)	1
Figure 1.2:	World electricity generation from 1971 to 2012 by fuel (TWh).....	2
Figure 1.3:	World electricity generation fuel shares in 1973 and 2012.....	2
Figure 1.4:	World electricity generation from 1971 to 2012 by region (TWh).....	3
Figure 1.5:	Net electricity generation in the EU-28 in 2013 (% of total, based on GWh)	3
Figure 1.6:	Gross electricity generation by fuel (GWh) in the EU-28 in 1990–2013	4
Figure 1.7:	Fuel mix of electricity generated in the EU-28 in 2011	5
Figure 1.8:	Total net electricity consumption in the EU-28 (TWh) in 2011	6
Figure 1.9:	Location of Large Combustion Plants in Europe.....	8
Figure 1.10:	Electricity generation by fuel – EU-28 trends to 2050. EU Reference scenario 2013.....	9
Figure 1.11:	Fuel input for steam generation in DH and boilers – EU-28 trends to 2050.....	10
Figure 1.12:	Mechanical drive engines and turbines for gas transport and storage (2009).....	11
Figure 1.13:	Example of annualised abatement cost per unit generated as a function of load factor.....	15
Figure 1.14:	Example of annualised abatement cost per tonne of pollutant removed as a function of remaining economic life	15
Figure 1.15:	General flow diagram of a combustion plant and its associated operations	16
Figure 1.16:	Emissions of SO _x /SO ₂ to air by industry sector/activity in the EU-28 in 2014.....	20
Figure 1.17:	Emissions of NO _x /NO ₂ to air by industry sector/activity in the EU-28 in 2014.....	22
Figure 1.18:	Emissions of PM ₁₀ to air by industry sector/activity in the EU-28 in 2014.....	24
Figure 1.19:	Partitioning of metals during coal combustion	25
Figure 1.20:	Emissions of Hg to air by industry sector/activity in the EU-28 in 2014	26
Figure 1.21:	Emissions of CO to air by industry sector/activity in the EU-28 in 2014.....	27
Figure 1.22:	Emissions of CO ₂ to air by industry sector/activity in the EU-28 in 2014	28
Figure 1.23:	Emissions of N ₂ O to air by industry sector/activity in the EU-28 in 2014	29
Figure 1.24:	Emissions of SF ₆ to air by industry sector/activity in the EU-28 in 2014.....	29
Figure 1.25:	Emissions of CH ₄ to air by industry sector/activity in the EU-28 in 2014	30
Figure 1.26:	Emissions of chlorine and inorganic compounds (as HCl) to air by industry sector/activity in the EU-28 in 2014.....	31
Figure 1.27:	Emissions of HF to air by industry sector/activity in the EU-28 in 2014	31
Figure 1.28:	Emissions of NMVOC to air by industry sector/activity in the EU-28 in 2014	33
Figure 1.29:	Effluents from fossil-fuel-fired large combustion plants.....	34
Figure 2.1:	Different coal burner configurations (main systems applied).....	45
Figure 2.2:	Tangential-fired combustion chamber	46
Figure 2.3:	Heavy fuel oil boiler	47
Figure 2.4:	Schematic of the bubbling fluidised bed boiler and the circulating fluidised bed boiler	48
Figure 2.5:	BFBC boiler (left) and CFBC boiler (right) schemes	50
Figure 2.6:	CFBC plant for high efficiency (Lagisza, 966 MWth, 361/306 kg/s, 275/50 bar, 560/580°C)¶	51
Figure 2.7:	CFBC plant for low-quality lignite (Turow, 3 x 557 MWth, 195/181 kg/s, 170/39 bar, 568/568 °C)	51
Figure 2.8:	Schematic drawing of a bubbling bed PFBC system.....	52
Figure 2.9:	Travelling grate firing for coal combustion	54
Figure 2.10:	Spreader stoker grate firing for solid fuels	55
Figure 2.11:	Natural gas-fired engine	58
Figure 2.12:	Heavy-duty gas turbine electricity-generating units from different manufacturers	59
Figure 2.13:	Scheme of a gas turbine process with sequential combustion	60
Figure 2.14:	Combined cycle power plant cogeneration principle 1+1 system.....	61
Figure 2.15:	Gas turbine (159 MW) with a silo combustion chamber	62
Figure 2.16:	Recently built gas turbine combined cycle power plant in Belgium.....	63
Figure 2.17:	Steam turbine of a coal-fired power plant.....	64
Figure 2.18:	Schematic of an ideal combustion Rankine steam cycle	65
Figure 2.19:	The natural circulation and once-through boiler concepts	66
Figure 2.20:	Gas turbine combined-cycle power plant	69
Figure 2.21:	CHP based on combined cycle where the steam turbine condenser cooling for the steam cycle is provided by a district heating network.....	70
Figure 2.22:	Duration curve of the district heating operation in the Helsinki region in 2003	72
Figure 2.23:	Main features of an oxygen-blown IGCC.....	77
Figure 2.24:	Ideal (Carnot) efficiency compared to the efficiencies actually achieved by the thermal energy generation techniques currently in use	79
Figure 2.25:	System boundaries for efficiency definition	81
Figure 2.26:	Relative deviation of electrical efficiency depending on load for a coal-fired power plant	82

Figure 2.27: Example demonstrating the methodology for calculating the exergetic efficiency	86
Figure 2.28: Improvements in the efficiency of power plants between 1993 and 2000	93
Figure 2.29: Peat, wood and coal handling system	96
Figure 2.30: European natural gas network in 2011	99
Figure 3.1: Overview of dust control devices	104
Figure 3.2: Overview of secondary techniques used to reduce sulphur oxide emissions	106
Figure 3.3: Overview of combustion modifications for reducing nitrogen oxide emissions	110
Figure 3.4: The activated carbon process	113
Figure 3.5: Mass balance of metals, fluoride and chloride in coal-fired combustion plants.....	114
Figure 3.6: FGD waste water treatment plant	120
Figure 3.7: Two-stage waste water treatment plant	121
Figure 3.8: Yearly sulphate concentrations in direct emissions to water – Comparison of plants with and without a wet abatement system for air pollutants.....	122
Figure 3.9: Yearly mercury concentrations in direct emissions to water – Comparison of plants with and without a wet abatement system for air pollutants.....	122
Figure 3.10: Impact of load factor variation on NO _x emissions at a GDF Suez natural gas combined- cycle plant, including five units of 385 MW _e	131
Figure 3.11: Example of NO _x (mg/Nm ³ , left) and O ₂ (% , right) (y axis) for different load factors (x axis) at a BFB boiler in Sweden	131
Figure 3.12: Continuous improvement in an EMS model	135
Figure 3.13: Typical schematic arrangement of an ESP	139
Figure 3.14: General arrangement of a bag filter (with one compartment in the cleaning cycle).....	143
Figure 3.15: Low-pressure pulse-jet bag filter.....	144
Figure 3.16: Typical flow diagram of a venturi system	150
Figure 3.17: Moving-bed scrubber	151
Figure 3.18: Schematic flow diagram of a lime/limestone wet scrubber FGD process	154
Figure 3.19: Different types of lime/limestone wet scrubbers	156
Figure 3.20: Different absorber types	158
Figure 3.21: Example of a co-current and counter-current wet FGD system	159
Figure 3.22: Seawater scrubbing process	164
Figure 3.23: The ammonia wet scrubber	168
Figure 3.24: Flowsheet of a spray dry scrubber process.....	170
Figure 3.25: Schematic of a CFB scrubber process flow.....	175
Figure 3.26: Duct sorbent injection	178
Figure 3.27: 'Modified dry FGD' process	180
Figure 3.28: Furnace sorbent injection	184
Figure 3.29: SO ₂ removal reactions in furnace sorbent injection	185
Figure 3.30: The relationship between NO _x , CO and excess air at various sections in a 150 MW _e lignite-fired boiler	190
Figure 3.31: NO _x formation in a tangentially coal-fired boiler (with and without a rotating opposed fired air (ROFA) system)	193
Figure 3.32: Flue-gas recirculation in a boiler.....	196
Figure 3.33: Comparison of conventional air-staged and advanced air-staged low-NO _x burners.....	200
Figure 3.34: Flue-gas recirculation low-NO _x burners	201
Figure 3.35: Fuel staging at the burner	202
Figure 3.36: The three combustion zones and relevant parameters in a reburning process	205
Figure 3.37: Comparison of coal, oil and natural gas as reburning fuel	206
Figure 3.38: Denitrification rate as a function of the reburning rate	207
Figure 3.39: Schematic of a DLN (premix) combustion chamber.....	209
Figure 3.40: NO _x reduction by steam or water injection.....	216
Figure 3.41: Different types of catalysts.....	220
Figure 3.42: Configuration of catalyst reactor.....	221
Figure 3.43: Existing configurations of SCR NO _x abatement techniques.....	222
Figure 3.44: Example of a high-dust SCR catalyst.....	223
Figure 3.45: SCR system applied to a stationary combustion engine.....	225
Figure 3.46: Investment costs for an SCR process at a combustion plant	228
Figure 3.47: The SNCR process	231
Figure 3.48: The activated carbon process	236
Figure 3.49: The WSA-SNO _x process.....	238
Figure 3.50: The DeSONO _x process	241
Figure 3.51: Influence of heat production on utilisation efficiency in a CHP plant	258
Figure 3.52: Principle sketch of the Cheng Steam Injection Cycle	260
Figure 3.53: NO _x and CO emission as a function of steam ratio.....	261

Figure 3.54:	Feed-water preheating	265
Figure 3.55:	Advanced control system applied at the Billerud AB Karlsborg plant, Sweden.....	268
Figure 3.56:	Schematic of a combined-cycle power plant with a heat recovery steam generator (HRSG).....	271
Figure 3.57:	Schematic of a topping cycle in a power plant	273
Figure 3.58:	Total suspended solids (TSS) emissions in direct discharges to a receiving water body ...	296
Figure 3.59:	Total organic carbon (TOC) emissions in direct discharges to a receiving water body.....	297
Figure 3.60:	Chemical oxygen demand (COD) emissions in direct discharges to a receiving water body	297
Figure 3.61:	Fluoride (F ⁻) emissions in direct discharges to a receiving water body	298
Figure 3.62:	Sulphate (SO ₄ ²⁻) emissions in direct discharges to a receiving water body	299
Figure 3.63:	Sulphide (S ²⁻) emissions in direct discharges to a receiving water body	300
Figure 3.64:	Sulphite (SO ₃ ²⁻) emissions in direct discharges to a receiving water body	300
Figure 3.65:	Arsenic (As) emissions in direct discharges to a receiving water body	301
Figure 3.66:	Cadmium (Cd) emissions in direct discharges to a receiving water body	301
Figure 3.67:	Chromium (Cr) emissions in direct discharges to a receiving water body	302
Figure 3.68:	Copper (Cu) emissions in direct discharges to a receiving water body	302
Figure 3.69:	Mercury (Hg) emissions in direct discharges to a receiving water body	303
Figure 3.70:	Nickel (Ni) emissions in direct discharges to a receiving water body	303
Figure 3.71:	Lead (Pb) emissions in direct discharges to a receiving water body	304
Figure 3.72:	Zinc (Zn) emissions in direct discharges to a receiving water body	304
Figure 4.1:	Block diagram and integration options for an IGCC plant	318
Figure 4.2:	General Electric single-stage entrained-flow gasifier	319
Figure 4.3:	Syngas composition as a function of the O ₂ to coal feed ratio.....	321
Figure 4.4:	Block diagram of the Tampa IGCC plant process	322
Figure 4.5:	Block diagram of the Nuon IGCC plant process	323
Figure 4.6:	Block diagram of the Wabash River IGCC repowering project	323
Figure 4.7:	Block diagram of the ELCOGAS IGCC plant process.....	324
Figure 4.8:	Foster and Wheeler atmospheric CFB gasifier	327
Figure 4.9:	ANDRITZ Carbona air-blown pressurised BFB gasifier.....	328
Figure 4.10:	Different principal options for CFB/BFB gasifier connections to boilers	329
Figure 4.11:	SO ₂ emissions of currently feasible coal-to-electricity technology options without CO ₂ capture	332
Figure 4.12:	NO _x emissions of currently feasible coal-to-electricity technology options without CO ₂ capture	332
Figure 4.13:	Particulate emissions of currently feasible coal-to-electricity technology options without CO ₂ capture.....	333
Figure 4.14:	Availability statistics for IGCC first-of-a-kind plants	343
Figure 4.15:	Kymijärvi CFB gasifier	346
Figure 4.16:	Vaskiluoto gasification plant	346
Figure 4.17:	The Skive CHP flowsheet.....	349
Figure 5.1:	Capacities of coal- and/or lignite-fired power plants in EU-27 countries in 2011.....	357
Figure 5.2:	Capacity, age and number of units of coal- and/or lignite-fired power plants in EU-27 countries in 2011	358
Figure 5.3:	Age and number of units of coal- and/or lignite-fired power plants in EU-27 countries in 2011	358
Figure 5.4:	Capacity-weighted average age of coal- and/or lignite-fired power plants in EU-27 countries.....	359
Figure 5.5:	Example large lignite-fired power plant with cooling tower discharge	360
Figure 5.6:	Influence of coal quality on the performance of the combustion plant.....	364
Figure 5.7:	Wet FGD process with a spray tower	370
Figure 5.8:	Closed gypsum storage facilities	376
Figure 5.9:	Coal in Europe in 2012 - Lignite production, coal production and imports	379
Figure 5.10:	Europe's most important lignite mining countries, 2000 (in million tonnes).....	380
Figure 5.11:	Sulphur and ash content in EU lignites ([wt-%], cross in medians)	381
Figure 5.12:	Efficiency impact of the power plant capacity (MW _{th}) based on design values	382
Figure 5.13:	Efficiency of coal-fired power plants in Europe in relation to the commissioning year based on design values.....	382
Figure 5.14:	Efficiency impact of the power plant capacity based on operating yearly average energy efficiency values	383
Figure 5.15:	Efficiency of coal- and/or lignite-fired power plants in Europe in relation to the commissioning year based on operating yearly average energy efficiency values	383
Figure 5.16:	Increased efficiency of a coal-fired power plant – individual measures.....	385

Figure 5.17: Increased efficiency of a coal-fired power plant – development of materials	385
Figure 5.18: Impact of the equivalent full load factor on N ₂ O emissions at Plant 387 (Lagisza, PL) ...	393
Figure 5.19: Annual production of CCPs in a 450 MW _e coal-fired power plant at 6 000 hours full load (total production of CCPs = 187 000 tonnes)	395
Figure 5.20: Production of CCPs in the EU-15 in 2010	396
Figure 5.21: Development of CCP production in the EU-15 from 1993 to 2010	396
Figure 5.22: Utilisation and disposal of CCPs in the EU-15 in 2010	397
Figure 5.23: Utilisation and disposal of CCPs in the EU-15 in 2010	398
Figure 5.24: Operating energy efficiencies of European coal- and/or lignite-fired plants of > 1 000 MW _{th}	410
Figure 5.25: Operating energy efficiencies from European coal- and/or lignite-fired plants of < 1 000 MW _{th}	411
Figure 5.26: Dust emissions from well-performing coal- and/or lignite-fired plants of less than 100 MW _{th}	414
Figure 5.27: Yearly average dust emissions from well-performing coal- and/or lignite-fired plants sized between 100 MW _{th} and 300 MW _{th}	415
Figure 5.28: Dust emissions from well-performing coal- and/or lignite-fired plants sized between 300 MW _{th} and 1 000 MW _{th}	416
Figure 5.29: Dust emissions from well-performing coal- and/or lignite-fired plants of more than 1 000 MW _{th}	417
Figure 5.30: Mercury emissions from well-performing coal fired plants	419
Figure 5.31: Mercury emissions from well-performing lignite-fired plants	420
Figure 5.32: SO ₂ emissions from well-performing coal- and/or lignite-fired combustion plants of more than 300 MW _{th} burning coal and/or non-indigenous lignite	436
Figure 5.33: SO ₂ emissions from example plants of more than 300 MW _{th} burning indigenous lignite ..	437
Figure 5.34: HCl emissions from well-performing coal- and/or lignite-fired plants of > 100 MW _{th}	438
Figure 5.35: HF emissions from well-performing coal- and/or lignite-fired plants of > 100 MW _{th}	439
Figure 5.36: Heat displacement around the FGD unit	440
Figure 5.37: NO _x emissions from well-performing pulverised coal boilers of more than 300 MW _{th}	445
Figure 5.38: NO _x emissions from well-performing pulverised lignite boilers and coal or lignite fluidised bed boilers of more than 300 MW _{th}	446
Figure 5.39: Water-cooled vibrating moving grate system with sloped grate boiler for biomass combustion	451
Figure 5.40: Straw-firing combustion plant	452
Figure 5.41: Biomass-fired circulating fluidised bed boiler	453
Figure 5.42: Fuel and bed material flow in a biomass-fired CFBC boiler	457
Figure 5.43: Example of the mass flow balance stream of a peat-fired CFBC boiler	461
Figure 5.44: Operating energy efficiencies of European biomass- and/or peat-fired combustion plants ..	470
Figure 5.45: NO _x emissions from well-performing biomass- and/or peat-fired plants of < 100 MW _{th} ..	476
Figure 5.46: NO _x emissions from well-performing biomass- and/or peat-fired plants between 100 MW _{th} and 300 MW _{th}	477
Figure 5.47: NO _x emissions from well-performing biomass- and/or peat-fired plants of ≥ 300 MW _{th} ..	477
Figure 5.48: SO ₂ emissions from well-performing biomass- and/or peat-fired plants of < 100 MW _{th} ..	481
Figure 5.49: SO ₂ emissions from well-performing biomass- and/or peat-fired plants between ≥ 100 MW _{th} and < 300 MW _{th}	482
Figure 5.50: SO ₂ emissions from well-performing biomass- and/or peat-fired plants of ≥ 300 MW _{th} ..	482
Figure 5.51: HCl emissions from well-performing biomass- and/or peat-fired plants of < 100 MW _{th} ..	483
Figure 5.52: HCl emissions from well-performing biomass- and/or peat-fired plants between ≥ 100 MW _{th} and < 300 MW _{th}	484
Figure 5.53: HF emissions from well-performing biomass- and/or peat-fired plants of < 100 MW _{th}	484
Figure 5.54: HF emissions from well-performing biomass- and/or peat-fired plants between ≥ 100 MW _{th} and < 300 MW _{th}	485
Figure 5.55: Dust emissions from well-performing biomass- and/or peat-fired plants of < 100 MW _{th} ..	487
Figure 5.56: Dust emissions from well-performing biomass- and/or peat-fired plants between 100 MW _{th} and 300 MW _{th}	488
Figure 5.57: Dust emissions from well-performing biomass- and/or peat-fired plants of ≥ 300 MW _{th} ..	488
Figure 5.58: Mercury emissions from well-performing biomass- and/or peat-fired plants	492
Figure 6.1: Operating energy efficiencies of European HFO- and/or gas-oil-fired combustion units ..	510
Figure 6.2: NO _x emissions from well-performing HFO- and/or gas-oil-fired boilers of < 100 MW _{th} ..	516
Figure 6.3: NO _x emissions from well-performing HFO- and/or gas-oil-fired boilers of ≥ 100 MW _{th} ..	517
Figure 6.4: SO ₂ emissions from well-performing HFO- and/or gas-oil-fired boilers of < 300 MW _{th} ..	521
Figure 6.5: SO ₂ emissions from well-performing HFO- and/or gas-oil-fired boilers of ≥ 300 MW _{th} ..	521
Figure 6.6: Dust emissions from well-performing HFO- and/or gas-oil-fired boilers of < 300 MW _{th} ..	524

Figure 6.7:	Dust emissions from well-performing HFO- and/or gas-oil-fired boilers of $\geq 300 \text{ MW}_{\text{th}}$	525
Figure 6.8:	Operating energy efficiencies of European HFO- and/or gas-oil-fired combustion engines	526
Figure 6.9:	Typical costs of SCR as a function of the NO_x reduction rate at a HFO-fired medium-speed diesel engine power plant	532
Figure 6.10:	Yearly NO_x , NH_3 , TVOC and CO emissions from HFO- and/or gas-oil-fired engines fitted with SCR and/or primary techniques	533
Figure 6.11:	SO_2 emissions from HFO- and/or gas-oil-fired engines reporting emission levels below 280 mg/Nm^3	536
Figure 6.12:	Dust emissions from well-performing HFO- and/or gas-oil-fired engines	538
Figure 6.13:	Configuration of an engine combustion plant fitted with SCR, recovery boiler, DSI and a bag filter	538
Figure 6.14:	Operating energy efficiencies of European gas-oil-fired gas turbines	539
Figure 6.15:	SO_2 emissions from well-performing gas-oil-fired gas turbines	542
Figure 6.16:	Dust emissions from well-performing gas-oil-fired gas turbines	543
Figure 7.1:	Physical properties of European and worldwide pipeline gas and LNG	546
Figure 7.2:	HRSG design and SCR installation	549
Figure 7.3:	SCR installation with vertical flow	550
Figure 7.4:	Grassmann diagram of a gas turbine with HRSG	552
Figure 7.5:	Net operating electrical efficiencies of CCGTs in Europe in 2010	554
Figure 7.6:	Net operating electrical efficiencies of CCGTs with supplementary firing in 2010	554
Figure 7.7:	Net operating electrical efficiencies of CCGTs without supplementary firing in 2010	555
Figure 7.8:	Net operating electrical efficiencies of CCGTs producing only power operated $\geq 4\,000$ hours in 2010	555
Figure 7.9:	Net operating electrical efficiencies of CCGTs producing only power operated $< 4\,000$ hours in 2010	556
Figure 7.10:	Net operating electrical efficiencies and total fuel utilisation in 2010 of natural-gas-fired boilers	557
Figure 7.11:	NO_x emissions from European natural-gas-fired turbines in 2010	557
Figure 7.12:	NO emissions as a function of the pressure with various combustion temperatures and a residence time in the reaction zone of 30 ms	558
Figure 7.13:	Example of CCGTs achieving low NO_x emissions and high operating electrical efficiencies	559
Figure 7.14:	NO_x emissions (yearly averages) from CCGTs fitted with supplementary firing at the HRSG level	560
Figure 7.15:	NO_x emissions (yearly averages) from CCGTs without supplementary firing at the HRSG level	561
Figure 7.16:	NO_x emissions (yearly averages) from European natural gas boilers in 2010	563
Figure 7.17:	Typical net operating electrical efficiencies in 2010 of European natural gas-fired open-cycle gas turbines	570
Figure 7.18:	Typical net operating energy efficiencies in 2010 of European natural-gas-fired combined-cycle gas turbines producing heat and power (plants from $50 \text{ MW}_{\text{th}}$ to $600 \text{ MW}_{\text{th}}$)	571
Figure 7.19:	Typical net operating energy efficiencies in 2010 of European natural-gas-fired combined-cycle gas turbines producing heat and power (plants of $> 600 \text{ MW}_{\text{th}}$)	572
Figure 7.20:	Typical net operating electrical efficiencies in 2010 of European natural-gas-fired combined-cycle gas turbines producing power only	573
Figure 7.21:	Typical operating net total fuel utilisation in 2010 of European natural-gas-fired boilers	574
Figure 7.22:	Typical net operating energy efficiencies in 2010 of European natural-gas-fired engines	574
Figure 7.23:	Effect of ambient intake temperature on the gas turbine thermal efficiency using evaporative and absorption chiller cooling	580
Figure 7.24:	NO_x emissions to air in 2010 from well-performing European boilers	586
Figure 7.25:	NO_x and CO emissions to air in 2010 from well-performing European CCGTs of $\geq 600 \text{ MW}_{\text{th}}$	592
Figure 7.26:	NO_x and CO emissions to air in 2010 from well-performing European CCGTs of $50\text{--}600 \text{ MW}_{\text{th}}$ with a net total fuel utilisation of $< 75\%$	593
Figure 7.27:	NO_x and CO emissions to air in 2010 from well-performing European CCGTs of $50\text{--}600 \text{ MW}_{\text{th}}$ with a net total fuel utilisation of $\geq 75\%$	593
Figure 7.28:	NO_x and CO emissions to air in 2010 from European open-cycle gas turbines with the exception of mechanical drive turbines	594
Figure 7.29:	NO_x and CO emissions to air in 2010 from well-performing European open-cycle gas turbines operated $\geq 500 \text{ h/yr}$ for mechanical drive turbines	595

Figure 7.30: NO _x and CO emissions to air in 2010 from well-performing European gas turbines operated < 500 h/yr	596
Figure 7.31: Schematic representation of the catalyst pollution control SCONO _x TM system.....	597
Figure 7.32: Example of energy flows in an integrated steelworks	610
Figure 7.33: Comparison of iron and steel process gases and natural gas	611
Figure 7.34: Hourly average data for the thermal input to a boiler using BF gas, COG and HFO over a period of three months.....	620
Figure 7.35: Hourly average inputs of BF gas and COG to a boiler over a two-week period	621
Figure 7.36: Hourly average thermal inputs of BF gas, COG and HFO to a boiler over a two-week period	622
Figure 7.37: Daily average thermal inputs of BFG, COG and BOF gas plus NG auxiliary fuel to a CCGT in 2010.....	623
Figure 7.38: Hourly average thermal inputs of BF gas, COG and HFO to a boiler over a two-week period	624
Figure 7.39: Hourly average emissions of dust, NO _x , SO _x and CO (reference 3 % O ₂) from a boiler fired on BF gas and COG with HFO addition as required over a two-week period.....	624
Figure 7.40: Half-hourly average thermal inputs of BFG and COG and total thermal input to the boiler over a 25-day period in November 2010.....	625
Figure 7.41: Half-hourly average emissions of NO _x and SO ₂ (reference 3 % O ₂) from a boiler fired on BFG and COG over a 25-day period in November 2010, as per figure 7.40	625
Figure 7.42: Daily average thermal inputs of I&S process gases plus NG and total thermal input to a CCGT over a 50-day period	626
Figure 7.43: Daily average emissions from a CCGT over a 50-day period, as per figure 7.42	626
Figure 7.44: Relationship between NO _x emissions and the relative thermal inputs to the boiler of BFG and COG using hourly average data over a three-month period.....	628
Figure 7.45: NO _x emissions (mg/Nm ³) against the gas flows (m ³ /h) for a boiler using three different base gas mixes	629
Figure 7.46: NO _x emissions and relative thermal input for a combination of three CCGTs combusting COG, using daily average data for 2010.....	630
Figure 7.47: Relationship between SO ₂ emissions and the relative thermal inputs to the boiler of BFG and COG using hourly average data over a three-month period.....	631
Figure 7.48: Relationship between SO ₂ emissions and COG inputs to 3 CCGTs using daily average data for 2010	632
Figure 7.49: Operating energy efficiencies of boilers firing iron and steel process gases in combination with other gaseous/liquid fuels for 2012	635
Figure 7.50: Operating energy efficiencies of CCGTs firing iron and steel process gases in combination with other gaseous fuels for 2012.....	635
Figure 7.51: NO _x emissions from well-performing gas boilers combusting iron and steel process gases	638
Figure 7.52: NO _x emissions from well-performing CCGTs combusting iron and steel process gases ..	639
Figure 7.53: Relationship between the NO _x emission and COG thermal input (%) for LCPs utilising iron and steel process gases.....	640
Figure 7.54: SO ₂ emissions from well-performing boilers combusting iron and steel process gases.....	643
Figure 7.55: Relationship between the daily average SO ₂ emission and COG thermal input (%) for boilers using iron and steel process gases (thermal input from auxiliary fuels < 5 %)	644
Figure 7.56: SO ₂ emissions from well-performing CCGTs combusting iron and steel process gases ...	645
Figure 7.57: Dust emissions from well-performing boilers combusting iron and steel process gases....	646
Figure 7.58: Dust emissions from well-performing CCGTs combusting iron and steel process gases ..	647
Figure 7.59: North Sea oil platform.....	648
Figure 8.1: Industrial CFB boiler with multi-inlet cyclone applied for multi-fuel firing.....	662
Figure 8.2: The effect of biomass multi-fuel firing on SO ₂ emissions	664
Figure 8.3: Utility boilers in chemical installations	668
Figure 8.4: NO _x emissions pattern as a function of the daily operation of a utility boiler not fitted with end-of-pipe measures (values are not taken from real installations)	672
Figure 8.5: NO _x concentration pattern in raw flue-gas as a function of the fuel blend at nominal load.....	673
Figure 8.6: NO _x and CO emissions from example boilers firing mixtures of gaseous and liquid process fuels from the chemical industry	677
Figure 8.7: NO _x and CO emissions from example boilers firing gaseous process fuels from the chemical industry	678
Figure 8.8: NO _x and CO emissions from example gas turbines firing process fuels from the chemical industry	678
Figure 8.9: Overfire air technique retrofitted in a boiler at a chemical installation	679

Figure 8.10:	SO ₂ , HCl and HF emissions from example plants firing mixtures of process gaseous and liquid fuels from the chemical industry	680
Figure 8.11:	Dust emissions from example plants firing mixtures of process gaseous and liquid fuels from the chemical industry	681
Figure 9.1:	Co-incineration combustion of coal and sewage sludge	688
Figure 9.2:	Internal grates in a pulverised coal-fired boiler	689
Figure 9.3:	Sb+As+Pb+Cr+Co+Cu+Mn+Ni+V emissions from well-performing coal- and/or lignite-fired plants of more than 300 MW _{th} , including plants co-incinerating waste.....	719
Figure 9.4:	Cd+Tl emissions from well-performing coal- and lignite-fired plants of more than 300 MW _{th} , including plants co-incinerating waste (averages over the year)	719
Figure 9.5:	TVOC emissions from well-performing coal- and lignite-fired plants, including plants co-incinerating waste	720
Figure 9.6:	PCDD/F emissions from well-performing coal- and/or lignite-fired plants of more than 300 MW _{th} , including plants co-incinerating waste	721
Figure 9.7:	Sb+As+Pb+Cr+Co+Cu+Mn+Ni+V emissions from well-performing biomass- and/or peat-fired plants, including plants co-incinerating waste.....	723
Figure 9.8:	Cd+Tl emissions from well-performing biomass- and/or peat-fired plants, including plants co-incinerating waste.....	724
Figure 9.9:	TVOC emissions from well-performing biomass- and/or peat-fired plants, including plants co-incinerating waste.....	725
Figure 9.10:	PCDD/F emissions from well-performing biomass- and/or peat-fired plants, including plants co-incinerating waste.....	726
Figure 11.1:	Amine Process using UCARSOL™ FGC 3000 (Alstom and Dow Chemical)	819
Figure 11.2:	Simplified flow diagram of a power plant with post-combustion CO ₂ capture	820
Figure 11.3:	Chilled Ammonia Process flow diagram	822
Figure 11.4:	Simplified flow diagram of an oxy-fuel power plant.....	824
Figure 11.5:	Pilot plant for lignite drying	836
Figure 11.6:	Presentation of the coal beneficiation K-Fuel process	837
Figure 11.7:	Typical picture of combustion obtained with a flameless burner	844
Figure 13.1:	Measurement uncertainties reported for NO _x emissions	915
Figure 13.2:	Measurement uncertainties reported for SO ₂ emissions	916
Figure 13.3:	Measurement uncertainties reported for dust emissions	917

SCOPE

This BREF for Large Combustion Plants concerns the following activities specified in Annex I to Directive 2010/75/EU:

- 1.1: Combustion of fuels in installations with a total rated thermal input of 50 MW or more, only when this activity takes place in combustion plants with a total rated thermal input of 50 MW or more.
- 1.4: Gasification of coal or other fuels in installations with a total rated thermal input of 20 MW or more, only when this activity is directly associated to a combustion plant.
- 5.2: Disposal or recovery of waste in waste co-incineration plants for non-hazardous waste with a capacity exceeding 3 tonnes per hour or for hazardous waste with a capacity exceeding 10 tonnes per day, only when this activity takes place in combustion plants covered under 1.1 above.

In particular, this document covers upstream and downstream activities directly associated with the aforementioned activities including the emission prevention and control techniques applied.

The fuels considered in this document are any solid, liquid and/or gaseous combustible material including:

- solid fuels (e.g. coal, lignite, peat);
- biomass (as defined in Article 3(31) of Directive 2010/75/EU);
- liquid fuels (e.g. heavy fuel oil and gas oil);
- gaseous fuels (e.g. natural gas, hydrogen-containing gas and syngas);
- industry-specific fuels (e.g. by-products from the chemical and iron and steel industries);
- waste except mixed municipal waste as defined in Article 3(39) and except other waste listed in Article 42(2)(a)(ii) and (iii) of Directive 2010/75/EU.

This document does not address the following:

- combustion of fuels in units with a rated thermal input of less than 15 MW;
- gasification of fuels, when not directly associated to the combustion of the resulting syngas;
- gasification of fuels and subsequent combustion of syngas when directly associated to the refining of mineral oil and gas;
- the upstream and downstream activities not directly associated to combustion or gasification activities;
- combustion in process furnaces or heaters;
- combustion in post-combustion plants;
- flaring;
- combustion in recovery boilers and total reduced sulphur burners within installations for the production of pulp and paper, as this is covered by the BREF for the production of pulp, paper and board;
- combustion of refinery fuels at the refinery site, as this is covered by the BAT conclusions for the refining of mineral oil and gas;
- disposal or recovery of waste in:
 - waste incineration plants (as defined in Article 3(40) of Directive 2010/75/EU),

- waste co-incineration plants where more than 40 % of the resulting heat release comes from hazardous waste,
- waste co-incineration plants combusting only wastes, except if these wastes are composed at least partially of biomass as defined in Article 3(31) (b) of Directive 2010/75/EU,

as this is covered by the BREF for waste incineration.

Other reference documents that could be relevant for the activities covered by this document are the following:

- Common Waste Water and Waste Gas Treatment/Management Systems in the Chemical Sector (CWW);
- Chemical BREF series (LVOC, etc.);
- Economics and Cross-Media Effects (ECM);
- Emissions from Storage (EFS);
- Energy Efficiency (ENE);
- Industrial Cooling Systems (ICS);
- Iron and Steel Production (IS);
- Monitoring of Emissions to Air and Water from IED installations (ROM);
- Production of Pulp, Paper and Board (PP);
- Refining of Mineral Oil and Gas (REF);
- Waste Incineration (WI);
- Waste Treatment (WT).

1 GENERAL INFORMATION ON THE STRUCTURE OF THE SECTOR

1.1 Industry overview

The world's population reached 6 974 million inhabitants in 2011, with a trend of growth that has been unbroken since 1995. See Table 1.1 and Figure 1.1.

Table 1.1: Area and population worldwide in 2011

Country	Land area (1 000 km ²)	Population (thousand)	Population density (inhabitants/km ²)
EU-28	4 381	506 781	116
China	9 597	1 344 100	140
Japan	378	127 817	338
Russia	17 098	142 961	8
United States	9 629	311 592	32
World	136 127	6 974 036	51

Source: [104, Eurostat 2011]

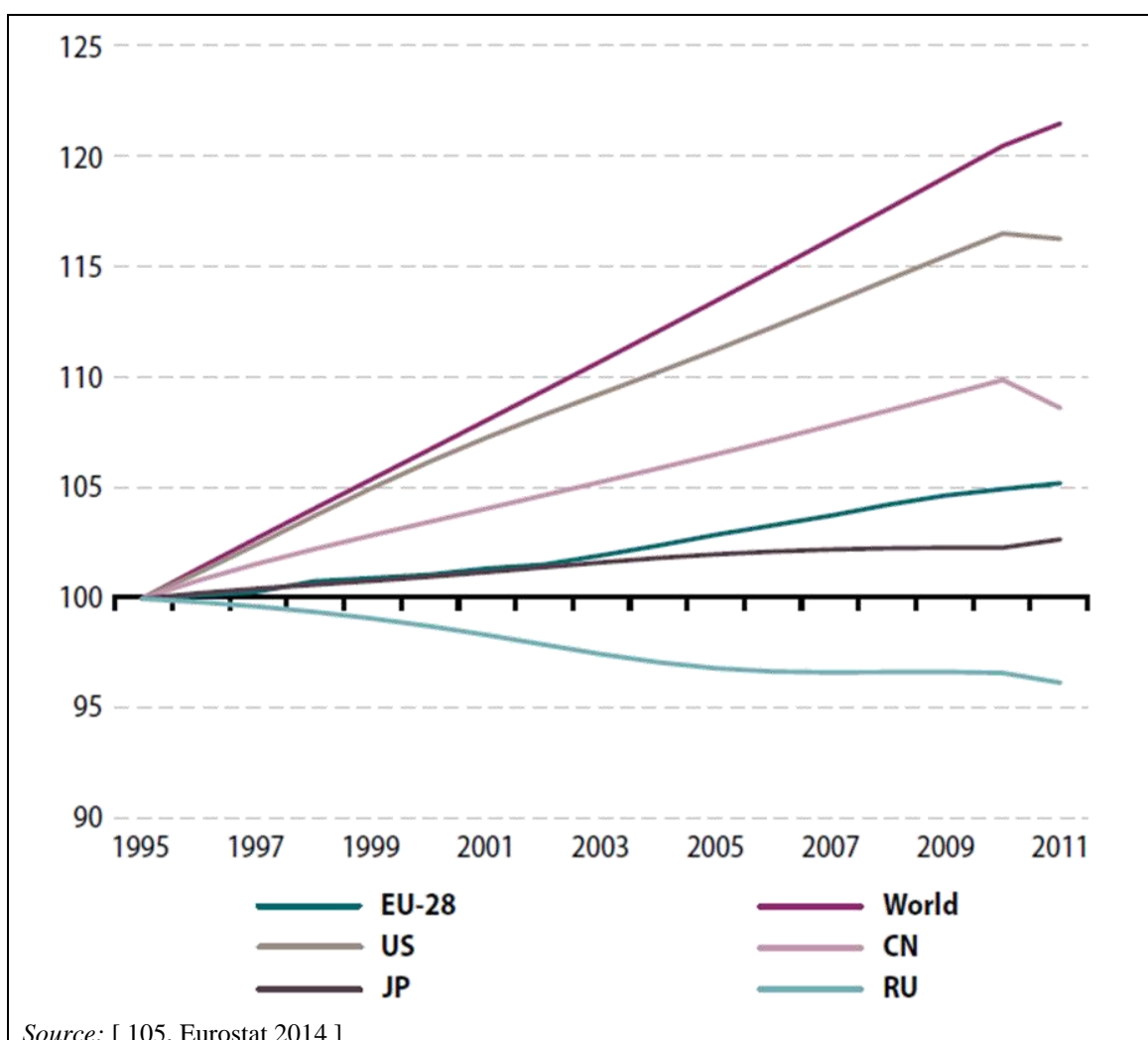
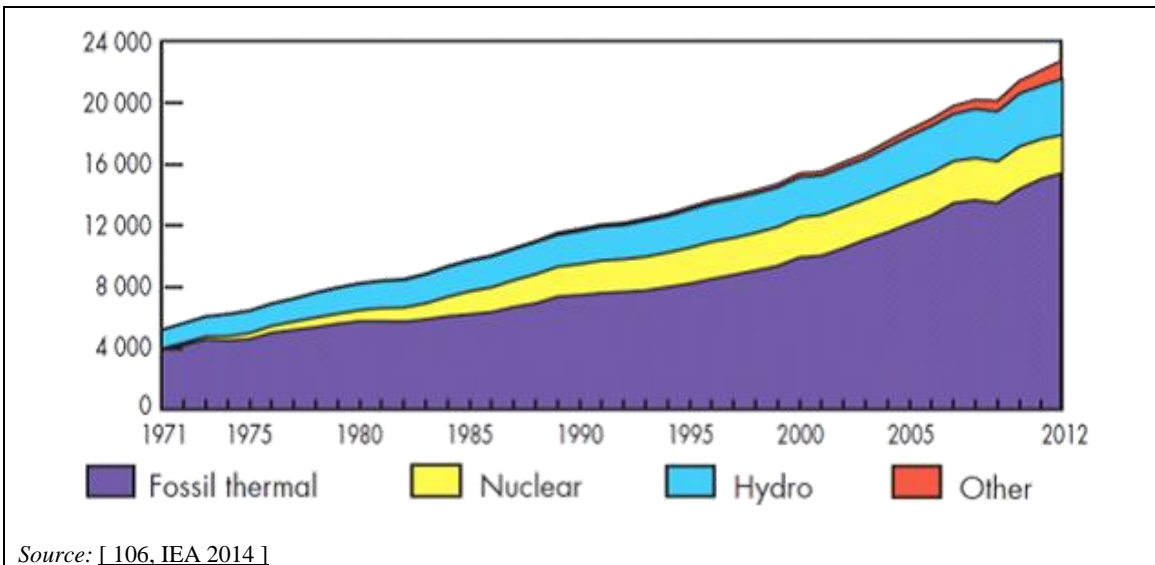

Figure 1.1: Population index worldwide (1995 = 100)

This population growth has also led to a continuous increase in the world electricity generation that may be observed by fuel type in Figure 1.2. Figure 1.3 shows the world electricity generation fuel shares in 1973 and 2012 with a total of 6 129 TWh and 22 668 TWh generated in the respective years.



Source: [106, IEA 2014]

Figure 1.2: World electricity generation from 1971 to 2012 by fuel (TWh)

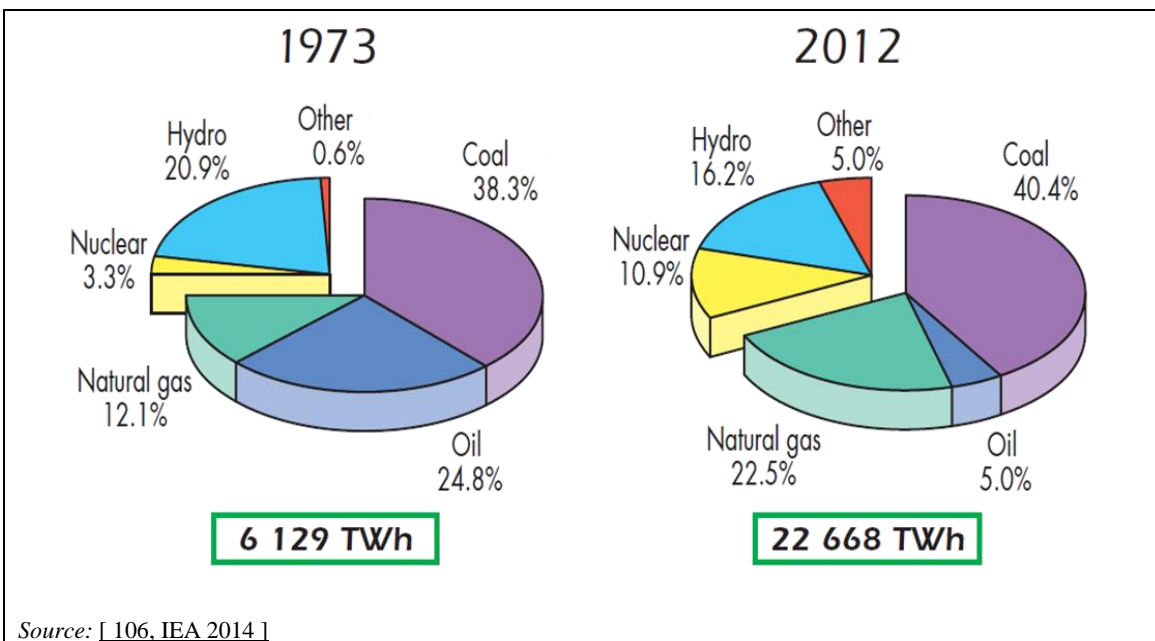

Source: [106, IEA 2014]

Figure 1.3: World electricity generation fuel shares in 1973 and 2012

World electricity generation from 1971 to 2012 by region is shown in Figure 1.4. The electricity generation in China is not included in the electricity generation of Asia.

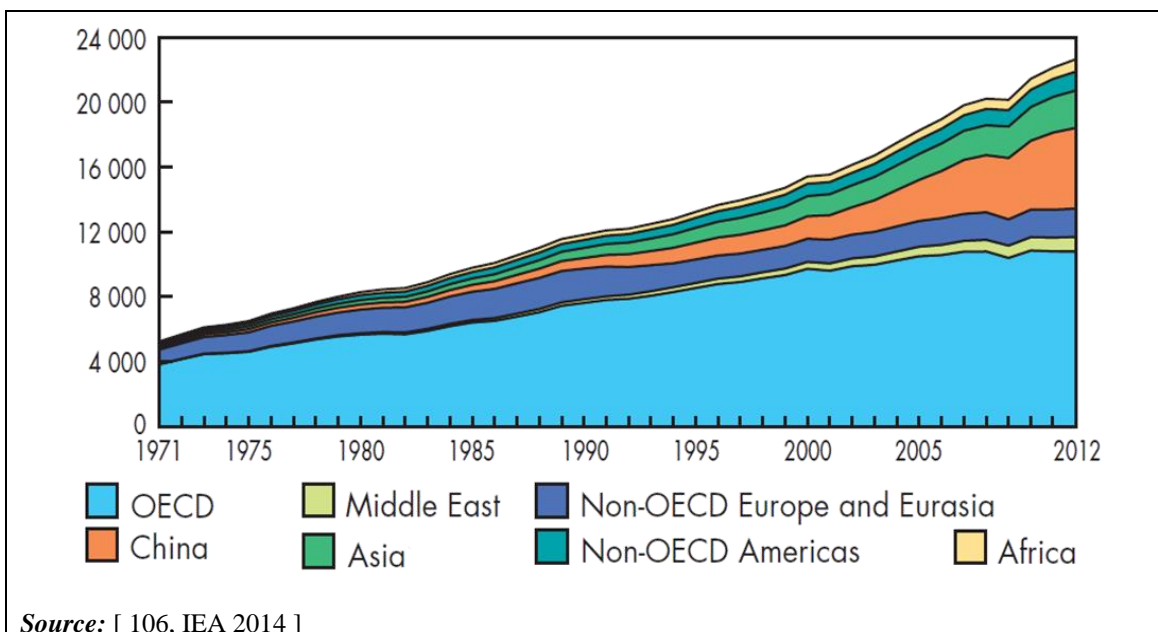

Figure 1.4: World electricity generation from 1971 to 2012 by region (TWh)

More than one quarter of the net electricity generated in the EU-28 in 2013 came from nuclear power plants (26.8 %), while almost double this share (49.8 %) came from power stations using combustible fuels (such as biomass, natural gas, coal and oil). Among the renewable energy sources shown in Figure 1.5, the highest share of net electricity generation in 2013 was from hydropower plants (12.8 %), followed by wind turbines (7.5 %) and solar power (2.7 %).

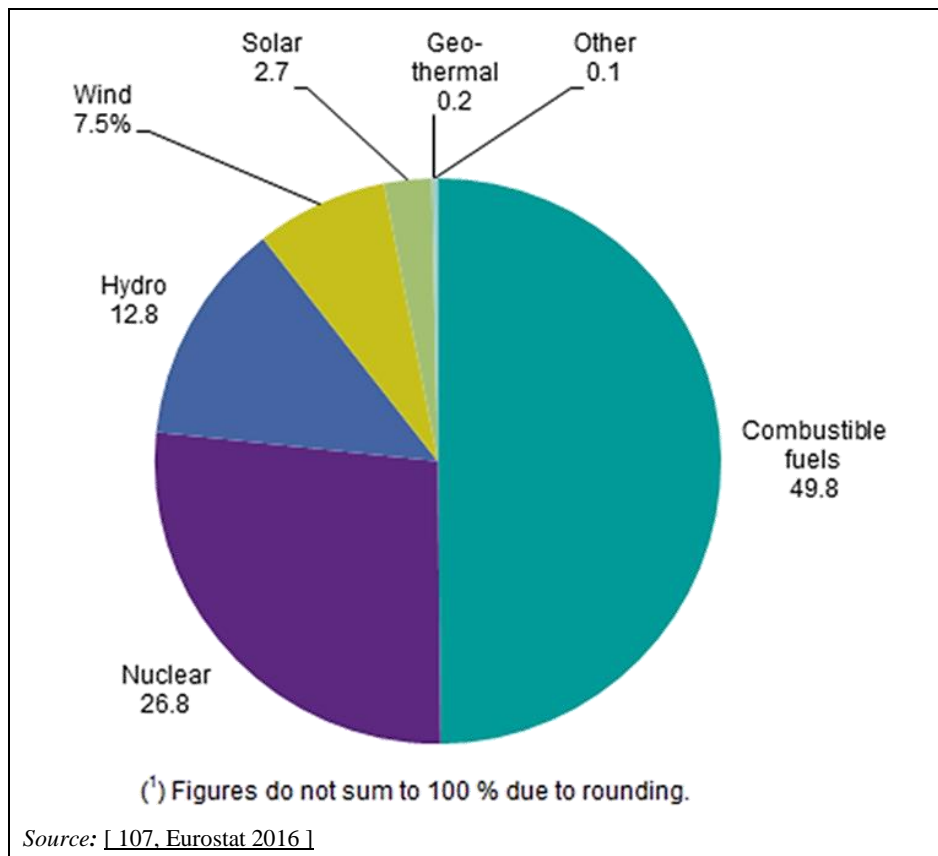

Figure 1.5: Net electricity generation in the EU-28 in 2013 (% of total, based on GWh)

Total gross electricity production in 2013 in the EU-28 was 3 262 TWh. The highest share of electricity in 2013 was produced in power plants using renewable sources of energy (27.3 %), followed by nuclear power plants (26.9 %), coal-fired power plants (26.7 %), gas (16.6 %), oil (1.9 %) and non-renewable waste (0.8 %). A time series for gross electricity production by major fuels is presented in Figure 1.6.

Since 1990 electricity generation from renewable energy sources has more than doubled in volume, and is the only source which also continued to grow after 2008. Electricity produced from gas shows the sharpest growth from 1992 until 2008, with an average growth rate of almost 9 % per year. In 2009 electricity generation from gas decreased followed by a short recovery in 2010 which changed into a steady decrease in 2011, 2012 and 2013. The trend in electricity production in nuclear power plants shows a moderate increase from 1999 until 2004, when a decrease started.

In 2013, 92.0 % of EU-28 electricity was produced by main activity producers, of which 77.0 % was from electricity-only power plants and 15.0 % from CHP plants. Nearly 58 % of electricity produced by main activity producers was produced from nuclear and solid fuels (29.2 % and 28.9 %, respectively), 27.0 % from renewable energy sources, 13.3 % from gas and 1.5 % from oil and petroleum products.

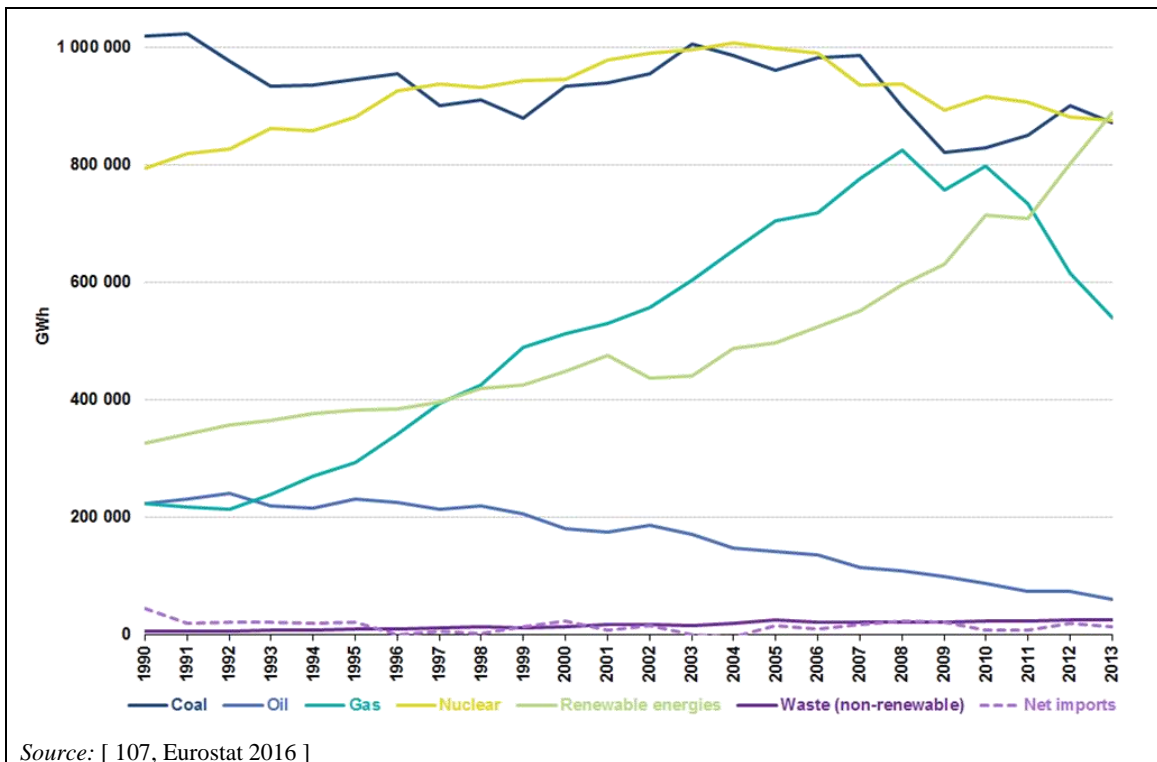

Figure 1.6: Gross electricity generation by fuel (GWh) in the EU-28 in 1990–2013

In 2013, the EU-28's maximum electrical capacity was about 958 500 MW. Half of the maximal capacity corresponds to combustible fuels. Table 1.2 shows the EU-28's maximum electrical capacity from 1990 to 2013 by type of fuel.

Table 1.2: Maximum electrical capacity in the EU-28 (MW) in 1990–2013

	1990	1995	2000	2005	2010	2011	2012	2013
Nuclear	121 070	128 435	136 637	134 994	131 731	132 087	123 183	122 971
Hydro	119 652	127 466	132 866	143 363	147 516	148 687	148 687	150 145
Geothermal	499	480	604	687	762	764	768	781
Solar	10	49	180	2 297	30 131	52 463	70 789	81 876
Tide, wave and ocean	240	240	241	240	241	241	243	243
Wind	471	2 447	12 711	40 568	84 624	94 290	105 421	117 936
Combustible Fuels	321 479	353 250	391 490	435 137	487 854	490 982	494 100	482 464
Industrial wastes	420	682	1 063	514	1 820	1 866	2 020	1 879
Municipal wastes	968	1 418	2 488	4 426	6 029	6 095	6 080	6 959
Solid biofuels	2 988	3 862	5 329	10 019	14 195	15 829	16 639	16 465
Biogases	260	509	1 243	3 088	5 934	7 031	8 279	8 660
Liquid biofuels	0	0	0	704	1 068	1 141	1 842	1 864
Other sources	10	142	229	905	883	2 162	2 044	2 111

Source: [108, Eurostat 2016]

In the European Union, all available types of energy sources are used for electric and thermal power generation. The type of fuel used for energy generation in each EU Member State (MS) is largely influenced by national fuel resources, such as the local or national availability of coal, lignite, natural gas, or oil. For example, in Greece and in parts of Germany and Poland, significant lignite resources are available for energy generation. In Finland and Ireland, for instance, peat is an important domestic energy source and, therefore, an important cornerstone of the national energy policy. In France, where nuclear power stations provide the majority of the nation's energy demand, the use of fossil fuel is mainly restricted to a small number of peak load plants. In Sweden and Finland, for instance, biomass is an important domestic energy source. The fuel mix of electricity generated in 2011 by each MS (%) is shown in Figure 1.7.

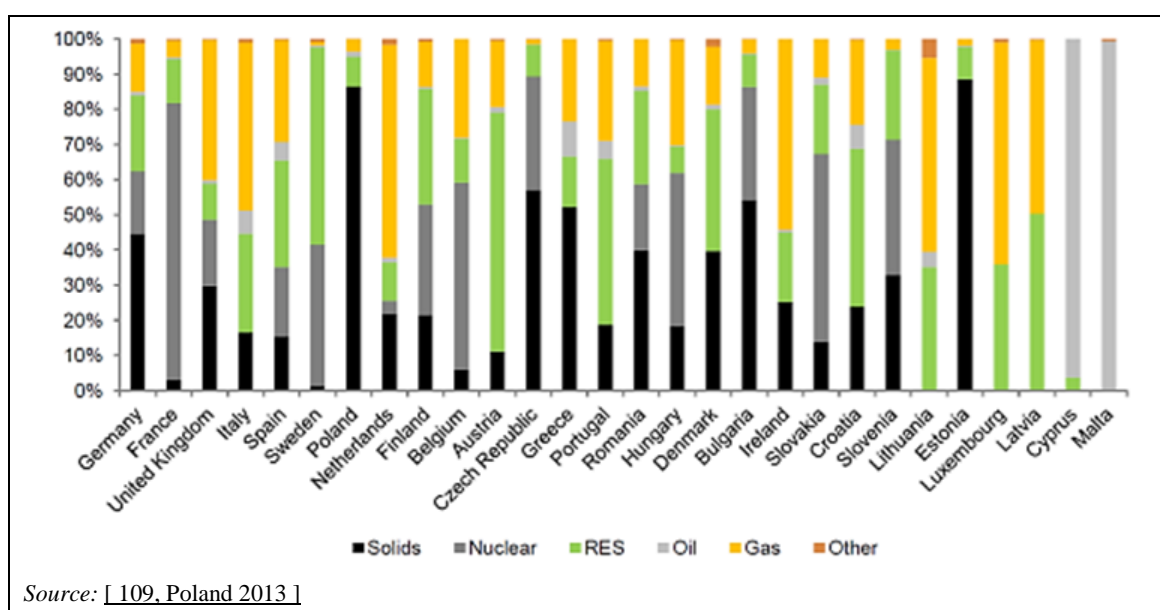
**Figure 1.7: Fuel mix of electricity generated in the EU-28 in 2011**

Combustion plants are used in the EU according to their demands and requirements, either as large utility plants or as industrial combustion plants that provide electricity, steam, or heat to industrial production processes. Plant loading can vary from part load up to full load, and their operating hours can also vary, from just a few hours of energy generation per year up to full-time operation. Increased power production from weather-dependent sources may change the operation pattern from full-time to part-time. Total net electricity consumption in the EU-28 (TWh) in 2011 is shown in Figure 1.8.

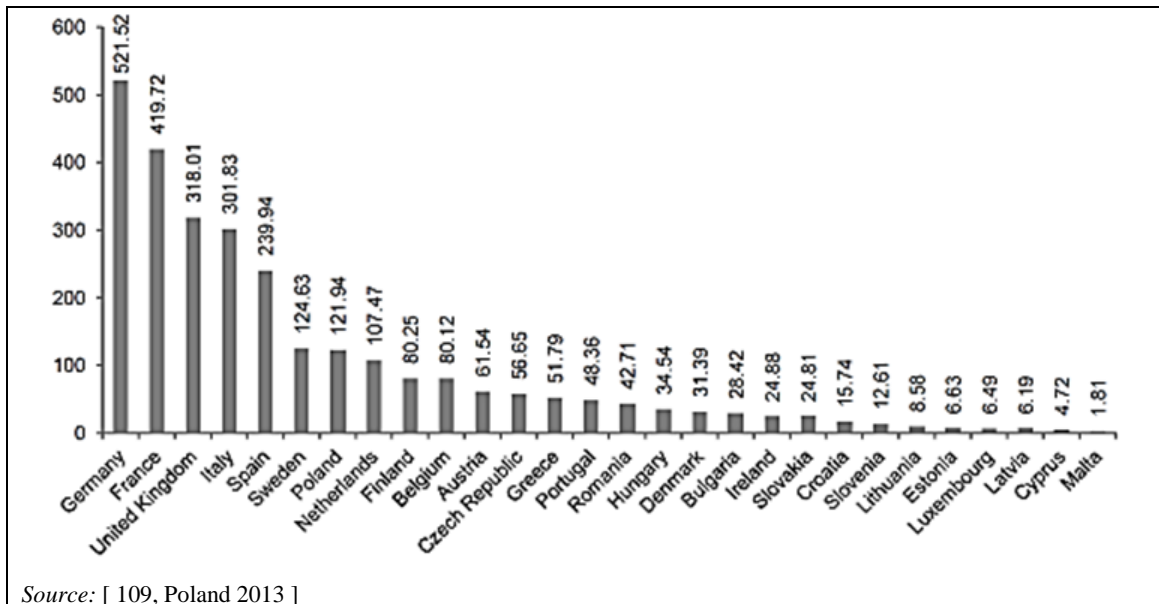

Figure 1.8: Total net electricity consumption in the EU-28 (TWh) in 2011

Since 2004, the EU Member States report emissions from Large Combustion Plants in accordance with Directive 2001/80/EC on the limitation of emissions of certain pollutants into the air from large combustion plants. The plant-by-plant data includes total annual emissions of SO₂, NO_x and dust and the total annual amount of energy input, expressed as net calorific value, broken down by five categories of fuel: biomass, other solid fuels, liquid fuels, natural gas, and other gases. Table 1.3 shows the number of non-refinery plants by Member State that reported emissions to air in 2013, the aggregated total rated thermal input and the fuel used. Emissions to air are given in Table 1.5.

Table 1.3: LCP in the EU (2013)

	Number of plants	MW _{th}	Biomass (TJ)	Other solid fuels (TJ)	Liquid fuels (TJ)	Natural gas (TJ)	Other gases (TJ)
AT	90	19 709	9 812	47 331	1 195	75 728	24 293
BE	86	20 367	36 553	29 460	3 556	124 245	25 469
BG	24	23 601	5 533	234 164	0	33 935	676
CY	16	3 864	0	0	32 534	0	0
CZ	101	43 639	10 588	504 010	3 690	22 218	34 076
DE	560	272 785	48 196	2 681 498	57 173	68 5006	239 077
DK	73	16 481	36 221	131 095	4 521	24 407	154
EE	20	10 300	7 020	125 652	643	6 110	5 970
EL	50	24 613	0	282 023	17 113	92 904	0
ES	144	77 686	5 517	408 664	68 303	216 257	55 993
FI	159	30 493	86 336	160 433	2 271	57 355	6 271
FR	235	79 595	22 456	256 303	52 297	136 131	52 485
HR	13	4 617	0	23 290	1 395	12 434	483
HU	42	17 665	17 132	75 074	753	47 257	5 129
IE	27	13 973	1 969	61 456	5 268	96 011	2
IT	342	136 366	19 704	425 569	39 777	732 406	134 531
LT	21	12 488	4 620	0	5 265	30 102	974
LU	1	730	0	0	0	7 218	0
LV	20	5 711	667	42	2	23 866	0
MT	9	1 745	0	0	21 603	0	0
NL	146	50 529	20 108	221 556	8 442	266 803	143 734
PL	96	104 409	81 946	1 446 819	6 909	33 630	33 531
PT	26	12 387	6 516	106 016	849	33 592	1 869
RO	85	36 459	128	205 722	1 752	98 273	278
SE	128	28 340	96 157	17 760	7 330	14 577	10 943
SI	16	4 653	1 009	55 791	132	1 950	0
SK	63	11 286	7 443	51 228	342	29 595	12 603
UK	248	152 905	83 805	1 137 287	10 249	765 457	48 500

Source: [113, EEA 2013]

Figure 1.9 shows the location of the large combustion plants in Europe (northern Sweden, northern Finland, the Canary Islands and other remote European islands are not represented on the map).



Figure 1.9: Location of Large Combustion Plants in Europe

The climate change, energy and air quality agenda has led to a restriction of emissions to air and to a strengthening of the legislation. In this context, the European Commission initiated several policies that will impact on the LCP sector as it is one of the major contributors to emissions of greenhouse gases and local air pollutants. These include:

- promoting renewable energy up to 2020 and beyond;
- strengthening and expanding the Emissions Trading System (EU ETS), which limits the amount of CO₂ that can be emitted by large industrial plants across the EU;
- promoting the development and safe use of carbon capture and storage (CCS);
- strengthening emission limits for SO₂ and NO_x and dust, through policy instruments such as Directive 2016/2284 on the reduction of national emissions of certain atmospheric pollutants (replacing the National Emissions Ceiling Directive);
- improving the energy efficiency footprint of installations and the network;
- Thematic Strategies on Air Pollution;
- Air Quality Standards, e.g. the Air Quality Directive 2008/50/EC.

This implies that many of the existing fossil-fuel-fired plants will gradually be replaced at a rate dependent on the rate of build of low-carbon plants. However, because of the high penetration of intermittent renewables (e.g. wind), some plants may be required in the future as back-up to the renewable portfolio and to maintain security of supply when other options, such as the greater use of interconnectors or the development of energy storage systems, cannot meet the demand.

It is clear therefore that the LCP sector is facing a major transformation as it evolves in response to substantial changes in the environmental agenda, whilst maintaining the other objective of delivering secure and affordable energy. [85, Eurelectric 2012]

The EU Reference scenario 2013 report [110, COM 2013] is an update and extension of the previous trend scenarios for the development of energy systems taking account of transport and GHG emissions developments, such as the 'European energy and transport - Trends to 2030' published in 2003 and its 2005, 2007 and 2009 updates. This report focuses on trend projections understood in the sense of a Reference scenario. Similar to the last Reference scenario update from 2009, this Reference scenario starts from the assumption that the legally binding GHG and RES targets for 2020 will be achieved and that the policies agreed at EU level by spring 2012 (notably on energy efficiency) as well as relevant adopted national policies will be implemented in the Member States. Figure 1.10 shows the electricity generation trend by fuel type in the EU-28 to 2050. Generation from solid fuels declines significantly throughout the projection period, in particular in the period 2030–50. Gas-fired generation slightly decreases until 2020, but increases thereafter, in 2050 reaching the same levels as in 2010.

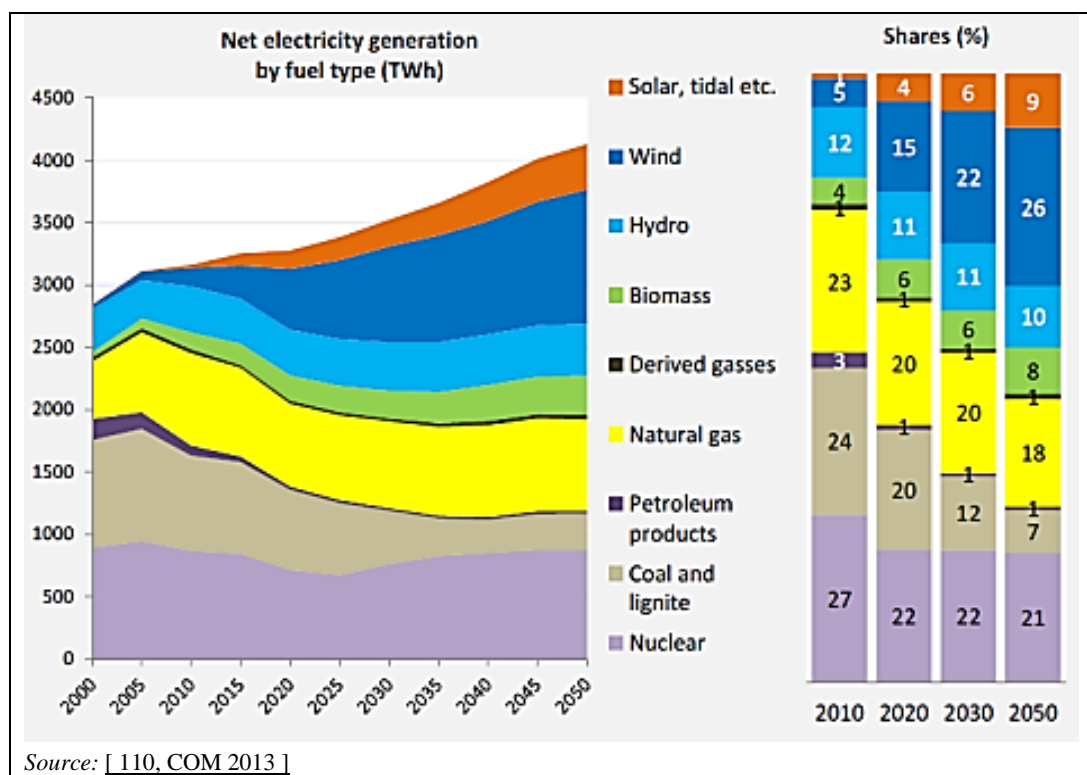

Figure 1.10: Electricity generation by fuel – EU-28 trends to 2050. EU Reference scenario 2013

The share of gross electricity produced by CHP plants reaches a level around 16 % throughout the period from 2020 until 2050, significantly up from 13 % in 2010. The role of cogeneration in steam and heat supply grows from 73 % in 2010 to 76 % in 2030 and 80 % in 2050. In terms of district heating fuel input, the share of solids and oil decreases considerably and the share of gas decreases as well but at a slower rate and only till 2030. Biomass is used increasingly, representing almost 50 % of fuel input in 2020 and 57 % in 2050 (in comparison to 26 % in

2010). Figure 1.11 shows the fuel input for steam generation in district heating (DH) and boilers.

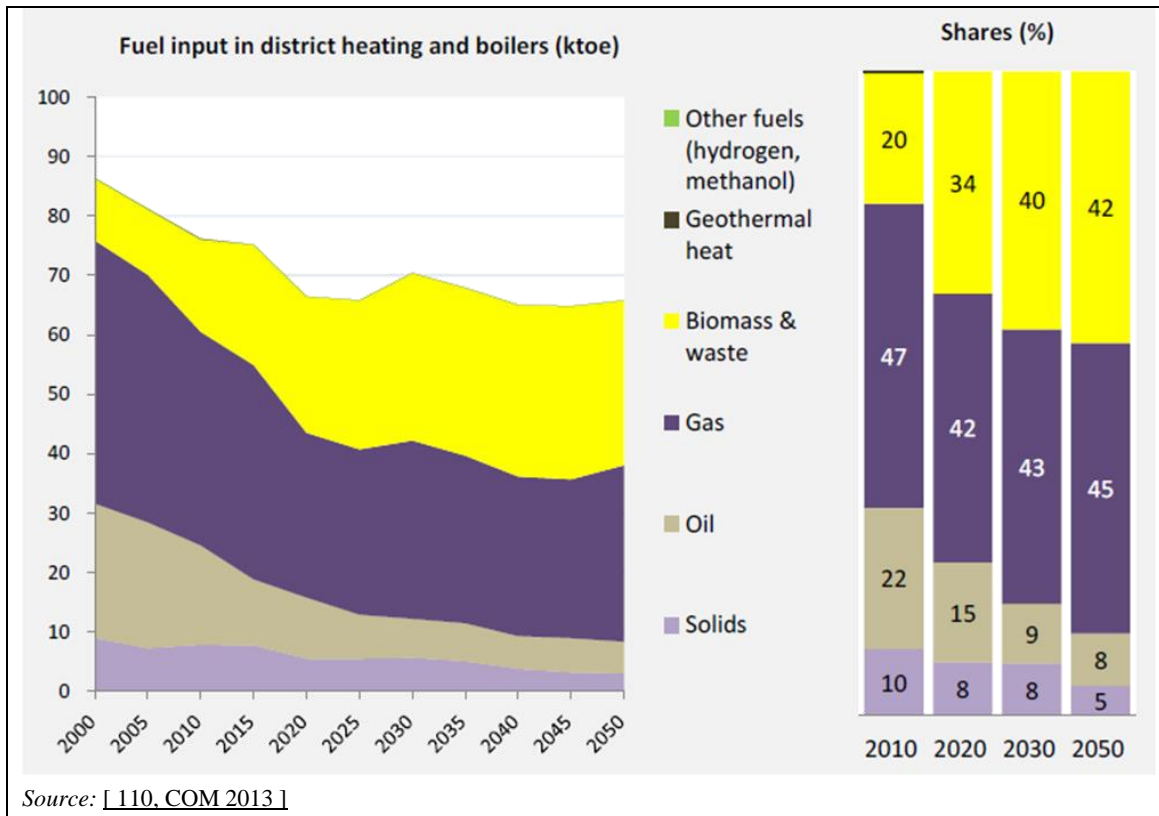

Figure 1.11: Fuel input for steam generation in DH and boilers – EU-28 trends to 2050

In the EU, the natural gas high-pressure grid in the 28 EU countries is 235 000 km long. The high-pressure grid delivers gas to a low-pressure distribution grid which is 1 649 400 km long. Compressor stations (167 compressor stations in total) are only in the high-pressure grid. One compressor station always consists of a minimum of 2 compressors (due to the required security of supply, there is always a redundant system) and a maximum of 12 individual compressor units. In total, 120 682 000 customers are connected to the gas grid. Since gas will only move when there is a pressure differential, gas compressors are required. By compressing the gas, the volume is reduced and the diameter of the pipelines can be reduced. The gas compressors are powered by gas turbines, piston-type gas engines and in some special circumstances by electric motors.

In a survey carried out in 2009 by Marcogaz, where 11 countries participated with a total of 32 engines and 515 gas turbines, representing a total capacity 19 103 MW, turbines and engines consumed 71 554 TJ of natural gas, which represents 93 % of the capacity for transport, as represented in Figure 1.12. [111, Marcogaz 2013]

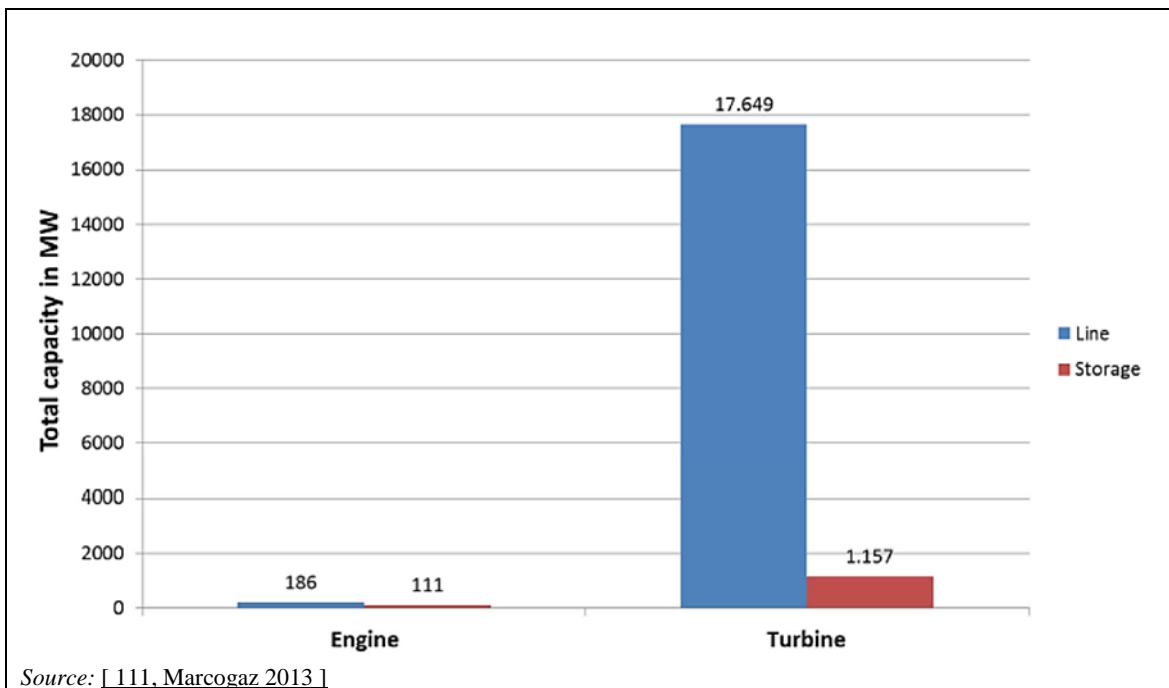

Figure 1.12: Mechanical drive engines and turbines for gas transport and storage (2009)

1.2 Economic situation

The opening up of electricity markets is an ongoing worldwide process. The principal objective is to increase competition across the sector and thereby encourage the reduction of generation, transmission, distribution and supply costs to the benefit of both industrial and domestic consumers.

In parallel with the liberalisation of the electricity market, there is a move towards the use of economic instruments to achieve national and international energy and environmental policy objectives. These instruments take various forms including taxes, incentives and market-based trading opportunities.

In 1996, the European Union introduced the Internal Electricity Market (IEM) Directive (96/92/EC), repealed by Directive 2009/72/2009, which required MS to open up up to 25 % of their markets to competition, although they remained free to take their market opening-up process even further. The degree of actual market opening varies throughout the EU, from a full open market in some countries to a partially open market in others.

The opening up of markets to competition can have a significant impact on a range of factors affecting the operation and regulation of LCPs, and which may be taken into account in determining the appropriateness of particular techniques to reduce emissions to air, water and soil. The need for some plants to manage specific customer requirements including auxiliary services, such as maintaining voltage and frequency, leads to load following, peak load production and black start capability. These factors include, but are not limited to, the following:

- Security of the energy supply. This can affect the levels of excess capacity in a system and the extent of fuel diversity, although the capacity is itself influenced by the need for spinning reserve and the availability of fuel storage.
- Cost and availability of fuel.
- Cost and availability of allowances provided under the EU Emissions Trading System (ETS).
- The level of system security that is required by any given market can significantly influence factors such as the redundancy in plant design, with a direct influence on investment costs and the level of electricity price required to pay back investment.
- The impact of the market shape (i.e. load duration curves), which, together with factors such as the marginal cost of generation, can influence the level of utilisation of particular types of plant, availability requirements and the level of excess capacity.
- Remuneration structures within particular markets, including whether they operate contract markets, balancing markets, trading via an electricity pool, capacity payments, etc.
- The level of the forward price within the market and the price structure in relation to plant utilisation and generation costs, which may influence the ability of a given market to pay back investments.
- The extent to which tariffs in a particular market are fixed to control the supply or consumption of electricity produced by a given technique or sourced from a particular fuel, so as to support the energy policy requirements of individual Member States. Other instruments are also used by the Member States to achieve these objectives, including carbon, energy, and pollutant taxes.
- The capacity from renewable sources benefitting from preferential feed-in tariffs.
- The need for a particular plant to manage specific customer interface requirements, including ancillary services such as maintaining system voltage and frequency, load following and load structure, black start capability and the specific need to meet local grid constraints, all of which can have a marked impact on the operational characteristics of such a plant.

- The interaction of connected markets, such as in systems where gas and electricity grids create the opportunity for hedging between gas supply and electricity generation based on fuel price differentials, which can also be driven by short-term demand.
- Grid infrastructure and the particular charging structure within a specific market can have plant-specific implications, e.g. transmission losses, grid access and the use of system charges, together with the extent of constrained online periods.
- Regulatory incentives within particular markets to encourage embedded and distributed generation. These can also have an influence on the level of renewable generation, where national targets can be achieved through additional support mechanisms, including supplier obligations or subsidies. [123, Eurelectric 2001]

Location of combustion installations

It is general practice throughout Europe to locate fossil-fuel-burning power plants in locations that incur the minimum costs for installation and operation, allowing also for a number of contributing factors related to the area where the plant is located and the infrastructure to support its operation. Each of these factors varies in significance according to local and national considerations, but in many cases the availability of a connection to the electricity transmission/distribution system, the proximity of the electrical demand, and the availability of water for the cooling systems, and the proximity of mining zones/seaports have often been predominant factors in selecting the location for LCPs. In the past, forecasts of future power demands for individual countries, and the optimum long-term costs for the preferred type of plant, have determined the chosen size and location of power plants.

Since the specific investment costs are substantially lower for larger units ($> 300 \text{ MW}_{\text{th}}$) than for smaller ones ($< 300 \text{ MW}_{\text{th}}$) and the costs of the electricity produced are consequently lower, the capacity of individual units has increased in the last few decades. Whilst this is a recognised driver on mainland, island generators may nonetheless face specific challenges. The size of generators installed on islands is a compromise between the use of the larger power units for enhanced efficiency, whilst maintaining an adequate level of redundancy in case of failure of units. Island generators do not benefit from economies of scale. Flexibility is key when selecting island generators since they need to be operated with high variations of duty cycle resulting from daily and seasonal variations in the island's electricity demand.

Gas compressor stations are situated at fixed distances alongside the transport pipe, and storage plants are located depending on the geological site. Small and reductant compressors may be needed to guarantee optimal gas flow and security of supply.

Other factors are often of less importance when selecting the location of a LCP. The availability of suitable land, the visual and air quality impact on the local environment, and the access for the delivery and storage of fuels are often factors that influence the design and positioning of a power plant. However, these factors are often considered in detail only when the general location has been determined, and do not usually override the decision to proceed with the plant installation.

With the widespread expansion of energy infrastructure taking place in Europe, there are also changes in the relative influence of each of the factors used when selecting the location of the power plant. It is now easier to bring the fuel and power connections to the right location for the plant, rather than to choose the location according to the existing infrastructure. The significant increase in the use of natural gas as a fuel has now resulted in a greater level of gas supply infrastructure, making gas more widely available at the pressure and quantity required for the operation of the gas engines and turbines for power generation, with low transportation costs and no site fuel storage requirements. The expansion of the integrated electricity distribution system has widened the options for achieving good connections for the power-generating plant to supply power into the system. New switchgear and control systems are also enabling more safe and effective connections.

The LCP sector imports a large amount of fuel (including coal and gas) from outside the EU and hence security of supply is an important driver in the design, the technology and in the location of plants. Indigenous supplies will increasingly play a role in maintaining diversity and security of supply, whilst coal plants often seek opportunities to widen their capability to diversify fuels by also burning biomass, wastes and petroleum coke. LCPs may, in the future, need to be more flexible in fuelling, as well as in operation, due to the increase in intermittent renewable energy.

There is a decreasing availability of locations that meet the main requirements for power plants and this may become more important in the future as the increased use of carbon capture and storage (CCS) may influence the siting of new fossil plants to maintain access to CO₂ storage sites. [85, Eurelectric 2012].

At the same time, changes in power generation and abatement techniques have significantly increased the efficiency of power generation, as well as providing far cleaner flue-gases than earlier plants burning fossil fuels. The use of gas turbines for power generation, and the development of new combustion plants and flue-gas treatments have resulted in power plants that can use a range of gaseous, liquid or solid fuels, all emitting far less pollutants per unit of power generated than previously. The overall impact that new plants have on their local environment is significantly less compared to older plants.

In some countries, an area's residential and commercial heat load is an important parameter in locating district heating or combined heat and power (CHP) plants. For district heating, the economically optimised situation leads to calls for peak load production in the same area. In a high load situation, peak load boilers always operate together with CHP plants. This means that each plant feeds the nearby area with a relatively small distance between the consumers and the plant. Connecting CHP and peak load plants to a district heating grid must thus follow certain rules.

Newer plants have higher energy efficiencies, which result, *inter alia*, in a reduced production of emissions (to water and air) per unit of power generated. Future increases of plant efficiency will ultimately be limited because of:

- the laws of thermodynamics;
- the diminishing returns from increasing development costs;
- increasing capital costs resulting in higher generation costs;
- CO₂ capture and storage measures;
- plants not using their full capacity.

The influence of remaining plant life and plant operation

Economic viability for implementing new environmental techniques is relevant since decarbonising electricity generation will require a new tranche of technology and hence a transition from existing to new technology. Future expected lifetime and operating regimes, particularly for existing plants, may well be very different from current ones. Low levels of operation and a limited remaining life are key parameters to consider when assessing the ability to recover further investments in an existing plant. The dependence of costs as a function of remaining plant life and load factor can be assessed on a case-by-case basis (for given assumptions on capital and operating costs, discount rate, and economic lifetime). The level of operation is represented by the plant annual load factor, or equivalent load factor.

In the example below, it is assumed that selective catalytic reduction (SCR) is retrofitted to a 500 MW_{th} coal-fired unit with an annual operating period of 6 000 hours at a cost of EUR 60 million. It is also assumed that the additional operating cost of this SCR is EUR 2.5 million per year (assuming no loss of ash sales). For this exercise, the discount rate is 10 % with costs amortised over 10 years. For this example, Figure 1.13 indicates that the

annualised cost per MWh generated of a retrofitted SCR system rises to around twice the baseload cost when the load factor is 40 %, and that more than doubles again when the load factor reduces to 20 %.

Figure 1.14 indicates that the annualised cost per tonne of pollutant removed doubles from the ‘new plant’ level when the remaining life is 5 years. [85, Eurelectric 2012]

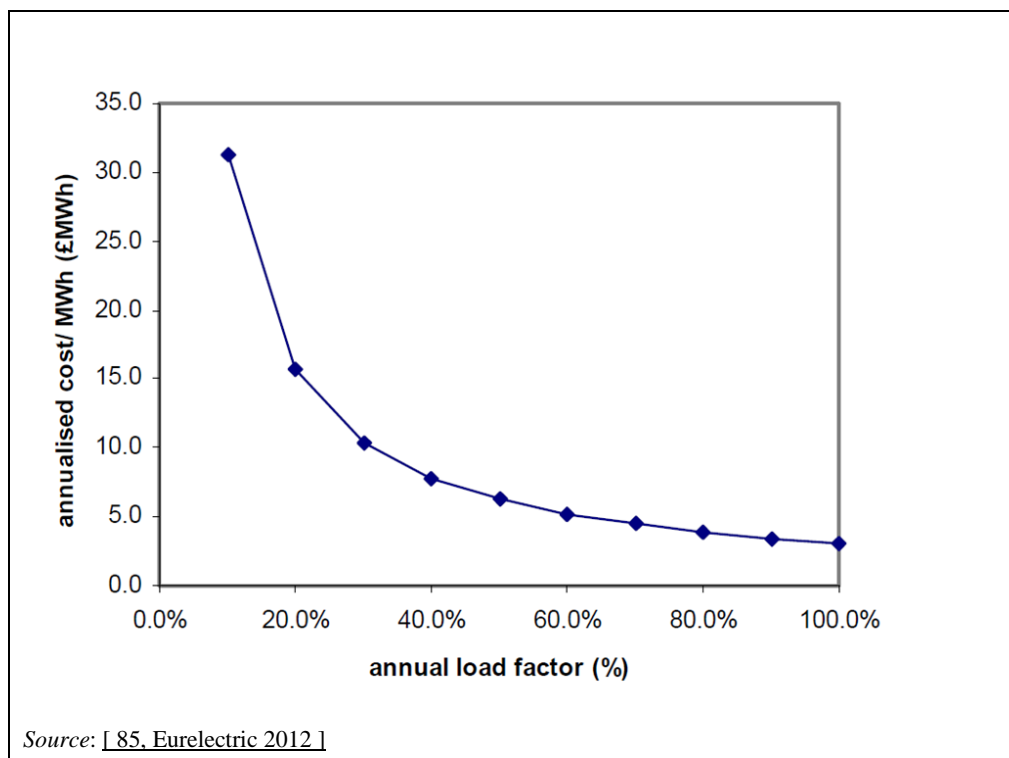

Figure 1.13: Example of annualised abatement cost per unit generated as a function of load factor

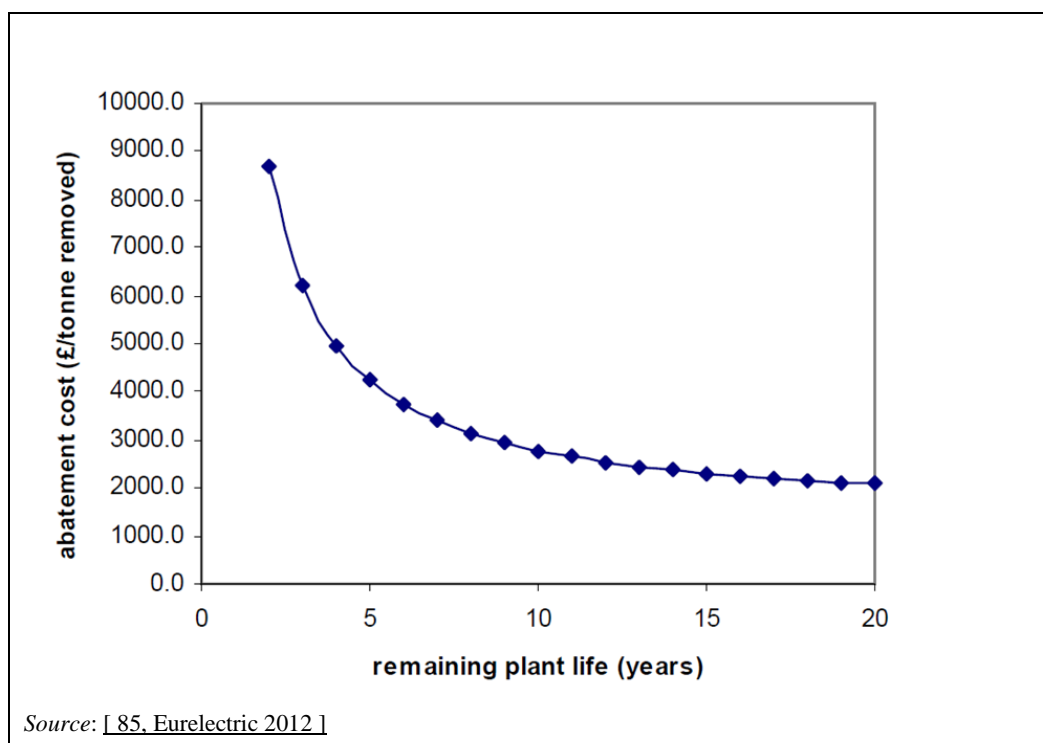
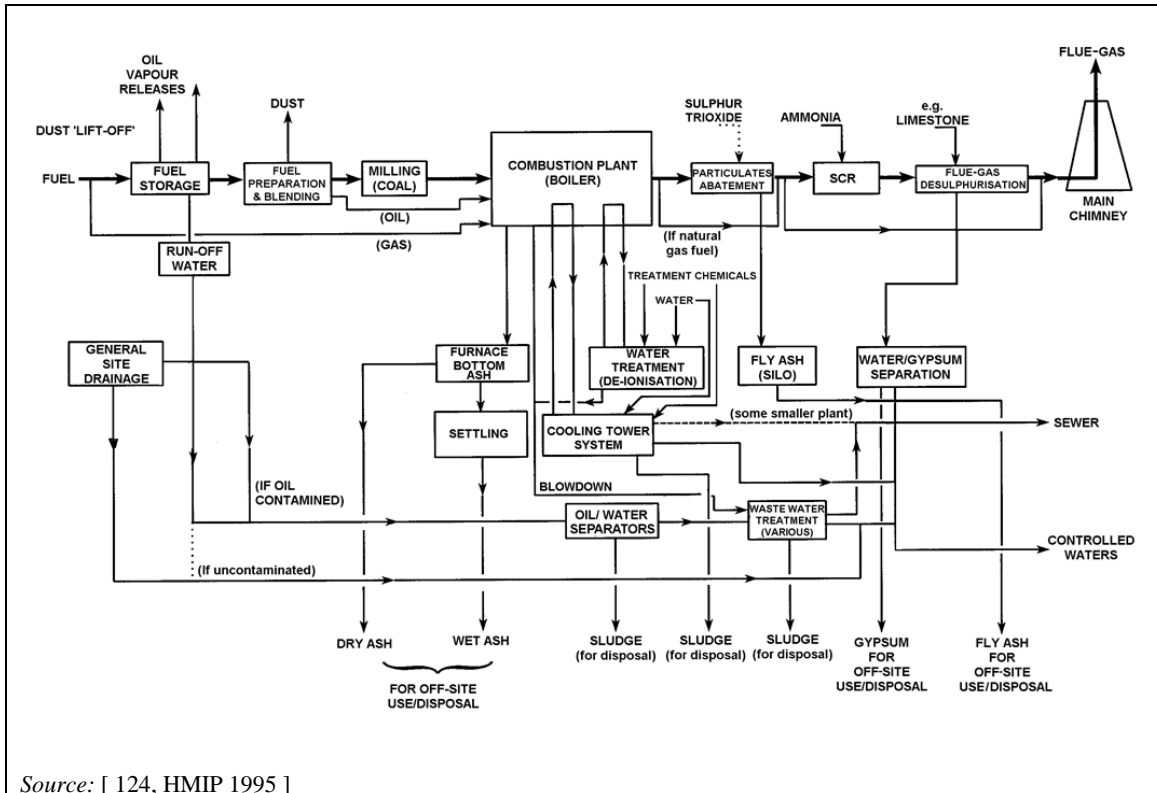

Figure 1.14: Example of annualised abatement cost per tonne of pollutant removed as a function of remaining economic life

1.3 Key environmental issues

The operation of combustion installations to generate electrical energy and/or heat, and in particular the electricity-generating industry due to its large centralised power plants, is a very important cornerstone of our modern society and of the European economy. On the other hand, combustion installations use large amounts of combustible fuels and other raw materials taken from the earth's natural resources, converting them into useful energy. These plants generate a number of residues, wastes and large amounts of emissions to all environmental media. To give an overview of the different mass streams, a general flow diagram of a combustion plant and its associated operations is presented in Figure 1.15.



Source: [124, HMIP 1995]

Figure 1.15: General flow diagram of a combustion plant and its associated operations

Combustible fuels are the principal energy source used today. However, their burning results in a relevant and at times significant impact on the environment as a whole. The combustion process leads to the generation of emissions to air, water and soil, of which emissions to the atmosphere are considered to be one of the main environmental concerns. The following sections give general information about the main substances emitted. An overview of the substances emitted, their sources and their influence on the different environmental media is given in Table 1.4.

Table 1.4: Potential emission pathways by source type and substance

SOURCE RELEASE <u>Air</u> <u>Water</u> <u>Land</u> (A) (W) (L)	Substances												
	Dust	Oxides of sulphur	Oxides of nitrogen	Oxides of carbon	Organic compounds	Acids/alkalis/salts	Hydrogen chloride/fluoride	Volatile organic compounds	Metals and their salts	Chlorine (as hypochlorite)	Mercury and/or cadmium	PAHs	Dioxins
Fuel storage and handling	A				W			A					
Water treatment	W								W		W		
Flue-gas	A	A	A	A	A		A	A	A		A	A	A
Flue-gas treatment	W				W				WL		W		
Site drainage including rainwater	W				W								
Waste water treatment	W L				W	W			L		L		
Cooling water blowdown	W				W				W	W	W		
Cooling tower exhaust								A					

Source: [124, HMIP 1995]

1.3.1 Energy efficiency

Prudent management of natural resources and the efficient use of energy are two of the major requirements of the IED. Therefore, the efficiency with which energy is converted from the fuel now plays an increasingly important role as an indicator of the environmental impact of a process. Energy efficiency is not only important as a marker of the careful treatment of natural fuel resources, it is also an indicator of the emissions that are released in producing a unit of energy. Energy efficiency may be increased by optimising the energy utilisation and the efficiency of the energy-generating process. Optimising the specific energy efficiency depends on a variety of factors, including the nature and quality of fuel, the type of combustion system, the operating temperatures of the gas turbine, reciprocating engine and/or steam turbine, the local climate conditions, the type of cooling system used, the operation cycles, the load factor, the potential for district heating, industrial symbiosis, industrial clustering (in the case of CHP), heat storage or district cooling potential, etc.

Each sequential step in the process of conversion of fuel to useful energy has its own efficiency factor. The overall energy efficiency of the process is achieved by multiplication of all the individual energy efficiency factors.

The net energy efficiency takes all losses into account due to: the auxiliary station supply (and process heat demand), fuel preparation, by-product treatment, flue-gas treatment, waste water treatment, the cooling system, high-voltage transformer, and fans and pumps. Energy efficiency optimisation can be achieved for all efficiency factors, including any devices used for environmental protection. For the supply of electricity, any grid and transformer losses have to be taken into account and, for the supply of heat from Combined Heat and Power (CHP) units, transport losses from the district heating network and cycling pumps have to be taken into account.

Periods of high ambient temperatures at the site decrease electricity production efficiency in both gas and steam plants. For gas turbines and diesel engines, the ambient air temperature is more significant, whereas for steam turbines, the temperature of the cooling media is more important. For the condensation of cooled expanded steam, there are different types of cooling system which can be applied: direct cooling with seawater, lake or river water, or air (air condenser), direct and indirect cooling with wet or dry cooling towers as well as with district

heating water or with industrial process water. Each has different influences on energy efficiency. For more information, refer to the 'Industrial Cooling Systems' BREF.

Energy efficiency and emissions

Even the most efficient condensing power plants may be passing a significant amount of their total energy input to the environment in the form of rejected heat. This heat may be absorbed in the local atmosphere or watercourses with relatively little harm to the local environment, but every unit of energy consumed represents additional emissions passed into the environment. At the present time, the most effective way to improve the energy efficiency of power generation is to maximise the use of the heat produced, and not to waste it.

For waste heat utilisation, several thermodynamic, technical, and economical criteria need to be taken into account. Thermodynamic criteria involve, on one hand, the temperature and, on the other hand, the resulting exergy content of waste heat. The temperature has to be taken into account if the waste heat is to be used for heating. The exergy content has to be taken into account if the waste heat is to be utilised for the production of electricity and power. The technical criteria depend on individual site conditions.

By reducing and utilising waste heat, energy can often be saved, emissions can be reduced and resources can be preserved. There are a wide range of processes that require continuous supplies of heat in the form of steam, hot water, or hot air as inputs to their production and operating facilities. This technique is known as cogeneration or combined heat and power production (CHP). Its associated fuel consumption is usually lower in comparison to the separate production of heat and power. The benefits of increased energy utilisation can result in a reduced rate of emissions of CO₂, nitrogen oxides (NO_x), and other pollutants, depending on the annual utilisation of the CHP process, the fuel substituted, and the potential for replacing small combustion plants with heat from an adjacent power station. However, the magnitude of the beneficial effect of lower overall fuel consumption with CHP is often site-specific and depends on maintaining a high annual utilisation rate, particularly during summertime when the heat load is at its minimum.

Effect of load on plant energy efficiency

At the time of construction, some LCPs are designed for operation at full load or baseload and some other LCPs are designed for operation at fluctuating loads. After a period of operation, other, more efficient or less costly, plants may be constructed forcing older plants to operate at lower and lower loads, before finally being closed. However, it is anticipated that existing fossil-fuel-fired plants will increasingly be required to operate at lower loads and varying loads in the future, as more, intermittent, renewable plants are built. The cost of implementation of retrofitting environmental abatement equipment may also contribute to the decision to operate at lower loads before eventual closure.

Similarly, a plant operating with frequent shutdown and start-up periods is significantly less efficient than if operated at a steady output. [85, Eurelectric 2012]

Banked boilers (boilers that are kept warm for scheduled or emergency use) and intermittently used plants often lead to poor system efficiencies.

1.3.2 Emissions to air

The most important emissions to air from the combustion of combustible fuels are SO₂, NO_x, CO, particulate matter (dust) and greenhouse gases, such as CO₂. Other substances, such as heavy metals, hydrogen fluoride, hydrogen chloride, unburnt hydrocarbons, non-methane volatile organic compounds (NMVOCs) and dioxins, are emitted in smaller quantities but may have a significant influence on the environment due to their toxicity or their persistence. Emissions of fly ash can also include emissions of particulate matter of aerodynamic diameters of less than 10 µm, called PM₁₀.

In accordance with Directive 2001/80/EC on the limitation of emissions of certain pollutants into the air from large combustion plants, the EU Member States report emissions from Large Combustion Plants, including total annual emissions of SO₂, NO_x and dust. Air emissions from non-refinery plants reported by the Member States in 2013 are given in Table 1.5 together with the number of reporting plants and with the total annual amount of energy input. The types of fuel used are given in Table 1.3.

Table 1.5: Air emissions of European large combustion plants (2013)

	Number of plants	MW _{th}	SO ₂ (t)	NO _x (t)	Dust (t)
AT	90	19 709	2 718	6 478	456
BE	86	20 367	2 218	9 558	173
BG	24	23 601	116 666	36 846	4 479
CY	16	3 864	10 396	2 908	345
CZ	101	43 639	98 321	65 802	3 389
DE	560	272 785	160 299	226 042	5 385
DK	73	16 481	3 353	8 533	644
EE	20	10 300	25 992	9 430	7 866
EL	50	24 613	52 736	39 633	12 403
ES	144	77 686	92 841	88 091	4 816
FI	159	30 493	19 308	30 757	1 062
FR	235	79 595	79 640	57 680	4 311
HR	13	4 617	6 925	7 470	109
HU	42	17 665	8 627	12 922	424
IE	27	13 973	10 188	9 245	388
IT	342	136 366	29 963	49 695	1 280
LT	21	12 488	2 094	2 250	138
LU	1	730	2	175	0
LV	20	5 711	49	1 054	2
MT	9	1 745	4 880	2 954	228
NL	146	50 529	9 681	21 367	355
PL	96	104 409	324 712	219 905	15 490
PT	26	12 387	5 760	8 435	288
RO	85	36 459	160 211	42 065	10 007
SE	128	28 340	1 794	6 314	449
SI	16	4 653	5 292	8 430	269
SK	63	11 286	40 076	11 978	706
UK	248	152 905	152 644	198 000	6 947
<i>Source:</i> [113, EEA 2013]					

1.3.2.1 Sulphur oxides (SO_x)

Emissions of sulphur oxides result mainly from the presence of sulphur in the fuel. Fossil fuel contains sulphur as inorganic sulphides or organic compounds. For example, sulphur appears in coal as pyritic sulphur, organic sulphur, sulphur salts and elemental sulphur. During combustion, by far the majority of sulphur oxides are produced in the form of sulphur dioxide (SO₂).

When combusting solid and liquid fuels, the presence of transition metals in the fuel also causes the catalytic oxidation of 0.5 % to 4 % of the sulphur to sulphur trioxide (SO₃) during the combustion. An additional oxidation can take place in plants fitted with SCR, where SO₃ emissions may account for about 5 % of the total sulphur emitted. Sulphur trioxide is adsorbed

on dust and, in the case of solid fuels, can aid the operation of electrostatic precipitators. For liquid fuels, high levels of SO₃ contribute to the formation of acid soots.

Additionally, ‘blue smoke’ can be emitted from boilers fired with heavy fuel oil. It is assumed that this optical phenomenon is caused by the progressive hydration of SO₃ to sulphuric acid aerosol with SO₃ production enhanced by the vanadium content of the oil and probably also by the SCR catalyst.

Natural gas is generally considered free from sulphur. This may not be the case for certain industrial gases, and desulphurisation of the gaseous fuel might then be necessary [125, OSPAR 1997].

SO_x/SO₂ emissions to air are shown in Figure 1.16 by industry sector. In 2014, 458 facilities in the 'Thermal power stations and other combustion installations' sector emitted a total of 1 259 kt of SO_x/SO₂ emissions to air, representing 66.9 % of the total amount emitted by all installations covered by the E-PRTR.

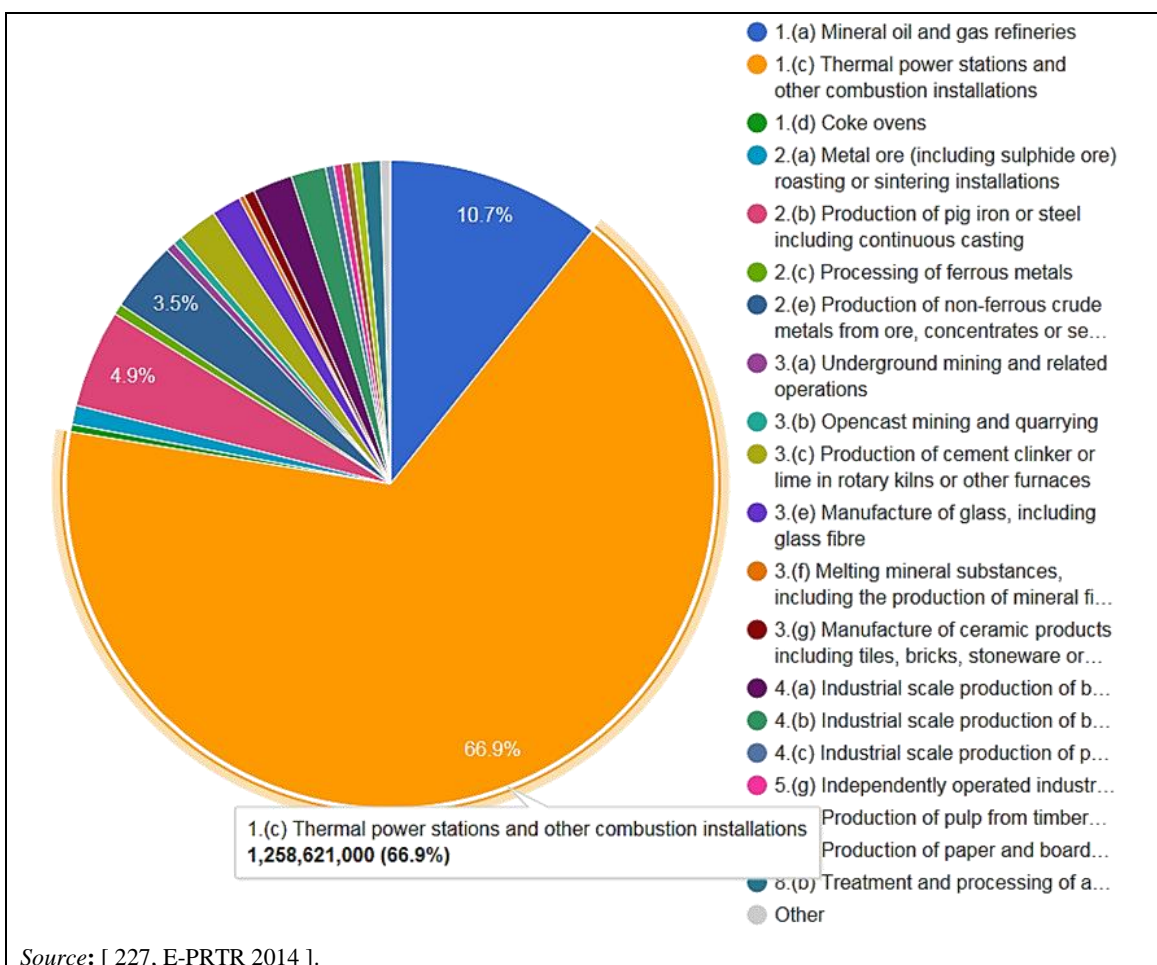

Figure 1.16: Emissions of SO_x/SO₂ to air by industry sector/activity in the EU-28 in 2014

1.3.2.2 Nitrogen oxides (NO_x)

The principal oxides of nitrogen emitted during the combustion of fossil fuels are nitric oxide (NO), nitrogen dioxide (NO₂), and nitrous oxide (N₂O). The first two of these form the mixture known as NO_x, which accounts for the great majority of the oxides of nitrogen in the main types of large combustion installations.

The formation of NO_x is governed by three essential mechanisms; characterised by the origin of the nitrogen and the environment where the reaction takes place:

- thermal NO_x results from the reaction between the oxygen and nitrogen from the air;
- fuel NO_x is formed from the nitrogen contained in the fuel;
- prompt NO_x is formed by the conversion of molecular nitrogen in the flame front, in the presence of intermediate hydrocarbon compounds.

The quantity of NO_x formed by the prompt NO_x mechanism is generally much smaller than that generated by the other reaction paths.

The formation of thermal NO_x greatly depends on temperature. When combustion can be achieved with temperatures below 1 000 °C, emissions of NO_x are significantly lower. When the peak flame temperature is below 1 000 °C, the formation of NO_x mostly depends on the fuel nitrogen.

The formation of fuel NO_x depends on the nitrogen content of the fuel and the oxygen concentration of the reaction medium. The quantity of fuel NO_x produced is greater in installations using coal, as this has larger amounts of nitrogen in its structure than other types of fuel. The mean nitrogen contents generally found in different types of fuel are given in Table 1.6.

Table 1.6: Fuel-bound nitrogen

Fuel	Fuel-bound nitrogen (wt-%, dry, ash-free basis)
Coal	0.5–2
Biomass (wood)	< 0.5
Peat	1.5–2.5
Fuel oil	< 1.0
Natural gas	0.0
Derived gases	0.1–1 (\gg 1 chemical sources)

The type of combustion process used also affects the amounts of nitrogen oxides emitted. In the case of coal, for example:

- NO_x emissions are lower with a moving grate boiler because of the relatively low combustion temperature and the progressive nature of the combustion as it advances over the grate;
- emissions are higher in a pulverised coal boiler, varying with the type of burner and the design of the combustion chamber;
- NO_x emissions in a fluidised bed boiler are lower than those produced in conventional boilers, but N_2O emissions can be higher if the furnace operating temperature is too low.

The formation of thermal NO_x is the dominant pathway by which NO_x is generated in installations using gaseous and distillate liquid fuels. The quantity of fuel NO_x produced is greater in installations using coal and heavy fuel oil, as these have larger amounts of fuel-bound nitrogen.

The formation mechanism of nitrous oxide (N_2O) has not yet been completely clarified. There is a possible formation mechanism based on intermediate products (HCN , NH_3), which is comparable to the formation of NO . It has been found that lower combustion temperatures, i.e. below 1 000 °C, cause higher N_2O emissions. At lower temperatures, the N_2O molecule is

relatively stable; at higher temperatures, the N₂O formed is reduced to N₂. Compared to emissions from conventional stationary combustion units, nitrous oxide from either bubbling, circulating or pressurised fluidised bed combustion is relatively high. Nitrous oxide (N₂O) also contributes directly to the greenhouse climatic effects through thermal infrared absorption in the troposphere. The tropospheric lifetime of N₂O is quite long, as its interaction with other gases, clouds, and aerosols is minimal. N₂O is decomposed in the presence of O₃ and forms NO₂ and NO, noted as NO_x.

NO_x/NO₂ emissions to air are shown in Figure 1.17 by industry sector. In 2014, 892 facilities in the 'Thermal power stations and other combustion installations' sector emitted a total of 1 186 kt of NO_x/NO₂ emissions to air, representing 55.6 % of the total amount emitted by all installations covered by the E-PRTR.

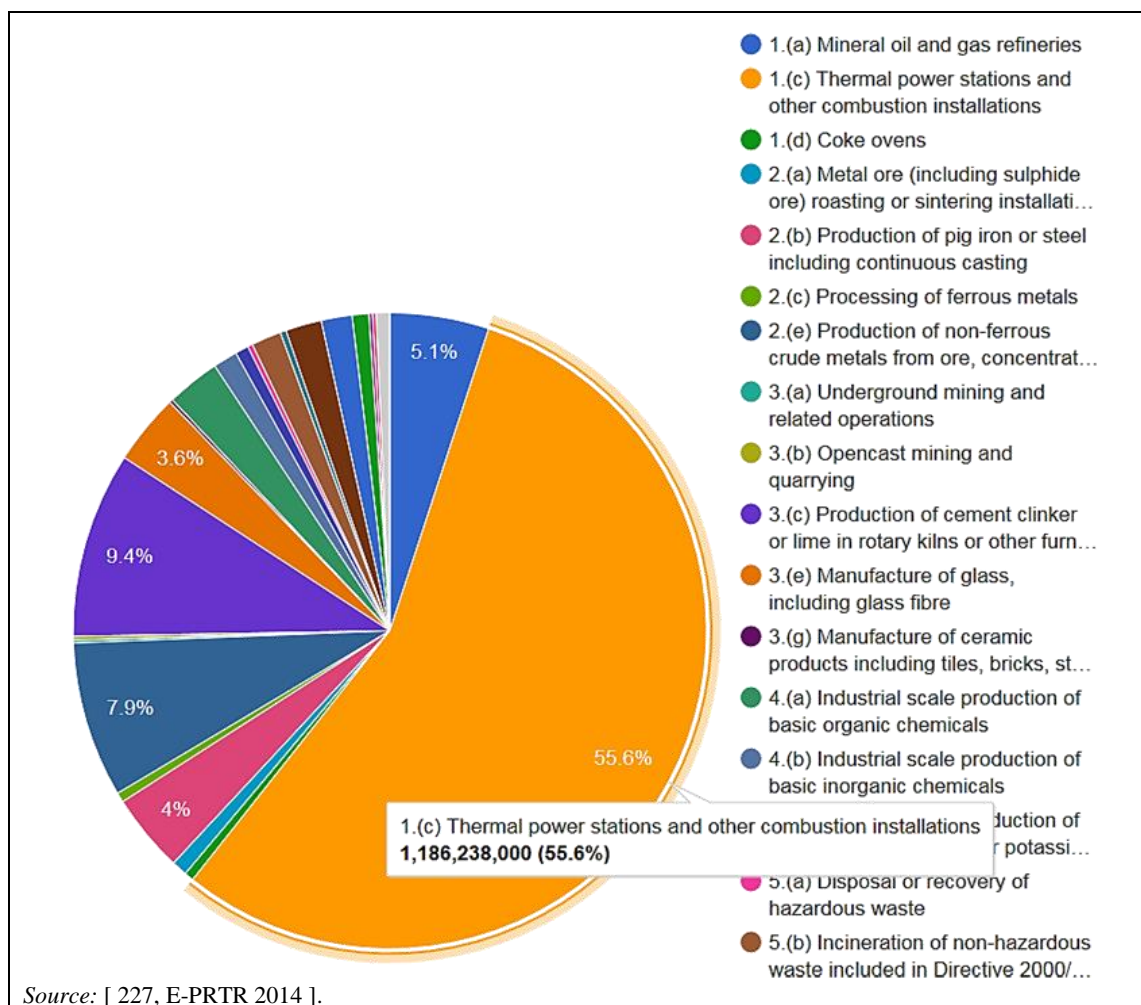

Figure 1.17: Emissions of NO_x/NO₂ to air by industry sector/activity in the EU-28 in 2014

1.3.2.3 Dust

The dust emitted during the burning of coal, peat and biomass arises almost entirely from the mineral fraction of the fuel. A small proportion of the dust may consist of unburnt fuel carbon and very small particles formed by the condensation of compounds volatilised during combustion.

The type of combustion process has a considerable effect on the proportion of ash entrained in the flue-gas emissions from boilers. For example, moving grate boilers produce a relatively small amount of fly ash (20–40 % of total ash), whereas pulverised coal boilers produce an appreciable amount (80–90 %).

The combustion of liquid fuels is also a source of particulate emissions, although to a lesser extent than coal. In particular, poor combustion conditions lead to the formation of soot, which is liable to produce acidic agglomerates with corrosive properties in the presence of sulphur trioxide.

The combustion of natural gas is not a significant source of dust emissions. On the other hand, some industrial gases may contain particles which are filtered out in the production process or, failing that, before combustion.

For many installations, there are also potential diffuse emissions (open-air handling and storage of coal, the crushing of the coal used in pulverised coal boilers, the handling of ash, etc.). [[125, OSPAR 1997](#)]

Environmental problems, in particular health impacts, are especially associated with particles less than 2.5 µm in diameter, which can remain suspended in the atmosphere for days or even weeks. Environmental problems can also occur by long-term accumulation of persistent compounds after deposition on the soil or by solution and transfer to water bodies. The distance that particles travel before they are removed from the air by settling or by precipitation depends on their physical characteristics and on the weather conditions. The size, density and shape influence the rate at which particles settle. Particles larger than 10 µm in diameter settle fairly rapidly. Their impact is primarily near the source. Smaller particles of less than 10 µm and especially those less than 2.5 µm can travel over hundreds of kilometres before settling. Aerosols often function as condensation nuclei for cloud formation and are washed out with rain.

Industrial emission control techniques for particulate matter (PM) are very efficient, achieving more than 99.8 % by weight removal from the raw gas input. Achievable reduction rates depend on the secondary abatement technology used and might for some other fuels, such as oil, be lower due to the different particulate composition and sizes. Only for small particles, such as for PM₁₀ and below, does the removal efficiency decrease to between 95 % and 98 %. For this reason, the majority of particles from LCPs still emitted to the air are in the 0.1 µm to 10 µm diameter range.

PM₁₀ emissions to air are shown in Figure 1.18 by industry sector. In 2014, 165 facilities in the 'Thermal power stations and other combustion installations' sector emitted a total of 49 kt of PM₁₀ emissions to air, representing 48.1 % of the total amount emitted by all installations covered by the E-PRTR.

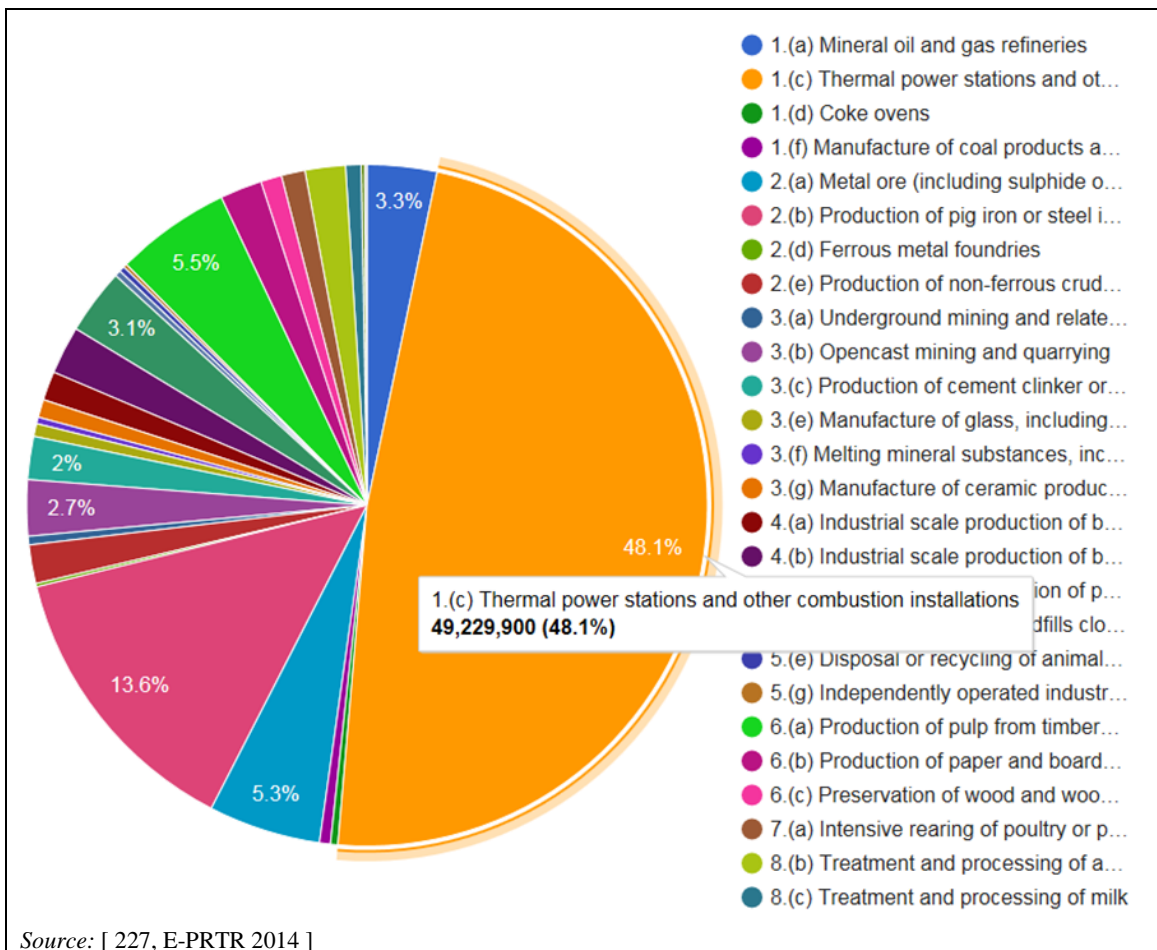

Figure 1.18: Emissions of PM₁₀ to air by industry sector/activity in the EU-28 in 2014

1.3.2.4 Metals

The emission of metals results from their presence as natural substances in fuels. Most of the metals considered (As, Cd, Cr, Cu, Hg, Ni, Pb, Se, Zn, V) are normally released as compounds (e.g. oxides, chlorides) in association with particulates. Only Hg and Se are at least partly present in the vapour phase. Hg in particular is known as a long-range transboundary pollutant which can create pollution problems in areas far away from the emission source. Less volatile elements tend to condense onto the surface of smaller particles in the flue-gas stream. Enrichment in the finest particle fractions is, therefore, observed. Partitioning, for example, of metals during coal combustion is shown in Figure 1.19.

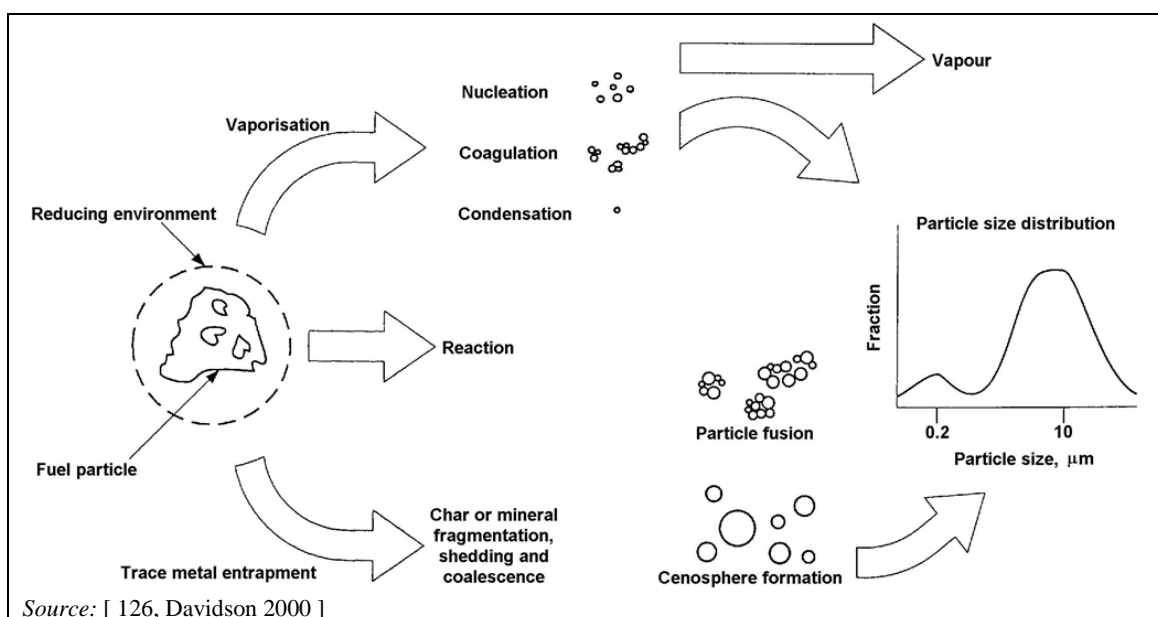

Figure 1.19: Partitioning of metals during coal combustion

The content of metals in coal is normally several orders of magnitude higher than in oil (except occasionally for Ni and V in heavy fuel oil) or natural gas. Many of the metals are chemically bound in compounds, like oxides, sulphates, aluminosilicates, and minerals, such as anhydrites and gypsum. The release of the elements depends on the nature and particle size of the compound. During the combustion of coal, for example, particles undergo complex changes which lead to vaporisation of volatile elements. The rate of volatilisation of metal compounds depends on the fuel characteristics (e.g. concentrations in coal, fraction of inorganic compounds such as calcium) and the characteristics of the technology applied (e.g. type of boiler, operating mode).

As a consequence, different metals are found in different proportions in fly ashes and bottom ashes. For example, manganese and iron have similar enrichment in fly ash and bottom ash, and their level is low in stack particulate emissions. By contrast, up to 80 % of cadmium, tin, zinc, lead, antimony and copper is retained in the fly ash and about 5–10 % is retained in the bottom ash. However, only 15 % of selenium and 2 % of arsenic is retained within the solid particles, and only about 5 % of these elements is retained in the bottom ash. A similarly high proportion of Mercury is released in the atmosphere -- up to 85 % of mercury is either emitted in the atmosphere or captured in solid fly ash particles, and a negligible amount is retained in the bottom ash.

Coal combustion releases mercury in oxidised (Hg^{2+}), elemental (Hg^0) or particulate-bound (Hgp) form. Mercury is present in the coal in trace amounts, and the combustion process releases this into the exhaust gas as elemental mercury. This may then be oxidised via homogeneous (gas-gas) or heterogeneous (gas-solid) reactions. The primary homogeneous oxidation mechanism is the reaction with gas-phase chlorine to form HgCl_2 , whilst heterogeneous oxidation reactions are believed to occur on the surface of the fly ash and unburnt carbon (UBC). The mercury which is adsorbed onto solid surfaces is known as particulate-bound mercury.

Oxidised mercury is prevalent in the flue-gas from coal combustion, and, being water-soluble, is relatively easy to capture using SO_2 controls such as wet limestone scrubbers. The concentration of halides (i.e. chloride) in the flue-gas is relevant as they promote the oxidation of mercury. Particulate-bound mercury is also relatively easy to capture in existing particulate control devices. Elemental mercury, present in higher concentrations in the flue-gases of lignite combustion, is more difficult to capture with the existing pollution controls prevalent in lignite-fired plants (i.e. without SCR). This combines with lower levels of fly ash carbon content to

give higher emissions of mercury from these fuels. Adsorption/absorption of mercury on particles is lower in this case.

Elemental mercury has a lifetime in the atmosphere of up to one year, whilst oxidised forms of mercury have a lifetime of a few days or less, due to their higher solubility in atmospheric moisture. Elemental mercury can therefore be transported over long distances, whereas oxidised and particulate mercury deposits near the point of emission.

Hg emissions to air by industry sector are shown in Figure 1.20. In 2014, 169 facilities in the 'Thermal power stations and other combustion installations' sector emitted a total of 13.7 tonnes of Hg emissions to air, representing 51.4 % of the total amount emitted by all installations covered by the E-PRTR.

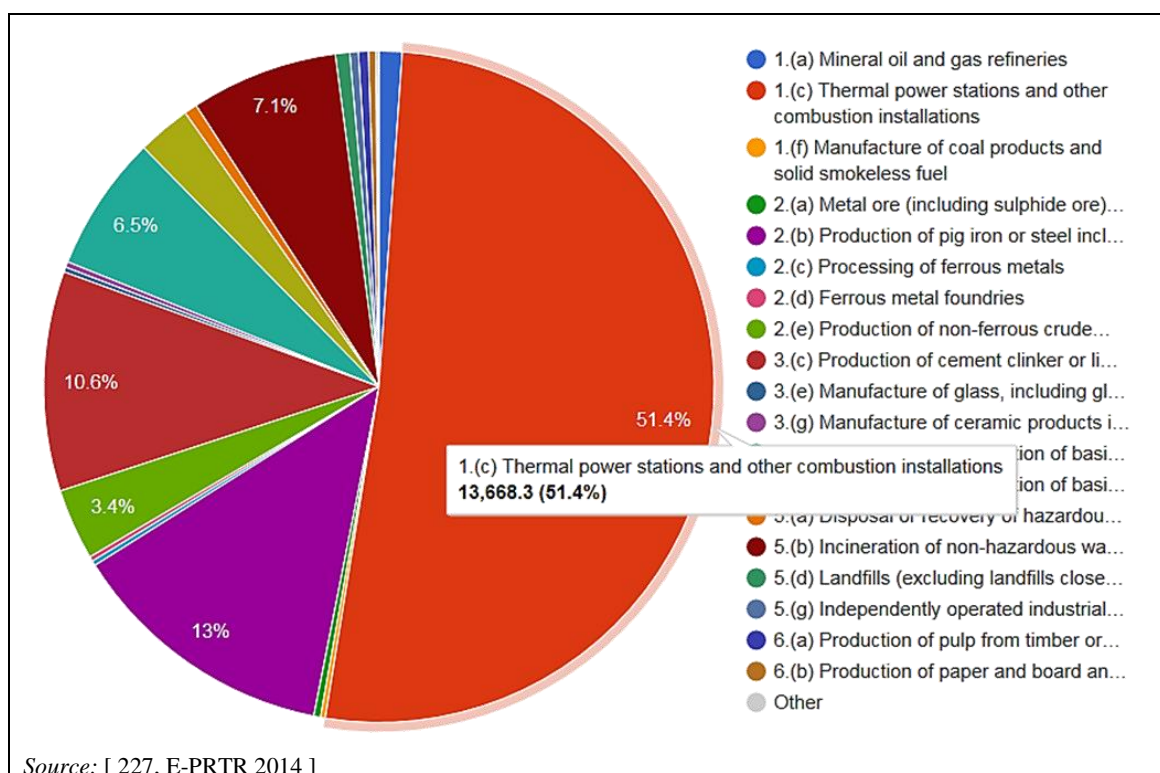

Figure 1.20: Emissions of Hg to air by industry sector/activity in the EU-28 in 2014

1.3.2.5 Carbon monoxide (CO)

Carbon monoxide (CO) always appears as an intermediate product of the combustion process, particularly in substoichiometric combustion conditions. Plant operators always try to minimise CO formation, as CO is an indicator of corrosion risk and unburnt fuel, and therefore signifies a loss of efficiency. The formation mechanisms of CO, thermal NO and VOCs are all similarly influenced by combustion conditions. [127, Corinair 1996]

CO emissions to air are shown in Figure 1.21 by industry sector. In 2014, 108 facilities in the 'Thermal power stations and other combustion installations' sector emitted a total of 264 kt of CO emissions to air, representing 8.1 % of the total amount emitted by all installations covered by the E-PRTR.

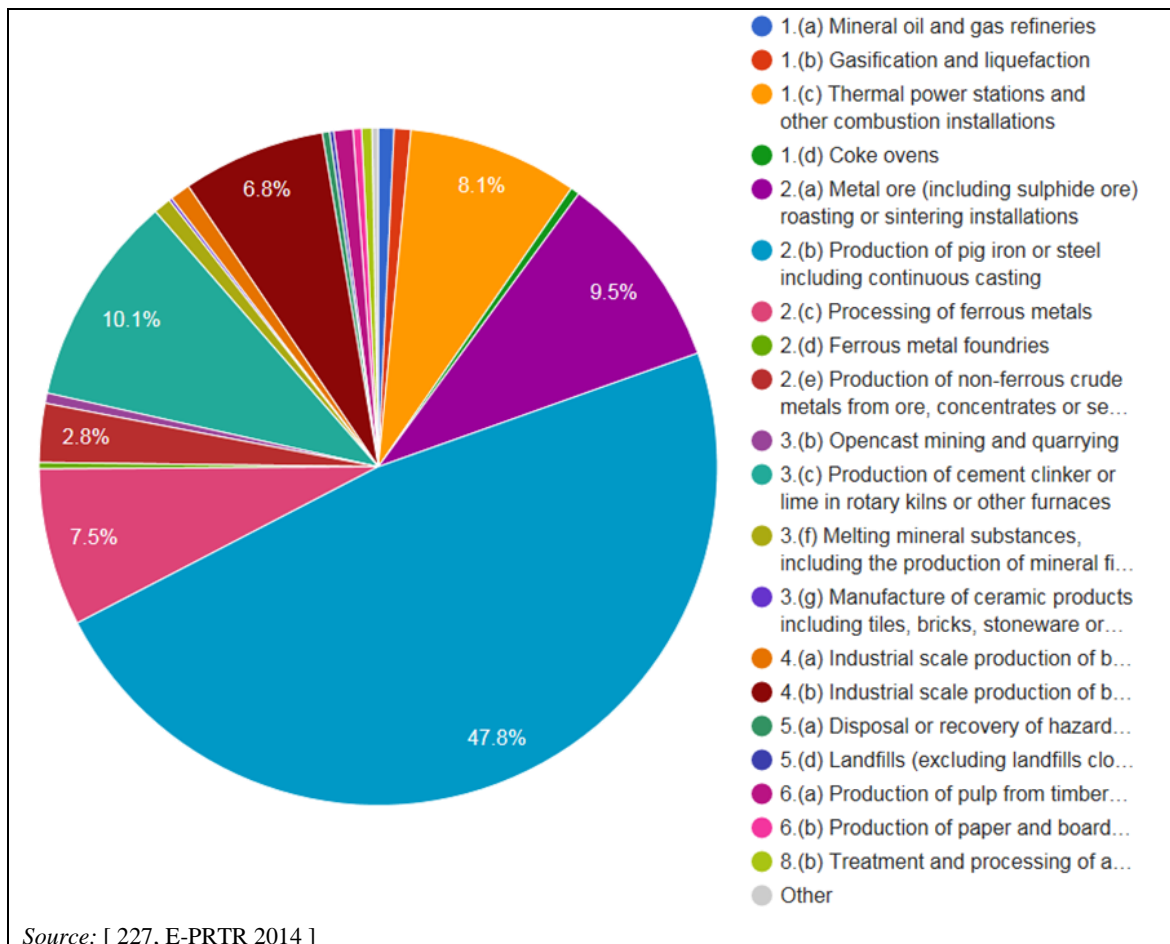

Figure 1.21: Emissions of CO to air by industry sector/activity in the EU-28 in 2014

1.3.2.6 Greenhouse gases

Greenhouse gases have an effect on global warming in relation to their potential for trapping heat in the atmosphere. Carbon dioxide (CO₂), nitrous oxide (N₂O), sulphur hexafluoride (SF₆), and methane (CH₄) are the most important greenhouse gases associated with LCPs. Emissions of CO₂, N₂O, SF₆ and CH₄ to air in the EU-28 in 2014 are shown by industry sector/activity in Figure 1.22, Figure 1.23, Figure 1.24 and Figure 1.25.

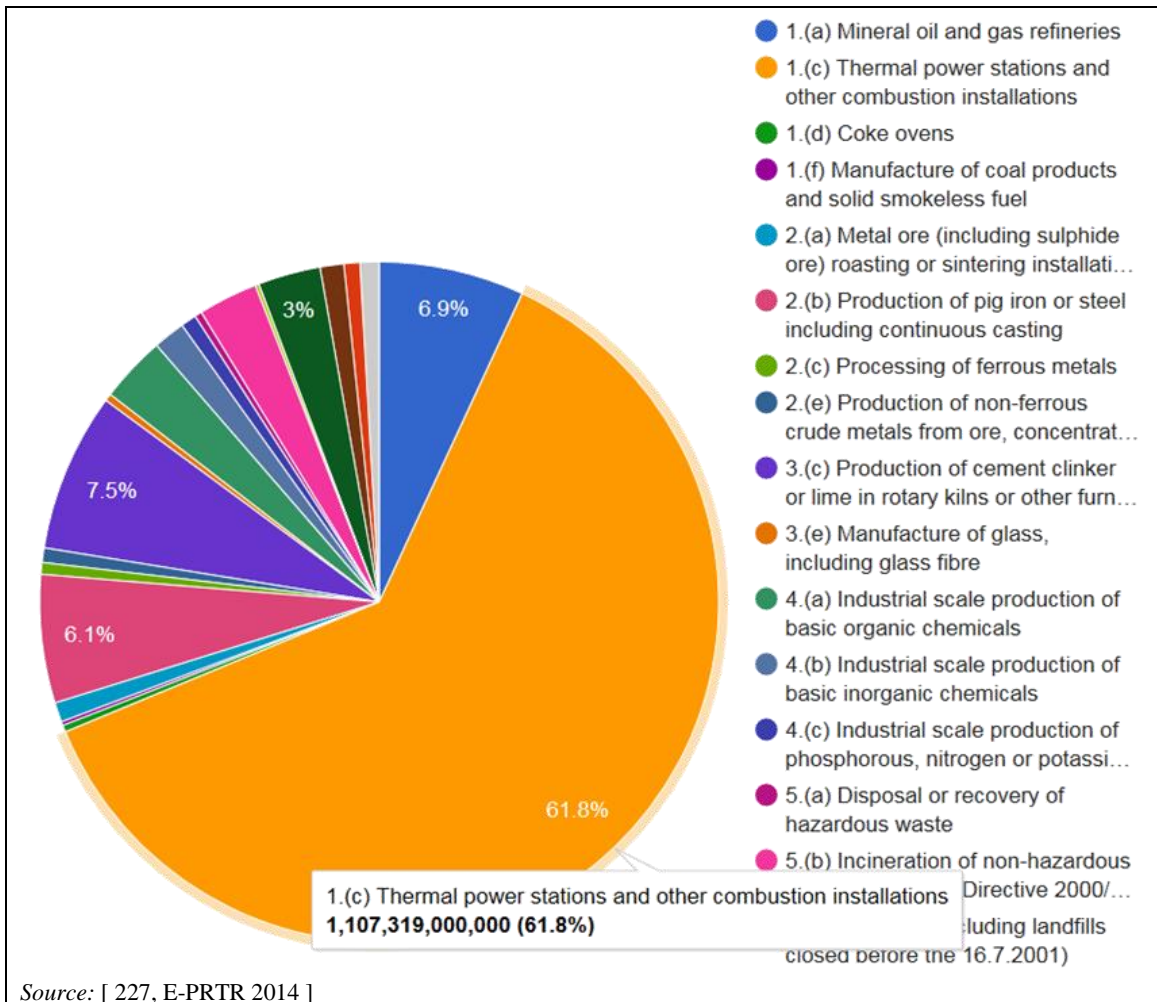

Figure 1.22: Emissions of CO₂ to air by industry sector/activity in the EU-28 in 2014

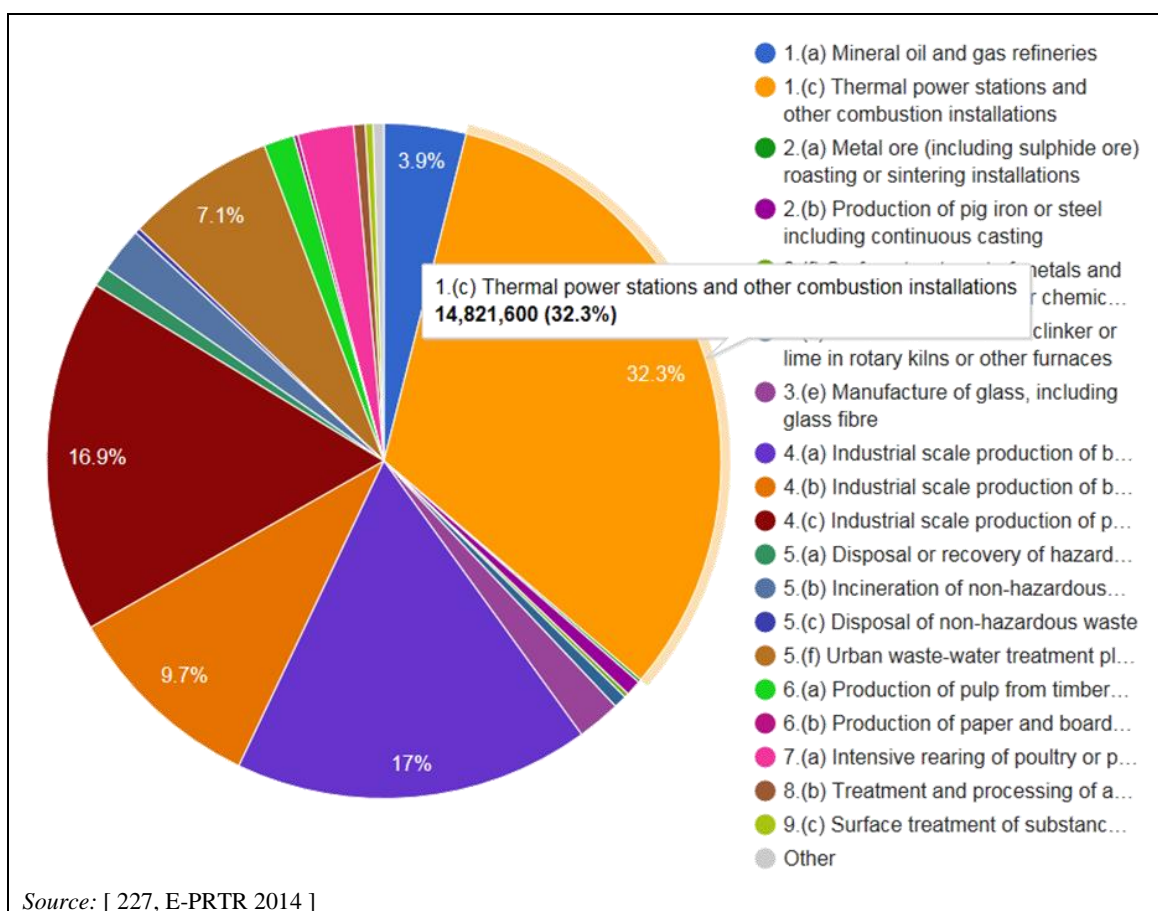

Figure 1.23: Emissions of N_2O to air by industry sector/activity in the EU-28 in 2014

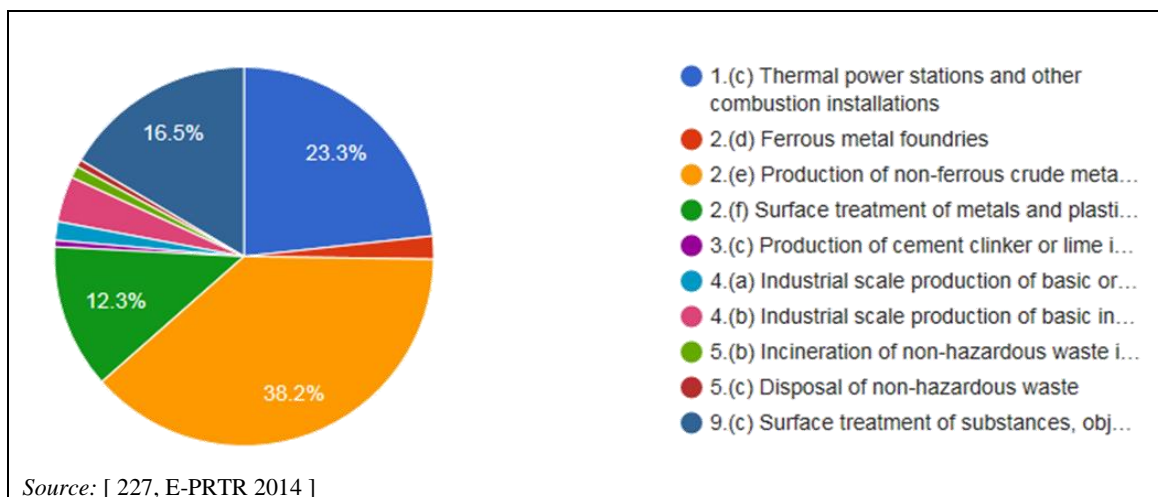

Figure 1.24: Emissions of SF_6 to air by industry sector/activity in the EU-28 in 2014

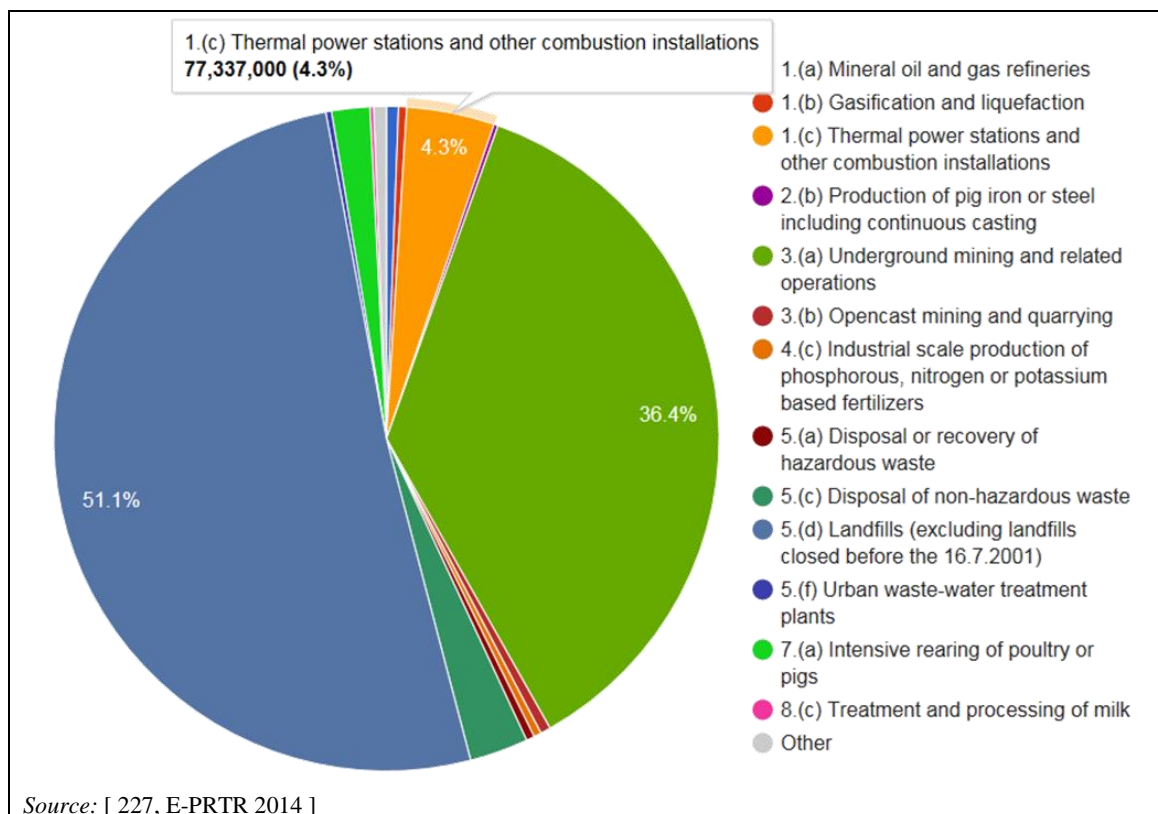

Figure 1.25: Emissions of CH₄ to air by industry sector/activity in the EU-28 in 2014

1.3.2.7 Hydrogen chloride (HCl)

LCPs without flue-gas desulphurisation (FGD) are recognised as a major source of industrial hydrogen chloride emissions to the atmosphere. The emission of hydrogen chloride is due to trace amounts of chloride present in fossil fuels such as coal, oil and biomass. When fossil fuels are burnt, small amounts of chloride are released. Some of that chloride then combines with hydrogen to form hydrogen chloride. Together with the moisture in the air, hydrogen chloride transforms to a hydrochloric acid aerosol that contributes to acidification problems. This becomes more dilute as it moves through the atmosphere.

HCl emissions to air are shown in Figure 1.26 by industry sector. In 2014, 202 facilities in the 'Thermal power stations and other combustion installations' sector emitted a total of 22 kt of chlorine and inorganic compounds (as HCl) emissions to air, representing 77.1 % of the total amount emitted by all installations covered by the E-PRTR.

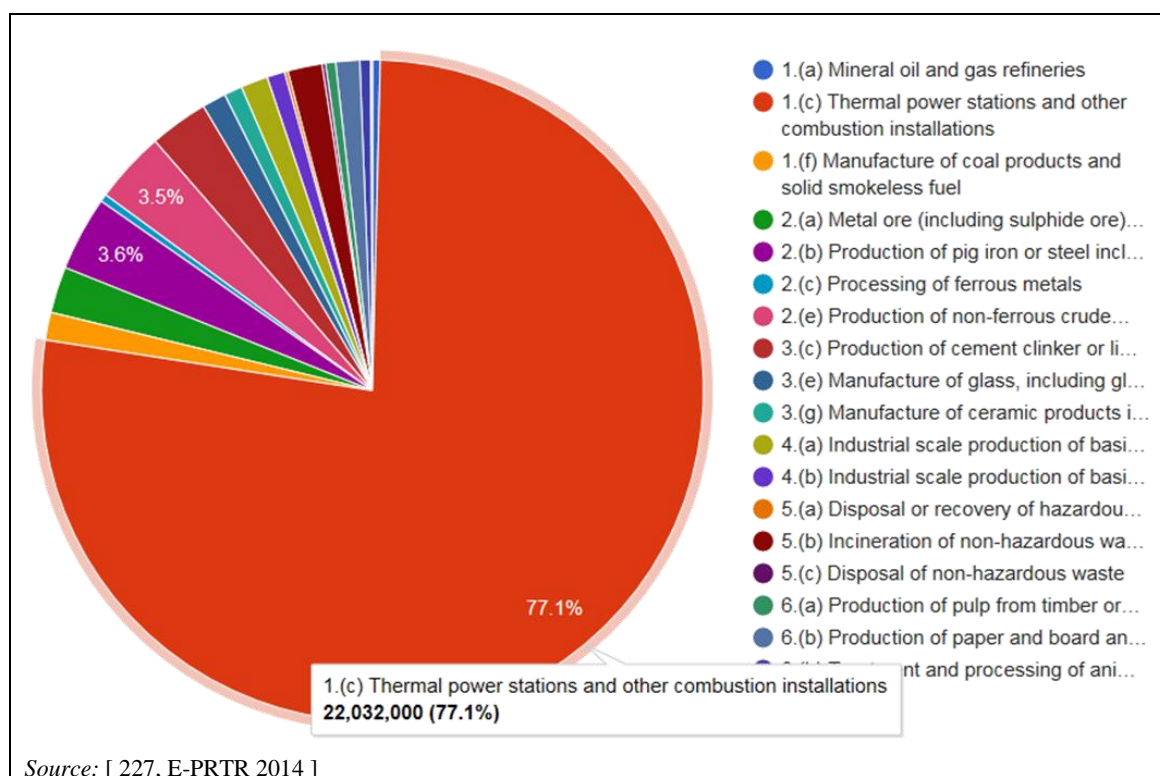

Figure 1.26: Emissions of chlorine and inorganic compounds (as HCl) to air by industry sector/activity in the EU-28 in 2014

1.3.2.8 Hydrogen fluoride (HF)

Like chloride, fluoride is also a natural element present in fossil fuels and biomass. When using such fuels such as coal for generating energy, without using FGD, fluoride is liberated and released to the flue-gas. It then combines with hydrogen to form hydrogen fluoride, and with the moisture of the ambient air to form hydrofluoric acid.

HF emissions to air are shown in Figure 1.27 by industry sector. In 2014, 110 facilities in the 'Thermal power stations and other combustion installations' sector emitted a total of 3.57 kt of fluorine and inorganic compounds (as HF) to air, representing 71.9 % of the total amount emitted by all installations covered by the E-PRTR.

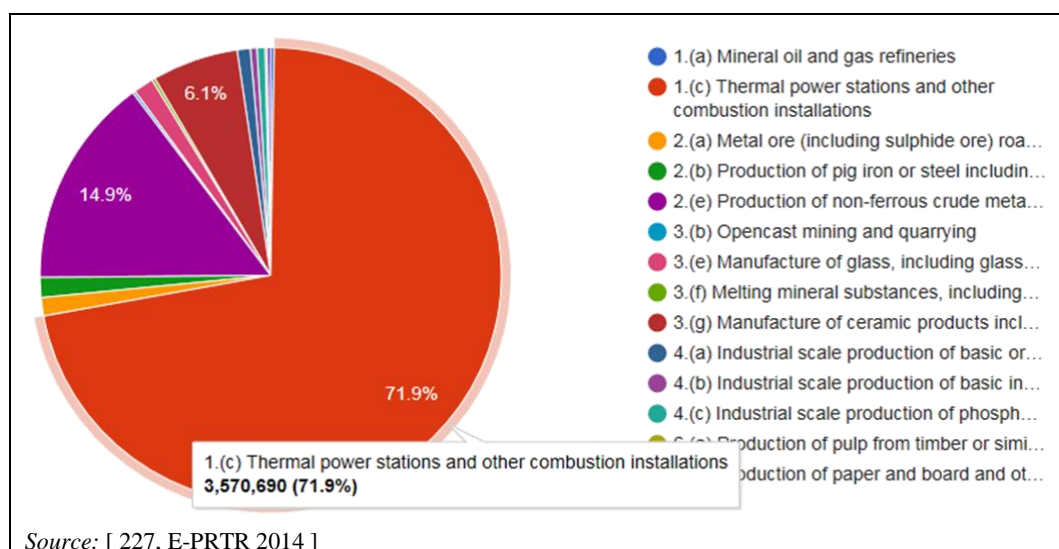

Figure 1.27: Emissions of HF to air by industry sector/activity in the EU-28 in 2014

1.3.2.9 Ammonia (NH₃)

The emission of ammonia (NH₃) does not result from the combustion of fossil fuels, but rather as a consequence of the incomplete reaction of ammonia in the DeNO_x process. Ammonia is used as reagent, as pure ammonia, or in water solution in SCR and SNCR units. Ammonia chemically reacts to form NH₄HSO₄ and is removed together with the fly ash from the system and also, being a soluble gas, via a wet FGD scrubber. With no dust removal or FGD downstream (DeNO_x tail-end configuration), the 'ammonia slip' is then emitted along with the flue-gas to the atmosphere. The ammonia slip at SCR and SNCR installations increases with an increasing NH₃ to NO_x ratio, but also, with SCR, with decreasing catalyst activity. A low amount of NH₃ in by-products can be guaranteed by proper maintenance of the catalyst system.

The US EPA identified ammonia as the single largest precursor of fine particulate (2.5 microns in size and smaller) air pollution in the country. [128, Heide 2011]

In 2014, 33 facilities in the 'Thermal power stations and other combustion installations' sector emitted a total of 997 tonnes of NH₃ emissions to air, representing 0.5 % of the total amount emitted by all installations covered by the E-PRTR (the bulk of ammonia emissions is associated with the rearing of pigs and poultry). [227, E-PRTR 2014]

1.3.2.10 Volatile organic compounds (VOCs)

The emission sources of volatile organic compounds due to industrial activities are numerous, but the combustion of fuels is one of the most significant.

Non-methane volatile organic compounds (NMVOC) emissions to air are shown in Figure 1.28 by industry sector. In 2014, 95 facilities in the 'Thermal power stations and other combustion installations' sector emitted a total of 40.24 kt of NMVOC to air, representing 10.4 % of the total amount emitted by all installations covered by the E-PRTR.

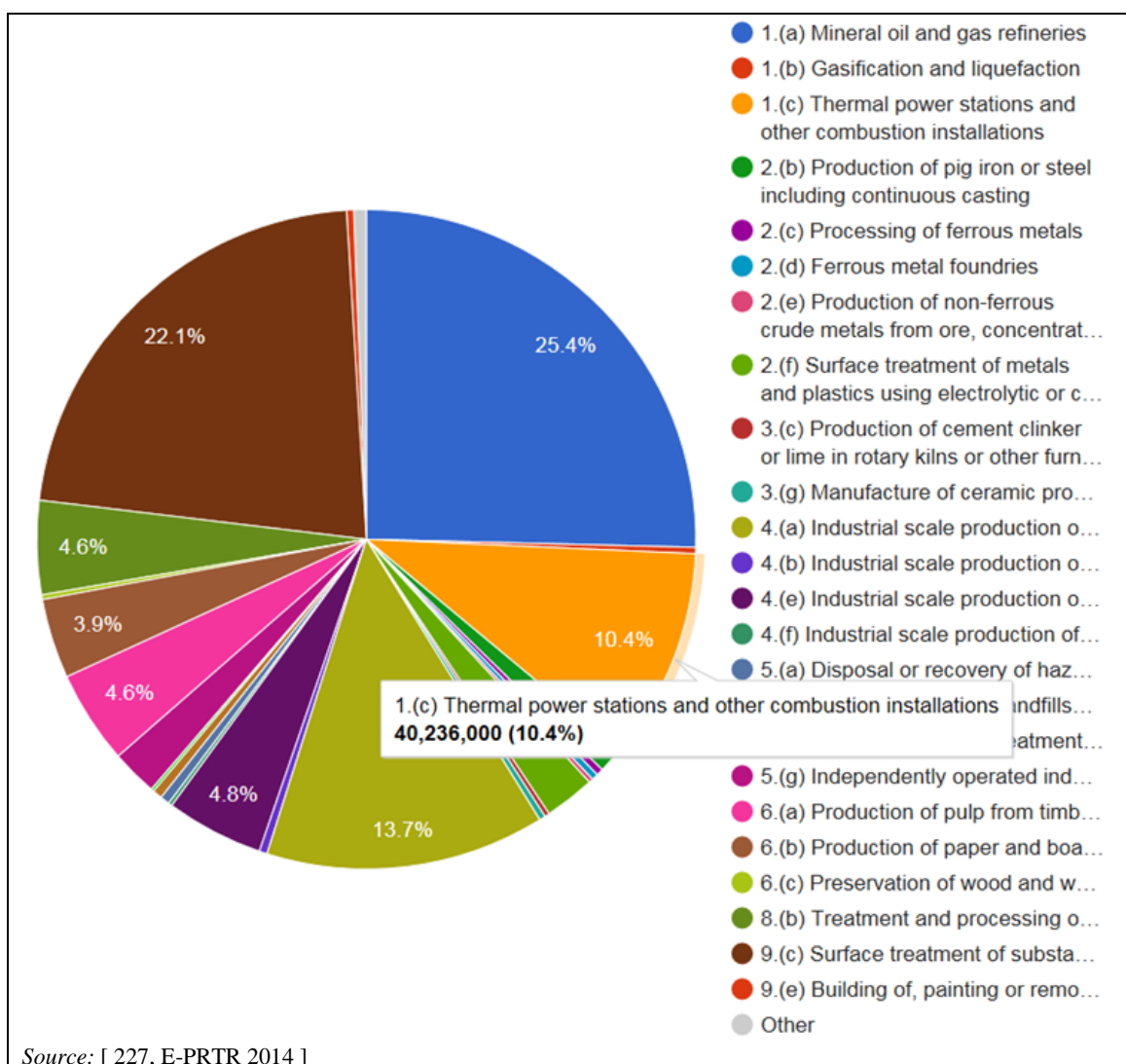

Figure 1.28: Emissions of NMVOC to air by industry sector/activity in the EU-28 in 2014

1.3.2.11 Persistent organic pollutants (POPs): polycyclic aromatic hydrocarbons (PAHs), dioxins and furans

Among the persistent organic compounds liable to be emitted during the combustion of fuels, polycyclic aromatic hydrocarbons (PAHs), polychlorinated dibenzo-dioxins (PCDD) and polychlorinated dibenzo-furans (PCDF) should be mentioned.

Three general mechanisms have been postulated to account for the emission of PAHs from combustion processes [129, Sloss et al. 1993]:

- PAHs present in feed material such as fossil fuel or waste can pass through the combustion system without being destroyed;
- reformation of ring structures from fragments and precursors can lead to formation in the combustion zone, or downstream, at temperatures around 700 °C; and
- carbon chains may form aromatic rings and further on PAHs – *de novo* synthesis.

The *de novo* synthesis of PAHs is thought to occur via oligomerisation and cyclisation of acetylenes which are formed as a consequence of incomplete combustion. The reactions take place in the gas phase.

Besides the combustion of coal, combustion installations using wood or other solid biomass are also mentioned as a possible source of PCDD/F emissions. The main process involved is the recycling of wood for power production, for example in the form of chipboard or of waste from wood that has been treated or that includes chlorinated organic compounds (PCP, lindane, PVC, NH₄Cl, etc.). Moreover, the introduction of a combined combustion of waste (sewage sludge, plastics and others) in certain conventional combustion installations could also lead to significant emissions of dioxins [125, OSPAR 1997]. PCDD/F may also form in catalytic reactions of carbon or carbon compounds with inorganic chlorine compounds over metal oxides, e.g. copper. These reactions will occur especially on fly ash or filter dust at temperatures between 200 °C and 450 °C.

PCDD/F are not very volatile molecules and, when adsorbed on particles produced by combustion, they have a high thermal and chemical stability in the environment. They can only be destroyed above temperatures of 1 000 °C. In this context, it should be noted that PCDD/F are not only found in the stack gases but also in the solid residues from any combustion process, such as in bottom ashes, slags, and fly ash.

1.3.3 Emissions to water

Besides the generation of air pollution, LCPs are also a significant source of water discharge (cooling and waste water) into rivers, lakes and the marine environment. These discharges may cause water quality problems, which can vary widely, depending on the type of fuel used, the abatement technique applied, the cooling technique and consequently the amount of water used, and the chemical and biological treatment reagents added for cleaning and maintenance purposes. The main sources of effluent streams in a fossil-fuel-fired combustion plant are shown in Figure 1.29.

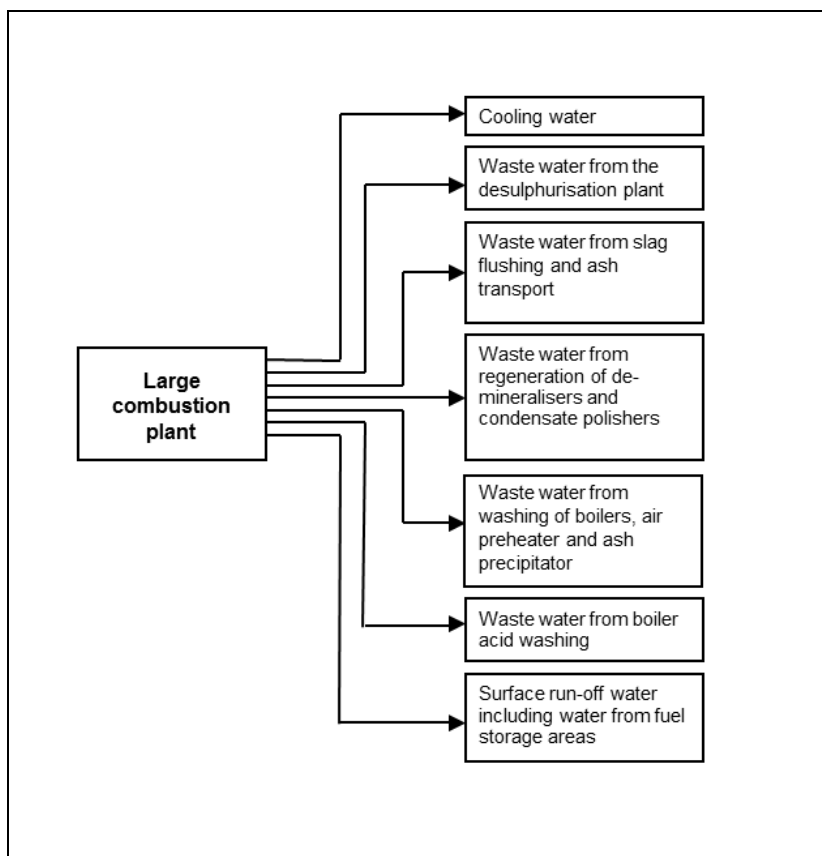

Figure 1.29: Effluents from fossil-fuel-fired large combustion plants

The thermal efficiency of a combustion cycle is restricted by the thermodynamic limits of the ‘Carnot cycle’, which is the theoretical combustion cycle. This means that not all the chemically bound energy of a fossil fuel can be transformed into mechanical energy, and hence into electrical energy. The result is that a significant proportion of the energy provided by combustion must be dissipated at the condenser level and transferred to the surrounding environment as heat. Many combustion plants use large amounts of cooling water as a cooling medium, which they take either from rivers, lakes, groundwater bodies or the sea.

The waste heat is transferred (using cooling techniques such as once-through systems or wet cooling towers) into the cooling water and, further, to the aquatic environment. The environmental impact of industrial cooling, and thus also of cooling techniques used in LCPs are described in the BREF on industrial cooling systems (ICS).

The waste water streams mentioned above can be contaminated by a variety of different water-polluting substances.

Table 1.7 shows the generally relevant water-polluting parameters from LCPs. However, the significance of each parameter depends on the quality of the raw water, the specific plant configuration and the processes applied, which also determines the type and amount of pollutant present in waste water prior to treatment. The contents of Table 1.7 do not fully apply to gas- and liquid-fired power plants.

Table 1.7: List of water pollutants from LCPs

Parameter/pollutant	Parameter/pollutant*
pH	N (total)
Temperature	P (total)
Colour	As
TSS	Cd
TDS	Cr
BOD	Cu
COD	Hg
Mineral oils	Ni
Free chlorine	Pb
NH ₃	Zn
Sb	AOX
As	PCDD+PCDF (as TEQ)
Co	Phenols (as total C)
Mn	PAHs
Tl	TOC
V	Chloride (as total Cl)
Sn	Fluoride (as total F)
CN	Fluoranthene
S	
SO ₃	
SO ₄	
EOX	
Phenol	
PCDD/PCDF	
* According to Appendix 5 of the guidance document for the implementation of the E-PRTR (31 may 2006).	

Because of their chemical, biological and/or physical behaviour, such compounds may have a high impact on the aquatic environment. These substances can cause changes in the receiving water, such as increasing its acidity or alkalinity thereby changing its pH value, salinity, or reducing its oxygen content and increasing plant growth due to the emission of plant nutrients.

For instance, water from slag flushing and ash transport has an alkaline character due to the composition of the ash, whereas water from boiler washing is acidic. Waste water from the wet desulphurisation plant contains salts such as chlorides and sulphates.

1.3.4 Combustion residues

The combustion of fuels is associated with the generation of a variety of residues (wastes and/or by-products). Substances or objects resulting from a production process, the primary aim of which is not the production of that item, may be regarded as not waste but as by-products if the proper requirements for them to be sold on the market are met (e.g. fly ash, gypsum from flue-gas desulphurisation). According to their origin, residues from a combustion plant can be divided into those directly related to the process of combustion or those generated by the operation of the plant and its equipment, such as coal mills or water treatment facilities. Residues directly related to the combustion of fuels are ashes (fly and bottom ash) and residues that are generated by the desulphurisation of flue-gases. Within the EU (EU-15) about 48 300 kt of residues were produced from coal combustion in 2010, of which about 25 290 kt were utilised in construction (51.7 %), 19 500 kt in reclamation (40 %) and about 1 000 kt was disposed of (6.4 %). [64, ECOBA 2010]

The main residues generated by LCPs are as follows:

- **Bottom ash and/or boiler slag:** Bottom ash is a non-combustible material that settles to the bottom of the boiler and remains in the form of unconsolidated ash. If combustion temperatures exceed the ash fusion temperature, the ash remains as slag in a molten state until it is drained from the bottom of the boiler as boiler slag.
- **Fluidised bed ash:** The operation of a fluidised bed combustion installation with a solid fuel, such as coal, lignite, biomass or peat, results in the generation of ash, which is a composition of spent bed material and fuel ash. Bed ash is removed from the bottom of the fluidised bed combustion chamber.
- **Fly ash:** Fly ash represents the part of the non-combustible material that is carried out of the boiler along with the flue-gas. Fly ash is collected from the particulate control equipment, such as from the electrostatic precipitator or bag filter, and also from different parts of the boiler, such as the economiser and the air preheater. The largest amount of ash is generated by the combustion of coal and lignite, followed by the combustion of peat and biomass, whereas gas-fired facilities generate very low quantities of ash. The amount of ash generated from a liquid-fuel-fired facility is much higher than from a gas-fired boiler, but, compared with the amount of ash from coal combustion, the quantities are relatively small.
- **Flue-gas desulphurisation residues:** Fuels such as coal, peat and oil contain varying amounts of sulphur. To avoid high emissions of sulphur dioxide to the atmosphere, LCPs (in particular plants over 100 MW_{th}) are usually equipped with flue-gas desulphurisation (FGD) systems. The different desulphurisation techniques currently in use result in the generation of a number of residues. Wet lime/limestone scrubbers, for instance, generate gypsum as a by-product, whereas dry scrubber systems generate a mixture of unreacted sorbent (e.g. lime, limestone, sodium carbonates, calcium carbonates), sulphur salts and fly ash as residue.

Ash and flue-gas desulphurisation residues are by far the largest quantities of residues from LCPs. These residues may be disposed of as wastes to a landfill or can be used as by-products for different purposes, such as in cement and concrete production; as aggregate in concrete and asphalt, for mine reclamation or waste stabilisation; and as an ingredient in many other products.

Gypsum, a by-product from the desulphurisation plant, is widely used in the cement and gypsum industry, e.g. for the production of plasterboard, and makes a significant and increasing contribution to meeting the demand for gypsum.

Beside the residues that are directly related to the combustion process and which arise in large volumes, lower volume residues are generated as a result of the plant and equipment operation. Typical examples of such residues are as follows:

- **Residues from boiler cleaning:** Residues generated during the maintenance of the gas and water sides of the boiler, including the air preheater, economiser, superheater, stack, condenser and ancillary equipment. On the gas side, combustion residues such as soot and fly ash build up on the surface of the equipment and must be removed periodically. On the water side, scale and corrosion products build up in the boiler and need to be removed from time to time, using acid or alkaline solutions.
- **Rejects from solid fuel milling:** Solid fuels such as coal and lignite are normally reduced in size in order to be able to blow them into the boiler. During the milling of coal, any rocks and pyrites (an iron-based mineral) need to be separated from the fuel stream. This solid residue may be discharged together with the bottom ash.
- **Make-up water treatment sludge:** Residues resulting from the treatment of make-up water for the steam cycle. The treatment of boiler make-up water may include different processes such as settling, flocculation, softening, filtration and osmosis. These treatment methods result in the generation of a treatment sludge.
- **Spent ion exchange resins:** Ion exchange resins are used for the treatment of boiler make-up water.
- **Spent catalysts from SCR processes:** SCR catalysts are used to reduce nitrogen oxide emissions to the atmosphere. Due to deactivation, these catalysts have to be replaced periodically (after several years of service). Today, different processes exist for the regeneration of such catalytic materials. Used catalyst elements are usually sent back to the catalyst manufacturer for preparation for their reuse.
- **Waste water treatment sludge:** Sludge generated by treating the different waste water streams from a LCP.
- **Laboratory waste:** Small amounts of waste generated in the laboratory, for instance by analysing fuel samples, intake water, by-products, residues, etc.
- **Other residues:** Other residues include those resulting from the purging of plant equipment for maintenance, used oil and equipment containing oil, equipment containing PCBs, and waste from the treatment of fuel (e.g. coal washing).

Most of the above-mentioned residues, from both the combustion process (e.g. ash) and from the desulphurisation process (e.g. gypsum), and any other residue from the combustion plant may represent a potential environmental risk. Ash from a coal-fired boiler, for instance, contains elements such as silicon, aluminium, iron, calcium, magnesium, potassium, sodium and titanium, as well as metals such as antimony, arsenic, barium, cadmium, chromium, lead, mercury, selenium, strontium, zinc and others.

Current EU legislation regards many of the above-mentioned residues from combustion plants as wastes. However, for many decades, industry has put great effort into developing ways to minimise the generation of residues and/or to reuse them in various industrial sectors, such as in the cement and construction industry, such that the quantities of waste disposed of to landfill have actually been reduced. According to Directive 2008/98/EC of the European Parliament and of the Council, this is beneficial to the environment because the utilisation of residues as raw materials helps to conserve natural resources and to minimise the total amount of wastes to be landfilled. As an example, the use of coal ash has been shown to reduce the overall amount of CO₂ emitted in the production of cement, due to the reduced amount of limestone to be calcined. [85, Eurelectric 2012]

With respect to bottom and fly ash from coal combustion, both are composed of various elements from soil associated with the coal. One of their most distinctive characteristics is that

the bulk of this material is in a powdered or sintered state, with most of the elements contained within a glassy matrix, and this basically determines their legal classification in national and international waste lists as an inert, inactive or non-hazardous residue (e.g. non-hazardous wastes in the European list of wastes - Decision 2001/118/EC amending Decision 2000/532/EC, and also in the 'green' list of the OECD Decision C (92)39/final).

It is also well known that some by-products, such as gypsum from the desulphurisation plant, have a strong commercial share of the gypsum market and are used as the most important raw material in the production of gypsum boards. These efforts made by industry help to reduce cross-media effects and the risk of environmental damage as well as reducing the need to mine natural gypsum.

1.3.5 Noise and vibration

Noise and vibration are common issues arising from the operation of LCPs; turbines in particular have the potential for high noise emissions. Process noise emitted from an installation into the surrounding environment is a factor that has caused many complaints in the past and some information needs to be given about causes and approaches to prevent and minimise noise and vibration.

The most significant sources of noise are from the transport and handling of fuels and residues (waste and by-products); the use of large pumps and fans; safety valves; the cooling technique; and from boilers, steam and gas turbines or other stationary engines. Noise and vibration can be measured in a number of ways, but often the specific method is site-specific and takes account of the frequency of the sound and the location of residential areas (sensitive receptors).

The impact of noise emitted from a combustion plant is limited to a relatively small area surrounding the installation. Accordingly, the most frequent problem, especially at night, can be noise nuisance for people living in the area close to the plant. For this reason, in some countries, plants are subject to more stringent permissible noise levels at night than during the day.

1.3.6 Emissions of radioactive substances

Natural radioactive substances are not covered by the IED, according to IED Article 3.1 (a). However, it has been agreed within the technical working group on LCPs to include some information on the emission of natural radioactive substances released by the combustion of fossil fuels in the general part of this document.

Emissions of radioactive substances naturally present in most fossil fuels are not considered to be a key environmental issue LCPs. Over recent years, European society (especially people living close to LCPs) has become increasingly wary of radiation releases from the utilisation of fossil fuels, in particular the combustion of large amounts of coal. In practice, emissions to air of radioactive substances from a particular power plant or stack have been found to be close to undetectable in comparison with natural background radiation.

An examination of the radioactivity of solid material passing through power plants has shown that more than 90 % of the radioactivity in coal is retained in the ash. Only a small percentage of the radioactivity can be found in flue-gas desulphurisation products such as FGD gypsum. Radionuclide concentration in ash is determined by the radionuclide concentration of the coal, the ash content of the coal and the conditions at the power station. Because of the ash content, natural radioactive nuclide concentrations in fly ash exceed those in coal by a factor of 2 to 15. International measurement results of radioactivity in the fly ash generated by coal burning range between 60 Bq/kg and 1 000 Bq/kg. Mean data values range from 90 Bq/kg to 180 Bq/kg, with peak values of up to 1 000 Bq/kg for the uranium series, and from 70 Bq/kg to 150 Bq/kg, with peak values of up to 290 Bq/kg for the thorium series.

Peat ash is used as a landfill, for landscaping, in concrete, and as a bulk material for road construction. It may also be taken to dumps or mounded. The radiation exposure from the handling and utilisation of peat ash has been estimated with activity indices. In peat ash, the activity concentrations of radionuclides are 20–25 times higher than in peat itself. The concentrations of radium and thorium are of the same magnitude as those in soil and rock. The concentration of uranium (up to 1 000 Bq/kg) is on average about 25 times higher than that in sand and gravel.

1.3.7 Mitigation of environmental impacts

The preceding sections set out the range and magnitude of the potential environmental impacts from LCPs if abatement techniques are not applied.

The actual impacts can be managed by the selection of appropriate techniques according to the principles of BAT. The following chapters of this document set out the techniques that are available to mitigate the potential environmental impacts.

Consequently, the actual impacts of a given LCP will depend on the total package of mitigating measures that are applied during the plant design, operation, and decommissioning.

1.3.8 Introduction to the integrated approach of protecting the environment as a whole

Below, the integrated approach is discussed from three points of view [[130, Finland 2000](#)]:

- mutual influence of the emission reduction techniques for different pollutants through the inherent characteristics of the LCP process in question;
- dependence on the performance of a given pollutant emission abatement technique on other environmental aspects and on the use of energy and consumables as well as on economics;
- the need to find an appropriate balance between environmental benefits (reduction of different pollutant emissions), cross-media effects and economics.

An example of mutual influence in LCP pollution is the interdependence between the emissions of NO_x from a low- NO_x burner, the unburnt carbon, CO and hydrocarbons. Attempts to minimise the NO_x formation at some point cause the unburnt fraction of the fuel to increase rapidly. This not only reduces combustion efficiency, but also creates new pollutants, CO and unburnt hydrocarbons. Furthermore, EN 197-1 defines a limit for loss on ignition (method to measure unburnt carbon, determined in accordance with EN 197-2) of the fly ash, beyond which the fly ash is no longer recyclable in cement or in the construction industry, creating the need for fly ash disposal in landfill.

Another example is the dependence of NO_x and N_2O formation on the fluidised bed combustion temperature. NO_x formation can be minimised by decreasing the bed temperature of the FBC boiler, but, at some point, the rate of N_2O formation starts to increase. A compromise has to be found between combustion temperatures and a judgement on which one will achieve the best overall balance. In addition to the oxides of nitrogen, sulphur capture in the bed of a FBC boiler by limestone addition is also influenced by the bed temperature.

Yet another example is the catalytic reduction of NO_x . While it provides an effective means to reduce NO_x emissions, it introduces a tiny ammonia emission (ammonia slip) into the environment. Moreover, the transportation, handling and storage of ammonia itself create an environmental hazard. The risk is less severe at smaller plants where an aqueous solution of

ammonia is customarily used but at large plants where pure ammonia is used the consequences of an accident may be severe.

When considering the performance of a pollution abatement technique versus the economic cost of applying that technique, as well as the requirements for energy and consumables and the need to handle any waste substances created, the general rule of thumb in many techniques is that better results can be achieved by investing more money. An example is sulphur reduction in FBC boilers. The degree of sulphur capture by limestone addition into the FBC bed improves as more excess limestone is used. Therefore, a high sulphur reduction simultaneously demands an increased use of limestone. This in turn means higher amounts of ash to deposit somewhere. Both the use of limestone and the increased amount of ash are environmentally undesirable side effects of improved sulphur capture in a FBC boiler. Another result of a high calcium content in the ash may be that it renders the ash unusable. The situation with respect to calcium consumption is qualitatively similar in semi-dry flue-gas desulphurisation.

In wet scrubbing desulphurisation, excess calcium is not needed. Moreover, it cannot be used if commercial-quality gypsum is the desired end-product. However, to achieve a higher reduction efficiency, a larger scrubbing reactor is required, and more electric energy is used in the scrubbing suspension circulation pumps, the induced draught fans associated with the scrubber and in the associated heat exchangers. When high sulphur reduction is desired, the increase in calcium consumption and gypsum production is small, but more electric energy is consumed and thus more CO₂ is released to the air.

The particle removal efficiency of both the electrostatic precipitator and the bag filter can be increased almost indefinitely by increasing the size, and hence also the cost of the equipment. The conditions with respect to the selective catalytic reduction of NO_x are analogous: by adding more catalyst elements, better reduction and lower ammonia slip can be achieved.

1.3.9 Plant-specific data collection for the LCP sector

Information and data on environmental performances of large combustion plants were collected at European level, among other ways, by means of plant-specific questionnaires in 2012. The purpose of the questionnaires was to obtain plant-level information and data regarding the environmental performance of existing combustion plants/installations.

Each questionnaire/LCP was assigned a specific individual code (e.g. 543-1), which is used in the rest of this document to identify each LCP. For the assessment, the codes were completed by coupling the number identifying the plant, with the following characters:

- V for validated questionnaires (questionnaire filled in and sent by the operator, checked by the relevant Member State, double-checked by the EIPPCB, updated and sent again by the operator via the Member State – e.g. 543-1V).
- NV for not completely validated (questionnaire filled in and sent by the operator, checked by the relevant Member State, double-checked by the EIPPCB, but not updated by the operator – e.g. 432NV).
- No character added (questionnaire filled in and sent by the operator, checked by the relevant Member State, double-checked by the EIPPCB, without a reply from the operator – e.g. 536).
- C for 'corrected' questionnaires when the uncertainty of measurement related to the reported data was re-added to these data in order to make all the submitted data comparable (i.e. without subtraction of the uncertainty). The 'correction' was done by re-adding the absolute value, or a percentage, depending on the type of information provided in the questionnaire. Where no information on uncertainty was provided, a 'by-default' uncertainty corresponding to 2 % for CO emissions, 3 % for NO_x and SO_x emissions, and 4 % for dust emissions was re-added.

The collected data and information have been extensively used in the BREF and the combustion plants' performances shown in tables or graphs are flagged by means of the above-mentioned codes. In the case of graphs for emissions to water, there is no correction of the uncertainty. The list of codes and plant names can be found in Annex I. [3, LCP TWG 2012]

The reported air emission data used for the analysis are without subtraction of the measurement uncertainty. Information on the averaged uncertainty assigned to measured results from European combustion plants, derived from data collected at plant level through the questionnaires is given in Annex IV.

2 PROCESSES FOR ENERGY GENERATION

2.1 Combustion principles

A boiler requires a source of heat at a sufficient temperature to produce steam. Fuels, when used for the generation of steam, are generally burnt in the furnace or combustion chamber of the boiler. Steam generators might also use thermal energy in the form of waste heat from another process.

Combustion can be defined as the rapid chemical combination of oxygen with the combustible elements of a fuel. There are just three combustible chemical elements of significance: carbon, hydrogen and sulphur. Sulphur is usually of minor significance as a source of heat.

Carbon and hydrogen, when burnt to completion with oxygen, are transformed to CO₂ and H₂O according to the following reactions:

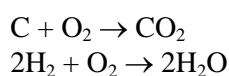

Air is the usual source of oxygen for boiler furnaces. These combustion reactions are exothermic and the heat released is about 32 800 kJ/kg of carbon burnt and 142 700 kJ/kg of hydrogen burnt. The energy of fuels cannot be calculated by the sum of energy from the hydrogen and carbon content alone, as the chemical energy of molecular formation also needs to be taken into account. Also sulphur and other elements in the fuels contribute to the energy release. As water is released in a gaseous form during combustion, the heat transferable to the steam generator is the theoretical heat of combustion minus the latent heat of the water vapour of the flue-gas. This energy is expressed as the 'lower heating value' (LHV) or 'net calorific value'. The LHV can be compared to the 'higher heating value' (HHV) or 'gross calorific value', which is defined for all the combustion products at environmental conditions (1 bar, 25 °C) and takes into account the latent heat of vaporisation of water in the combustion. Most of the additional energy is only available with the condensation of gaseous H₂O from the flue-gas to liquid H₂O at temperatures below the water dew point.

The objective of good combustion is to release all of this heat, whilst minimising losses from combustion imperfections and superfluous airflows. Proper combustion requires a temperature high enough to ignite the constituents, good mixing or turbulence, and sufficient time for complete combustion.

In a boiler furnace (where no mechanical work is carried out), the heat energy derived from the reaction of the combustible elements with oxygen depends on the ultimate products of combustion and not on any intermediate combinations that may occur in reaching the final result.

A simple demonstration of this law is the reaction of 1 kg of carbon with oxygen to produce a specific amount of heat. The reaction may occur in just one step to form CO₂ or, under certain conditions, it may occur in two steps: firstly forming CO, which produces a much smaller amount of heat, and secondly through the reaction of the CO to form CO₂. However, the sum of the heat released in the two steps is the same as the 32 800 kJ/kg generated when carbon is burnt in the single step to form CO₂.

The fact that carbon can react in these two ways with oxygen is of the utmost importance in the design of combustion equipment. Firing methods must assure complete mixture of the fuel and oxygen to be certain that all of the carbon burns to CO₂ and not to CO. Failure to meet this requirement will result in appreciable losses in combustion efficiency and in the amount of heat released by the fuel, since only about 28 % of the available heat in the carbon is released if CO is formed rather than CO₂.

2.2 Common technical combustion processes

The chapter is intended for those interested in gaining a general understanding of the industry and for those interested in the interrelationship between industrial processes and the topics described in subsequent sections.

2.2.1 General fuel heat conversion

In this section, information is only given as a summary to provide an overview of different combustion techniques. Where necessary, the specific combustion processes are given in more detail in the relevant fuel chapters. Combustion techniques are generally applied at about atmospheric pressure, but can be developed for higher pressure. In all combustion systems, almost 100 % of fuel energy is converted to heat. This conversion efficiency is called ‘fuel utilisation’.

Generally in most applications, this released net fuel heat is transferred to, and applied in, steam processes, gas turbines or reciprocating engines. The unburnt carbon-in-ash, CO, and VOCs contains the losses of fuel energy during the combustion process.

In gasification processes for solid or liquid fuels, heat is released in two steps: in a first step when the fuel is gasified, and in a second step when the product gas is burnt.

The choice of system employed at a facility is based on the loads, the availability of the fuels, and the energy requirements. Facilities using these systems also need other ancillary processes. These ancillary processes include supporting operations such as coal processing and pollution control. [131, EPA 1997]

2.2.2 Pulverised and atomised firing

Boiler types

There are two types of furnaces/boilers where the solid fuels are pulverised or the liquid fuels are atomised before combustion:

- **Dry bottom ash furnace/dry-bottom boiler (DBB):** This type of boiler is operated at temperatures far below the melting point of the ash. To avoid slagging, the ash temperature is low enough not to stick to the walls, and ash collected at the bottom is solid. In the centre of the flame, temperatures are often higher than the melting point of the ash particles and the temperature at the furnace outlets is much lower compared to the flame temperature, ensuring a solid, non-sticky state of the particles. From 0 % to 20 % of the ash is transferred to the dry-bottom of the boiler and is extracted as bottom ash, the remaining 80–100 % of the ash is transported with the flue-gas and then removed downstream. The DBB technique has the highest installed capacity of coal combustion in the world. New plants using this technique with single unit capacities of up to 1 100 MW_e are in operation for lignite combustion in Europe. In the US and Japan, units have been built with even higher capacities for coal combustion.
- **Slag tap furnace/wet-bottom boiler (WBB):** This type of boiler is operated at temperatures above the melting point of the ash to ensure a liquid ash with sufficient fluidity to flow down the protected walls. The liquid ash is quenched in a water-filled collector. These furnaces need special ceramic lining to withstand the molten ash temperatures and high-temperature chemical attack. A large amount of ash is transported to the walls and flows in a liquid form down the walls and through the bottom outlet. Fly ash in this type of combustion system can be recycled to the combustion chamber to produce boiler slag as a residue instead of fly ash. The wet-bottom boiler is mainly used for the combustion of coal (e.g. anthracite), where the amount of volatiles is relatively low. Waste co-incineration is often relatively easy in slag tap furnaces.

Firing systems

In pulverised/atomised fuel firing, the fuel gas mixture is injected via nozzles into the combustion chamber and burnt with combustion air. Separate ignition/pilot burners are used during start-up, for unstable combustion situations and/or for shutdown. These burners are supplied with fuel oil ignition/support feed in most cases, but can also use natural gas or finely ground dry lignite. Different coal burner configurations for coal and lignite boilers are shown in Figure 2.1.

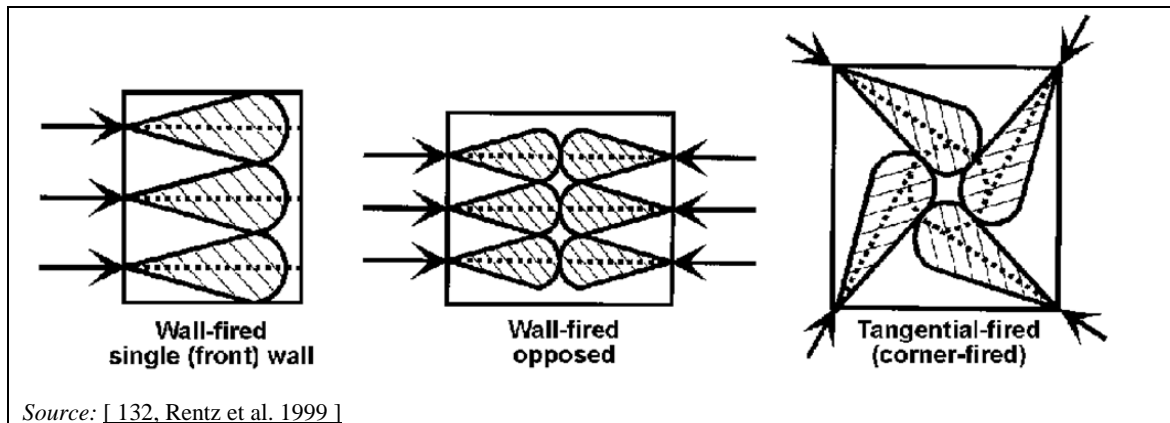

Figure 2.1: Different coal burner configurations (main systems applied)

- **Wall- or front-fired systems:** In horizontally wall-fired systems the burners are located in rows, either on the front wall only or on both the front and rear walls. The latter is called ‘opposed firing’.
- **Tangential- or corner-fired systems:** In tangential- or corner-fired systems, the burners are located in each of the four corners of the furnace. The burner nozzles are directed so that the streams of coal and air are projected along a line tangent to a small circle, lying in a horizontal plane, at the centre of the furnace. A rotative motion, similar to that of a cyclone, is imparted to the flame body, which spreads out and fills the furnace area. The ignition at each burner is aided by the flame from the preceding one. In many cases, the windbox nozzles can be automatically tilted to control the furnace exit-gas temperature, to maintain the heated or reheated steam at the system design temperature. A corner-firing system is always a tangential-firing system, but a wall-firing arrangement can also be built as tangential-firing system. Figure 2.2 shows an example of a tangential-fired combustion chamber.

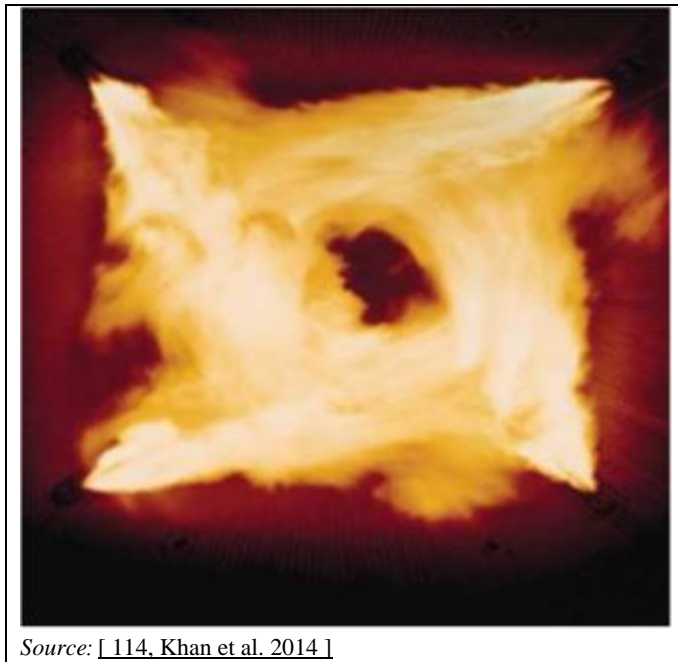

Figure 2.2: Tangential-fired combustion chamber

- **Vertically fired systems:** The first pulverised coal systems had a configuration called vertical or arch. They are now principally used to fire coals with volatile matter of between 8 % and 15 % (dry basis). The firing system produces a long, looping flame in the lower furnace with the hot gases discharging up the centre.

Boilers designed for burning **liquid and gaseous fuels** are very similar to boilers that are used for the combustion of coal. While gaseous fuel is directly combusted with air, liquid fuels are sprayed into the furnace via nozzles, generating very small droplets atomised by high-pressure steam or air and producing a high amount of volatiles. Only heavy fuel oils produce significant amounts of ash. All clean gaseous and liquid fuels can be fired by burners at the bottom of the furnace.

A typical heavy fuel oil boiler is shown in Figure 2.3.

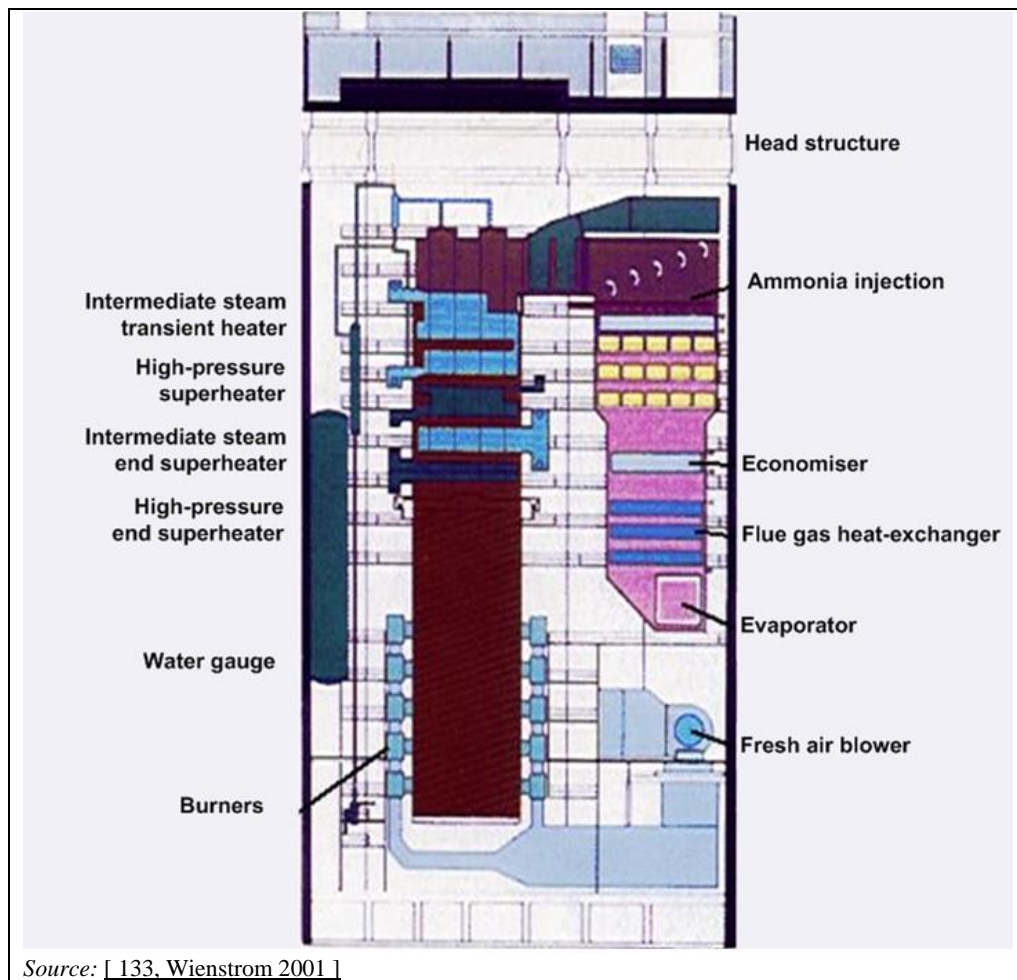

Figure 2.3: Heavy fuel oil boiler

All burner designs are supplied directly with air.

When designed for **gas burning** only, the combustion chamber is slightly smaller but, in most cases, these boilers are designed to also burn liquid fuel in emergency situations or for multi-fuel firing.

2.2.3 Fluidised bed combustion

Fluidised bed combustion takes place with the injection of fuel into a hot turbulent bed formed of inert material and ash, where primary combustion air has also been injected from the bottom of the fluidised bed boiler for fluidisation of the bed.

Sand is normally used in the first bed material for the first start-up of the boiler. The bed of particles, including fuel (between 1 % and 3 % of the bed material), ash and sorbents, is fluidised by upwards flowing air and flue-gas in a furnace. Due to the combustion temperatures of about 850 °C and the long residence time, the burnout of the fuel is very high and, therefore, the related emissions of combustion products are relatively low.

For this FBC type of furnace, solid fuel generally has to be coarsely milled, as fine particulates would be blown out of the fluidised bed, and excessively large particulates would stop fluidisation.

Small units operate at static fluidisation. With growing boiler sizes and with low reactive fuels, the application of circulating fluidised bed combustion is preferred. To utilise the whole

furnace, volume particulate extraction, cyclone separation and the recycling of coarse particles to the bed are integral to the concept. A few pilot FBC plants are operated at higher pressures, integrating a gas turbine for flue-gas expansion. These systems are called pressurised fluidised bed combustion (PFBC) systems. Despite technical problems faced in the development period of this system, a few plants are operating today.

Currently two different types of fluidised bed boilers exist: bubbling fluidised bed combustion (BFBC) and circulating fluidised bed combustion (CFBC). Figure 2.4 shows a scheme of both types of fluidised bed boilers. Fluidised bed combustion is used for industrial and power applications where different solid fuels such as coal, lignite, peat and particularly biomass are burnt.

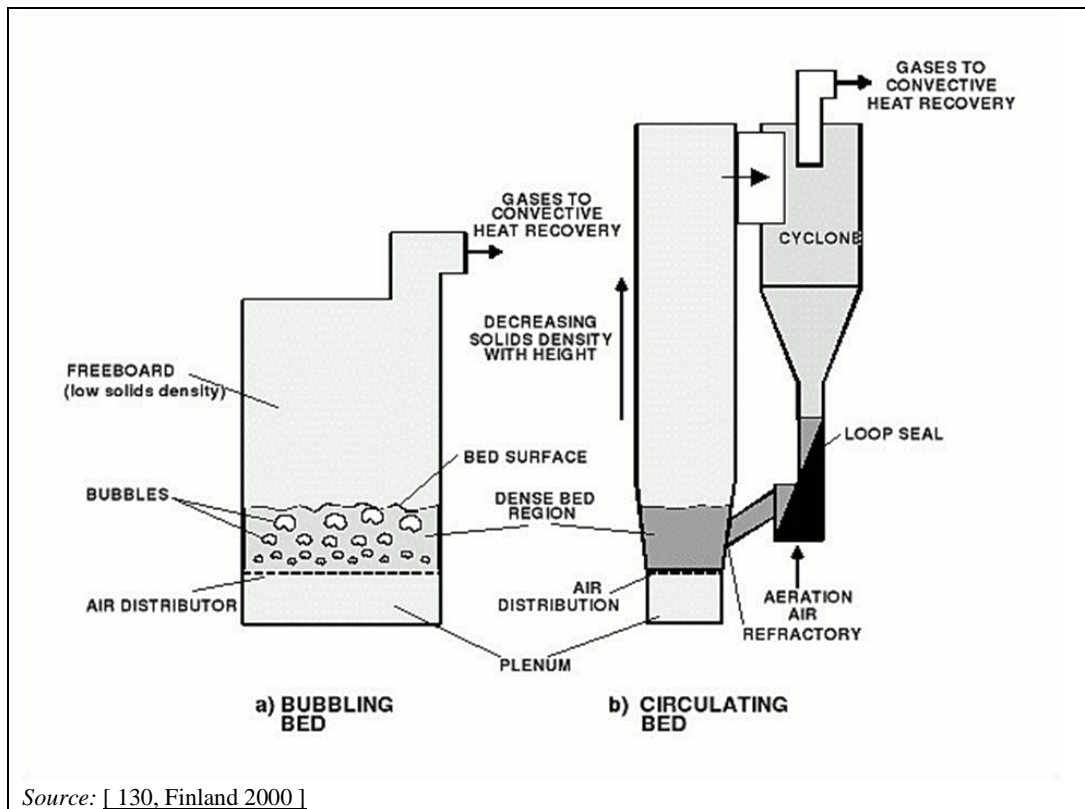

Figure 2.4: Schematic of the bubbling fluidised bed boiler and the circulating fluidised bed boiler

Fluidised bed combustion is not very different from other combustion techniques. Bubbling fluidised bed combustion resembles spreader stoker grate firing in many respects. The main benefit for combustion is the better temperature control. Circulating fluidised bed combustion resembles pulverised fuel combustion or burner combustion. One difference though is the comprehensive temperature control of the furnace, which ensures ignition of the fuel without the need for a high-temperature flame.

The temperature of a fluidised bed is typically 750–950 °C. The lower limit comes from the combustion reactivity of the fuels, and the upper limit from the starting point of the fuel ash sintering.

Fuel does not need to be pulverised or dried for use in fluidised bed boilers. Mechanical crushing of the fuel is sufficient to facilitate its feeding into the bed. Fluidised beds can tolerate high moisture content because of the stabilising effect of the bed. Some size limitations are connected with the rotary fuel feeders. On the other hand, the pre-processing of reactive fuels is safer if they contain a moderate amount of moisture. The risks of explosive dust formation and

fires in fuel processing and transportation are normally controlled by keeping the fuel moisture content above 40 %.

As far as environmental considerations are concerned, FBC systems are able to reduce SO_2 emissions by limestone injection and can achieve a relatively low level of thermal NO_x formation because of the low combustion temperature. This is one of the reasons why this combustion technique is being intensively developed more and more nowadays. Moreover, a wide range of fuels can be combusted in the same facility because these boilers are not very sensitive to the fuel specifications.

In the bubbling bed freeboard above the bed itself, the combustion of the pyrolysis gases can produce temperatures in excess of $1\,200\text{ }^\circ\text{C}$ and this can promote the formation of thermal NO_x . As a general rule, NO_x formation in a properly designed fluidised bed can be kept below the NO_x formation in PC boilers.

The fluidised bed combustion option is a balancing act between the partially conflicting requirements of NO_x , N_2O , and SO_2 control, and the control of unburnt hydrocarbons, CO, and char.

Fuels with a low ash melting point cannot be burnt in a fluidised bed, because the fluidisation will be disturbed quite rapidly by the accumulation of melted ash. Heavy physical impurities such as metal particles in domestic waste cannot be fluidised either, as they sink onto the air distribution plate, disturb the fluidisation, and are difficult to remove from the furnace. However, new solutions for keeping the bed operational with these fuels have been successfully implemented.

2.2.3.1 Bubbling fluidised bed combustion (BFBC)

Bubbling fluidised bed combustion (BFBC) is a modern combustion technology, especially suited for burning inhomogeneous biofuels. In BFBC, the fuel is fed into the bed. Biofuels pyrolyse instantly once in contact with the hot bed. Of the combustion air, 30–40 % is used as the fluidising air and the rest is used for the combustion of pyrolysis gases in the so-called freeboard above the bubbling bed. Most of the finest particles also burn in the freeboard. The combustion temperature in the freeboard can be up to $1\,100$ – $1\,200\text{ }^\circ\text{C}$, or even higher locally. The bubbling bed actually operates as an adiabatic combustor of fuel, and the low combustion temperature is a result of using a substoichiometric air ratio in the primary combustion zone.

BFBC consists of a 0.5–1.5 m high bed on a fluidising air distribution plate. The fluidising velocity is about 1 m/s. The density of the bubbling bed is about $1\,000\text{ kg/m}^3$. Typical bed materials used are sand, fuel ash, dolomite, limestone, etc. The particle size distribution in the fluidising bed material is typically within 0.5–1.5 mm, as smaller particles are carried out with the fluidising gas flow, and larger particles sink onto the distribution plate. The left of Figure 2.5 shows how the furnace of a BFB boiler, marked light blue, with the fluidised bed at the bottom, is wide to keep the gas velocities low enough for the fluidised material to stay in the furnace.

In the freeboard of the BFBC furnace, other burners can be located and operated simultaneously with the bed. For example gas, oil and coal burners have been used.

2.2.3.2 Circulating fluidised bed combustion (CFBC)

Circulating fluidised bed combustion (CFBC) differs from BFBC in two ways. The bed material particle size is smaller, i.e. 0.1–0.6 mm, and the fluidising velocity is faster, i.e. 4–6 m/s. These changes affect the fluidising conditions so that part of the bed material is carried out from the bed, transiting through the furnace to the second pass of the boiler. These particles are separated

from the flue-gas flow by a cyclone or by other separation methods and recirculated back to the fluidised bed. The separation can be carried out in the middle of the second pass and, in part, at the outlet of the boiler pass, where electrostatic precipitators and bag filters can also be used.

In CFBC, air is blown into the bottom of the furnace, partly as primary air injected through a grid and partly as secondary air some metres above the grid. The velocity of the air is high enough to carry the bed solids along with it, thereby filling the entire combustion chamber. The hot combustion gases carry the particles to the top of the combustion systems and into heavy-duty cyclones or other separation units, where they are separated and recirculated back into the bottom of the main combustion chamber as is represented on the right side of Figure 2.5. To enable SO₂ removal, crushed limestone or dolomite is added to the bed. The circulating bed systems increase the reaction time and the level of gas mixing, therefore generally leading to a more efficient combustion and fixation of sulphur.

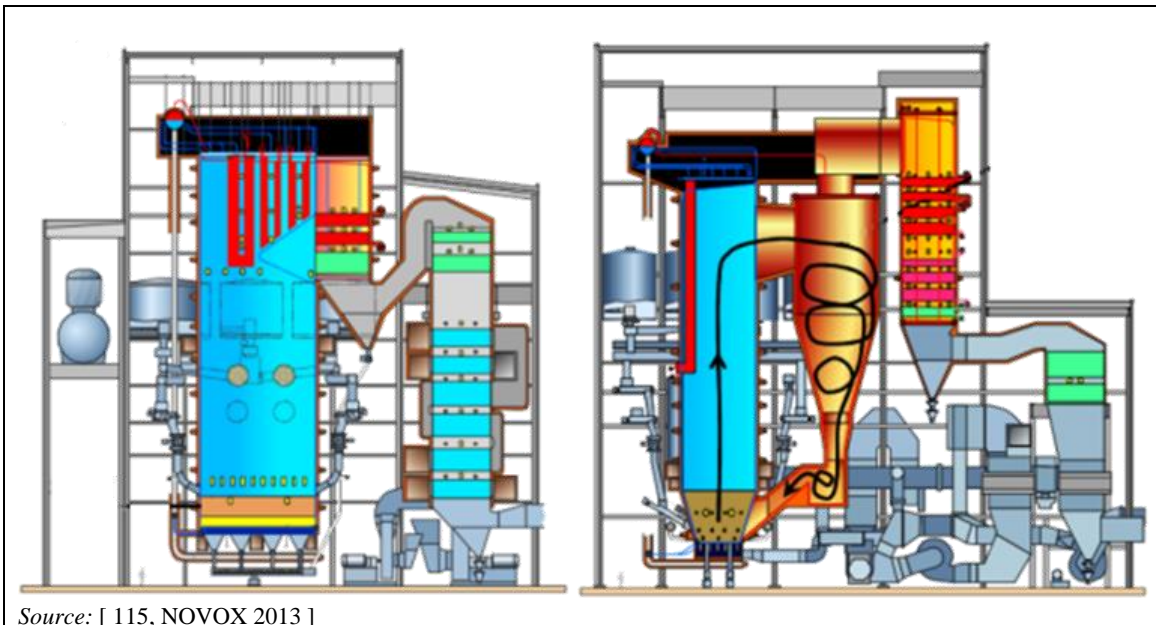

Figure 2.5: BFBC boiler (left) and CFBC boiler (right) schemes

CFBC includes a bubbling fluidised bed at the bottom of the furnace. The suspension density above the bed decreases with furnace height, as the bed material is recycled in the furnace along the furnace walls. This high share of circulating inert material smoothes the temperature profile throughout the furnace. The heat transfer surfaces therefore can be located at different places in the furnace or in the bed material circulation loop. In the furnace, heat is transferred very evenly to all heat transfer surfaces, because the heat radiation of the dense suspension is not dependent on the radiation properties of the flue-gases.

A cyclone is the most common solids separation method used in CFBC boilers. Experience from existing CFBC plants have shown that cyclone efficiency is a crucial parameter for the proper functioning of the whole CFBC system. The cyclone efficiency has a major impact on the carbon burnout, limestone consumption, SO₂ and CO emissions, and the temperature profile. The cyclone efficiency is mainly important for fuels such as low reactive fuels and fine grain fuels (coal slurry), because the better the cyclone efficiency, the longer the char particles are kept in the furnace and less furnace inventory is lost via the cyclone.

The increase in cyclone efficiency greatly enhances the solid circulation rate, thus ensuring a constantly high heat transfer in the furnace. Thus, the most favourable conditions for low NO_x and low SO_x emissions can be reached for a wide fuel range and load range. Optimisation of the cyclone design is a key issue for good performance of a CFBC boiler.

Supercritical CFB boilers have exceeded 450 MW_e since 2009 and 600 MW_e since 2014 (Baima, China). Most boiler suppliers are able to develop CFB plants up to 900 MW_e.

The latest developments of CFBC plants have been focusing on the low-emission combustion of a broad range of coals, including poor quality bituminous coal with high sulphur and high ash contents, but also low-ash anthracites and low-calcium lignite. Other objectives have been to cut operating costs (mainly limestone and ash disposal costs). Furthermore, different steps to increase plant efficiency and to reduce CO₂ emissions have been developed, e.g. introducing super-critical CFB technology (Figure 2.6) and further expanding the capabilities to combust difficult coals (Figure 2.7).

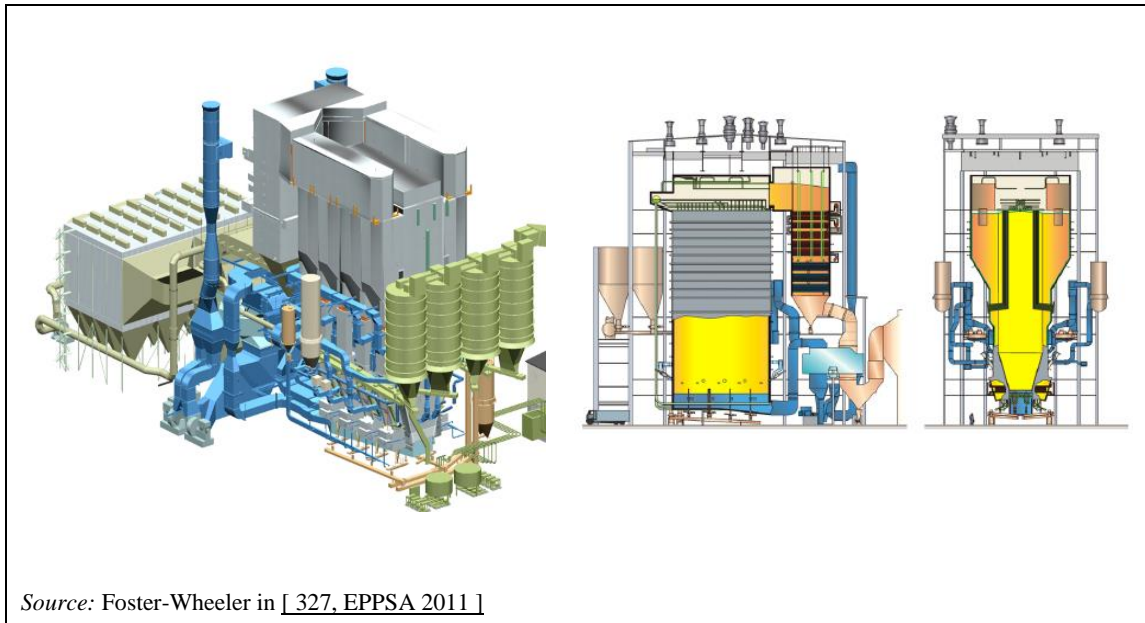

Figure 2.6: CFBC plant for high efficiency (Lagisza, 966 MW_{th}, 361/306 kg/s, 275/50 bar, 560/580 °C)

Figure 2.7: CFBC plant for low-quality lignite (Turow, 3 x 557 MW_{th}, 195/181 kg/s, 170/39 bar, 568/568 °C)

2.2.3.3 Pressurised fluidised bed combustion (PFBC)

Based on the experience gathered with atmospheric fluidised bed combustion systems, the development of pressurised fluidised combustion (PFBC) started in the mid-1970s. The technology is a combination of the Rankine steam cycle and Brayton gas turbine cycle. PFBC systems offer the advantage of smaller plant sizes than conventional FBC plants for the same output. Because of the low combustion temperature, no thermal NO_x is formed, and fuel NO_x can be reduced during combustion by the introduction of ammonia into the freeboard or into the flue-gas duct. As in the case of atmospheric FBC, it is possible to differentiate between bubbling and circulating bed systems. PFBC plants were commissioned in the 1990s and the early 2000s.

The main parts of a PFBC system are: the fuel preparation and handling section; the pressurised bubbling or fluidised bed boiler; the flue-gas clean-up section; the gas turbine (including the gas turbine expander and the air compressor); and the steam/water circuit of the steam turbine. Figure 2.8 shows a schematic drawing of a bubbling bed PFBC system.

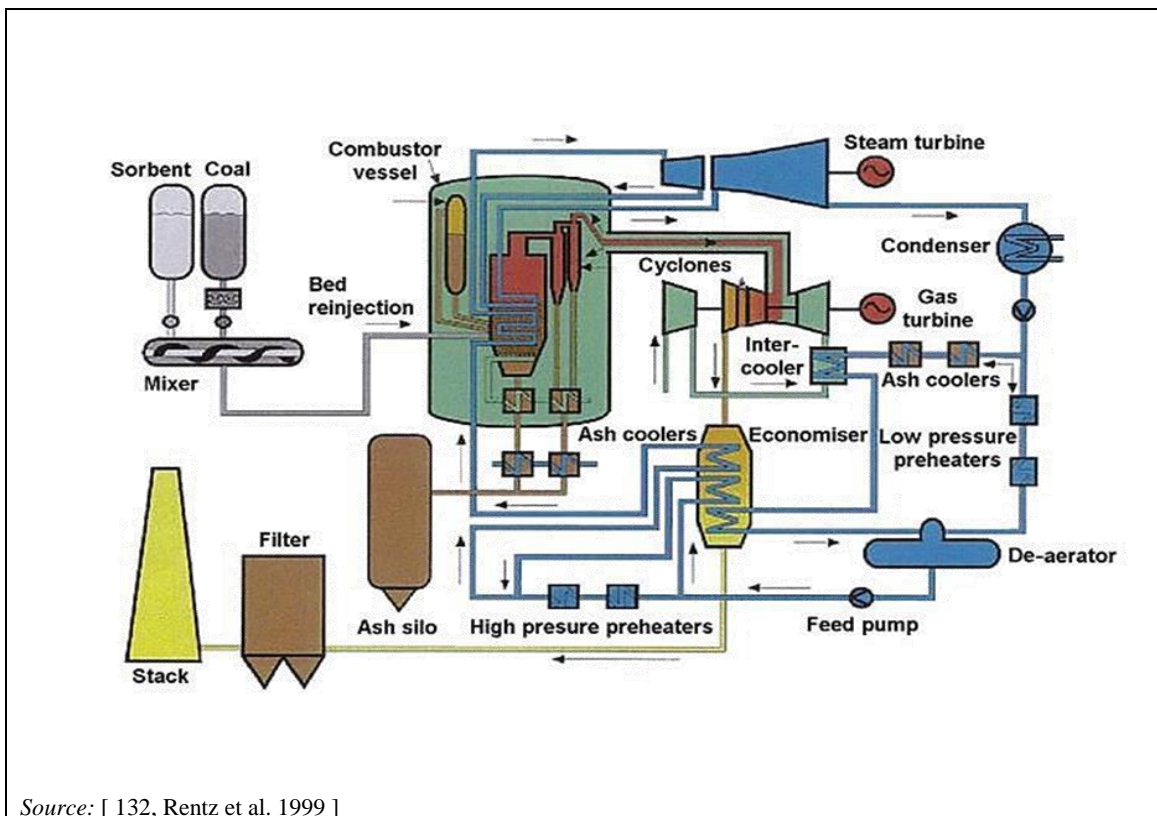

Figure 2.8: Schematic drawing of a bubbling bed PFBC system

In the scheme shown in Figure 2.8, coal is crushed and then mixed with limestone (dolomite). The mixture is fed via a pneumatic conveying system or a slurry feed pump across the pressure boundary and is then injected into the combustor from a series of feed points. Combustion air is first pressurised using a suitable gas turbine compressor and routed to the combustor containment vessel through the outer annulus of a coaxial duct, while hot combustion gases return to the turbine through the central passage. Combustion takes place inside the pressure vessel at a temperature of $850\text{ }^{\circ}\text{C}$ to $900\text{ }^{\circ}\text{C}$ and a pressure of approximately 1.6 MPa . The combustion chamber is equipped with immersed heat exchangers, which allow for a constant combustion temperature and which produce high-pressure steam, which is utilised in the steam turbine. The hot flue-gases are first cleaned using ceramic candle filters or cyclones and then expanded through a gas turbine connected to the air compressor and a generator. A Brayton cycle gas turbine expander drives the air compressor supplying air required for the combustion

process. Turbine exhaust gases are fed to a heat recovery steam generator and are used for boiler feed-water preheating and steam generation. The steam turbine produces about 80 % of the total electricity produced by the utility.

Currently, PFBC systems are able to achieve thermal efficiencies of up to 45 %. Further improvements are limited because of the comparatively low gas turbine inlet temperature, which is determined by the combustion temperature in the fluidised bed boiler. Several process schemes to increase the gas turbine inlet temperature, e.g. by an additional firing using natural gas or fuel oil, or by partial gasification of the feed coal prior to combustion and utilising the fuel gas in the gas turbine, have been proposed and are being investigated. These process configurations offer considerably higher efficiency values, but no pilot or demonstration plant has yet been built. As mentioned earlier, inherent emission control is one of the main features of PFBC technology. [132, Rentz et al. 1999]

2.2.3.4 NO_x and N₂O control in fluidised bed combustion

The formation of thermal NO_x is low in fluidised bed combustion because of the low combustion temperature. Most NO_x formed in FBC boilers is generated from the nitrogen content of the fuel, and is efficiently controlled by staging the combustion air. The staging in CFBC is always quite strong because of the poor horizontal mixing of gases over a dense suspension area. The dense suspension suppresses the turbulence, and the combustion zone of volatile fuel components spreads upwards from the feeding point. Staging of combustion air can also be implemented in BFBC.

Fuel nitrogen can also form nitrous oxide (N₂O). N₂O emissions are higher from FBC boilers than from PC boilers. The share of fuel nitrogen that forms nitrous oxide decreases to an insignificant value if the bed temperature is increased to over 950 °C. On the other hand, a high combustion temperature can cause an increase in the emissions of nitrogen oxides (NO and NO₂). In BFBC, the risk of nitrous oxide emissions can be more easily avoided, as the temperature in the freeboard can be kept much higher than 950 °C.

2.2.4 Grate firing of solid fuels

Grate firing is the oldest firing principle used in boilers. Today grate-firing systems are highly developed and moving grates are typically used in these systems. Depending on the particular fuel characteristics, moving grates are arranged in a horizontal position (e.g. travelling grate systems) or in a sloped position (e.g. pusher-type grate systems or vibrating grates). Moving grate systems burn solid fuels on the grates with air passing through the system floor. Normally there is only limited fuel preparation needed. Large pieces of solid fuel may be reduced in size in order to supply a more or less homogeneous particle size distribution into the combustion chamber for burning on the grate. The maximum size of the fuel particles is often determined by the feed systems for the combustion chamber and depending on the technical conditions of the grate.

Grate or spreader stoker combustion systems burn solid fuels on the grate or stoker system with air passing through the system floor (see Figure 2.9). Most coarse solid fuels can be burnt in these systems. On a mass-burn grate, the fuel is initially dried and then pyrolysed as it moves along the grate and finally the char is burnt and the ash is discharged at the end of the grate. In spreader stoker firing, part of the fuel burns in suspension. The heavier fuel particles land on the grate and burn more or less uniformly across the grate surface.

The combustion process in grate firing is not as well controlled as it is in pulverised fuel burners or in fluidised beds. The combustion chemistry and the temperature can vary even for the same kind of fuel particles, depending on their location on the grate. On a grate, all fuels will first be dried, then pyrolysed and, finally, the char is burnt on the grate. The pyrolysing share of fuel

energy can be about 80 % with biofuels. Modern grate-firing control enables an optimal burning air supply and, therefore, a low content of unburnt compounds in the flue-gases.

Practice shows that fuel can be fed as a mixed size grading, usually from 30 mm downwards, including very fine particles. Grate combustion systems work with a steady reservoir of fuel in the combustion chamber, but the fuel can be left on the grate without the fans running, and can be rekindled quickly in the event of sudden demand for steam. If problems arise with the air supply, a bypass operation is necessary. Grate firing is a technology applied for coal- and biomass-fired boilers used for heat inputs up to 150 MW, mainly applied in industrial and local district heating plants.

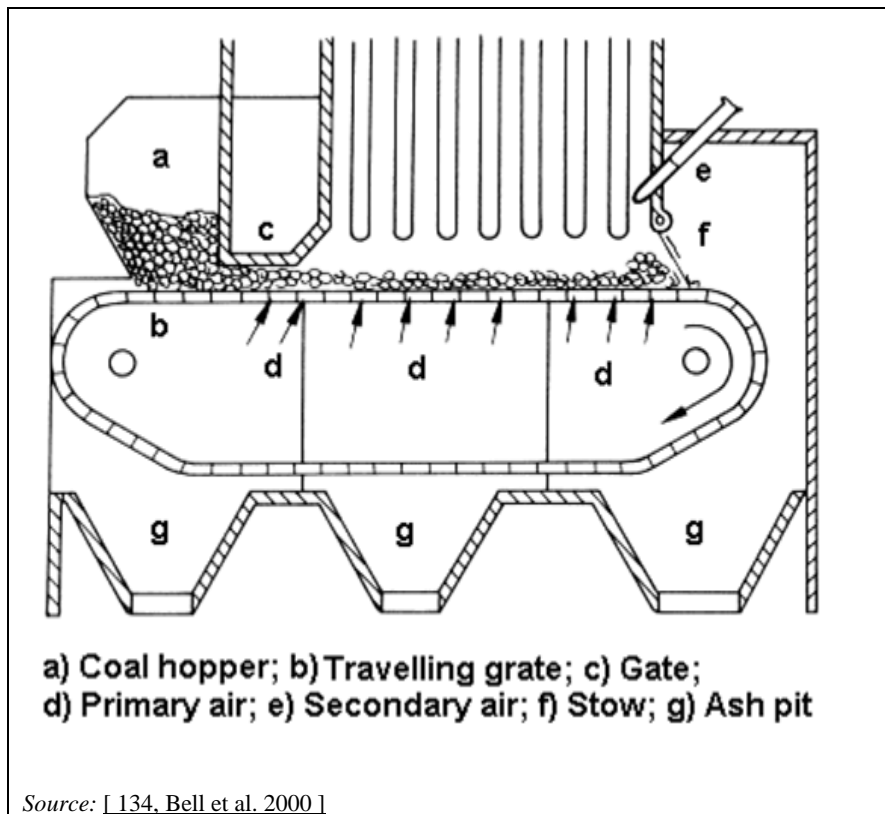

Figure 2.9: Travelling grate firing for coal combustion

In the spreader stoker system, the fuel can also be fed onto the grate by a so-called spreader located on the furnace wall (see Figure 2.10). The spreader throws the fuel on the grate against the direction of the grate movement. Thus, the longest burning time can be achieved for the largest particles, as they are thrown furthest from the ash discharge.

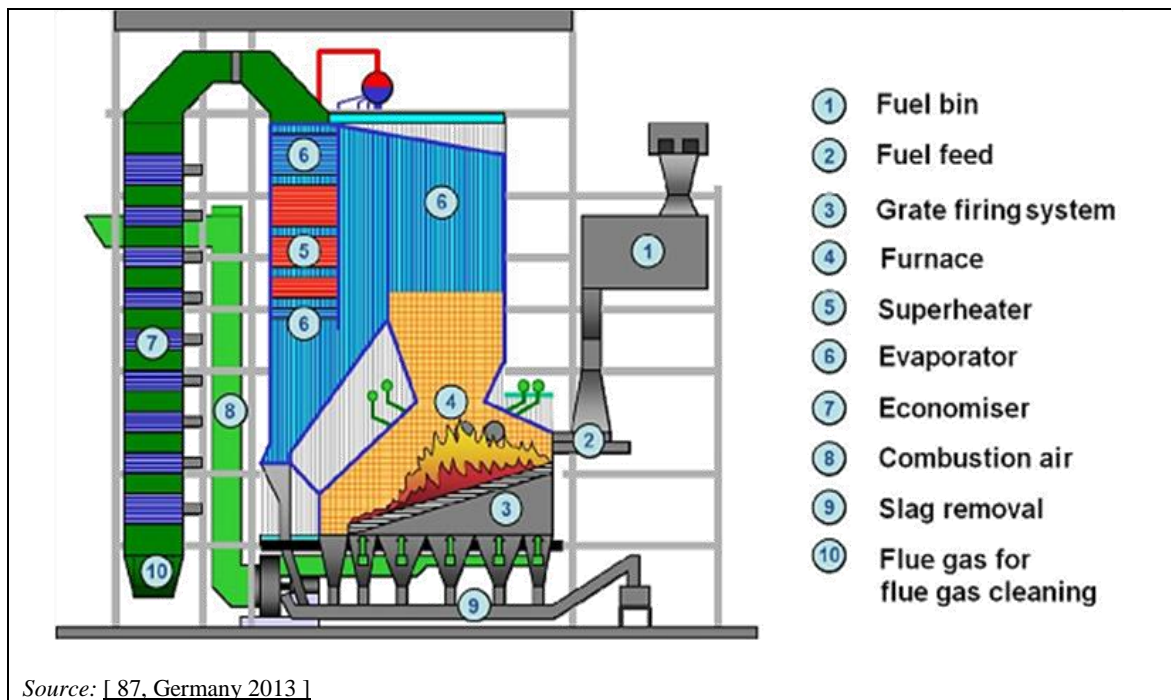

Figure 2.10: Spreader stoker grate firing for solid fuels

2.3 Direct conversion

2.3.1 General

The expansion of hot pressurised (flue-) gas in gas turbines and in internal combustion engines allows the generation of mechanical and, subsequently, electrical energy. Such systems have been developed from mobile systems and are often applied in remote sites, like islands, or in gas transmission networks. The transfer of combustion heat at a high temperature to steam with exergetic losses caused by temperature limitations is avoided in these processes. For this reason, interest in direct expansion methods is increasing. These systems can be started very quickly and so can meet peak demands. Additionally, these technologies do not necessarily need water for cooling. Nonetheless, they can be coupled to steam processes to increase the overall efficiency, i.e. in a combined cycle.

2.3.2 Combustion engines

Combustion or reciprocating engines have one or more cylinders in which fuel combustion occurs. Engines convert the chemical energy of fuels into mechanical energy, in a design similar to a marine engine (HFO and/or gas oil engine type) or automotive Otto (lean-burn gas engine type) engine. To produce electricity, the moving piston transfers the energy from the combustion to a generator connected to the rotating engine shaft.

Reciprocating engines for power plants are typically designed to operate on either four- or two-stroke cycles. Both larger baseload engine-driven power plants with an output of up to about 600 MW_e (formed by a number of single engines) and decentralised smaller simultaneous heat and power (CHP) production plants are common worldwide. High-efficiency medium- and low-speed engines are suitable for baseload operation. Medium-speed diesel engine units with a fuel input of up to 50 MW_{th} or more and gas diesel engines ('high pressure' and 'low pressure (dual fuel)' types) with a fuel input of up to 40 MW_{th}, are available on the market. Low-speed diesel engine units have a fuel input of 130 MW_{th} or more. Four-stroke spark-ignited lean-burn gas-type engine units have a fuel input of up to about 45 MW_{th}. [135, Wärtsilä 2000.]

Compared to gas turbines, combustion in reciprocating engines is not continuous and takes place in closed combustion chambers. During combustion, the pressure and temperature increase is very high and this allows a high conversion efficiency for small units. Most systems use gas oil or heavy fuel oil as liquid fuel, but gaseous fuel use is also possible. Often special measures are necessary to reach current emission standards.

In Europe, few such plants exist in interconnected systems for power generation with liquid fuels. The applications with liquids are mainly limited to isolated systems (e.g. operated on islands) where a natural gas grid is not available. Gas-fired stationary engine plants are common today, such as medium-sized CHP plants and large peaking plants for grid stabilisation.

The advantages of the reciprocating engine for this kind of application are many, e.g. high thermal efficiency (low fuel consumption), optimum set-up for matching different load demands, short construction time, easy maintenance and robust design. The best electrical efficiencies (at alternator terminals) range from about 38 % to 48 % (depending on the engine size, and depending on whether it is a new engine and/or whether it is single or combined cycle), calculated on the lower heating value of the fuel.

Other attractive advantages of the engine-driven combustion plant are that these combustion plants can be located in urban areas or in industrial areas close to the consumers of the heat and electricity. Less transmission lines are then needed and the associated energy losses and land demand can be minimised. Engine-driven CHP plants are well suited for industrial applications, local utility companies, residential and commercial buildings, etc. Heat can be recovered as steam, hot water, hot air, etc. Possible options for using the recovered heat include:

- district heating/cooling;
- desalination processes;
- air preheating for some processes.

2.3.2.1 Diesel engines

Diesel engines are flexible in terms of fuel and can use fuels such as gas oil, heavy fuel oil, gas, crude oil, biofuels and, in a few cases, even emulsified fuels. In a diesel engine, air is forced into the cylinder and is compressed by the piston. Fuel is injected into the cylinder and is ignited by the heat of the air compression.

The optimum heat to power ratio for a reciprocating engine plant is typically about one (in a high-grade heat plant), compared to a low-grade heat system which typically has a heat to power ratio of 3/2 or higher.

Liquid fuel pressure can be boosted to about 1 100–1 800 bar (dependent on engine type) to achieve a droplet distribution small enough for fast and complete combustion. The nozzle design for the fuel inlet is one of the key factors for the combustion process. Combustion is realised partially at constant volume with an increase in the pressure, with the main combustion process occurring at constant pressure. Combustion is not continuous but occurs only during one part of the cycle. End-of-compression pressure and temperature are important parameters to ensure good combustion. The maximum pressure must be limited to prevent damage. The engine materials can bear temperatures of about 1 200 °C, which allows a maximum cycle temperature of 2 500 °C. Thus the efficiency of this kind of engine is around 40–50 %.

2.3.2.2 Spark-ignited (SG-type) engines

A spark-ignited gas Otto engine often works according to the lean-burn concept. The expression 'lean-burn' describes the ratio of air-combustion/fuel in the cylinder, which is a lean mixture, i.e. there is more air present in the cylinder than needed for combustion. In order to stabilise the ignition and combustion of the lean mixture, in larger engine types, a pre-chamber with a richer air/fuel mixture is used. The ignition is initiated with a spark plug located in the pre-chamber, resulting in a high-energy ignition source for the main fuel charge in the cylinder. This engine type is designed for use with low-pressure gas as a fuel. Spark-ignited engines with a fuel input of up to 40 MW_{th} are on the market.

2.3.2.3 Low-pressure dual fuel (DF-type) engines

The dual fuel (DF) engine is an engine type that recently became available on the market, developed for countries where natural gas is available. This engine type is versatile with regards to fuel, it can be run on low-pressure natural gas or liquid fuels such as gas oil, heavy fuel oil, bio oils, etc., and it can operate at full load in both fuel modes. In the gas mode, the engine is operated according to the lean-burn principle, i.e. there is about twice as much air in the cylinder compared to the minimum needed for complete combustion of the gas. This allows a controlled combustion and a high specific cylinder output without immediate risk of knocking or self-ignition when the process is well controlled. In gas engines, the compression of the air/gas mixture with the piston does not heat the gas enough to start the combustion process, and therefore some additional energy needs to be added, which is done by injecting a small pilot fuel stream (e.g. gas oil). A liquid fuel such as gas oil has a lower self-ignition temperature than natural gas and the heat in the cylinder close to the top position is enough to ignite the liquid fuel, which in turn creates enough heat to cause the air/gas mixture to burn. The amount of pilot fuel ranges from 1 % to 2 % of the total fuel consumption at full load. The engine works according to the diesel process, in the liquid fuel mode, and according to the Otto process in the

gas mode [136, EUROMOT 2001]. In view of the different thermodynamic cycles when operating a dual fuel engine, the engine cannot be optimised for each fuel and a level of compromise is inherent. The DF engine is primarily optimised for gas operation. Thus the compression ratio possible for a DF engine will be lower than for a modern diesel engine and, as a consequence, the NO_x emission is higher for the DF-type engine in liquid mode than for a modern optimised diesel engine if there is no NO_x abatement technique.

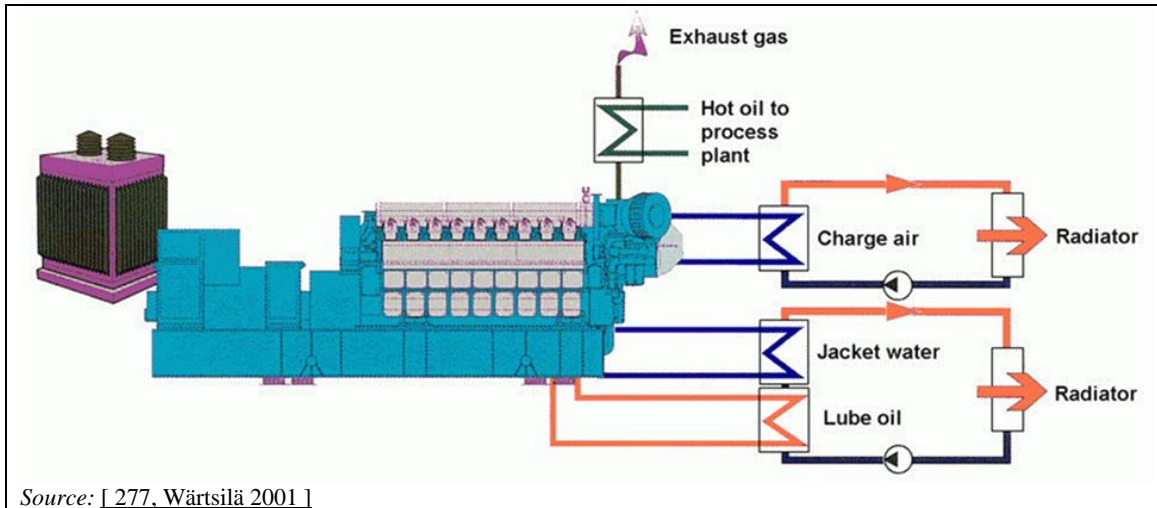

Figure 2.11: Natural gas-fired engine

2.3.2.4 High-pressure gas diesel (GD-type) engines

High-pressure gas injection engines operate according to the diesel process in both liquid and gas fuel modes. In the gas mode, a pilot fuel oil (e.g. HFO) (typically 3–5 % of the total fuel heat input) and a high-pressure gas at about 350–400 bar pressure are needed. The engine can operate at full load, both in liquid and gas fuel modes. High-pressure gas diesel engines up to about $40 \text{ MW}_{\text{th}}$ or 20 MW_{e} are available on the market.

2.3.3 Gas turbines

Gas turbines are used for the transformation of chemically bound fuel energy into mechanical energy. They are applied for the production of electrical energy and to drive pumps and compressors. The number of gas turbines used worldwide has grown significantly over the last decades, and nowadays gas turbines are increasingly used for electricity production in base and intermediate loads, and can also be used for emergency and peak demand, in large grids. In the case of islands, gas turbines operate with liquid fuel, mainly gas oil in medium or baseload operation. This increase may be explained by the abundant supply of natural gas at a favourable price in the past and by the development of a new generation of gas turbines with higher output, efficiency, and reliability.

Stationary gas turbines are classified into three groups according to their design characteristics and thermodynamic parameters:

- heavy-duty gas turbines;
- aero-derivatives (gas turbines derived from aircraft engines);
- small and micro-gas turbines for a decentralised power supply.

[1, Eurelectric 2012]

Gas turbines are used within a wide range of thermal capacities, from small gas turbines at about 100 kW_e, up to large gas turbines of 380 MW_e. Gas turbines can be fuelled with various gaseous fuels and liquid fuels. Natural gas is the usual gaseous fuel for gas turbines, but gases with low or medium calorific value are also applied, such as coal gas from coal gasification units, gas from blast furnaces, and gas from biomass gasification units. Heavy-duty gas turbines are capable of burning a variety of liquid fuels, from naphthas to residuals. Operating with ash-forming fuels, such as crude and residual oils, requires comprehensive treatment systems (e.g. desalting or particulates removal). The oil is raised to the necessary input pressure before combustion in the gas turbine.

Gas turbines are installed in different types of combustion plants, such as combined cycle units, cogeneration plants, and integrated coal gasification units (IGCC). Aero-derivative gas turbines are available up to 100 MW_e, with efficiencies of up to 42 %. They are also largely used on offshore platforms. Heavy-duty gas turbines with power outputs from 150 MW_e to 380 MW_e can reach efficiencies of up to 39 % (open cycle). Figure 2.12 shows examples of heavy-duty gas turbines from different manufacturers.

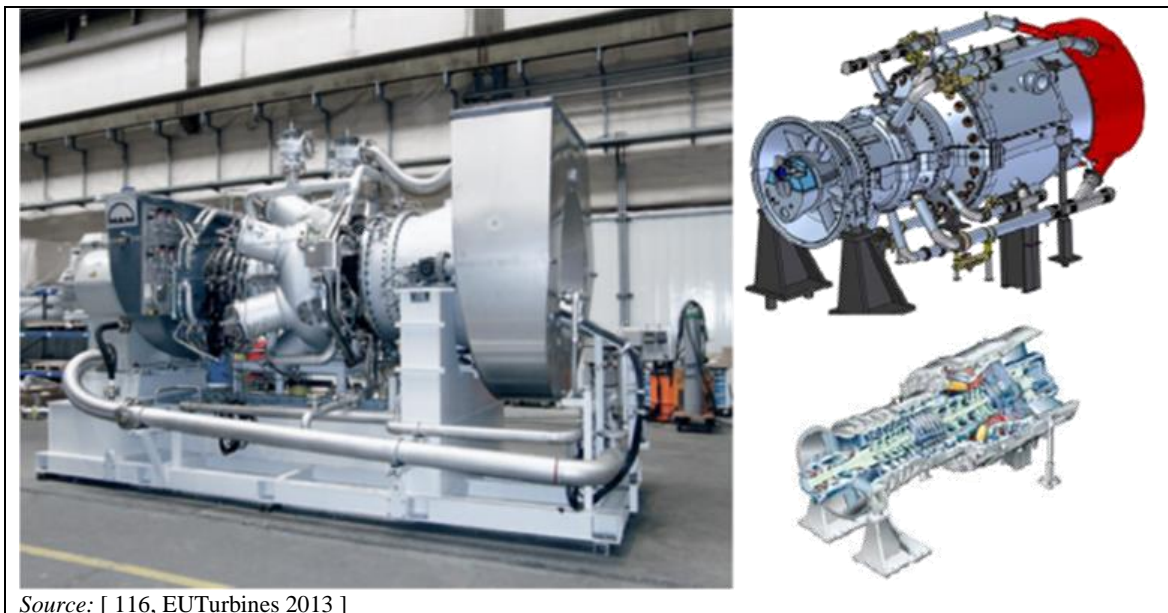

Source: [116, EUTurbines 2013]

Figure 2.12: Heavy-duty gas turbine electricity-generating units from different manufacturers

Sequential combustion, as shown in Figure 2.13, allows for a significant enhancement in heavy-duty gas turbines used in the simple cycle mode without a combined steam cycle. One advantage of these gas turbines is that the efficiency can be improved without constantly increasing the turbine inlet temperature, while the classical heavy-duty gas turbine process with high turbine inlet temperatures increases the complexity of the design of the downstream process, due to the high exhaust gas temperature.

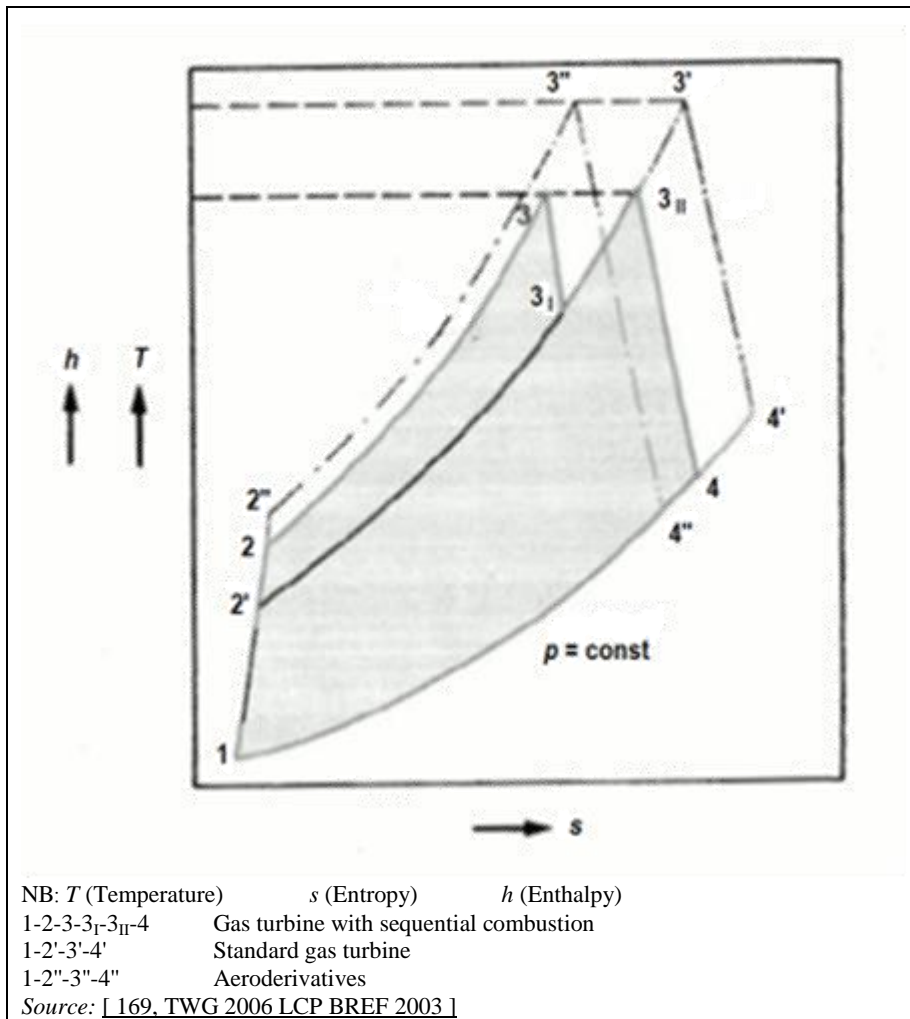

Figure 2.13: Scheme of a gas turbine process with sequential combustion

Figure 2.13 shows the scheme of a process with sequential combustion (1-2-3-3_I-3_{II}-4). The process pressure ratio (p_2/p_1), the turbine inlet temperature of both turbines (T_3 and T_{3II}), and the outlet temperature of the first turbine (T_{3I}) form three parameters which allow for setting an optimised gas turbine outlet temperature (T_4) in a combined process.

The classical heavy-duty process (1-2'-3'-4') with high turbine inlet temperatures (T_3) also generates very high exhaust gas temperatures (T_4), for which the design of the downstream steam process requires an increased complexity. It may be beneficial if the downstream cycle is designed for good exergy. An increase in the pressure ratio and turbine inlet temperature, which is possible in an aircraft engine and the derived gas turbines for power generation (aeroderivative gas turbine = 1-2''-3''-4''), leads to exhaust gas temperatures which are too low for an optimised combined operation. [1, Eurelectric 2012]

Gas turbines can be used in specialised cogeneration (CHP) plants. Industrial complexes can produce electricity on site when large heat to power ratios exist, i.e. ranging from 1.5 to 3.

Gas turbine systems are widely used to generate electric power. The turbines are gas and steam power plants, and peak load systems.

The open cycle gas turbine process is characterised by the relatively high temperature of the fluid flow discharged from the gas turbine. This energy may be partly used for instance to generate steam for operating steam cycle processes, as shown in Figure 2.14. This increases the fuel utilisation significantly by converting the open cycle gas turbine into a combined cycle gas turbine. [1, Eurelectric 2012].

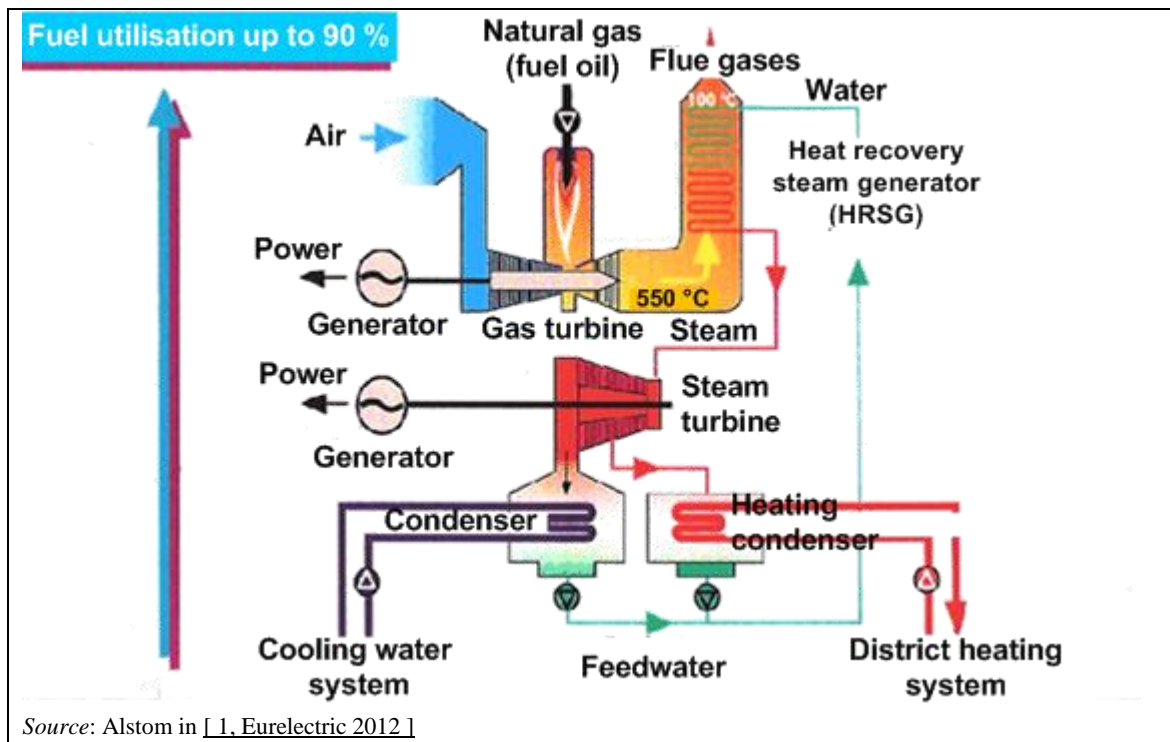

Figure 2.14: Combined cycle power plant cogeneration principle 1+1 system

The application of gas turbines in CHP units is increasing as a means of improving overall efficiency and reducing emissions. As the efficiency of open cycle gas turbines varies from approximately 30 % to 42 %, the efficiency of combined cycles can be up to 61 %, while in a combined heat and power plant fuel utilisation values as high as 90 % can be obtained. It should be emphasised that the efficiency values mentioned apply to new, well-maintained gas turbines at full load and under ISO conditions. At other conditions, the values may be significantly lower.

A gas turbine basically consists of three elements: a compressor, a combustion chamber and an expansion turbine (Figure 2.15). Ambient air is taken in by the compressor through the air intake system, filtered and then compressed to a pressure between 10 and 30 bar in aeroderivative or larger industrial gas turbines. Since a gas turbine uses large amounts of combustion air, the presence of even low concentrations of contaminants in the air can result in a significant fouling of the gas turbine. This could be due to contaminants precipitating on the blades of the compressor, directly affecting the performance of the gas turbine. The combustion air is therefore filtered to prevent this from happening.

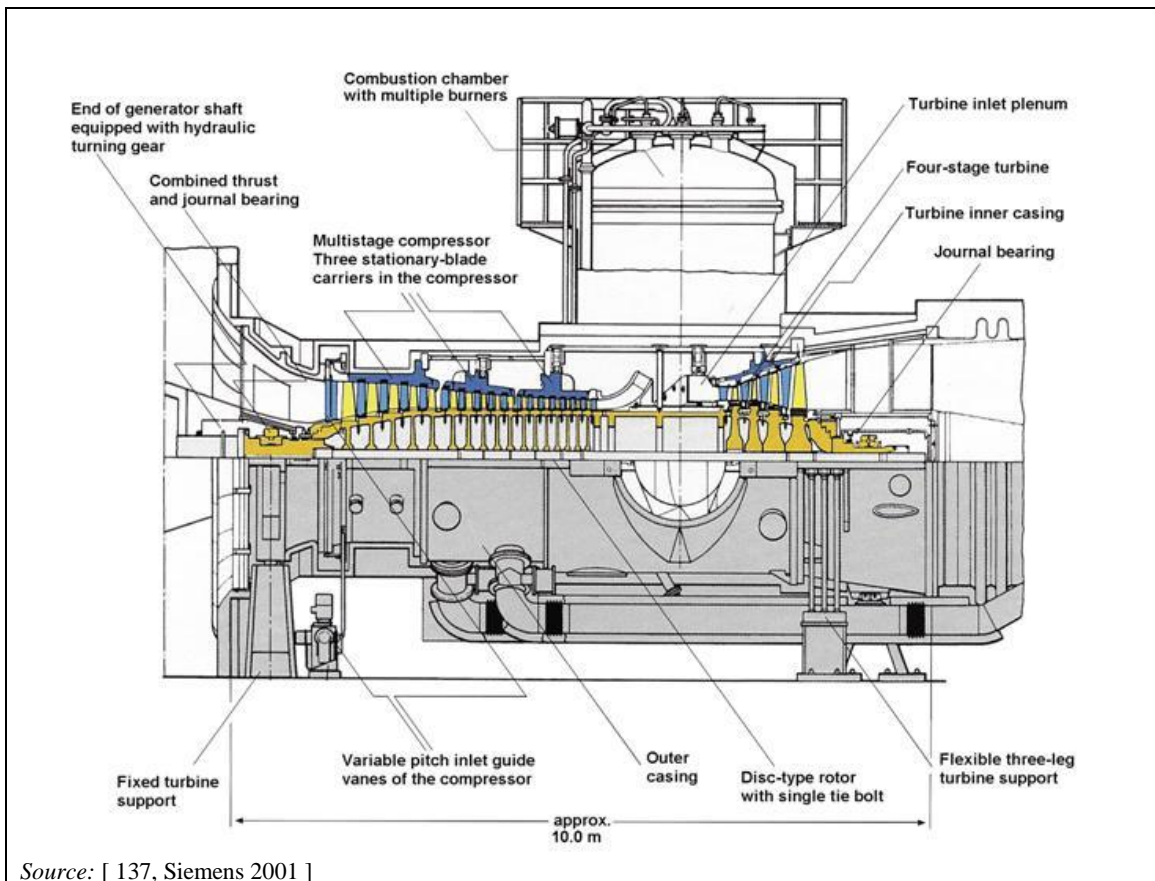

Figure 2.15: Gas turbine (159 MW) with a silo combustion chamber

In the combustion chamber(s), fuel and compressed air are burnt at temperatures of between 1 000 °C and 1 450 °C. After the combustion process, the gas expands through the turbine and generates electric power in the generator, drawing off the power needed to drive the compressors, or the shaft transferring mechanical power in the case of mechanical drive systems.

Gas turbines are designed with one or two shafts. Single-shaft gas turbines are configured with one continuous shaft and, therefore, all stages operate at the same speed. These units are most suited to generator drive applications, where a significant speed variation is not required or is even not wanted. In some cases, a reduction gear is applied between the gas turbine and the generator.

In a multi-shaft gas turbine, the low-pressure part of the turbine (the power turbine) is separated from the high-pressure part, which drives the compressor. The low-pressure turbine is able to operate at a wide range of speeds, which makes it ideally suited to variable speed applications. However, this feature is less important for application in power plants, because the driven equipment (i.e. the generator) is operated at a constant speed during normal operation, related to the grid frequency.

The materials applied in stationary gas turbines can be classified into three main groups: stainless steel (iron-based), nickel-based alloys, and cobalt-based alloys. In general, the materials adopted for compressors are the same as those applied in the high-pressure parts of the steam turbines. Nickel-based materials are usually applied for combustor parts. For gas turbine blades, nickel-based superalloys are applied because of their good mechanical properties at high temperatures.

In order to improve the corrosion and oxidation resistance of superalloys, which is not optimal especially at higher temperatures, coatings are applied on turbine blade materials (necessary as at low temperatures, condensates of moisture and acid solutions are corrosive to the components).

Gas turbines are inherently very noisy, therefore they are built into special noise attenuation enclosures, with silencers integrated into the gas turbine air intake and exhaust gas outlet channels.



Figure 2.16: Recently built gas turbine combined cycle power plant in Belgium

The main requirements of any fuel for use in gas turbines are:

- high calorific value;
- high consistency of heat input to the turbine;
- high cleanliness;
- low corrosiveness, either to accessories or to hot turbine blades;
- low deposition and fouling tendencies, especially on hot turbine blades.

In the open cycle configuration, the combustion gases are released directly into the atmosphere at a temperature of $> 450\text{ }^{\circ}\text{C}$.

2.4 Steam processes

2.4.1 General

Most power plants operate using a steam process that uses the fuel energy to generate steam at a high pressure and temperature, both necessary for high efficiency. The heat transfer from the fuel is used to evaporate the boiler water and to overheat steam. In the steam turbine, the steam is expanded across the pressure drop in the turbine. The pressure drop depends on the cooling medium temperature. The extent of the pressure defines the maximum electrical efficiency. Cooling is necessary to condense the steam. The condensate is then preheated and pumped to the boiler for a new cycle.

2.4.1.1 Typical elements of a steam cycle

The process of generating electricity from steam comprises four parts: a heating subsystem (fuel to produce the steam), a steam subsystem (boiler and steam delivery system), a steam turbine (Figure 2.17), and a condenser (for condensation of the used steam).

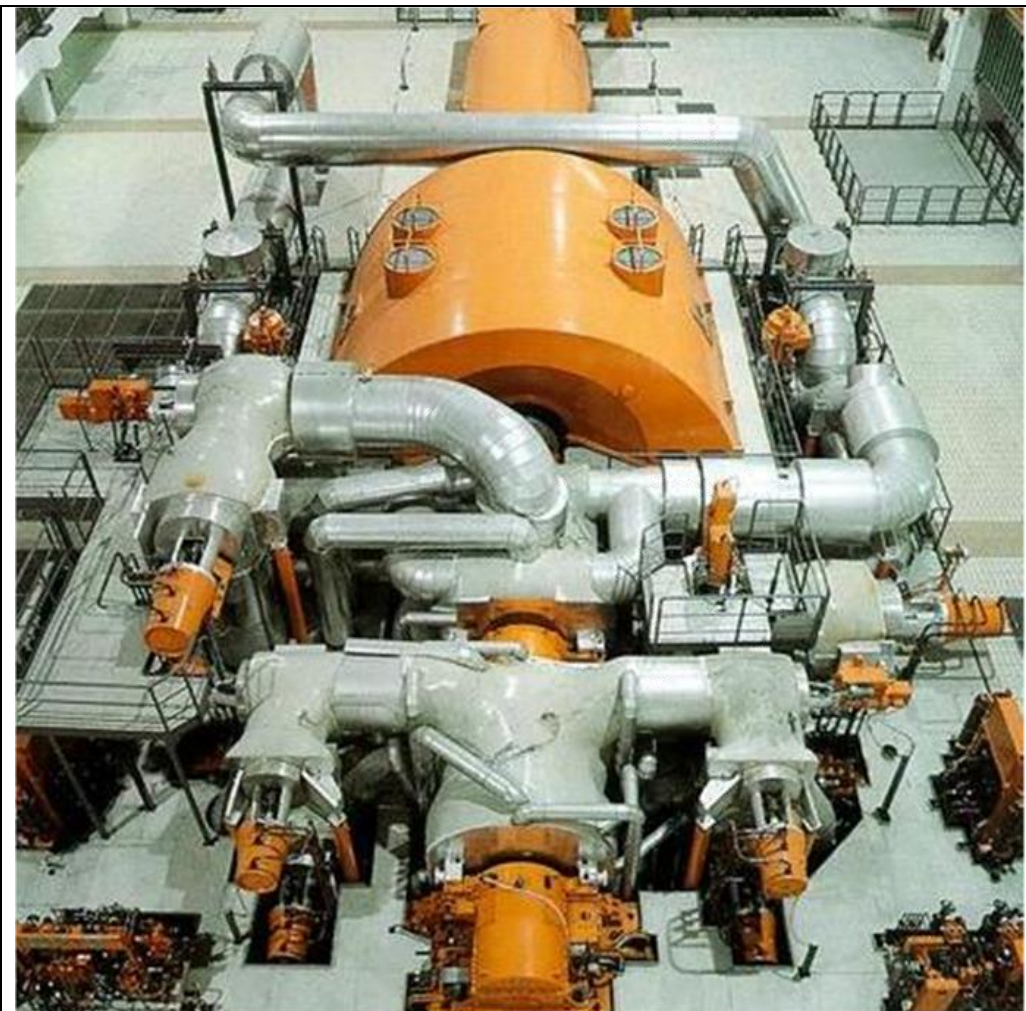

Source: [138, NWS 2001]

Figure 2.17: Steam turbine of a coal-fired power plant

Heat for the system is usually provided by the combustion of coal, natural gas, biomass or oil. The fuel is conveyed into the boiler's furnace. The boilers generate steam in the pressurised vessel in small boilers or in a water-wall tube system (Figure 2.19) in modern utility and

industrial boilers. Additional elements within or associated with the boiler, such as a superheater, reheater, economiser and air heater, improve the boiler efficiency.

Residues from the combustion process include flue-gases and, when coal, biomass or oil is used as fuel, ash.

High-temperature, high-pressure steam is generated in the boiler and then enters the steam turbine, as shown schematically in Figure 2.18. At the other end of the steam turbine is the condenser, which is kept at a low temperature and pressure. Steam flowing from the high-pressure boiler to the low-pressure condenser drives the turbine blades, which powers the electric generator.

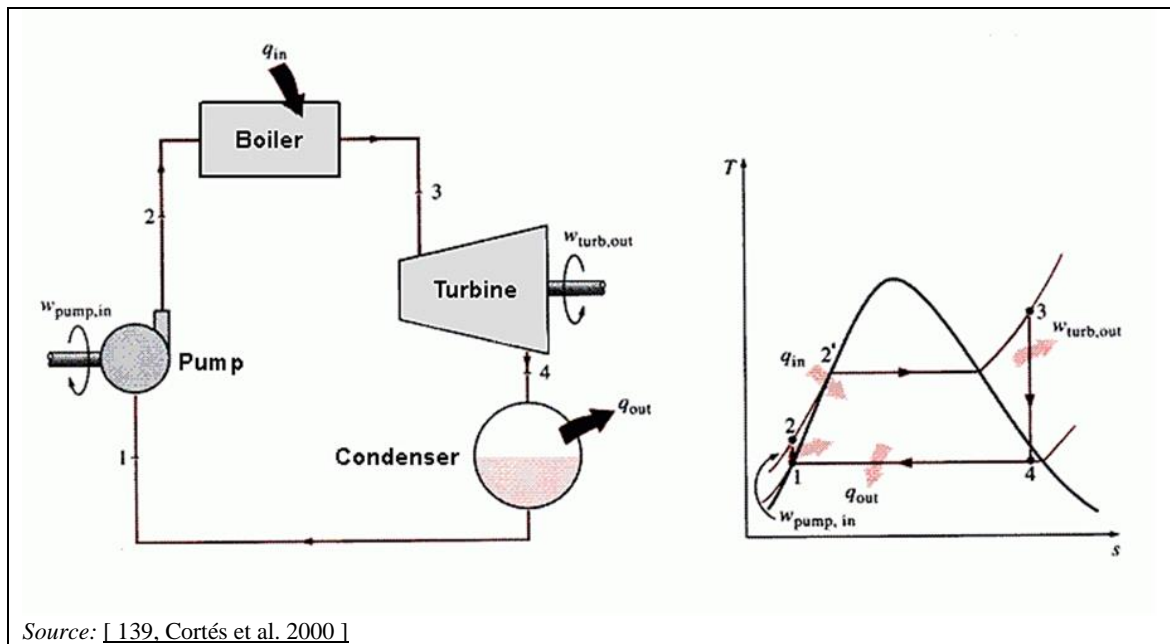

Figure 2.18: Schematic of an ideal combustion Rankine steam cycle

Steam expands as it works, hence the turbine is wider at the end where the steam exits. The theoretical thermal efficiency of the unit depends on the gradient between the high pressure and temperature in the boiler and the low temperature and pressure in the condenser.

Low-pressure steam exiting the turbine enters the condenser shell and is condensed on the condenser tubes. The condenser tubes are maintained at a low temperature by the flow of cooling medium. The condenser is necessary for efficient operation by providing a low-pressure sink for the exhausted steam. As the steam is cooled to condensate, the condensate is transported by the boiler feed-water system back to the boiler, where it is reused. Being a low-volume incompressible liquid, the condensate water can be efficiently pumped back into the high-pressure boiler.

A constant sufficient flow of low-temperature cooling medium in the condenser tubes is required to keep the condenser shell (steam side) at a proper pressure to ensure efficient electricity generation. Through the condensing process, the cooling medium is warmed. If the cooling system is an open or a once-through system, this warm water is released back to the source water body. In a closed system, the warm medium is cooled by recirculation through cooling towers, lakes or ponds, where the heat is released into the air by evaporation and/or sensible heat transfer. If a recirculating cooling system is used, only a small amount of make-up water is required to offset losses by evaporation and the cooling tower blowdown, which must be discharged periodically to control the build-up of solids. Compared to a once-through system, a recirculated system uses about one twentieth of the water. [131, EPA 1997]

2.4.1.1.1 Boiler

In general, three types of boilers are commonly used: natural circulation, forced circulation, and once-through boilers.

Figure 2.19 indicates the major differences between the natural circulation concept and the once-through boiler concept.

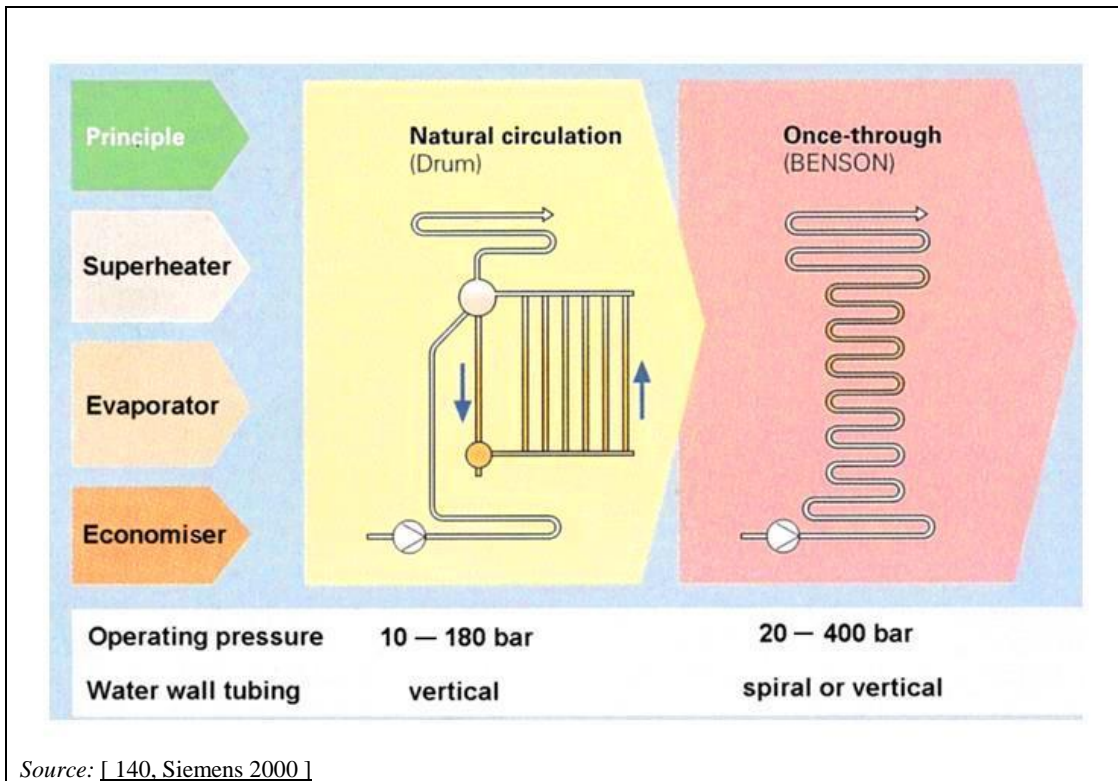

Figure 2.19: The natural circulation and once-through boiler concepts

In natural circulation boilers, the density difference between the water/steam mixture at the outlet (top) and the steam/water at the inlet (bottom) is used to generate a natural circulation. In forced circulation boilers, additionally to the density difference, circulation is supported by circulating pumps. In once-through boilers, the water flow is determined by the feed pump, and the water is evaporated during one single passage. The advantages of the once-through boiler are:

- steam generation is possible at any pressure;
- highest achievable efficiency is possible with supercritical steam parameters;
- high plant efficiency, even with part loads;
- short start-up times;
- sliding-pressure operation with high load transients;
- suitable for all fuels available on the world market.

Boiler components

The boiler or steam generator is a combination of the following components:

- **Economiser:** The feed water is heated in the economiser to a temperature 10 °C below the saturation point. The economiser is the first heat exchanger of the boiler collecting heat from the lower temperature flue-gas at the exit of the boiler.
- **Evaporator:** In the combustion chamber, the energy of the fuel is released and transferred across the boiler and heat-exchanger walls to the water/steam circuit. The heated water is then evaporated in the boiler evaporator to at least saturated steam for subcritical pressure water/steam conditions, or to superheated steam for supercritical conditions. Usually the evaporator tubes constitute the combustion chamber walls and are aligned in a vertical or a spiral arrangement. Modern plants work with supercritical water/steam pressure, i.e. a pressure above the critical point in the water-steam diagram. At supercritical pressure, the conversion occurs without a phase transition, so the evaporation energy is zero and only a peak in heat capacity represents the change in the continuous fluid.
- **Superheater:** The superheater uses the highest temperature flue-gas area of the boiler to produce superheated steam. Usually the superheater stage consists of several heat exchangers with an injection in between. This injection controls the live steam temperature. Live steam temperatures are in the range of 540–570 °C for supercritical units and in the range of about 600 °C for ultra-supercritical units. Superheated steam has a temperature significantly above the pressure-dependent condensation temperature. Such temperatures are necessary to facilitate the high pressure drop in the steam turbine and thus avoid condensation during the expansion of steam in the high-pressure steam turbine. Part of this expanded steam is bled off and used to transfer heat to the feed water.
- **Reheater:** The bulk of the steam is reheated by the flue-gas in the reheater systems to extract further work and to achieve a higher efficiency in the subsequent medium-pressure steam turbine. The hot reheat steam temperature is controlled, e.g. by means of water injection or burner tilt. Reheating is typically used at large power plants. Very large units can also have another superheating stage to further enhance power output.

2.4.1.1.2 Steam turbine

In the steam turbine, the thermal energy of the steam is converted to mechanical work (i.e. turbine shaft rotation). This occurs between the steam inlet point and the condenser, with the steam expansion being used as the driving force. The steam expansion is coupled with a pressure drop and with an adiabatic decrease of the steam temperature. During this adiabatic steam expansion, the temperature of the steam decreases in association with a pressure drop from about 180–300 bar to 0.03 bar for modern LCPs. For larger plants, due to the large difference in pressure, steam expansion is normally effected in three stages: high-pressure (HP), intermediate-pressure (IP) and low-pressure (LP) stages of steam turbines. In most cases, these steps allow the steam to be reheated in reheaters before re-entering the next lowest pressure steps in the steam turbine. For smaller plants, two stages are applied (IP and LP).

2.4.1.1.3 Condenser

Finally, in the condenser located downstream of the low-pressure section of the turbine, steam is condensed back to water (condensate). After expansion in the steam turbine, some condensation and kinetic energy remains in the steam and is not transferable to mechanical energy. Efficient condensation systems allow a reduction in the pressure of the steam turbine to well below atmospheric pressure (vacuum of down to 0.03 bar, depending on the cooling medium temperature and the cooling water mass flow), which is desirable to extract the maximum amount of mechanical energy. This maximises the extraction of mechanical energy from the expansion of steam in the turbine. At CHP plants the condenser can be cooled with district

heating water. With this application the condensing pressure is higher but the steam condensing heat can be utilised for the heating of buildings or industrial processes.

2.4.1.1.4 Cooling system

Cooling techniques are applied to remove the condensation energy from the steam, i.e. the thermodynamically unusable energy of the process. For some detailed information on cooling techniques, refer to the ICS BREF.

The effect of choice of cooling technology on overall plant efficiency is of importance at combustion plants. This leads to the following ordering of cooling system technologies: once-through cooling, natural draught tower-cooled recirculating systems, mechanical draught tower-cooled recirculating systems (including hybrid systems) and dry cooling systems, e.g. air-cooled condensers. Where sufficient volumes of water are available, wet cooling systems result in the highest plant efficiency and electrical output under nearly all conditions. In this case, the environmental impacts of water discharged to the receiving water body have to be considered. Recirculating tower-cooled systems offer slightly lower thermal efficiencies than those achievable with once-through cooling but may be used at locations where water availability is limited or the impact of entrainment and impingement and thermal discharges needs to be reduced. Dry cooling technologies are limited to developments at locations with very restricted water resources or with particular environmental concerns related to water use.

2.4.2 Vacuum condensing power plant

So-called condensing power plants use ambient cooling sources to condense the steam at the lowest available temperature and under vacuum conditions.

Low-temperature cooling water from the sea, a river or lake enables the highest efficiency, followed by warm, summertime temperature water from the same sources. Cooling using an intermediate cooling cycle or cooling towers is generally the least effective technique, due to the higher temperatures of the cooling medium. A temperature gradient between the steam and the cooling medium, and the environment is always needed. As electrical efficiency varies with the ambient temperature, reference data are calculated for standard ISO conditions.

2.4.3 Combined cycle

The idea of combined cycles has grown out of the need to improve the simple Joule cycle efficiency by utilising the waste heat in the turbine/engine exhaust gas. This is a natural solution because the gas turbine/engine is a relatively high-temperature machine and the steam turbine a relatively low-temperature machine.

The flue-gas temperature at a gas turbine outlet for example is about 500 °C or more. This temperature creates the possibility to apply an additional steam cycle process. Such a system combination optimises the gas and steam processes to increase the overall electric or mechanical efficiency.

Combined cycle systems are also used for cogeneration or CHP with additional back-pressure heat recovery of condensation energy. As electrical efficiency varies with the ambient temperature, reference data are calculated for standard ISO conditions. Few combined cycle systems are used in the natural gas transmission system, because their high investment is only reasonable if the use of compressors is high on a yearly basis (e.g. > 6 000 h/yr). In general, the economic feasibility of combined cycle systems depends on the number of annual operating hours. [6, Marcogaz 2012].

Figure 2.20 shows a gas turbine combined-cycle power plant built in Finland.

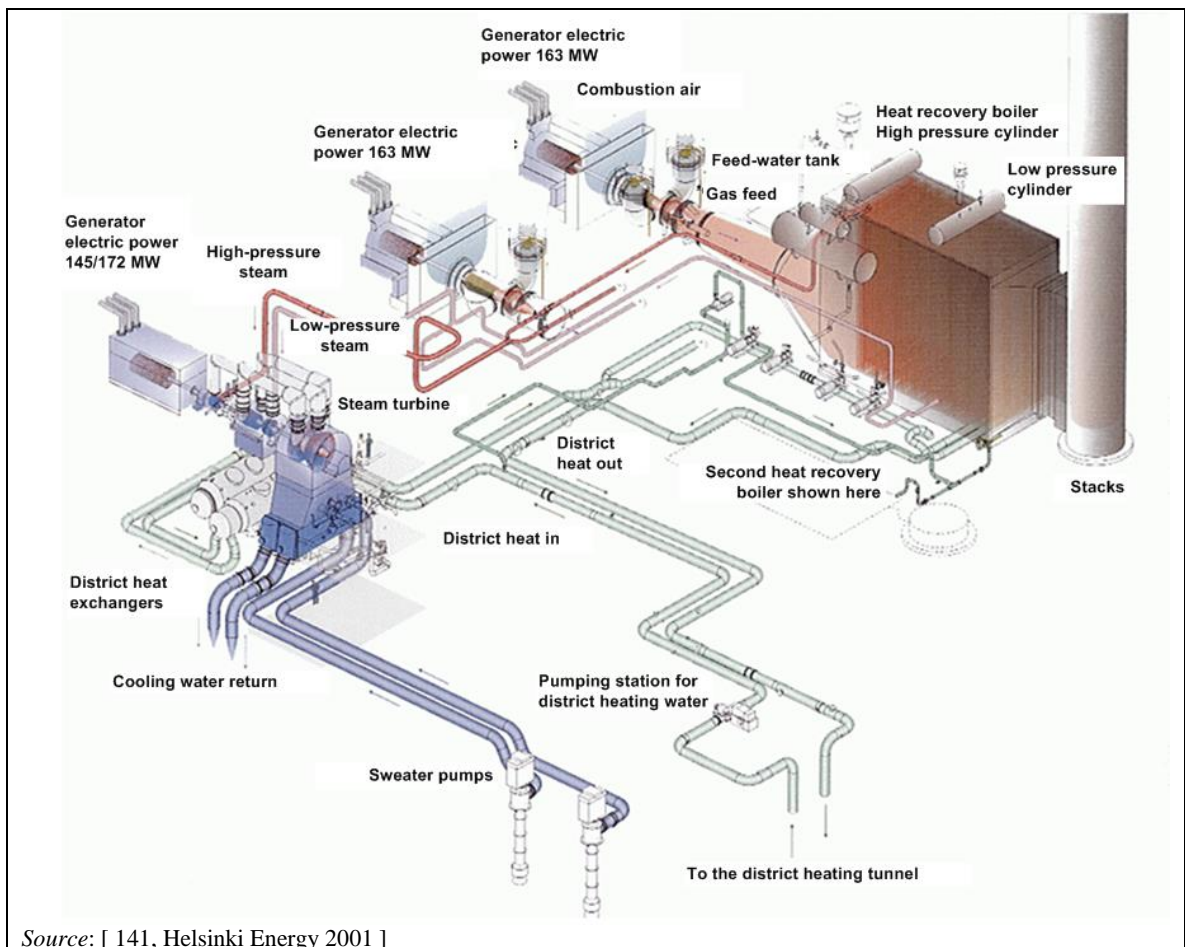

Figure 2.20: Gas turbine combined-cycle power plant

2.4.4 Supplementary firing of combined-cycle gas turbines

Combined cycle gas turbines operate at maximum electrical efficiency at full load. The heat recovery steam generator (HRSG) can be designed with supplementary firing of fuel after the gas turbine in order to increase the quantity or temperature of the steam generated (see diagram in Figure 2.21). Without supplementary firing, the efficiency of the combined cycle power plant is higher, but supplementary firing lets the plant respond to fluctuations in the load. For this reason, supplementary firing of a HRSG is often used for small-scale peak load heat operation in industrial and district heating. This application is often used to improve the cost-effectiveness and flexibility of combined cycle power plants, e.g. in seawater desalination plants in the Middle East. In addition, the incremental pollution of NO_x is very low, due to the lower oxygen content of the combusted flue-gas. The use of a premix burner ensures this low level of emissions. [1, Eurelectric 2012].

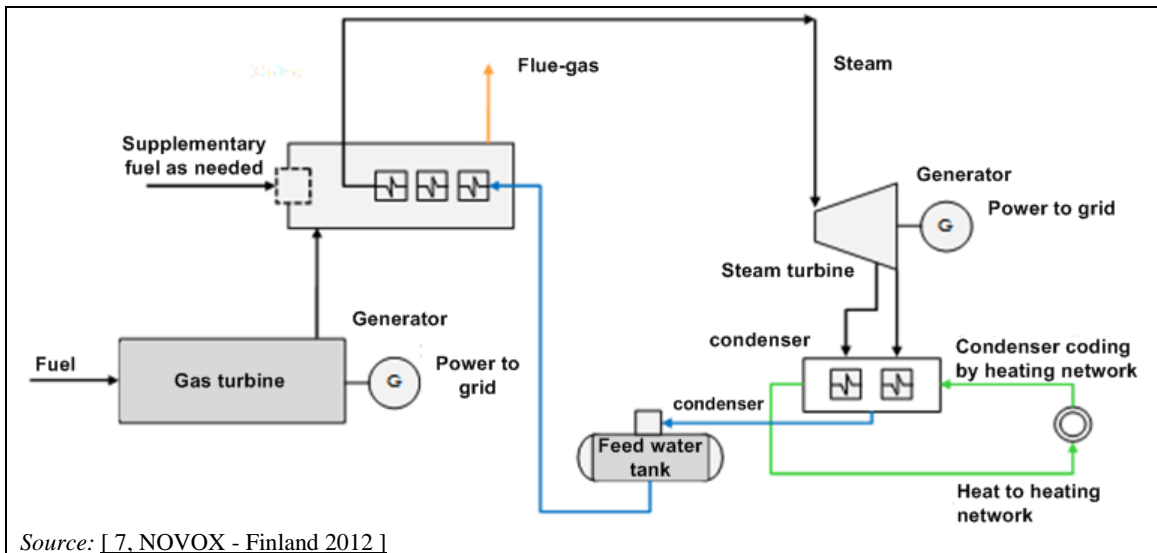

Figure 2.21: CHP based on combined cycle where the steam turbine condenser cooling for the steam cycle is provided by a district heating network

2.4.5 Repowering of existing power plants

Repowering existing coal-/oil-/gas-fired power plants operating a steam process with an additional gas turbine is considered nowadays due to the lower CO₂ emissions of such plants when running on gas. The additional advantages of such an arrangement are the small area necessary for a gas turbine/engine, the high flexibility of such systems, and the fact that the main equipment and components, as well as auxiliary equipment and infrastructure, already exist.

The first applications were the so-called Kombianlagen (combi-plants), where the exhaust gas of the gas turbine was utilised in the steam generator as combustion air with gas or coal as fuel for the steam boiler. Coupling of the existing system with coal for the steam boiler and gas for the gas turbine ensures the flexibility of the gas turbine.

Another repowering option is to use the expanded exhaust gases of a gas turbine or stationary engine to preheat the feed water of another thermal power plant. The economic advantage of such an arrangement is dependent on the relative prices of the primary (e.g. coal) and secondary (usually gas) fuels used in this process.

Repowering can improve the efficiency of an existing plant by up to 5 percentage points (e.g. from 40 % to 45 %)

2.5 Cogeneration or combined heat and power (CHP)

Cogeneration uses a single process to generate both electricity and usable heat. Cogeneration or 'the combined generation of heat and power' (CHP) is a proven technology, and is mainly applied to industrial plants, district heating systems and smaller local consumers.

Only 40–60 % of the fuel energy (measured as the fuel lower heating value, LHV) can be converted into electric power at electricity-only power plants. The rest is lost as low temperature waste heat into the air or water or both. Because a lot of heat is also needed by the end users in space heating and in many industrial processes, the question arises as to how this rejected heat of condensing power plants can be made useful. The thermodynamic answer to this is quite simple: raise the temperature of the rejected heat to the useful level required, e.g. to 70–120 °C for space (district) heating and 120–200 °C for industrial processes. However, this may happen at the cost of power generation.

Cogeneration is a means of improving the energy efficiency by influencing the energy supply system structure. In every case, cogeneration can save fuel compared to the separate generation of heat and power. If the local heat load is big enough, and the cogeneration plant consequently big enough, cogeneration can also save money. Cogeneration may not be feasible if there is insufficient demand for residual heat or steam.

Steam turbines driven by combustion plants have been used for industrial cogeneration systems for many years. High-pressure steam generated in a conventional boiler is expanded within a turbine to produce mechanical energy, which can then be used to drive an electric generator. The power generated depends on how far the steam pressure can be reduced through the turbine, whilst still meeting the site's heat energy needs.

For cost-effective heat generation, higher temperatures are necessary compared to the temperature of a vacuum condensing power plant. One possibility is the extraction of steam for heating use. This steam is lost for electricity production in the low-pressure steam turbine. The other possibility for combined heat and power is to use the district heating network for turbine condenser cooling. Condensation then takes place at about 100 °C to 130 °C and at above ambient pressure. In any case, heat extraction from an optimised water steam circuit reduces electrical efficiency. But as the amount of recovered heat increases, the lost electricity is compensated as usable heat. The typical factor between heat produced and the lost power varies between 4 and 7 depending on the temperature of the recovered heat. With lower extraction temperatures, this factor increases. However, technical and health criteria limit the lowest temperature for district heating systems. Fuel utilisation rates are between 75 % and 99 % in cases where production of electricity and production of heat are combined.

The industrial application of heat can range between high temperatures and low temperatures above ambient temperature. The source of the heat and the heat transfer media (steam, water or other heat transfer fluids) are selected according to the required temperature. In this case, the industrial heat loss can be recovered by a heat recovery steam generator and can be used to generate steam for a lower quality heat supply. The heat consumption is usually more constant in the case of industrial applications than in the case of district heating, which depends on the outdoor temperature. In the latter case, CHP plants are not dimensioned for peak consumption. An example from the Helsinki region is in Figure 2.22, where, in the coldest periods, peak load heating plants are run for a fraction of the time that baseload CHP plants are operated.

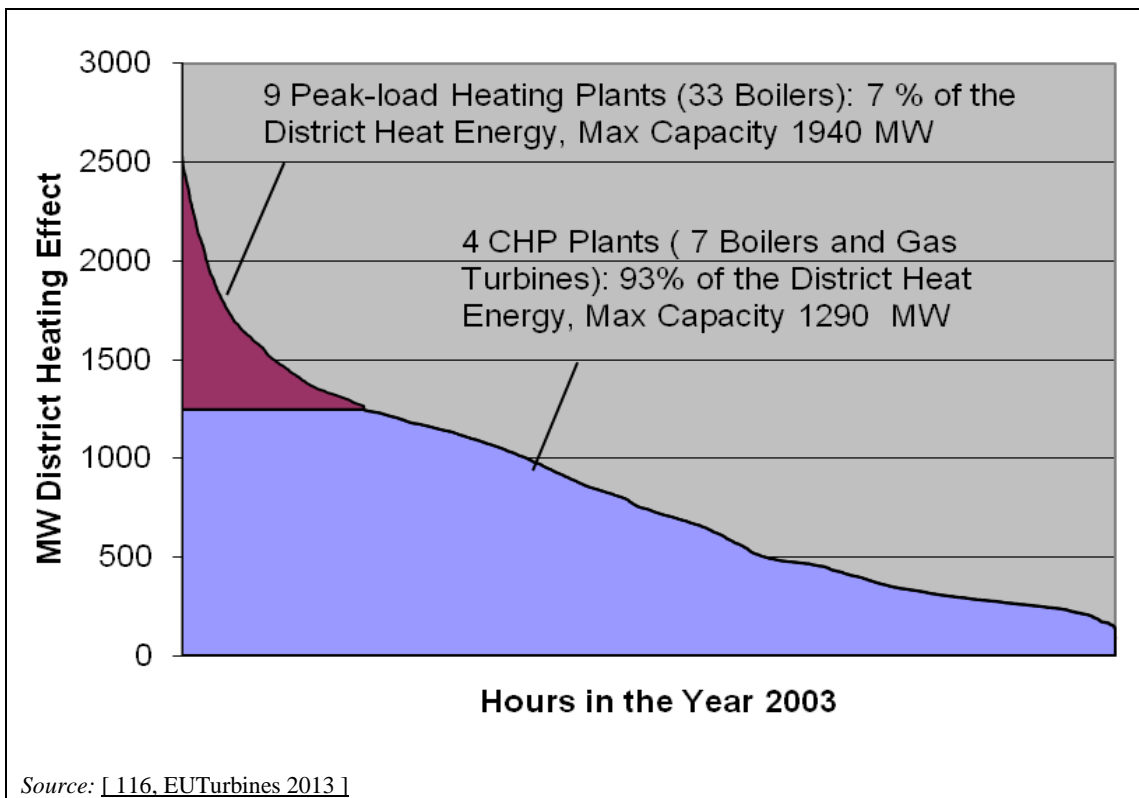

Figure 2.22: Duration curve of the district heating operation in the Helsinki region in 2003

Waste gas heat from steam processes or ‘waste’ condensation heat from a back-pressure steam turbine can be recovered for low-temperature applications. The same conditions as given for district heat applications apply for such utilisation of condensation heat. In general, industrial applications are not limited to winter periods with higher demands for district heating, thus, industrial applications tend to be more cost-efficient.

If no use for the heat supply is available for cogeneration with the gas turbine outlet heat, then recovery for electricity generation with a vacuum condensing power plant may still be possible. In this case, fuel energy utilisation is limited, similar to direct electricity generation with a heat recovery steam generator (HRSG). For this production of electricity, no additional fuel is necessary. With supplementary firing, the production of electricity can be increased. When additional fuel is used to increase the steam production, energy efficiency may decrease as a consequence.

Further details about energy efficiency are given in Section 2.7.

Further information on cogeneration is given in Sections 3.1.1.1 and 3.2.3.2.

Table 2.1 provides information on gross heat and electricity generation from CHP plants and plants generating only heat or electricity in the EU-28 (2013).

Table 2.1: Heat and electricity generated by CHP plants in European countries in 2013

	Gross electricity generation using combustible fuel in 2013 (tonnes of oil equivalent)		Gross heat production using combustible fuel in 2013 (tonnes of oil equivalent)	
	CHP plants	Plants generating only electricity	CHP plants	Plants generating only heat
	39 843.3	82 085.5	35 467.4	13 340.6
Belgium	736.7	1 548.1	686.3	8.1
Bulgaria	423	1 452.7	1 056.7	142.8
Czech Republic	1 175.2	2 485.1	2 036.7	469
Denmark	1 816.5	4.6	1 924.1	737.7
Germany	6 908.2	25 684.9	8 252.9	3227
Estonia	101.9	984.4	251.4	260.9
Ireland	0	1 599.2	0	0
Greece	781.6	2 752	41.5	0
Spain	0	6 985.4	0	0
France	678.8	2 548.3	1 258.6	1 145.6
Croatia	169.3	215	217.8	62.6
Italy	6 585.6	8 643.3	3 079.5	74.1
Cyprus	1	339	1	0
Latvia	251	0.6	417.7	153.8
Lithuania	208.4	0	447.2	342
Luxembourg	111.2	8.2	56.7	4.9
Hungary	376.3	772.5	526.9	551.3
Malta	0	190.5	0	0
Netherlands	2 493.4	3 511.6	2 131.7	133.7
Austria	483.1	486.8	969.7	838.8
Poland	12 608.9	No data	4 273.8	2 500.4
Portugal	16.5	1 301.6	0.8	0
Romania	879.4	935.1	1 581.9	247.3
Slovenia	418.7	46.8	170.5	51.4
Slovakia	430	39.3	563.7	262.4
Finland	1 374.5	756.5	2 784.7	1131
Sweden	813.8	2.4	2 735.3	995.7
United Kingdom	0	18 791.4	0	0
Norway	32.1	9.1	227.6	226.3
Montenegro	0	123.9	0	0
Former Yugoslav Republic of Macedonia	31.1	355.7	21.4	28.4
Albania	0	0	0	0
Serbia	1212.6	1 265.7	76.5	488.5
Turkey	339.6	13 402.6	740.6	0

Source: [117, Eurostat 2013]

District heating networks

Combined heat and power production (CHP) plants have a very high level of total fuel utilisation, achieved by integration and connection of a district heating network with power production. In cases where the heat demand is steady, the CHP plant is dimensioned to fulfil the demand of heat, and the power production process is dimensioned to fit into this heat production.

CHP is widely utilised in cold climate regions of the EU. Cold climate means in this context climate with long periods of sub-zero Celsius temperatures and peak low temperatures down to minus 30 °C. In these conditions, the system reliability and security of supply are very important. To achieve the required high level of supply security, the network consists of one or more main CHP plants, and peak and reserve boiler plants. The heat demand typically varies, along with ambient temperature, hot water consumption and wind. In summer there is only a low demand of heat, mainly for hot water production. The heat demand of the network typically starts to increase when the ambient temperature falls below about +15 °C. [7, NOVOX - Finland 2012]

With regard to district heating boilers, which are typically located within or close to populated areas, district heating may be beneficial on the local air quality. A few large and well maintained boilers with flue-gas cleaning and with high stacks can replace a large number of individual heating installations with low stacks and possibly less controlled combustion. As a result, the total emissions can be considerably reduced. The effect of this is that local air quality in the cities, towns and villages heated with district heating boilers may be far better than it would be if individual heating alone was used.

Industrial CHP

The need for steam at industrial plants varies with the production cycles of the plants. The variation is sometimes rapid and unpredictable because of disturbances in the steam consuming processes. This causes variation and rapid changes in the combustion process of the CHP-plant delivering steam to this type of steam client.

Supply of steam to the industrial users is typically secured by reserve boilers connected to the steam network and usually is not participating to electricity production. A reserve boiler is usually gas or fuel oil fired boiler with fast start up during the failure of the main boiler as industrial plants usually should be secured at least for fast heat supply. Typically reserve boilers annual operating hours are very low, only operating during main boiler annual planned shutdown or unexpected disturbance situations. Some systems are equipped also with steam accumulator vessels, to secure the steam pressure and delivery during quick load changes.

The reserve steam supply units connected to industrial steam networks are typically existing boiler plants which are no longer economical to operate continuously. [8, NOVOX - Finland 2012]

Industrial complexes can produce electricity on site when large heat to power ratios exist, i.e. ranging from 1.5 to 3.

Cogeneration using gas turbines

Gas turbines can be used in industrial CHP plants. Obtaining a supply of heat from a CCGT plant is most likely to be achieved by extracting steam from the plant's steam turbine system. For a district heating scheme, this is likely to be low-pressure steam which is passed through an on-site heat exchanger to produce hot water which is then piped off-site. For industrial applications this may be steam at higher pressures which is piped directly to the customer. In practice, however, the waste heat from the plant's condensers is unlikely to be of any use due to the low temperature (around 25 °C) although there are some exceptions, such as use of condenser water at a slightly higher temperature for liquid natural gas re-gasification.

Cogeneration using engines

Stationary engines are well suited and commonly popular for cogeneration i.e. for hot water production, steam generation (sometimes with an additional steam turbine for enhanced electrical efficiency), desalination of seawater, district cooling systems and for heating air. The total fuel efficiency of this kind of installation is very high, up to 90 % in some applications. The heat to power ratios for engine CHP applications are typically from 0.5 to 1.3. [[136](#), [EUROMOT 2001](#)]

A common heat recovery application for CHP plants with engines is to generate low pressure steam for industrial purposes. The pressure range is usually from 3 bar to 16 bar, but higher steam pressure and extended steam production can be achieved with supplementary firing or auxiliary fired boilers. Steam at 8 bar is well suited for desalination and absorption chillers, while certain industrial processes might require higher steam pressures.

The second solution for boosting the steam generating capacity is to equip the HRSG with supplementary firing. For larger spark-ignited gas engines, the oxygen content is typically 11 to 12 vol-% and for a high pressure gas diesel engine, often higher. This oxygen can be used as the main combustion air for supplementary firing. The system also makes it possible to generate high-pressure steam and it has a good thermal efficiency for the additional fuel for the supplementary firing. So far, there are only a few reciprocating engines which exist equipped with supplementary firing, due to the challenges of combining the combustion flame with the pulsing of the engine flue-gas and the relatively low oxygen content of the flue-gas. [[135](#), [Wärtsilä 2000](#)]

An interesting CHP concept is the feed-water preheating, where the waste heat from the engine flue-gas and cooling circuits are used for increasing the efficiency of an existing, e.g. steam boiler plant. The electrical efficiency of a gas engine plant can be raised by equipping the plant with a steam turbine. Steam turbines most used in this application are single stage condensing turbines and the steam pressure typically applied is 12 bar to 20 bar. In this case, the electrical yield from the plant is increased typically by 8–10 percentage points depending on the engine type used and on the condensing cooling temperature.

Cogeneration using coal- and/or lignite-fired plants

Steam turbines driven by fossil-fuel-fired boilers have been used for industrial cogeneration systems for many years. High-pressure steam raised in a conventional coal- or lignite-fired boiler is expanded within a turbine to generate mechanical energy, which can then be used to drive an electric generator. The amount of power generated depends on how much the steam pressure can be reduced though the turbine whilst still being able to meet the site heat energy needs. In some cases, the turbine is equipped with a separate or integrated low pressure cylinder, which enables electricity production independent of the heat supply

CHP readiness of combustion plants

Given the advantages of cogeneration in terms of general energy efficiency and overall pollutant emissions, the question of the CHP readiness is raised. In the UK, it is recommended that new built combined-cycle gas turbines (CCGT) are 'CHP-ready' (CHPR) and that the 'CHP-lockout' (where the design of a power plant precludes the later take off of heat) is avoided. The degree to which any new CCGT power plant is CHPR is location-specific, based on the current and potential future heat supply opportunities in that particular area. The same principles of CHPR for new biomass power plants are under assessment.

A CHP plant is ideally built to supply both heat and power right from the start, with a known heat load size and profile used to produce an optimum design. In contrast, a CCGT plant which is CHPR is initially built to supply power only, with varying degrees of uncertainty at the design stage over the type and quantity of future heat it may need to supply, if any.

In general terms, it is likely to be easier to retrofit greater quantities of low pressure steam take-off from a lateral exhaust steam turbine than from an axial exhaust steam turbine. This may

therefore influence the choice of turbine if there is a significant chance of a new CCGT being required to supply CHP in the future. Otherwise, the need to be CHPR is likely to have little influence on the choice of steam turbine, due to the range of other options, such as the use of cold reheat.

Location specific CHP-readiness

When existing old boilers come to the end of their working lives, they may be replaced with CCGT power plants built on the same site, due to the ease of electricity grid connection and access to cooling. Because the locations of these sites tend to be away from population centres, new CCGT power plants are not usually built as CHP plants due, to the absence of heat customers in the immediate vicinity. However, this will not always be the case, and where there is a realistic potential for future CHP opportunities in the vicinity of a CCGT power plant, this is taken into account when considering design options. [9, UK-TWG 2012]

Cheng Cycle

The Cheng Cycle is a CHP technology applied to existing or new gas turbines, linked with a steam cycle applied at the gas turbine but not with a combined cycle system. Heat is recovered from the flue-gas through a heat recovery steam generator (boiler) (HRSG), allowing the generation of steam or water for industrial purposes or district heating. But instead of associating a steam turbine to the HRSG to produce electricity out of the remaining heat/steam, the Cheng Cycle redirects the steam to the gas turbine to produce additional electricity and, at the same time, to reduce NO_x emissions.

Applying such a technique to a simple gas turbine improves the overall energy efficiency by allowing recovery of the flue-gas heat. It is an option for variable load demands from both clients: steam and electricity users. Around 300 plants with such a system are reported to be in operation worldwide. [4, deBiasi 2013]

2.6 Integrated gasification combined cycle

The 'integrated gasification combined cycle' (IGCC) merges gasification with gas cleaning, synthesis gas conversion, and turbine power technologies to produce clean and affordable energy (see Figure 2.23). This integration of energy conversion processes provides more complete utilisation of energy resources, and offers high efficiencies and ultra-low pollution levels. Furthermore, an IGCC can convert virtually any carbon-based feedstock into products such as electric power, steam, hydrogen, and value added chemicals. Different technical combinations enable industry to use low cost and readily available resources and wastes in highly efficient energy conversion options. These options can be selected to meet any of a whole host of market applications.

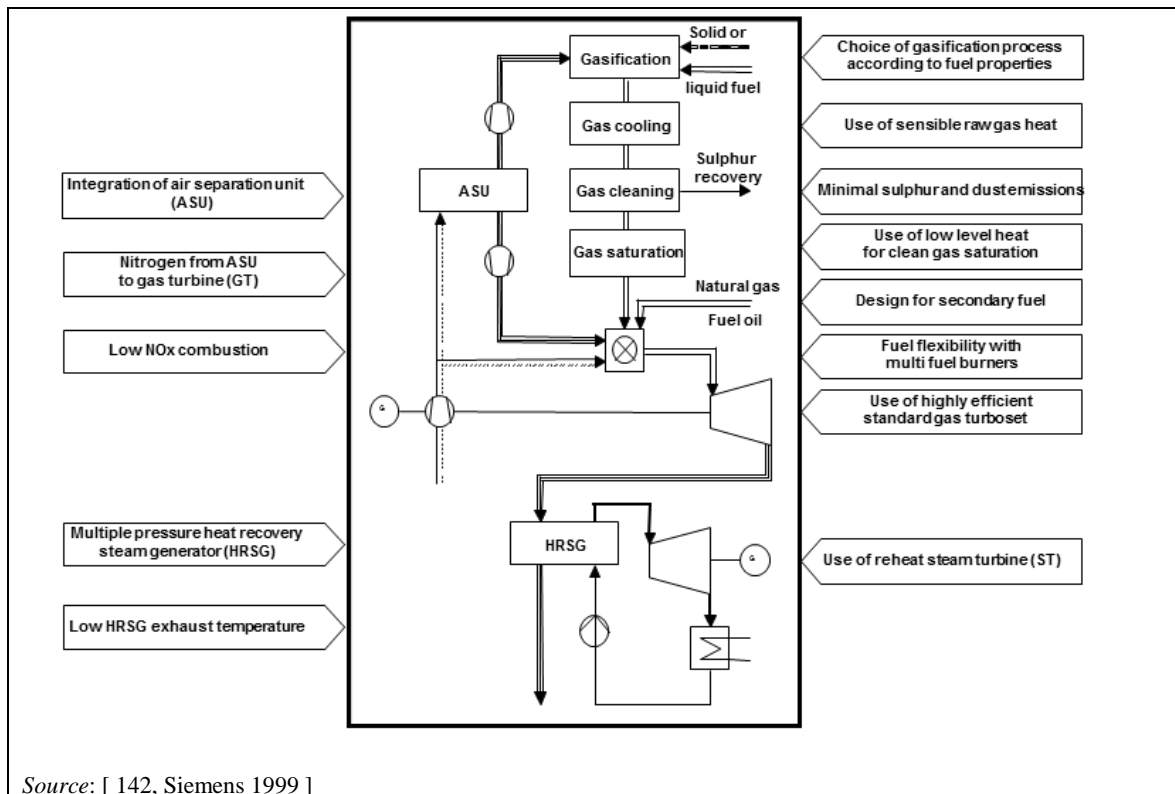

Figure 2.23: Main features of an oxygen-blown IGCC

IGCC is currently applied in a few Italian refineries to convert by-products and residues into valuable hydrogen for the cracking process and CO for generating heat and power (covered under the refinery BREF). Three IGCC plants operated in Spain, the Netherlands and the Czech Republic, convert coke, coal, and biomass into power for the national grid. There are also few other IGCC plants operated worldwide.

2.7 Energy efficiency

The energy efficiency of a power plant is an essential indicator for the assessment of the efficient conversion of fuel energy into electricity, hot water, steam or mechanical energy. Thus, energy efficiency is of particular importance. The energy efficiency level gives information about a low or efficient utilisation of the fuel energy. Assuming the same utilised fuel, it is also an indicator for the specific CO₂ emissions (CO₂/kWh) released during the energy conversion and the amount of fuel used (g fuel/kWh). Using the heat losses from the power process for industrial or district heating purposes increases the energy efficiency in combined heat and power production.

In a survey of countries worldwide, including Australia, China, France, Germany, India, Japan, Nordic countries (Denmark, Finland, Sweden and Norway aggregated), South Korea, the United Kingdom and Ireland (aggregated), and the United States, the weighted average power-generating efficiency for all countries together in 2011 is 35 % for coal, 48 % for natural gas, 40 % for oil-fired power generation and 38 % for fossil fuel power in general [118, Hussy et al. 2014]. According to today's state-of-the-art (year 2011), net efficiencies of about 45 % using ultra-supercritical steam conditions are achieved for coal-fired power plants at an inland site with wet cooling (wet cooling tower operation). When the waste heat is used in CHP applications, the total efficiency can increase up to above 100 % when using a flue-gas condenser. [1, Eurelectric 2012] [5, Eurelectric 2012] [3, LCP TWG 2012].

The energy efficiency depends on several factors, the most important being the following:

- power plant type (steam conditions);
- type of fuel (coal, lignite, gas, oil, biomass, etc.);
- location of the plant site (i.e. northern or southern Europe);
- cooling system (cooling tower, fresh water cooling, air-cooled condenser);
- ageing and fouling;
- capacity;
- operation mode in terms of operated hours over the year;
- heat recovery, e.g. via CHP mode;
- load factor;
- number of start-ups and shutdowns.

[1, Eurelectric 2012]

In the following sections, a detailed differentiation between different energy efficiency definitions is given, as thermal energy flux is often mistaken for electrical energy flux. Furthermore, those influences which have an effect on the electrical efficiency during daily operation are described.

There are different ways of describing the energy efficiency of a combustion plant so it is necessary to say how the efficiency is defined, and under what conditions it is measured. There are also a number of national guidelines, such as VDI 3986, describing acceptance tests and the measurements of certain efficiencies.

The energy efficiencies defined below VDI 3986 are to be understood as efficiencies at a certain electrical output and normal operating mode, as the power station is operated in daily generation mode (e.g. number of mills, number of burners, with or without calorifier). They are calculated from averaged measured values attained from the values recorded over a certain period of time.

2.7.1 Carnot efficiency

The ideal efficiency of a thermal process or ‘Carnot’ efficiency is a measure of the quality of the conversion of heat into work between two temperature levels. The Carnot efficiency can be written as:

$$\eta_c = 1 - T_0/T$$

Here, T_0 is the ambient temperature and T the temperature at which the heat is yielded or taken up, both expressed in kelvin ($T \text{ (K)} = T \text{ (}^\circ\text{C)} + 273.15$).

The Carnot cycle can be used as a comparison cycle since it illustrates the theoretically maximum attainable efficiency of a thermal process. Due to irreversibility in real processes in the form of finite temperature differences in the heat transfer processes and fluid friction losses in the work processes, it is not possible to reach the theoretical Carnot efficiency in a real power plant process (e.g. Rankine cycle). Figure 2.24 compares the ideal (Carnot) efficiency with the efficiencies actually achieved by the combustion (thermal) techniques currently in use.

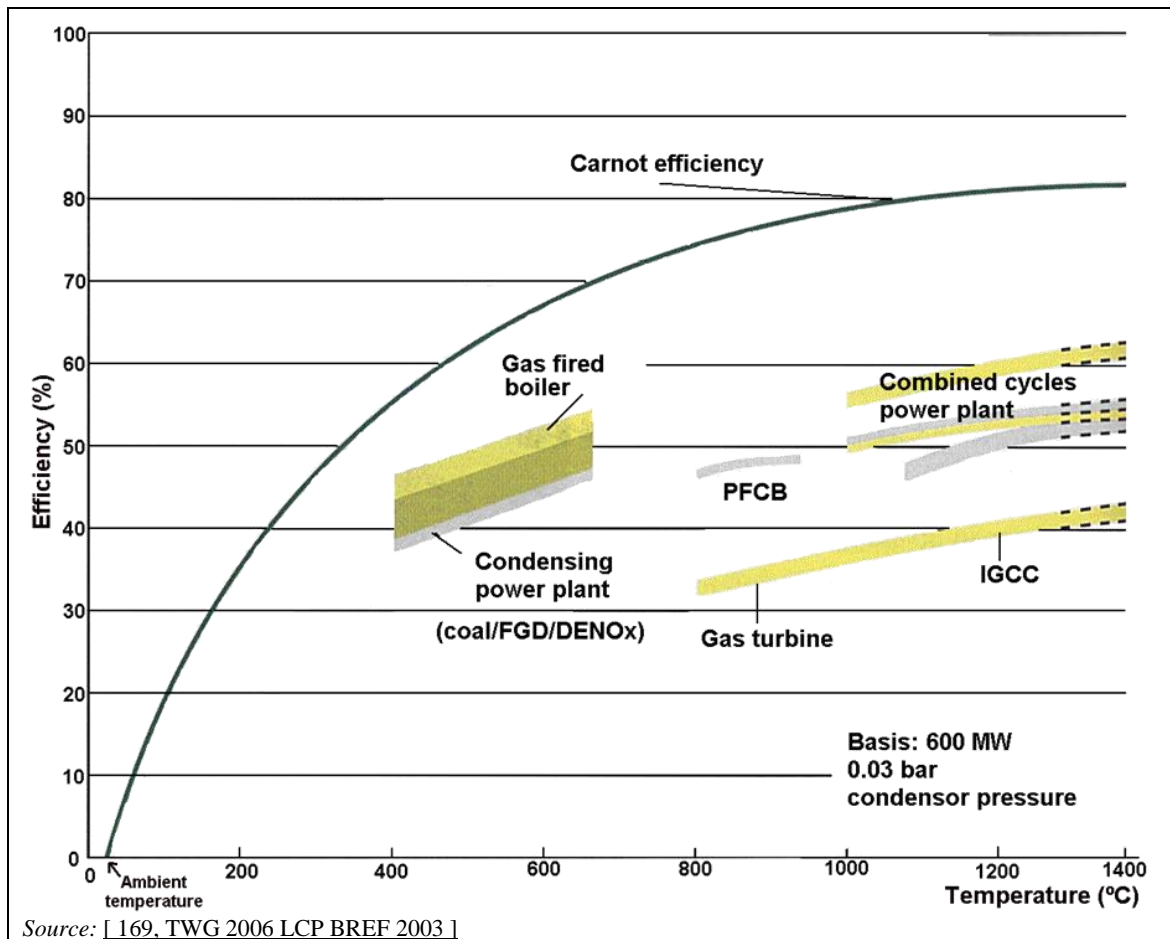

Figure 2.24: Ideal (Carnot) efficiency compared to the efficiencies actually achieved by the thermal energy generation techniques currently in use

2.7.2 Thermal efficiency

The definition of thermal efficiency considers only the actual cycle process used in the combustion plant. The efficiency is then the ratio of the useful mechanical output to the heat flow transferred to the cycle process media (as a rule, air or water).

In this context, the useful mechanical output is the mechanical output from the turbine, when the feed pump is driven by a turbine which is operated with extraction steam from the main turbine. As the condensate pump also contributes to raising the pressure, it is considered to be part of the feed pump, from a thermodynamic point of view. Its mechanical output must therefore be subtracted from the mechanical output of the turbine. The mechanical output of the turbine, in a thermodynamic sense, is in this case the output resulting from the steam mass flow and the enthalpy difference. If the feed pump is driven by an electric motor, then the useful mechanical output is equal to the difference between the mechanical output of the turbine minus the drive outputs of the feed pump plus the condensate pump. This also applies when the feed pump is driven directly by the turbine shaft. The heat flow transferred to the process is that heat flow transferred to the water/steam cycle.

In the case of a combined gas/steam turbine process, the useful mechanical output is the mechanical output of the steam turbine plus the mechanical output of the gas turbine, when the feed pump is driven by a turbine which operates with extracted steam. However, the output of a condensate pump has to be subtracted from this. If the feed pump is driven by an electric motor, then the useful mechanical output is equal to the difference between the mechanical output of the turbine and the drive output of the feed pump plus the condensate pump. The heat flow transferred to the circuit process in a gas/steam turbine process is equal to the heat flow transferred to air in the combustion chamber of the gas turbine, plus the heat flow transferred to the water/steam cycle in the steam generator by combustion. In a pure heat recovery steam generator, the heat flow transferred to the water steam cycle is zero. [147, VDI 1998]

2.7.3 Electrical efficiency

For the definition of electrical efficiency it is important that the system boundaries are defined carefully. A simplified scheme is shown in Figure 2.25. All components within the system boundaries can have an impact on the auxiliary power and therefore an impact to the net values.

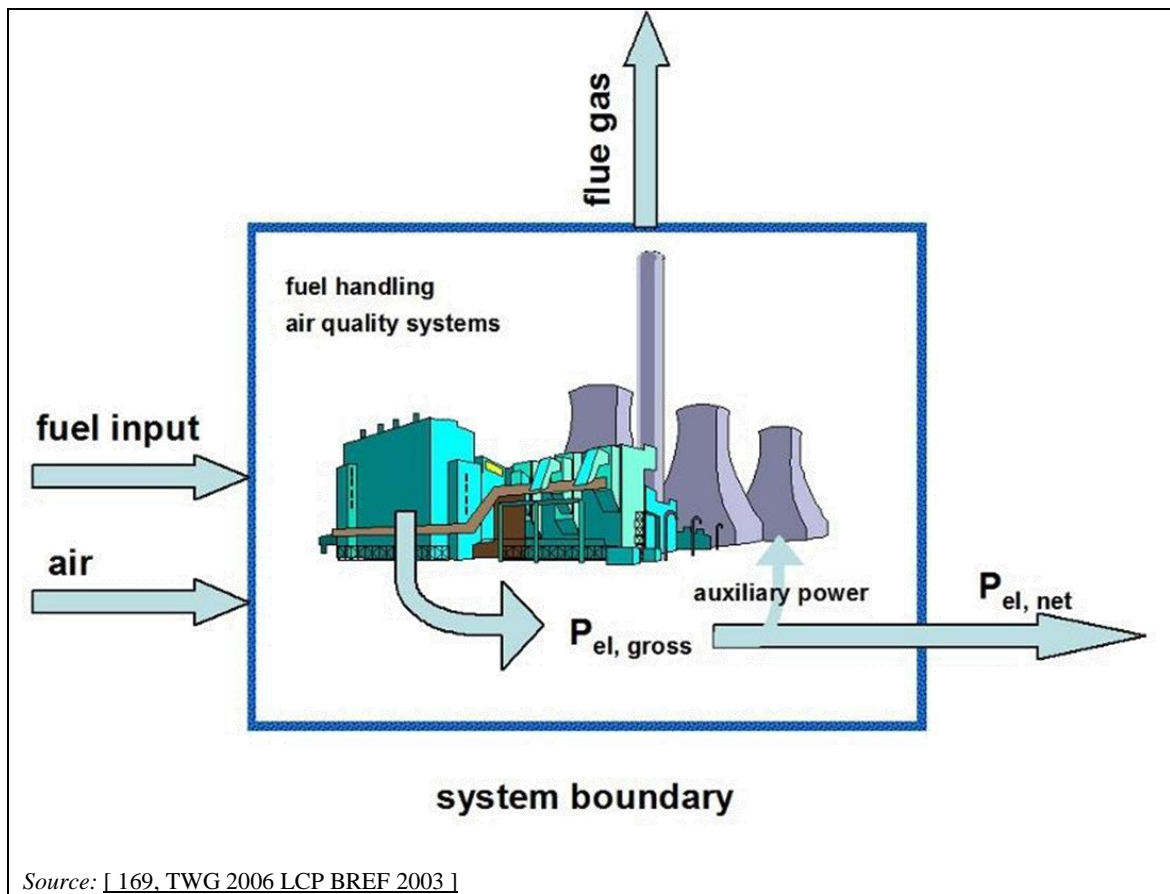

Source: [169, TWG 2006 LCP BREF 2003]

Figure 2.25: System boundaries for efficiency definition

The electrical efficiency is defined as the ratio of delivered or generated effective electrical output of a power plant to the supplied fuel input. In the power plant, the output is delivered in the form of electricity (electricity generation only).

Gross and net power are distinguished depending on the produced effective electrical output of a power plant. The gross power is the electrical power, which is delivered at the generator terminals of the power plant. The net power of a power plant is the power released to the external electrical grid (transmission network). The difference with the gross power output is due to the deductions for the power consumption of all technical facilities, e.g. electrical pumps, coal mills, conveyer belts, air conditioning and ventilation systems, lighting, etc. Therefore, the net power of a power plant is of greater importance than the gross power.

$$\eta_{net} = \frac{P_{el,net}}{\dot{m}_{fuel} H_u} = \frac{P_{el,gross} - P_{aux}}{\dot{m}_{fuel} H_u}$$

In Europe, lower heating value (LHV) is generally used for the determination of efficiency. In other countries, e.g. in the US, the higher heating value (HHV) is predominantly used to determine the efficiency calculation. According to the fuel constituents (water and hydrogen content in the fuel), the ratio between the higher heating value and the lower heating value ranges from 1.03 to 1.11.

The load has a significant influence on the electrical efficiency of a power plant. In part load operation, the electrical efficiency decreases stepwise. The main reason for this is that most of the components in the power plant process do not reach their design conditions, regarding pressure, temperature and mass flow.

In part load operation, the boiler excess air increases due to cooling of the burners that are not in operation. This causes additional losses. The resulting impact on electrical efficiency is illustrated below.

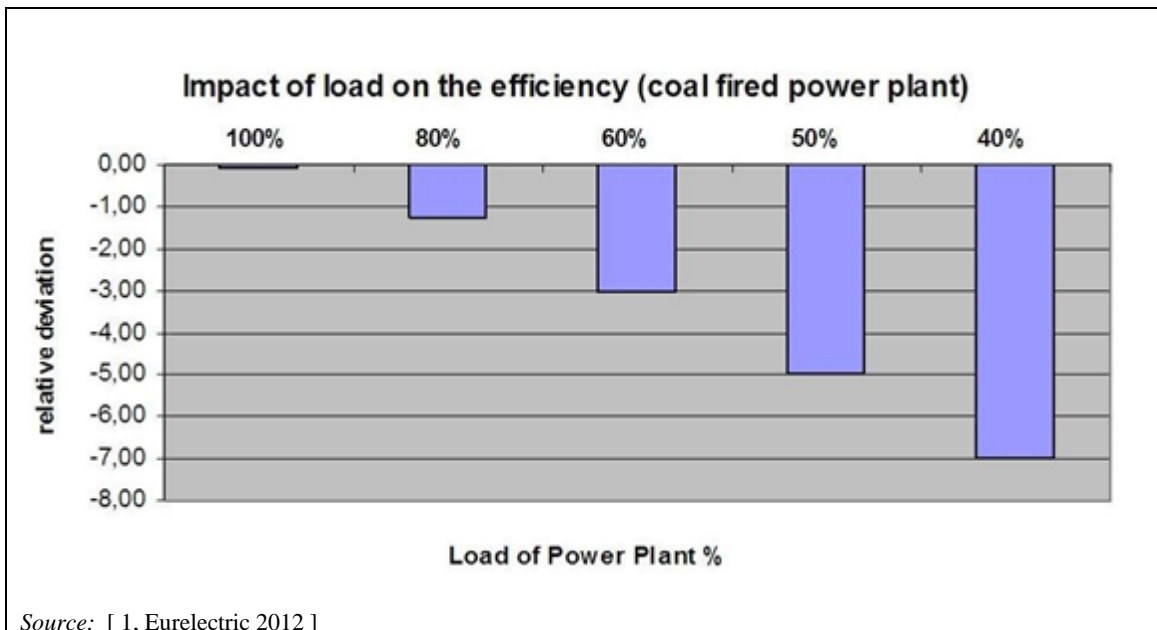

Figure 2.26: Relative deviation of electrical efficiency depending on load for a coal-fired power plant

2.7.4 Mechanical efficiency

For the production of mechanical energy, e.g. to drive natural gas compressors in the gas transmission network, the efficiency is simply equal to the efficiency of the machine itself, as there are no internal uses reducing the product at the shaft of the gas turbine or gas engine. The efficiency of machines for mechanical drive has improved over time, and continues to do so. Older gas turbines have lower efficiencies compared to new ones. The size of the machine is also relevant, smaller ones having lower efficiencies than large ones. This effect can be seen in Table 2.2.

Table 2.2: Typical efficiencies at the output shaft of gas turbines in relation to their thermal power

Plant type	Efficiency (%) ISO conditions		Remarks
	New plants	Existing plants	
Gas turbine 15–50 MW	30–35	27–35	For existing plants depending on their age
Gas turbine 50–100 MW	36–40	27–38	For existing plants depending on their age
Gas turbine > 100 MW	36–40	32–38	

Source: [6, Marcogaz 2012]

2.7.5 Operating (annual) energy efficiency

Even today, electricity cannot be stored in large quantities in the electric grid, so operators have to permanently carry out load adaptations. That means that the power plants may run in frequency support load (part-load operation).

Besides the load fluctuations caused by electricity/industrial consumers, load fluctuations are also increased due to the priority grid access for renewable power plants (e.g. wind power plants, photovoltaic plants, etc.), feeding electricity into the grid often intermittently.

The fluctuating feeding of electricity leads thermal power plants to adapt their load operation, i.e. running in less efficient part-load operation when necessary, or even to be put out of operation.

In addition, it has to be taken into account that the net efficiency of a power plant is only reached with so-called 'delivery terms'. The delivery terms correspond to a theoretical ideal value if the external operating conditions of a power plant are optimal. Besides the load fluctuations mentioned above, external conditions, over which the operator has no control, include ambient air temperature and ambient air pressure.

Operating conditions strongly influence the mean efficiency. The measured efficiency of the plant is different from the design efficiency, as real operation rarely complies with ideal conditions (due to fouling, slagging, de-superheating, non-ideal condenser conditions, blowdown, etc.), due to start-ups and shutdowns, and as the characteristics of the fuel used rarely comply exactly with the characteristics of the design fuel (calorific value, water content, ash content, etc.). The ageing of a normally maintained plant (fouling, slagging, erosion, leaks, etc.) also leads to efficiency deteriorating over time. This can be offset by component refurbishments and upgrades, as shown in Table 2.3. [1, Eurelectric 2012]

Table 2.3: Commonly applicable efficiency improvement techniques at combustion plants

Technique	Efficiency improvement
Replace/upgrade burners	Up to 4–5 percentage points
Improved economiser	A 40 °F increase in flue-gas temperature equals a ~1 percentage point efficiency loss
Improved air preheater	A 300 °F decrease in gas temperature represents about 6 percentage points improvement
Combustion optimisation	0.5–3.0 percentage points
Instrumentation and controls	0.5–3.0 percentage points (in addition to optimisation)
Reduce slagging and fouling of heat transfer surfaces	1–3 percentage points
Reduce air leakages	1.5–3.0 percentage points
<i>Source: [1, Eurelectric 2012]</i>	

Annual energy efficiency is also covered in discussions of the net energy efficiencies defined in Sections 2.7.2 and 2.7.3. It is calculated from the quotient of the usable delivered power and heat and the total amount of supplied energy within the same reporting period (with reference to the calendar year of operation).

2.7.6 Total fuel utilisation

The total fuel utilisation or thermal utilisation efficiency (often indicated as fuel efficiency, total efficiency, net total energy efficiency, fuel utilisation factor or energy efficiency) of a power plant takes into consideration the concurrent production of electricity and heat. It is an indicator to help judge the effectiveness of the conversion of a combustible fuel (lignite, coal, biomass, oil, gas) into the combination products heat and electricity.

The total fuel utilisation is calculated as the quotient of the sum of the electrical and thermal net outputs over the supplied fuels.

$$\varepsilon_{net} = \frac{P_{el,net} + \dot{Q}_{net}}{\dot{m}_{fuel} H_u}$$

The generation of heat (process steam or district heating) and electrical energy can increase the thermal utilisation efficiency to about 70–90 % or even more. This is usually the case when there is sufficient district heat demand, like in industrial applications. However, when the heat demand depends on outdoor temperature in municipal heating for example CHP production may not achieve the full heating load.

During the combined production of electricity and heat, approximately 3 to 20 percentage points of primary energy are saved, compared with the separate production of electricity and heat. With careful handling of primary energy sources and given the potential to reduce greenhouse gas emissions, the combined production of electricity and heat is of particular importance.

The annual thermal efficiency of the combined production of electricity and heat depends on the yearly stability of the heat and electricity consumption.

2.7.7 Unit efficiency for steam withdrawal

In a power plant unit, steam extracted for heating or process purposes is no longer available for power generation. In this case, in order to be able to compare the unit efficiency with the efficiency of pure power generation, the electrical output which could be obtained from the extracted heating steam if it were to expand to the condenser pressure has to be added to the electrical output.

For the extraction of heating steam, a correction for the power loss is used as shown in the diagrams presented in VDI 3986. In these diagrams, the power loss characteristic depends on the flow temperature, with the return temperature as an important parameter for single-stage, double-stage and triple-stage heating. The diagrams apply to condenser pressures of 30, 40, 70 and 80 mbar.

In the case of process steam extraction, the condensate can be returned to the circuit. The influence of the returned condensate can be separated from the influence of the extracted steam. The correction for process steam extraction is also shown in the diagrams presented in VDI 3986.

2.7.8 Exergy concept and exergy efficiency

Since electricity can be converted into heat but the reverse process is not completely possible, electricity then has a higher value than heat. As heat contains a greater share of convertible energy at higher temperatures than it does at lower temperatures, the quality of heat at higher temperatures is higher than at lower temperatures. These issues are covered by the concept of exergy, which expresses the convertibility of energy in qualitative terms. This can be achieved by using quality factors (QF), which give the fraction of exergy in a total quantity of energy. The quality factor of electricity and mechanical energy is 1 (electricity is pure exergy). The quality factor of heat, however, depends on the temperature at which the heat is available. The expression for converting one unit of heat at temperature T into work has long been known. It is called the 'Carnot factor', and has been discussed in Section 2.7.1. The Carnot factor is, quite simply, the quality factor for heat. This factor is always less than 1, becoming 0 at ambient temperature. [143, Electrabel 1996]

By applying such simple quality factors to the energy input ($E_{\text{energy input}}$) and the useful energy output ($E_{\text{useful energy output}}$) of a process, the exergetic efficiency of a combustion process can be calculated and compared to the fuel efficiency. The exergetic efficiency (η_{ex}) can then be expressed as follows:

$$\eta_{\text{ex}} = \frac{\sum(\text{QF} \cdot E_{\text{useful energy output}})}{\sum(\text{QF} \cdot E_{\text{energy input}})}$$

By using this methodology, a comparison of the energetic and exergetic efficiencies can be made, as shown in Figure 2.27.

T_0 = Ambient temperature in Kelvin (0 °C =273 K) E = Electrical energy output (%)
 T_W = Temperature of the supplied heat (in K) H = Usable heat energy output (%)
 QF = Quality factor (exergy/energy ratio) L = Thermal losses (%)
 η_C = Carnot or quality factor for heat ($=1-T_0/T_W$) I = Fuel energy supplied (= 100 %)

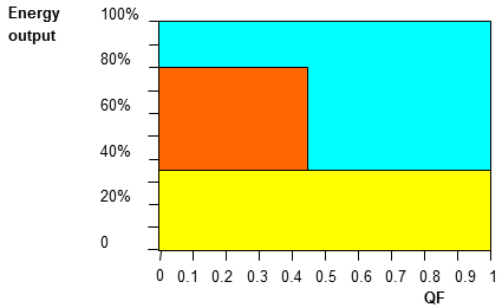

EXAMPLE : Industrial combined heat and power generation.
 Gas turbine (new technology) and recovery steam boiler.

Assumptions: $T_W = 473$ K (200 °C)

$I \rightarrow$
 E = 38% QF(E) = 1
 H = 40% QF(H) = 0.42
 L = 22%

EO = total energy output = E + H
EO = 0.78
 η_{ex} = energy yield = E x QF(E) + H x QF(H)
 $\eta_{ex} = 0.55 (= 0.38 \times 1 + 0.4 \times 0.42)$

Source: [143, Electrabel 1996]

Figure 2.27: Example demonstrating the methodology for calculating the exergetic efficiency

The results from different types of combustion techniques are presented in Table 2.4.

Table 2.4: Examples of energetic and exergetic efficiencies of different types of combustion plants

Combustion technique	Fuel energy supplied (= 100 %)	Electrical energy output (%)	Usable heat energy output (%)	External losses (%)	T_w Temperature of supplied heat (K)	Quality factor of heat (QF = $1 - T_w/T$)	Quality factor of electricity	Total energy output EO (fuel efficiency)	Exergetic efficiency (η_{ex})
Heat generation Type: heating boiler for space heating, where $T_w = 70\text{ °C}$ (343 K)	100	0	90	10	343	0.2	NA	0.90	0.18
Electricity generation Type: combined cycle (recent high-yield combined cycle technology)	100	55	0	45	NA	NA	1	0.55	0.55
Industrial CHP plant Type: steam boiler + back-pressure steam turbine, (where $T_w = 200\text{ °C}$ (473 K) steam for industrial process)	100	20	60	20	473	0.42	1	0.80	0.45
Industrial CHP plant Type: combined cycle with steam tapping, where $T_w = 200\text{ °C}$ (473 K) (steam for industrial process)	100	50	12	38	473	0.42	1	0.62	0.55
Industrial CHP plant Type: gas turbine (new technology) with recovery steam boiler, where $T_w = 200\text{ °C}$ (473 K)	100	38	40	22	473	0.42	1	0.78	0.55
Industrial CHP plant Type: gas turbine with recovery steam boiler, where $T_w = 200\text{ °C}$ (473 K)	100	32	48	20	473	0.42	1	0.80	0.52
Industrial CHP plant Type: gas turbine with recovery steam boiler with back pressure steam turbine where $T_w = 200\text{ °C}$ (473 K)	100	35	45	20	473	0.42	1	0.80	0.54
Small scale CHP plant Type: gas engine with heat exchanger where $T_w = 70\text{ °C}$ (343 K) (for space heating and small-scale industrial applications)	100	35	55	10	343	0.20	1	0.90	0.46
NB: NA: Not available. Source: [143, Electrabel 1996]									

2.7.9 Influence of climate conditions on efficiency

The climate expressed in terms of wet- and dry-bulb temperatures is an extremely important site-specific condition. It influences both the choice of cooling and the possible end temperature of the process. The contradiction of cooling with air and/or water is that when the cooling demand is high it becomes more difficult to achieve the requirements, particularly in areas where high air temperatures and high water temperatures coincide with lower water availability during part of the year. A certain operational flexibility of the cooling system can then be very important and may be achieved by combining water and air cooling. Sometimes, however, a certain loss of efficiency has to be accepted.

To reach the required end temperature, the cooling medium must have a lower temperature than the medium to be cooled, but this depends on the dry- and wet-bulb temperatures. A wet-bulb temperature is always lower than a dry-bulb temperature. The wet-bulb temperature depends on the measured temperature of the atmosphere, the humidity, and the air pressure. For latent (evaporative) heat transfer, wet-bulb temperature is the relevant temperature. It is theoretically the lowest temperature to which water can be cooled by evaporation. For sensible heat transfer, dry-bulb (dry air) temperature is relevant, where air is the coolant.

For the selection of the type and design of the cooling system, the design temperature is important and usually relates to summer levels of the wet-bulb and dry-bulb temperatures. The greater the difference between these temperatures and the higher the dry bulb temperatures, the more difficult it will be to reach low end temperatures with dry air-cooled systems. As mentioned earlier, this can lead to efficiency losses. Measures can be taken to overcome this loss, but they require a certain investment.

As an example, Table 2.5 shows how, for different climate conditions in Europe, the choice of a dry or a wet cooling system can affect process efficiency losses due to the Carnot cycle. In the example, the approach for wet cooling is considered to be 4 K and this has to be added to the wet-bulb temperature to get the minimum end temperature of the coolant. The approach for dry cooling is set at 12 K to be added to the dry-bulb temperature. The larger the difference between the wet and the dry end temperatures, the higher the loss of efficiency (in this example), where losses of 0.35 % per kelvin on average occur. At the same time, for example, with a 5 % efficiency loss, the efficiency of a conventional power plant would be 38.6 % instead of 40 %.

Table 2.5: Examples of effect of climatic conditions in Europe on the loss of efficiency of power plants

Country and station ⁽¹⁾		Parameter						Efficiency loss (⁵) (%)
		Dry-bulb temp. (1 %) ⁽²⁾ (°C)	Wet-bulb temp. (1 %) ⁽²⁾ (°C)	Temperature difference (K)	End temp. dry system ⁽³⁾ (°C)	End temp. wet system ⁽⁴⁾ (°C)	ΔT wet-dry (K)	
Greece	Athens	36	22	14	48	26	22	7.7
Spain	Madrid	34	22	12	46	26	20	7.0
France	Paris	32	21	11	44	25	19	6.7
Italy	Rome	34	23	11	46	27	19	6.7
Austria	Vienna	31	22	9	43	26	17	6.0
Germany	Berlin	29	20	9	41	24	17	6.0
Netherlands	Amsterdam	26	18	8	38	22	16	5.6
France	Nice	31	23	8	43	27	16	5.6
UK	London	28	20	8	40	24	16	5.6
Germany	Hamburg	27	20	7	39	24	15	5.3
Norway	Oslo	26	19	7	38	23	15	5.3
Belgium	Brussels	28	21	7	40	25	15	5.3
Spain	Barcelona	31	24	7	43	28	15	5.3
Finland	Helsinki	25	19	6	37	23	14	4.9
Denmark	Copenhagen	26	20	6	38	24	14	4.9
Portugal	Lisbon	32	27	5	44	31	13	4.6
UK	Glasgow	23	18	5	35	22	13	4.6
Ireland	Dublin	23	18	5	35	22	13	4.6

⁽¹⁾ The given data in the table are illustrative of the variation of the climate in Europe. Other references may provide slightly different data. The exact data of a site can be analysed by a meteorological institute.
⁽²⁾ Statistically only 1 % of the maximum temperatures are above this data.
⁽³⁾ Approach 12 K.
⁽⁴⁾ Approach for wet system: 4K.
⁽⁵⁾ Loss of efficiency 0.35 % per ΔT K on average.
Source: [144, Eurovent 1998]

2.7.10 Relationship between energy efficiency and environmental issues

2.7.10.1 Impact of the abatement techniques on plant energy efficiency

The operation of the abatement techniques installed to prevent or reduce the emission of pollutants usually requires the use of additional electricity and/or heat. This is associated with a number of energy-consuming processes, including the following operations:

- additional flue-gas fans to compensate for pressure drops;
- pumps for the recirculation of liquids and slurries;
- mechanical shaking or pressurised air blowing for filter cake removal;
- high-voltage fields in ESPs;
- flue-gas reheating e.g. in the case of tail-end SCR.

The main techniques used in LCPs for the reduction of channelled emissions to air are described in Section 3.2.2. Table 2.6 provides a summary of the typical values for energy consumption of secondary abatement techniques. Primary techniques, such as the use of fuels with low sulphur contents or of low-NO_x burners, usually have no or minimal direct energy consumption. However, some primary techniques, for instance certain techniques to reduce NO_x emissions, may affect the parameters of the thermodynamic cycle and thus may present some trade-offs with energy efficiency, as also described in Section 1.3.8. The extent to which these effects occur is fuel- and process-specific and is described in the fuel-specific sections where information is available.

Table 2.6: Typical energy consumption of secondary abatement techniques

Main pollutant addressed	Technique	Energy consumption as % of gross electrical output	Reference Section in this BREF
Dust	ESP	0.32 %	3.2.2.1.1
	Bag filters	Up to 0.6 %	3.2.2.1.2
	Wet scrubbers	Up to 3 %	3.2.2.1.4
SO _x	Wet FGD	1–3 %	3.2.2.2.1
	Seawater scrubber	0.8–1.6 %	3.2.2.2.2
	Spray dry absorber/scrubber	0.5–1 %	3.2.2.2.6
	CFB dry scrubber	0.3–1 %	3.2.2.2.7
	DSI	0.2 %	3.2.2.2.8
	In-furnace sorbent injection	0.01–0.2 %	3.2.2.2.9, 3.2.2.2.10
	NO _x	SNCR	0.1–0.3 %
	SCR	NI	3.2.2.3.11
SO _x NO _x	DeSONO _x	2 %	3.2.2.4.3
SO _x NO _x metals	Activated carbon	1.2–3.3 %	3.2.2.4.1
NB: NI: No Specific Information provided CFB: Circulating fluidised bed; DSI: Duct sorbent injection; ESP: Electrostatic precipitator; SCR: Selective catalytic reduction; SNCR: Selective non-catalytic reduction; FGD: Flue-gas desulphurisation.			

2.7.10.2 Effect of increasing the plant energy efficiency on emission levels

According to [145, UBA AT 2000], increases in efficiency have the following effects on fuel consumption, waste heat and emissions.

Savings in fuel	$\Delta e = 1 - \frac{\eta_1}{\eta_2}$
Reductions in waste heat	$\Delta a = \frac{\Delta e}{1 - \eta_1}$
Reductions of CO₂ emissions	$\Delta C = 1 - \frac{\eta_1}{\eta_2}$
Reductions in pollutant gas emissions	$\Delta \varepsilon = \frac{3.6 \cdot V_R \cdot x}{H_u} \cdot \left(\frac{1}{\eta_1} - \frac{1}{\eta_2} \right)$ (mg/kWh)
Variables:	
η_1	efficiency before improvement
η_2	efficiency after improvement
V_R	volume of flue-gas/kg fuel (m ³ /kg)
x	emission concentration (mg/m ³)
H_u	lower calorific value (MJ/kg)

2.7.11 Losses of efficiency in combustion plants

The heat energy resulting from the combustion of fuels is transferred to the working medium (steam). During this process, part of the energy is lost. The operation of the steam generator requires continuous surveillance. The heat losses from the steam generator can be categorised as follows:

- Losses via the flue-gas. These depend on the flue-gas temperature, air mix, fuel composition and the level of fouling of the boiler.
- Losses through unburnt fuel, the chemical energy of which is not converted. Incomplete combustion causes CO and hydrocarbons to occur in the flue-gas.
- Losses through unburnt material in the residues, such as carbon in bottom and fly ash.
- Losses via the bottom and fly ash from a DBB and the slag and fly ash from a WBB.
- Losses through conduction and radiation. These mainly depend on the quality of insulation of the steam generator.

In addition to the heat losses, the energy consumption needed for the **operation of auxiliary machinery** (fuel transport equipment, coal mills, pumps and fans, ash removal systems, cleaning of the heating surfaces, etc.) also has to be taken into consideration.

Poor combustion lowers the economic viability, increases the environmental impacts and is detrimental to the safety of the plant. The following parameters affect the viability of the plant and may, therefore, be monitored to keep the plant's efficiency as high as possible:

- fuel composition;
- fineness of grind;
- flue-gas composition (O₂, CO₂, CO);
- air mix and flue-gas volume flow;
- air leaking into the combustor;

- boiler fouling;
- temperatures of the combustion air and flue-gases;
- temperature behaviour within the heating surfaces;
- reduction of draught;
- flame profile;
- combustible proportion of residue (annealing loss).

The operation mode in terms of operated hours over the year, load factor and number of start-ups and shutdowns may influence the efficiency of the combustion plant.

2.7.12 General technical measures to improve LCP efficiency

Cogeneration (CHP)

The generation of heat (process steam or district heating) and electrical energy increases the fuel efficiency (fuel utilisation) to about 70–90 % or even more. Cogeneration (CHP) is also regulated by other directives (Energy Efficiency Directive, 2012/27/EC, and Cogeneration Directive, 2004/8/EC) and is dependent on local conditions.

Combustion

The fuel is mixed with air and burnt in the boiler. It is not possible to obtain an ideal mix between the fuel and air, and therefore more air than is necessary for stoichiometric combustion is supplied to the boiler. Furthermore, a small percentage of the fuel does not fully combust. The flue-gas temperature must be kept high enough to prevent condensation of acid substances on the heating surfaces.

Unburnt carbon-in-ash

Optimisation of the combustion leads to less unburnt carbon-in-ash. It should be noted that NO_x abatement techniques using combustion modification (primary measures) show a tendency of increased unburnt carbon. Increased unburnt carbon could also worsen and harm the quality of the coal fly ash and make difficult, or even prevent, their utilisation for certain applications, with the risk that they may not comply with the specifications and requirements laid down in relevant national and European standards.

Air excess

The amount of excess air used depends on the type of boiler and on the nature of the fuel. Typically, 12–20 % excess air is used for a pulverised coal-fired boiler with a dry-bottom. For reasons of combustion quality (related to CO and unburnt carbon formation) and for corrosion and safety reasons (e.g. risk of explosion in the boiler, if there is a flameout due to a low excess of air and then reignition where there is sufficient excess air), it is often not possible to reduce the excess air levels further.

Steam

The most important factors in increasing efficiency are the highest possible temperature and pressure of the working medium. In modern plants, the partially expanded steam is reheated by one or more reheating stages.

Flue-gas temperature

The flue-gas temperature leaving the clean boiler (depends on the fuel type) is traditionally between 120 °C and 170 °C, kept high enough to minimise risks of acid corrosion by the condensation of sulphuric acid. However, some designs sometimes incorporate a second stage of air heaters or a flue-gas heat recovery system to lower this temperature below 100 °C, but with special claddings on the air heater and the stack which makes this reduction economically unprofitable.

Vacuum in the condenser

After leaving the low-pressure section of the steam turbine, the steam is condensed in condensers and the heat released into the cooling water. In order to ensure the maximum pressure drop over the steam turbines, it is desirable to reduce the vacuum to a minimum. In general, the vacuum is dictated by the temperature of the cooling water, which is lower with once-through cooling systems than with a cooling tower. The best electrical efficiency is possible by seawater or fresh water cooling and a condenser pressure of approximately 3.0 kPa. Air cooling usually results in significantly lower efficiency.

Variable pressure and fixed pressure operation

In fixed pressure operations, the pressure before the turbines at all load levels is kept more or less constant by changes in the flow cross section at the turbine inlet. In variable pressure operations with the turbine inlet cross section at its maximum, the power output is regulated by changes in the pressure before the turbines.

Generally, the cycle efficiency is higher when the throttle loss of the valve upstream of the turbine is minimised. Boilers with a fixed pressure operation mode experience an efficiency loss particularly in part load.

Condensate and feed-water preheating

The condensate coming out of the condenser and the boiler feed water are heated by steam to just under the saturation temperature of the extracted steam. The thermal energy from the condensing process thus feeds back into the system, reducing the amount of heat otherwise released from the condenser, therefore improving the efficiency.

The optimisation measures taken to improve the efficiency of power plants between 1993 and 2000, which resulted in a CO₂ reduction of 11.0 million tonnes per year, are shown in Figure 2.28.

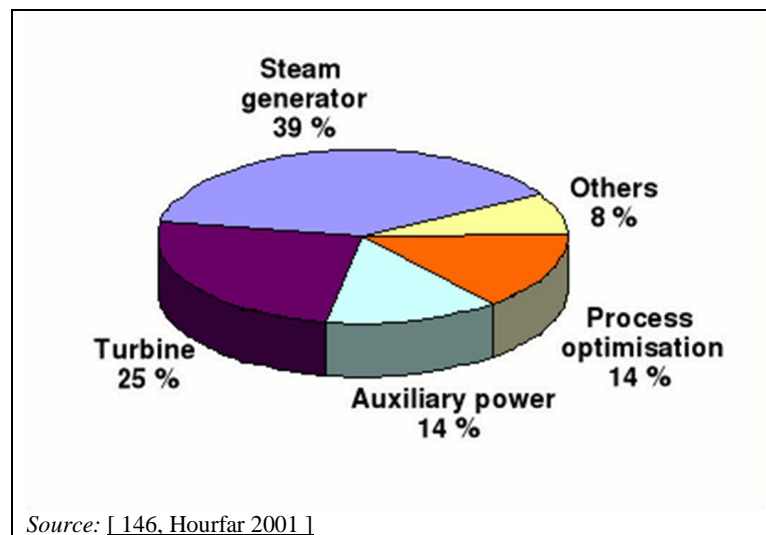

Figure 2.28: Improvements in the efficiency of power plants between 1993 and 2000

2.8 Unloading, storage and handling of fuel and additives

2.8.1.1 Solid fuels and additives

Fuels

Solid fuels such as coal and lignite are supplied by ships, trains and lorries, depending on the transport distance involved and what transport systems are available at mines and LCP sites. Unloading normally takes place with belt conveyors. LCPs near mines or harbours may also be supplied with fuel directly from the mine or harbour by belt conveyors.

Coal and lignite are normally stored in open stockpiles (coal yards) with a storage capacity from a few days up to three month use, and in several cases even enough supply for up to one year of operation. This additional storage capacity helps fuel supply security, as it lessens the dependence on transport logistics. The capacity of the storage facility depends on various parameters, such as, for example, fuel prices and availability, the company's stock policy, security of the supply and on weather conditions. For newbuild plants, layout considerations and availability footprint will also be considerations Fuel is normally transferred from the stockpile to the plant using belt conveyors. A buffer storage (e.g. coal bunkers with a capacity for a few hours operation, usually from 4 to 24 hours) exists within the LCP to cover periods when delivery from the coal yard is not possible.

The storage and transport of fuel can cause dust formation. For this reason, open stockpiles may be sprayed with water to control fine dust particle emissions, unless the fuel's moisture is already high enough that spraying is not necessary. During open loading and unloading of the stockpile, the height of the fuel drop onto the stockpile or between belt conveyors has to be as low as possible to avoid fugitive dust emissions. In urban regions, transport systems are often closed systems and operated with pressures below atmospheric pressure to minimise fugitive emissions. Bag filters are often used to clean the collected air of dispersed fuel particles.

A sealed surface with drainage systems is an option to prevent soil and groundwater contamination from coal storage. It is not however a technique applied within the industry in Europe. Experiments on a plant in Denmark have shown that precipitation on a pile of coal penetrates the stack by 75 cm over a year. Normally the free void in stored coal is approximately 30 %, implying 1 m³ coal can contain 0.3 m³ water. Coal in working storage will therefore be removed and fired before the precipitation has penetrated the stored volume and leached to the subsurface. In long-term storage areas, secondary techniques such as dozing the coal yard in order to compress the coal storage are generally used. This also prevents self-ignition and reduces fugitive dust emissions.

For certain solid fuels, full enclosure during both transport and storage is now being specified. This is, for instance, the case with petroleum coke, where fine dust enriched with higher levels of nickel, vanadium and PAHs can be released by transport and storage unless specific mitigating actions are taken.

The approach to fuel transportation, unloading, storing, and the handling of biomass and peat is different to that of coal. In particular, these fuels are prone to self-heating and ignition. Short storage times are preferred where feasible.

Peat in particular is reactive and can self-heat/self-ignite or decompose slowly if kept in storage for a long time. Typically, only a few days' consumption of peat is actually stored at the power plant site. Peat is usually stored, even for periods of years, in stockpiles in the production area. Likewise, biomass is also prone to smouldering; therefore an effective monitoring system may be put in place to mitigate uncontrollable outbreaks of fire.

To minimise the risk of self-ignition, fuel mixing and downsizing before storage are taken into consideration. [86, Eurelectric 2013].

Peat and/or biomass are transported by articulated lorries, trailers, rail, ships and barges or, for even shorter distances, by tractor-trailers.

Peat has many characteristics that put special demands on the handling and transportation equipment. These include:

- relatively low calorific value because of the rather high moisture content (40–50 wt-%);
- low density;
- tendency to freeze (due to the high moisture content);
- risk of self-heating/self-ignition;
- bridging;
- dust-raising propensity;
- frequent considerable amount of mechanical impurities like wood and stones, or, in wintertime, frozen peat.

The impact of peat transportation depends on the method of transport and the distance. The environmental impact from rail transportation is of minor importance as only some noise will be generated. Road transportation causes noise and results in vehicle emissions. Life cycle analyses carried out, however, show that the emissions from peat production and transportation are of minor importance compared to the emissions from combustion.

In some countries, biomass and peat are usually local fuels and as they are collected near the combustion plant the impact of the transportation is low. In industrial plants, biomass may come as a by-product from the mill.

Choice of fuel-receiving station, storage facilities, transportation to the boiler, etc. depend largely on the type of fuel. Some plants are, due to fuel quality, equipped with screens where large stones and pieces of biomass (i.e. wood) are removed. At some sites the larger pieces of wood are added back to the fuel after they have been crushed. Depending on the fuel and operating conditions, some biomasses are shredded and possibly mixed with other types of fuel. This may be carried out when receiving the fuel or just before transport to the boiler. A typical fuel-handling system (co-combustion of peat, wood, and coal) is presented in Figure 2.29.

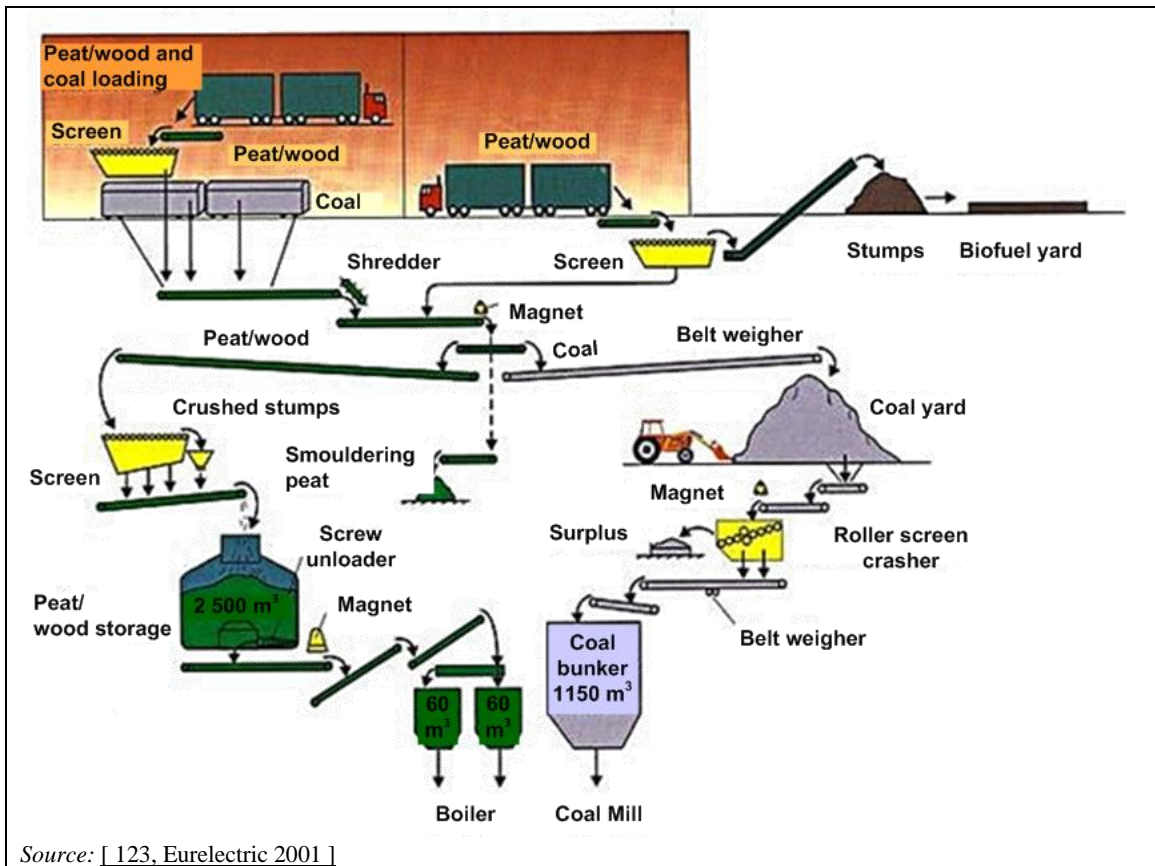

Figure 2.29: Peat, wood and coal handling system

Closed silos and storage areas with dedusting devices are necessary when storing fine dusty biomass. Chips and bark are stored for longer periods in open stockpiles, with covered storage reserved for the screened and crushed fuel that is to be used for daily use.

Fuel is normally transferred from the stockpile/receiving station/silos to the boiler using belt conveyors. Dust generated during peat unloading and handling can cause local harm in the plant area. Closed conveyors can be used to reduce the impact of any dusty material.

A major hazard of peat-fired power plants is the risk of fire and explosion. Dry peat ignites by sparks or hot surfaces like bearings very easily, and also dry, fine dust may explode even before it reaches the boiler; either on the peat conveyors, or even in the articulated lorry transporting the peat. It is, therefore, a general safety rule that the moisture content of milled fuel peat be at least 40 % during transport to the plant and 38 % when received in the plant. This reduces the risk of dust explosion and of the spreading of fire in cases of self-ignition and also eliminates the raising of fugitive dust out of the fuel.

Peat/biomass handling operations are among the major noise sources at the peat/biomass-fired power plant.

The approach to the transportation, unloading and storage of straw is different to that of coal, other types of biomass and peat. The handling of straw for large CHP plants is almost solely based on bales, each weighing approximately 400–700 kg. Trucks carrying 20 or 24 bales transport the bales from the fields or farmers' storage area to the plant. The trucks are unloaded by a specialised overhead crane, whilst a quality check (weight and moisture) of the straw is simultaneously performed. The data from the quality checks are stored on a central logistics computer. The straw batches (10 or 12 bales per batch) are transferred either to a vacant position in the straw storage area or directly to the processing equipment. The storage is mostly fully automated and designed to hold about two to three days' full load capacity of the boiler.

The pelletised biomass used in Europe is generally wood, which has a lower calorific value and lower density than coal. It is also dusty and must be handled correctly in order to control fugitive dust emissions and manage or eliminate fire, explosion and health risks. Handling of wood pellets can result in significant dust emissions if appropriate measures are not incorporated into the design. Ignition sources are eliminated and biomass self-ignition is prevented by elimination of moisture and minimising storage and handling times. Biomass pellets can be reactive, especially if wet, and must be kept in a dry store. Generally biomass pellets are stored in dedicated silos or storage buildings where their temperature and any decomposition can be monitored.

Biomass pellets is one of the preferred biomass types when transporting long distances because of compaction, easier handling, reduction in moisture and avoidance of the need for phytosanitary treatment among others. Large volumes of wood pellets are transported by rail or ship directly to the LCP or to a harbour close to it. [85, Eurelectric 2012]

Additives

Additives and chemical treatment reagents are often used for a variety of purposes in a combustion plant. They may be used in abatement equipment, such as desulphurisation plants, and for reducing nitrogen oxides, as well as in water and waste water treatment plants. For instance, chemical reagents are used as additives for boiler make-up water and biocides are used in cooling systems.

The supplier or employer specifies the appropriate storage of these materials. As reagents can react together, the storage and handling methods applied usually involve segregating any reactive materials. Liquids are usually stored in drums or tanks in open or enclosed bunded areas, and acid- or chemical-resistant coatings are also used. Fine pulverised solids such as lime are generally stored indoors in silos, in drums or bags and with isolated drainage systems. Coarse structured solid raw materials are often stored in open storage areas. Pneumatic or mechanical (e.g. screw conveyors, bucket elevators) transportation systems are used to transport the materials.

The distribution of gases within the site is normally carried out inside pipelines, which are situated overhead, and which include good damage protection systems. Health and safety regulations govern the storage, handling and distribution of liquid or gaseous ammonia, which are used in SCR and SNCR plants to reduce NO_x emissions.

2.8.1.2 Liquid fuels

Liquid fuels are supplied by pipeline, ship, train or lorry, depending on the availability of transport systems at the oil well, refinery and LCP site. Liquid fuels are processed in refineries for direct use in engines, domestic combustion systems and LCPs. Unloading is normally carried out with pipelines.

Fuel oil is stored in vertical steel cylindrical (vented or floating roof) storage tanks. The tank capacity varies from 1 000 m³ to 100 000 m³, depending on the number of tanks and the size of the station. The tanks are generally grouped inside a bund (retention basin), which can hold all or a part of the volume in the event of a leak or other damage to the tanks (e.g. fire, explosion, pipe breakage); the actual capacity of the bund depends on national regulations and oil quality. For example, the bund capacity may be 50–75 % of the overall maximum capacity of all the tanks and at least equal to the maximum volume of the largest one. The bund must be perfectly sealed and should incorporate oil interceptors to prevent the discharge of oil into site run-off water.

Depending on climatic conditions at the site and the type of fuel oil stored, storage tanks may need to be equipped with heating systems to bring the fuel oil (in particular heavy fuel oil) up to the appropriate temperature for its transfer and in order to ensure correct atomisation in the

burner, which is an important pollution control technique. In such cases, the tanks have to be properly insulated. There are two types of heating systems which can be generally used to warm up the fuel oil: 'bottom' heaters, which warm up the entire volume of fuel oil; or 'recovery' heaters, which are located just before the suction piping and heat up the fuel oil only as it is leaving the storage tank. Light distillate oil does not need to be heated for pumping or for atomisation.

Regular checks of the tank contents to identify leaks and to check the fill level are common practice. Automatic systems, incorporating alarms, are used to check the fill level. Inertised atmospheres are occasionally used. Regular checks of the storage facilities and piping are common practice and part of good plant management.

Pipelines used for liquid fuel delivery incorporate intermediate tank storage. Fuel distribution from the site storage tanks to the burners is usually by overhead pipelines or by service trenches, or less commonly by buried pipeline. Barriers are used to protect overhead pipelines against damage. When using underground pipes, state of the art is to use double-walled pipes with automatic control of the spacing and special constructions (e.g. steel pipes, welded connections with no valves in the underground section).

If there is a risk of groundwater contamination, the storage area should be impermeable and resistant to the fuel stored. Depending on the flashpoint of the liquid fuel, there may be a risk of explosion.

2.8.1.3 Gaseous fuels

Gaseous fuels are delivered to LCPs via pipeline, either from the gas well or from liquefied natural gas (LNG) decompression and storage facilities. Natural gas from different wells varies in quality. Often gas clean-up may occur at the production site to reduce transport problems in pipelines.

The natural gas high-pressure grid in the EU-27 is approximately 235 000 km long. Figure 2.30 shows the European natural gas network in 2011. The high-pressure grid delivers gas to a low-pressure distribution grid which is 1 649 400 km long. Compressor stations (167 in total) are only used in the high-pressure grid. The purpose of a compressor station is to restore the pipeline pressure to the desired level if it is decreased too much in the pipeline. The pressure loss depends on the distance from the previous compressor station, but also on the flow rate. To ensure the contracted gas flow the pipeline, pressure has to be raised again after 100 km to 250 km depending on the local and technical situation.



Source: [111, Marcogaz 2013] [119, Italy 2013]

Figure 2.30: European natural gas network in 2011

A range of gases may be used in gas combustion plants. If the pressure of the supply pipeline exceeds the required input pressure of the LCP, the gas pressure needs to be regulated. This may take place in an expansion turbine in order to recover some of the energy used for compression. Heat from the power plant can be used to heat up the gas and thus to increase electricity output. Fuel gas is then transported in pipes to the LCP.

Gas turbines only use clean gases for direct firing. Here also, natural gas may have to be decompressed, if the pressure of the pipeline exceeds the required input pressure of the gas turbine. Adiabatic cooling of the expanded gas can be used to cool the fresh air entering the gas turbine's compressor. Fuel gases at atmospheric pressure from other sources have to be pressurised to the necessary input pressure of the combustion chamber of the particular gas turbine. Fuel gas may be also preheated.

Natural gas storage is an industrial process where gas is generally injected into an underground porous rock system or salt cavern, which can store the accumulation and then supply the gas to meet the market demand, in terms of hourly and daily flow rate. The storage gas stations include gas compression plants and processing plants.

In order to be transported by LNG carriers, natural gas is subject to the liquefaction process. The liquefaction temperature of natural gas is $-162\text{ }^{\circ}\text{C}$ at atmospheric pressure. The natural gas is liquefied and stored in tanks in the producing country before being loaded into an LNG vessel. The LNG-receiving area of the plant has, in general, a berthing area for the LNG carriers, unloading arms and a transfer line to the tanks. The LNG is unloaded from carriers and sent through a pipeline. The storage area consists of tanks where submerged pumps are placed for the movement of LNG.

The regasification area is made up of pumps for the movement and pressurisation of the LNG and of the submerged combustion and/or seawater vaporisers. The liquefied natural gas is drawn from the tanks and sent through the pipeline to the vaporisation units where the LNG is heated to reach its gaseous state. The natural gas is then injected into the transmission network which transports it to end users.

3 GENERAL TECHNIQUES TO PREVENT AND/OR REDUCE EMISSIONS AND CONSUMPTION

3.1 Applied common techniques

Techniques are described in this section if they apply to more than one combustion process or type of fuel firing described in Chapters 4 to 9. Further details are provided in Chapters 4 to 9 if the techniques apply to a specific process or to the combustion of a specific fuel perform in a specific manner.

3.1.1 General primary techniques to reduce emissions/consumption

Some techniques have a general positive and global impact on emissions and/or consumption due to their better energy efficiency or to their full integration into the combustion process.

3.1.1.1 Cogeneration or combined heat and power (CHP)

See Section 2.5.

3.1.1.2 Integrated gasification combined cycle

See Section 2.6.

3.1.1.3 Combined-cycle combustion

See Section 2.4.3.

3.1.1.4 Fuel switch or choice

The possibility of choosing a fuel or switching fuel from solid to liquid or gas, or from liquid to gas, is considered 'subject to conditions' in this document, as the technical, economic and political feasibility of a fuel switch or choice is largely determined by local circumstances. The possibility to change the fuel is also subject to a strategic evaluation of the fuel policy at a national level and to market availability.

In general, the use of fuels with a lower content of ash, sulphur, nitrogen, carbon, mercury, etc. is an option to consider.

Choosing or switching to low-sulphur fuel, keeping the other basic fuel parameters (e.g. lower heating value, ash and moisture content) within the boiler design fuel range, is a measure which can significantly reduce SO₂ emissions. In cases where supply is available, a choice or change of fuel may be a viable option. This may include fuels with high internal desulphurisation due to the limestone (or other active compounds) content of the fuel ash. For coal, 5 % limestone content is typical. For lignite and peat, desulphurisation effects may be higher than for coal, even up to 80 %, depending on the fuel and the combustion system. Also, biomass can be used for multi-fuel firing, contributing to SO_x emissions prevention. However, this measure greatly depends on the type of fuel and the abatement technique used, and therefore is discussed in Chapters 4 to 9.

Natural desulphurisation can reduce SO₂ emissions by as much as 90 %, e.g. by burning some low-quality lignites and peat with a low sulphur and a high alkaline ash content, resulting in very low SO₂ emissions, comparable to those achieved by the application of common secondary techniques.

Combustion plants located in iron and steel facilities aim at using the available process gases as much as possible, taking into account that in this sector the composition and quantities of fuels/process gases that are combusted may be highly variable. Process gases are directed to the combustion plants depending on their availability, as they are distributed in order of priority to the consuming plants in the steelworks.

3.1.1.5 Combustion modifications (process control)

Combustion-related techniques (process control) involve combustion modifications, including:

- capacity derating;
- burner modifications;
- in-furnace combustion modifications;
- air and fuel modifications (e.g. flue-gas recycling, fuel air premixing, the use of additives, fuel mixing, drying, finer grinding, gasification, pyrolysis).

Additives introduced into the combustion system support complete combustion, but can also be used as primary techniques to reduce emissions of dust, SO₂, NO_x and fuel-specific metals.

Possible techniques related to combustion modifications are given in Table 3.1. Details for these primary techniques are very specific to the fuel and combustion system applied and are given in Chapters 4 to 9. Reciprocating engine primary techniques are described in Chapters 6 and 7.

Table 3.1: Description of primary techniques for emission control

Fuels/parameters	Combustion modifications			
	Capacity derating	Air and fuel modifications	Burner modifications	In-furnace combustion modifications
Solid fuels/dust	Lower volume flow and higher oxygen surplus reduce temperature	Gasification, pyrolysis of fuel, fuel additives, i.e. low melting additives for slag tap furnace with liquid ash removal	Liquid ash removal, cyclone burner in slag tap furnace	Liquid ash removal in slag tap furnace; coarse ash control in circulating fluidised bed combustion
Solid fuels/SO ₂	Reduced temperature reduces sulphur volatilisation	Use of low-sulphur fuel and sorbent fuel additives, i.e. lime and limestone for fluidised bed combustion	Burner with separate additive injection	Injection of absorbents, i.e. limestone
Solid fuels/NO _x	Reduced temperature reduces thermal NO _x	Mixing and finer grinding of fuel and flue-gas recycling reduce NO _x production	Low-NO _x burners	Staged combustion and reburning
Liquid fuel/dust	Reduced temperature reduces slagging	Gasification, pyrolysis of fuel, additives for low soot combustion	NA	Optimised combustion
Liquid fuel/SO ₂	NA	Use of low-sulphur fuel and additives for absorption	NA	NA
Liquid fuel/NO _x	Reduced temperature reduces thermal NO _x	Flue-gas recycling reduces thermal and fuel-bound NO _x	Low-NO _x burners	Staged combustion*, reburning. Water and steam addition
Gaseous fuel/NO _x	Reduced temperature reduces thermal NO _x	Flue-gas recycling, fuel air premixing**	Low-NO _x burners	Staged combustion* **. Reburning, water and steam addition
NB: * Not applicable to existing gas turbines. ** Staged combustion is applied differently in gas turbines and furnaces. NA: Not available Source: [123, Eurelectric 2001]				

The use of additives to the fuel can be a fuel supply measure for small combustion systems or a primary combustion technique at LCP sites. LCP-integrated fuel modification techniques necessary for optimised combustion, such as fuel mixing, fuel additives, crushing, and grinding of solid fuels, are dealt with in Chapters 4, 5, 6, and 8 when applicable. Some LCP-integrated fuel-side measures currently under development are special integrated fuel preparation techniques. This includes techniques to enhance efficiency, such as the pre-drying of solid fuels, and gasification or pyrolysis of solid or liquid fuels, with the necessary syngas cleaning for combined-cycle applications (see Chapter 4).

3.1.2 Techniques to prevent and/or reduce dust emissions

During the combustion of fuels, the mineral matter (inorganic impurities) converts to ash and part of it leaves the boiler as fly ash along with the flue-gas. The particulates suspended in the flue-gas as fly ash constitute the primary particulate matter entering the dust control device. The characteristics and the amount of the fly ash depend on the fuel used, on the fuel characteristics, on the type of combustion and on combustion optimisation. The performance of the dust control device is affected by changes in the resistivity and cohesiveness of the fly ash, which depend on the fuel characteristics. The type of combustion affects the particulate size distribution in the fly ash and hence affects dust emissions. Fine particulate matter may also contain higher concentrations of metal elements than coarser particles. This is because fine particles have a greater total surface area available for metals to condense on.

Different techniques, such as electrostatic precipitators (ESPs), bag filters and wet scrubbers, are commonly used to remove dust from the flue-gas. Because mechanical dust arrestors such as cyclones and SO₃ injection cannot be used alone, these techniques are not considered or analysed as stand-alone techniques in this document. Figure 3.1 presents an overview of the dust control devices currently in use.

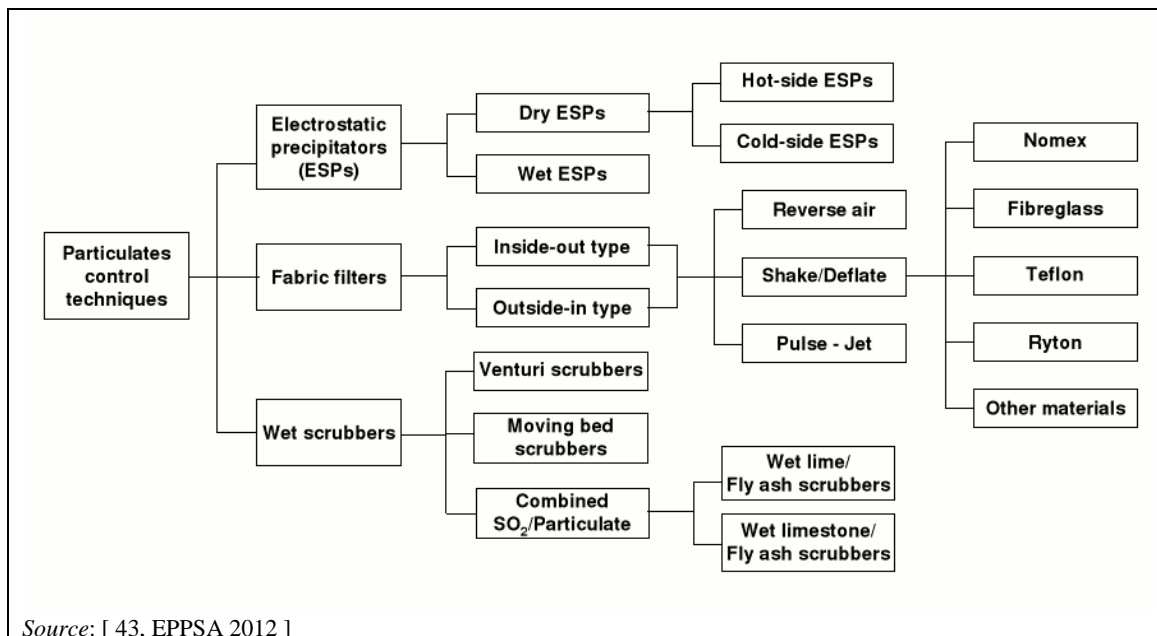

Figure 3.1: Overview of dust control devices

ESPs with fixed/rigid electrodes are the technique most widely used. Cold-side ESPs are located after the air preheater and operate over a temperature range of 80–220 °C. Hot-side ESPs are located before the air preheater, where the operating temperature range is 300–450 °C. However, bag filters, which generally operate over a temperature range of 120–220 °C, have also become increasingly important. The bags for a bag filter used in a coal combustion plant have an estimated lifetime of between 5 000 and 40 000 hours. The bags for a bag filter used for straw combustion have an estimated lifetime of between 12 000 and 16 000 hours. For ESPs, small cracks may form in the emitting electrodes after 50 000 hours of operation.

The choice between an ESP and a bag filter generally depends on the fuel type, plant size and configuration, and boiler type. Both techniques are highly efficient devices for dust removal, which can be further improved by flue-gas conditioning. ESPs plus bag filters are also applied to reduce PM₁₀, PM_{2.5} and mercury. For specific coals, the use of SO₃ injection (with or without NH₃ injection) is used in combination with an ESP to reduce dust emissions. Wet scrubbers are used far less than ESPs and bag filters as a principal technique to remove dust, and then mostly

in the US. They can have high power consumption and generally achieve lower dust removal efficiencies, especially for fine particles, than ESPs and bag filters. Wet scrubbers used for desulphurisation, however, provide co-benefits in terms of reducing dust emissions.

According to the global inventory of electric power-generating plants "UDI World Electric Power Plants Data Base" (WEPP) 2014, there are around 630 power plants that use bag filter alone or in combination with other dust abatement techniques. 48 % of them are located in North America, 23 % in European countries, 14 % in Asia, 7 % in Africa, 6 % in Australia/New Zealand and about 2 % in Latin America. The same source reports about 4 800 power plants using ESP alone or in combination with other dust abatement techniques. 53 % of them are located in Asia, 19 % in European countries, 18 % in North America, 4 % in Russia and CIS countries, 2 % in Africa, 2 % in Latin America, 2 % in the Middle East and 1 % in Australia/New Zealand.

3.1.3 Techniques to prevent and/or reduce SO_x emissions

Sulphur oxides are emitted through oxidation of the sulphur contained in the fuel. Measures to remove sulphur oxides, mainly SO₂, from flue-gases during or after combustion have been used since the early 1970s, first in the US and Japan and then, in the early 1980s, in Europe. Nowadays there are many different ways of reducing the SO₂ emissions generated by the combustion of fossil fuels.

The investment cost for a DeSO_x plant varies a lot, according to the method chosen. The operating cost mainly depends on the amount and type of reagent, water and electricity consumption, maintenance, and residues disposal costs if not reused. The DeSO_x system needs proper maintenance in order to work optimally. In addition, it is bulky and consequently additional space is needed for the combustion plant.

Flue-gas desulphurisation (FGD) techniques can be classified as shown in Figure 3.2.

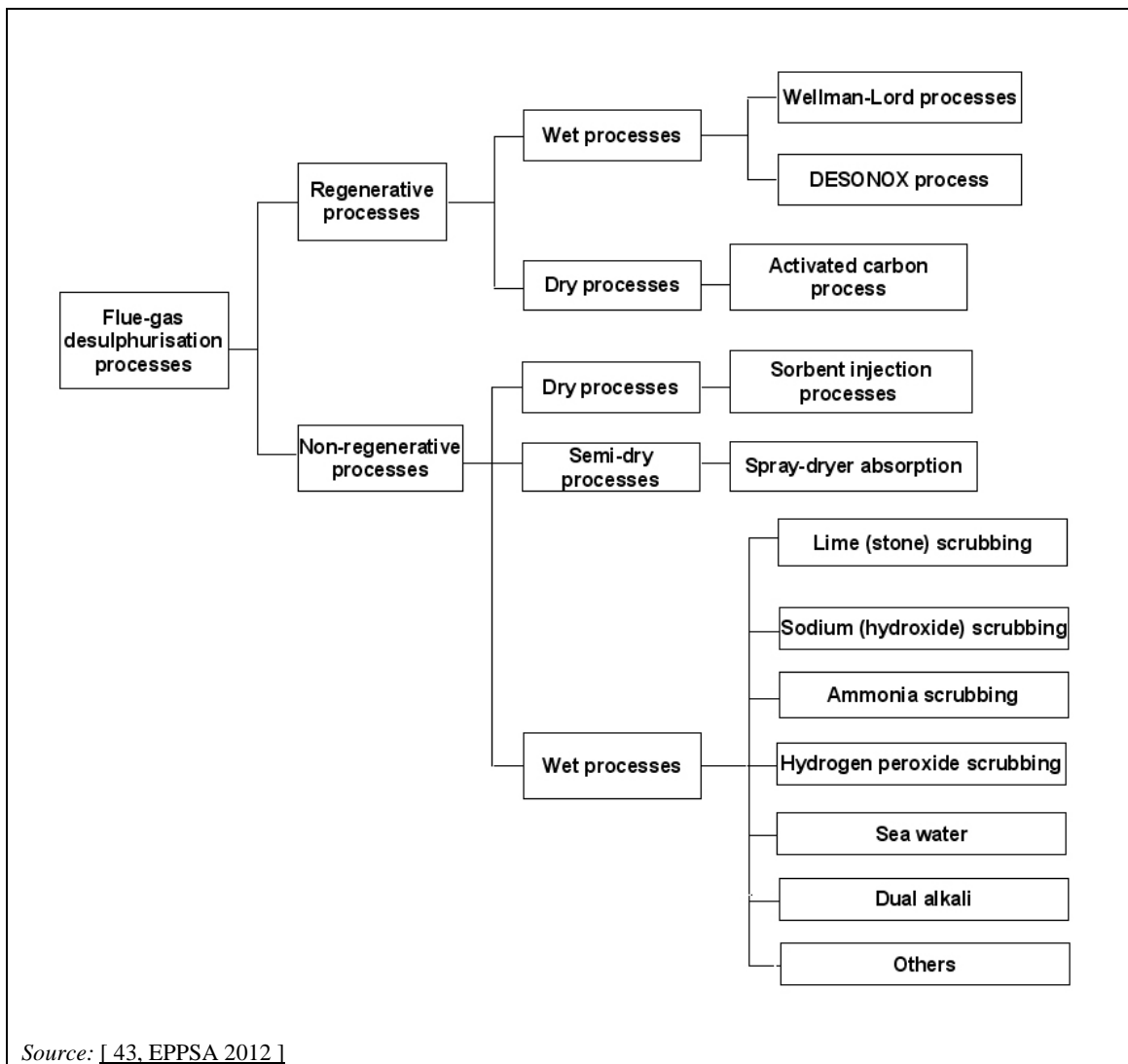

Figure 3.2: Overview of secondary techniques used to reduce sulphur oxide emissions

3.1.3.1 Wet scrubbers

Wet scrubbers, especially in limestone-gypsum processes, are the leading FGD techniques. They have about 80 % of the market share and are used in large utility boilers. This is due to their high SO₂ removal efficiency and their high reliability. Limestone is used in most cases as the sorbent, as it is available in large amounts in many countries and is cheaper to process than other sorbents. By-products are either gypsum or a mixture of calcium sulphate/sulphite, depending on the oxidation mode. If the gypsum can be sold, the total overall operating costs may be reduced.

The first successful wet limestone scrubber plant was constructed in 1972 by Mitsui Miike Engineering Company (MIMC) at the Omuta coal-fired plant of Mitsui Aluminium in Japan. The plant used lime slurry and produced sludge of calcium sulphite/sulphate and fly ash, which was disposed of in a pond. Since then, wet limestone scrubbers have become popular in the US. The penetration of this technique has taken more time in other countries, mainly because of the large land requirements for sludge disposal. The first wet limestone scrubber plant producing gypsum for a coal-fired utility boiler was constructed at the Takasago power plant of EPDC (Electric Power Development Company), which began operation in 1975. Initially the plant had start-up problems but the reliability of the operation has exceeded 99 % since 1977.

Sodium scrubbing was popular in the late 1960s in Japan. The by-product, sodium sulphite, was sold to the paper industry. The sodium scrubbing process is simple and was applied to a large number of small oil-fired boilers. Several magnesium scrubbing systems are also used in relatively small industrial boilers, mainly due to the low capital costs involved. In magnesium scrubbing systems, waste water containing magnesium sulphate can be discharged into the sea, after the removal of dust and dust-absorbed metals, as magnesium sulphate is already a constituent of seawater. The process, therefore, has an advantage over other systems if a plant is located near the coast. The by-product of wet ammonia scrubbers can be used as an agricultural fertiliser.

Dual alkali processes have been in commercial operation in the US since the mid-1970s. Wet limestone scrubbers suffered from gypsum scaling problems during their development, in the 1970s to the early 1980s, due to the lack of understanding of the scrubber chemistry and the process design requirements. Dual alkali processes were used while system manufacturers and plant operators solved the scaling problems. Recent developments in dual alkali processes, enabling the use of limestone instead of the more expensive lime sorbent, and the production of gypsum, may revive the use of this system.

The reagent in magnesium scrubbing is magnesium hydroxide, which is produced by adding slaked lime to seawater in order to enhance alkalinity, taking care to avoid significant increases of other trace elements associated with the slaked lime. The process has become popular since the early 1980s, replacing sodium scrubbing, because magnesium hydroxide has become less costly than sodium hydroxide or carbonate as the reagent.

In the ammonia wet scrubber, SO_2 is absorbed by aqueous ammonia, resulting in ammonium sulphate, a by-product which can be used as fertiliser.

3.1.3.2 Semi-dry scrubbers

There are two main semi-dry scrubber types: the spray dry scrubber or absorber and the circulating fluidised bed scrubber.

The spray dry scrubber or absorber (SDA) is a FGD technique, developed in the US and in Europe in the early to mid-1970s. The first commercial use in combustion plants started in the US in 1980, where the technique was applied to a coal-fired boiler. In the worldwide hierarchy of applied FGD systems, SDA are second behind wet scrubbers. The SDA process is well established as a commercially available technique.

The circulating fluidised bed (CFB) process has been in commercial operation in over twenty coal- and/or lignite-fired utility boilers in Germany since 1987. Since the year 2000, this technique has seen significant development as a semi-dry process for LCPs in Europe, with more than 10 plants (from 100 MW_{th} up to 1 000 MW_{th}) equipped.

3.1.3.3 Sorbent injection

Boiler sorbent injection involves the direct injection of a dry sorbent into the gas stream of the boiler. Typical sorbents include: pulverised limestone (CaCO_3) and dolomite ($\text{CaCO}_3 \cdot \text{MgCO}_3$). In the furnace, the addition of heat results in the calcination of the sorbent to produce reactive CaO particles. The surface of these particles reacts with the SO_2 in the flue-gas to form calcium sulphite (CaSO_3) and calcium sulphate (CaSO_4). These reaction products are then captured along with the fly ash by the dust control device, typically an ESP or bag filter. The SO_2 capture process continues into the precipitator, and into the filter cake of the bag filter. The residues are disposed of, for example, as landfill, although careful control is needed because they include active lime and calcium sulphite. Possible uses of these residues are under investigation.

The use of adsorbents in fluidised bed combustion systems is mainly in coal-fired plants.

Duct sorbent injection means injection of a calcium- or sodium-based sorbent into the flue-gas. The most common types of duct sorbent injection are:

- dry hydrated lime, for which the sulphur capture can be improved by humidification in some cases (depending on the flue-gas composition);
- dry sodium bicarbonate injection, which does not require humidification but may require on-site milling for improved capture;
- lime slurry injection or in-duct scrubbing, which does not require a separate humidification step.

Hybrid sorbent injection is a combination of boiler sorbent injection and duct sorbent injection to improve the SO_x removal efficiency.

SO_x control in fluidised bed combustion

When a fuel containing sulphur is combusted, sulphur dioxide and sulphur trioxide are generated. In a circulating fluidised bed, sulphur oxides can be captured by using dolomite or limestone as a bed material. Dolomite, or limestone, is calcined in the bed by the influence of heat, and the calcined lime then reacts with sulphur oxides to form calcium sulphate. The temperature of the CFB (850 °C) is optimal for calcium-based sulphur recovery.

In a bubbling bed, the combustion of gases released from the fuel mainly occurs in the freeboard zone, and the dense suspension only exists in the bubbling bed. Therefore, the efficiency of sulphur recovery is much lower in BFBC than in CFBC.

3.1.4 Techniques to prevent and/or reduce NO_x emissions

Techniques that are generally used to prevent and/or reduce emissions of nitrogen oxides are divided into primary and secondary techniques. Primary techniques allow the control of NO_x formation and/or reduction in the combustion chamber, whereas secondary techniques are end-of-pipe techniques to reduce NO_x emissions.

Nitrogen oxides (NO_x) formed during the combustion of fossil fuels are mainly NO and NO₂. NO contributes to over 90 % of the total NO_x in most types of combustion; this ratio may be lower when primary techniques are applied to reduce NO_x emissions. As already mentioned in Chapter 1, there are three different formation mechanisms for NO_x: thermal NO_x formation; prompt NO_x; and the formation of NO_x from nitrogen as a component of the fuel. A number of primary techniques are currently used in LCPs in order to minimise the formation of NO_x by these mechanisms.

With data collected by EURELECTRIC, VDEW and VGB up to 1996, and updated by EEB in 2012, an indicative overview of denitrification in Europe is presented in Table 3.2.

Table 3.2: Indicative DeNO_x (secondary measures only) at large combustion plants in the EU-28

Country	Number of sites and electrical power		Plants with DeNO _x and controlled electrical power	
	No of sites	MW _e	No of sites ⁽¹⁾	Electrical power (MW _e)
Austria	18	4852	13	3187
Belgium	31	5867	3	1220
Bulgaria	NA	NA	NA	505
Czech Republic	NA	NA	NA	380
Denmark	13	8447	10	3224
Germany	960 ⁽²⁾	91 090	150	40 800
Greece	10	6138	NA	NA
Hungary	NA	NA	NA	NA
Finland	30	5054	2	600
France	17	18 218	6	1850
Ireland	10	2955	NA	NA
Italy	79	41 873	19	19 990
Luxembourg	NA	NA	NA	NA
Netherlands	15	9632	10	8650
Poland	NA	NA	NA	1598
Portugal	6	4514	2	1856
Romania	NA	NA	NA	2290
Spain	41	19 357	NA	NA
Sweden	41	5303	11	2534
United Kingdom	26	37 718	3	4458
EU-28 (2012)	1297	26 1018	229	93 142

⁽¹⁾ Including fluidised bed combustion.
⁽²⁾ Including German industrial power plants of > 50 MW_{th}.
NB:
NA: Not available.
Source: [123, Eurelectric 2001] [120, EEB 2013]

3.1.4.1 Primary techniques to reduce NO_x emissions

There are a wide variety of primary emission reduction techniques to prevent nitrogen oxides formation in combustion plants. All these techniques aim to modify operational or design parameters of combustion plants in such a way that the formation of nitrogen oxides is reduced or so that nitrogen oxides already formed are converted inside the boiler/engine/gas turbine prior to their release. Figure 3.3 summarises the primary techniques regarding combustion modifications.

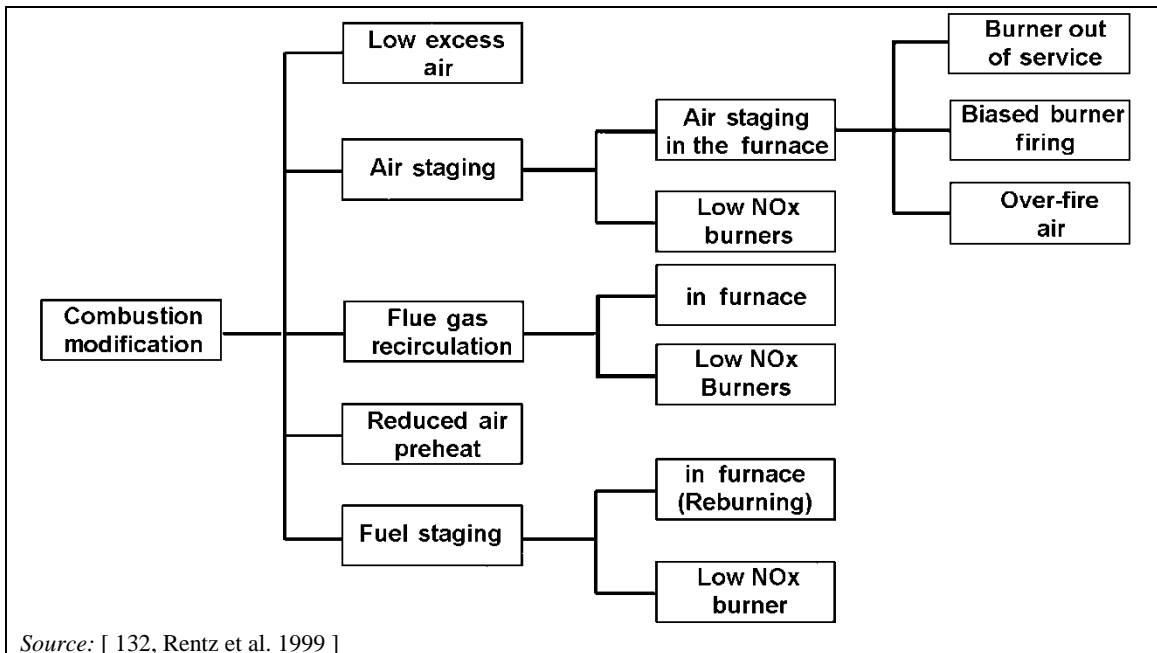

Figure 3.3: Overview of combustion modifications for reducing nitrogen oxide emissions

When combustion modifications are introduced, it is important to avoid adverse impacts on combustion plant operation and the formation of other pollutants. So the following criteria for low-NO_x operations should be taken into account:

- Operational safety (e.g. stable ignition over the load range).
- Operational reliability (to prevent corrosion, erosion, fouling, slagging, overheating of tubes, etc.).
- Minimal adverse impacts on the combustion plant's basic operating parameters (e.g. main steam flow, superheated and reheated steam temperatures, and energy efficiency).
- Ability to burn a wide range of fuels.
- Complete combustion (to reduce the carbon-in-ash levels for boilers for making fly ash saleable to the cement industry. Optimised combustion is also desired in order to avoid high emissions of carbon monoxide).
- Lowest possible pollutant emissions, i.e. avoiding formation of other pollutants, for example N₂O.
- Minimal adverse impact on the flue-gas cleaning equipment and on the other systems of the plant (fuel milling, etc.).
- Low maintenance costs.

In addition to combustion modifications, other primary techniques are also able to minimise NO_x generation such as milling in coal-fired plants and including developments in gravimetric feeders, dynamic classifiers and advanced control systems' neural networks/optimisers.

3.1.4.2 Secondary techniques to reduce NO_x emissions

Secondary techniques or end-of-pipe techniques reduce the nitrogen oxides (NO_x) already formed. They can be implemented independently or in combination with primary measures such as low-NO_x burners. Most flue-gas technologies to reduce NO_x emissions rely on the injection of ammonia, urea or other compounds, which react with the NO_x in the flue-gas to reduce it to molecular nitrogen. Secondary techniques can be divided into:

- selective catalytic reduction (SCR);
- selective non-catalytic reduction (SNCR);
- a combination of the two.

The selective catalytic reduction (SCR) technique is widely applied for the reduction of nitrogen oxides in flue-gases from large combustion plants in Europe and in other countries throughout the world, such as Japan and the US.

The selective non-catalytic reduction (SNCR) technique is another secondary technique to reduce nitrogen oxides already formed in the flue-gas of a combustion plant. It is operated without a catalyst within a temperature window which greatly depends on the reagent used (aqueous ammonia, urea or anhydrous ammonia).

The combination of both techniques is also increasingly applied with a compact catalyst system installed at the boiler outlet, after an SNCR system, in order to further complete the NO_x reduction and to limit the NH₃ slip.

According to the global inventory of electric power-generating plants 'UDI World Electric Power Plants Data Base' (WEPP) 2014, there are around 1430 power plants that use SCR alone or in combination with other NO_x abatement techniques. Of these, 52 % are plants located in North America, 32 % in Asia and 13 % in European countries. The same source reports about 230 power plants using SNCR alone or in combination with other NO_x abatement techniques. Almost 63 % of them are located in North America, about 28 % in European countries and 7 % in Asia.

3.1.4.2.1 Trade-offs between NO_x abatement, CO/dust emissions and/or energy consumption

Examples of trade-offs between NO_x abatement, CO/dust emissions and/or energy consumption are given in Section 1.3.8. These trade-offs are very dependent on the techniques/fuel used and on the plant configuration. More generally, when comparing the data for assessing the BAT candidate techniques in this document, correlations and cross-impacts between these parameters subject to potential trade-offs have been considered for deriving the conclusions and setting the associated emission levels.

3.1.5 Combined techniques to prevent and/or reduce SO_x and NO_x emissions

Combined SO_x/NO_x abatement techniques have been developed with the aim of replacing conventional FGD/SCR techniques. Some of the combined SO_x/NO_x abatement techniques have only been applied in a very small number of units or exist more or less only as demonstration plants and have not yet found a market penetration for commercial (cost) reasons. Each of these techniques employs a unique chemical reaction to remove SO_x and NO_x simultaneously. The development of combined techniques has been triggered by a major problem of conventional SCR followed by the FGD technique, which is related to the oxidation of SO₂ in the SCR reactor. Usually 0.2–2 % of the SO₂ is oxidised to SO₃. This has various effects on the flue-gas cleaning system. For low-sulphur coal for instance, SO₃ may improve the removal efficiency of a cold-side ESP. However, SO₃ usually increases the deposits and corrosion in the air preheater and gas-gas heat exchanger.

Combined SO_x/NO_x abatement techniques can generally be divided into the following categories:

- solid adsorption/regeneration (desorption);
- gas/solid catalytic operation;
- electron beam irradiation;
- alkali injection;
- wet scrubbing.

Within these categories several processes are still under development, whereas other techniques are already commercially available and in operation in a number of plants.

3.1.5.1 Solid adsorption/regeneration

This type of process employs a solid sorbent or catalyst, which adsorbs or reacts with SO_x and NO_x in the flue-gas. The sorbent or catalyst is regenerated for reuse. Sulphur or nitrogen species are liberated from the sorbent in the regeneration step, which generally requires a high temperature or reducing the gas for a sufficient residence time. The recovered sulphur species are processed, for example in a 'Claus' plant, to produce elemental sulphur, a saleable by-product. The nitrogen species are decomposed into N_2 and water by injection of ammonia or by recycling to the boiler. In other processes such as the activated carbon process, copper oxide, zinc oxide and magnesium oxide-vermiculite are involved in solid adsorption/regeneration.

3.1.5.1.1 Activated carbon process

As activated carbon has a very large specific surface area, it has been widely used as an air cleaning and waste water treatment agent since the nineteenth century. It has also long been known that activated carbon adsorbs SO_2 , oxygen and water to produce sulphuric acid. Simultaneous SO_2 and NO_x removal becomes possible by adding ammonia.

The flue-gas from the boiler is first dedusted, passed through a heat exchanger where heat is extracted for activated carbon regeneration, and then cooled in a water pre-scrubber. The gas enters the first stage of the activated carbon (dry porous charcoal) bed at a temperature of 90–150 °C. The sulphur dioxide reacts with oxygen and water vapour in the flue-gases (through catalytic oxidation) to form sulphuric acid, which is adsorbed on the activated carbon.

Prior to entering the second-stage adsorber, ammonia is injected into the flue-gases in a mixing chamber. Nitrogen oxides react catalytically with the ammonia in the second stage to form nitrogen gas (N_2) and water. The cleaned flue-gases and liberated nitrogen and moisture pass to the stack for discharge. The reduction process takes place in an adsorber, where the activated carbon pellets are transported from the top to the bottom in the form of a moving bed. The gas flows across the layers, first entering the lowest part of the bed.

The sulphur-laden activated carbon passes to a regenerator where desorption is performed thermally, by indirect heating using heat extracted earlier from the flue-gases, at a temperature of about 400–450 °C. Carbon dust is removed and make-up pellets added, prior to recycling them back to the absorber. As a result of the regeneration, enriched SO_2 gas is generated from the desorber. The enriched gas is converted, using a Claus or another process, to elemental sulphur, or sulphuric acid that can be sold as a by-product. Figure 3.4 shows a schematic diagram of the activated carbon process.

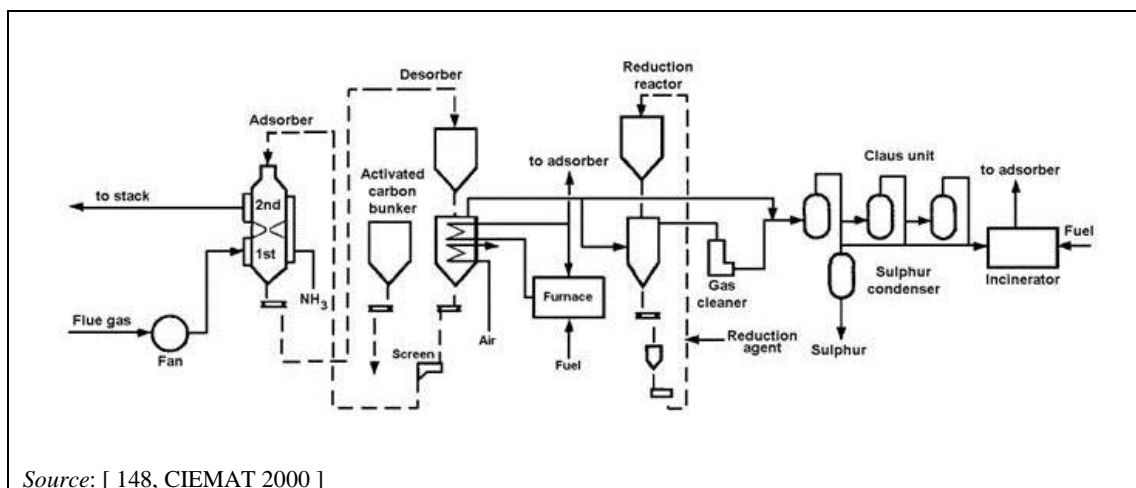

Figure 3.4 The activated carbon process

3.1.5.1.2 Other solid adsorption/regenerative processes

Other processes such as the copper/zinc oxide process are still being developed and are therefore not discussed further in this chapter.

3.1.5.2 Gas/solid catalytic processes

This type of process employs catalytic reactions such as oxidation, hydrogenation or SCR. Elemental sulphur is recovered as a by-product. Waste water treatment is not required. WSA-SNO_x (Wet gas sulphuric acid with integrated selective catalytic reduction DeNO_x step), DeSONO_x and SNRB are included in this category.

The WSA-SNO_x process employs two catalysts sequentially to remove NO_x by SCR and to oxidise SO₂ to SO₃, condensing the latter to sulphuric acid for sale. About 95 % of the sulphur and nitrogen oxides in the flue-gas can be removed. The process produces no waste water or waste products, nor does it consume any chemical, apart from ammonia for NO_x control.

In the DeSONO_x process, flue-gases are first passed through an ESP to remove particulates, followed by ammonia injection and SCR. The gases are then cooled by preheating combustion air, and reheating the fully treated flue-gases prior to release to the atmosphere. The temperature of the flue-gas is thus reduced to approximately 140 °C, which enables the catalytic oxidation of SO₂ to SO₃ and its subsequent condensation to sulphuric acid (70 %). The latter step is accomplished in a recirculating acid tower. The flue-gases are finally directed through a wet electrostatic mist precipitator and are reheated prior to release.

In the SO_x-NO_x-Rox BoxTM process (SNRB), a dry sorbent such as lime or sodium bicarbonate is injected into the flue-gas upstream of a specially designed filter arrangement. This process combines the removal of SO₂, NO_x and dust in one unit, i.e. a high-temperature catalytic ceramic or bag filter. The process requires less space than conventional flue-gas cleaning technology. The SNRB process aims to remove up to 90 % of the SO₂ and NO_x and at least 99 % of the dust, but no information is available about whether this process is actually applied to a large combustion plant. Therefore, no information on the general performance of the SNRB process is given.

3.1.6 Techniques to prevent and/or reduce metal emissions

Metals bound in most fossil fuels are liberated during combustion and may be released to the atmosphere on particles or as vapours. The metals which are of most concern with respect to fossil fuel utilisation are: As, B, Cd, Cr, Cu, Hg, Mo, Ni, Pb, Se, V and Zn. Some of these metal elements are very toxic, especially if they are present in sufficient quantities.

Metals are partitioned into several output streams, mainly combustion residues such as fly ashes but also flue-gas, which enter downstream pollution control devices (Figure 3.5). Because of the large quantities of fuel consumed in energy generation, large amounts of potentially hazardous metals can be released into the environment. Most metal elements are associated with dust. Volatile elements preferentially condense onto the surface of smaller particles in flue-gas streams because of the greater surface area. Hg is a highly toxic metal which may escape capture by flue-gas control devices and which occurs in some waste fractions being co-incinerated in combustion plants but also in coals, depending on their origin. Hg is emitted, to a large extent, gaseously (see Figure 3.5).

An adequate method for obtaining data on emission values and on the behaviour of metals during combustion and flue-gas cleaning is to establish a mass balance across the total combustion plant considered (Figure 3.5). Metal mass balance investigations have been carried out for various types of large-scale coal- and/or lignite-fired power plants [149, Clarke et al. 1992], [150, Maier et al. 1992], [151, Rentz et al. 1996], [152, Martel, C. 1998]. In this figure, the oxidising effect SCR may have on elemental mercury is not considered.

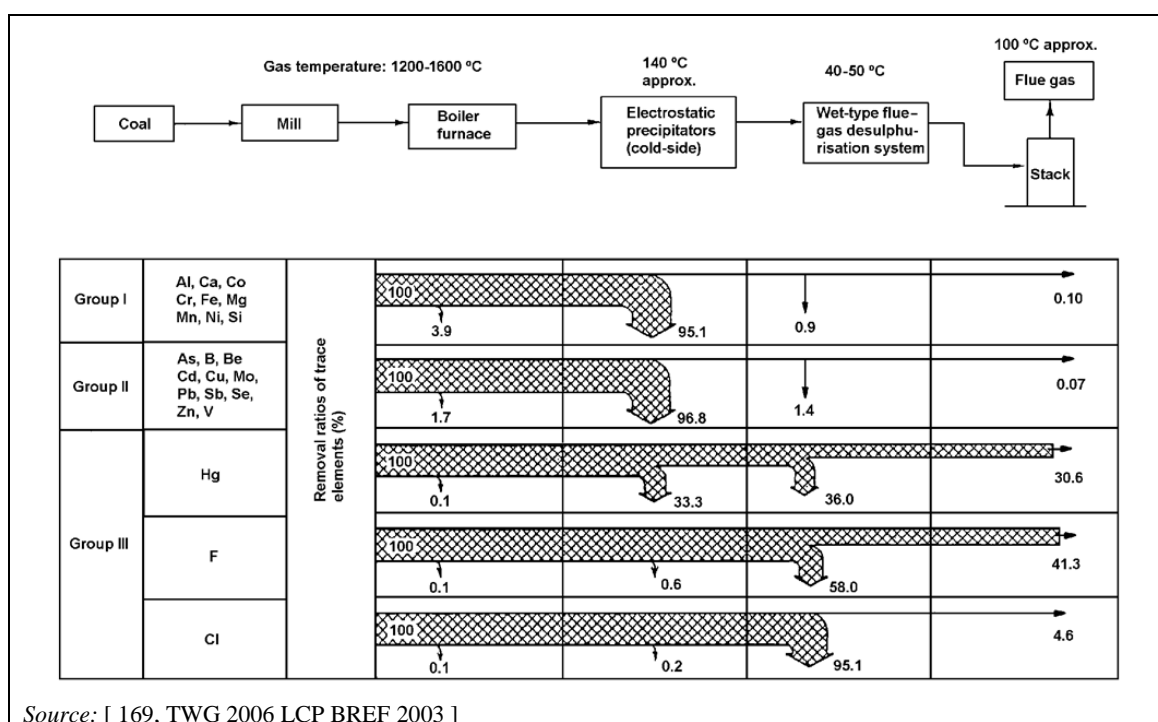

Figure 3.5: Mass balance of metals, fluoride and chloride in coal-fired combustion plants

Because volatile metal elements are more concentrated in the fine-grained dust material carried downstream from the combustion chamber, the emission of these elements depends more on the efficiency of the gas cleaning system than on the method of fuel conversion.

Several control techniques have been developed which are theoretically capable of removing a large portion of certain metals from flue-gas. These systems can generally be divided into two categories:

- techniques that are commonly used to remove dust, SO_x and/or NO_x emissions;
- techniques that have been developed expressly to remove trace elements from the flue-gas.

3.1.7 Techniques to prevent and/or reduce emissions of CO and unburnt hydrocarbons

The emissions of unburnt gases, which can be divided into two main groups: carbon monoxide (CO) and hydrocarbons (C_xH_y), can be prevented/reduced by advanced combustion techniques. Emissions of CO and unburnt hydrocarbons are a consequence of incomplete combustion and can be caused by excessively low combustion temperatures; too short a residence time in the combustion zone; or by an inefficient mixing of the fuel and combustion air, leading to local areas of oxygen deficiency and relatively uneven fuel particle size distribution.

Carbon monoxide is the most important unburnt gas. It is a stable compound even at high temperatures if there is no oxygen present. Hydrocarbons, on the other hand, can be decomposed and form soot at high temperatures in an oxygen-poor atmosphere. In general, it is possible that emissions of unburnt hydrocarbons may be generated when a low combustion zone temperature and inefficient mixing of fuel and air occur together.

3.1.8 Techniques to prevent and/or reduce halide emissions

Natural sources, the sea in particular, are the major source of chlorine, bromine and iodine in the atmosphere. Human activities, especially industrial sources such as aluminium manufacture, are the major global source of fluorine emissions. In many countries, the combustion of fossil fuels is the largest source of chlorine (as HCl) from human activities and may also be a predominant source of fluorine (as HF). Emissions of halides from combustion are in the form of highly soluble acidic gases, which can contribute to acid rain.

The emission of halides depends on a number of factors: the initial halogens content of the fuel and the form in which they are present, the combustion conditions (temperature, residence time, etc.), and the use of various pollution control techniques. Those techniques originally designed, for instance, to control emissions of SO_x, such as limestone addition to the boiler and FGD, can be especially effective in reducing emissions of the acidic halide gases. With rotating gas heat exchangers, HF bypasses FGD systems at a rate of ~50 %.

3.1.9 Techniques to reduce greenhouse gas (GHG) emissions from large combustion plants

Various methods, processes and technologies to reduce greenhouse gas emissions from fossil-fuel-fired combustion plants, especially for the reduction of CO₂ emissions, are the focus of many projects linked to the implementation of stringent climate change policies. Article 36 of the IED establishes for all plants of > 300 MW_e a legal requirement to assess certain conditions related to the future feasibility of carbon capture and storage, and, in the event of a positive assessment, to ensure the retrofittability to meet the necessary conditions for CO₂ capture.

CO₂ emissions reduction in large combustion plants is regulated in Europe through the EU Emissions Trading System (EU ETS).

Some GHG of less global importance but still relevant for the combustion sector, such as N₂O, can be generated at FBC boilers. The combustion of older fuels leads to higher levels of emissions (e.g. N₂O emission levels from anthracite combustion are higher than N₂O emission levels from lignite combustion, which are higher than N₂O emission levels from biomass

combustion). The techniques to prevent or reduce such emissions are described in Section 5.1.3.6.

3.1.10 Water use and techniques to reduce emissions to water

A large combustion plant requires considerable water for producing process water and technical water, cooling, energy generation, waste water treatment, and sanitary purposes. Water consumption varies depending on the processes involved.

The water used may be obtained from the sea, rivers, lakes, etc. and it is possible to use both seawater and water of a reduced quality for many of the processes. The feed water for the steam cycle needs to undergo water treatment to reach the quality needed for deionised water. Seawater can be used for feed water, cooling water or even for desulphurisation. Initiatives to reduce water consumption largely depend on the source of the water. The technical water and waste water from water treatment may be reused for the desulphurisation plant.

It is possible in coastal areas to use seawater that has been desalinated by reverse osmosis. The process is normally based on the following process:

- seawater intake;
- filtering by self-rinsing filter;
- filtering by sand filters;
- filtering by cartridge filters;
- reverse osmosis and recovery of energy from the concentrate.

[88, Denmark 2013]

Section 1.3.3 gives an overview of the different sources of waste water that can be found in a large combustion plant. The waste water encountered in combustion plants is composed of polluted water arising from the various LCP processes and rainwater from the site. This water may have to be treated in waste water treatment plants, where a reduction of pollutant concentrations is achieved. This section outlines the techniques that are normally used to treat the contaminated waste water streams before they can be discharged to the aquatic environment.

The amount and the quality of the waste water and, correspondingly, the configuration of the waste water treatment plant which is appropriate for the needs of a particular LCP's effluents are site-specific and depend on many parameters, including the:

- type and composition of fuel;
- type of storage facilities for fuel and chemicals;
- type of fuel preparation;
- type of combustion processes;
- type of cooling systems;
- type of chemical conditioning applied for boiler water and cooling water;
- quality of raw water available;
- type of water treatment systems;
- type of flue-gas treatment systems;
- nature of combustion by-products (fly ash, wet ash, FGD gypsum, etc.); and
- management practices (disposal, sale).

The individual waste water streams generated by the various operations in an LCP include:

- process waste water, in particular waste water from the FGD unit;
- collected rainwater run-off and firefighting water;
- sanitary waste water.

Due to their different compositions and quality (pollutants' characteristics and concentration), the above-mentioned streams are usually collected by separate drainage systems and are directed to separate destinations for further treatment in dedicated waste water treatment plants (sanitary waste water in biological waste water treatment plants, and process waste water and contaminated rainwater run-off in industrial waste water treatment plants).

The clean collected rainwater does not need to be treated and can be discharged directly to the receiving water or used as fresh water for the plant's needs. [121, Eurelectric 2012].

The design of the LCP site's drainage systems is very important, as by employing well-designed drainage systems the waste water management is optimised, achieving economies in water consumption and in the design and operation of the waste water treatment plant.

Waste water is designed to flow, as far as possible, by gravity through the drainage systems to the various components of the waste water treatment plant, in order to avoid intermediate pumping and the associated energy consumption.

Waste water streams vary greatly in flow rate. Depending on their origin, the waste water streams contain different substances:

- solid substances (e.g. suspended solids);
- fluid substances (e.g. oils, oil-water emulsions);
- water-soluble substances (organic, inorganic).

The waste water streams encountered most often in an LCP are listed below:

- waste water from raw water treatment plants;
- waste water from the cooling circuit systems;
- waste water from other sources in the steam generation process;
- waste water from flue-gas cleaning systems;
- acid washing water;
- sanitary waste water.

Inventory management tools give detailed information on the location, production, environmental circumstances, emissions, etc. of the installation and thereby help detect emissions that can be prevented or reduced.

Relevant basic data on the composition and quantity of waste water are compiled in a stream inventory. The emitted streams are listed respective to their source, i.e. the production process from which they originate. This is a key element in assessing their degree of contamination and the nature of the contaminants, as well as the possibilities of reduction at the source. Stream inventories may be the basis for waste water segregation and water treatment strategies. Waste water streams that are typically segregated include surface water run-off, cooling water, and waste water from flue-gas treatment.

Relatively uncontaminated water (e.g. from cooling water blowdown) can often be reused for other purposes requiring water of lower quality (e.g. for cleaning or flue-gas treatment). The recycling is limited by the quality requirements of the recipient stream and the water balance of the plant. Some waste water streams are usually not recycled (e.g. seawater used in cooling systems). The optimum choice of the cooling system depends on the local conditions. Waste water from wet FGD is sometimes recycled after treatment (US EPA 2013). Water recycling is not applicable to waste water from cooling systems when water treatment chemicals and/or high concentrations of salts from seawater are present.

A technique to reduce water usage and the volume of contaminated waste water discharged is the handling of bottom ash from the boilers. Dry hot bottom ash falls from the furnace onto a mechanical conveyor system and is cooled down by air or water in a closed cycle. No water is used in direct contact with the ash for cooling or transportation. Dry ash handling is a technique also described in Section 3.2.5 (Optimisation of bottom ash quality) and proposed as a new source performance standard by the US EPA.

3.1.10.1 Waste water from raw water treatment plants

Typically, raw water is pretreated before being used in different areas of the LCP. The types of pretreatment carried out are softening and demineralisation. These pretreatments typically generate the following waste waters.

The waste waters from softening plants are:

- spray water from belt strainers (cleaning of surface water);
- filtrate from sludge draining (without chemical additions);
- filtrate from sludge draining (after flocculation and precipitation);
- back flushing water from sand filters.

The waste waters arising from various parts of the softening plant are usually recycled back into the process.

The waste waters from demineralisation plants are:

- ion exchange (resins) regeneration effluents;
- reverse osmosis concentrates;
- ultrafiltration concentrates.

3.1.10.2 Waste water from cooling circuit systems

The waste water from cooling circuit systems mainly results from the blowdown of wet cooling towers and the occasional drainage from the evacuation of the cooling towers basin. In once-through cooling systems' inlet filter screen washings, cooling water discharge temperatures and the concentration of biocides or other additives are considered.

Emissions from all types of cooling systems, including LCPs, to the environment are dealt with in detail in the Industrial Cooling Systems BREF and are not included in the scope of this document.

3.1.10.3 Waste water from steam generation processes

The waste water from steam generation processes mainly includes:

- blowdowns from drum-type steam generators;
- laboratory waste water and sampling;
- discharges from the water-steam cycle;
- discharges from district heating systems;
- condensate polishing plant regeneration effluents;
- ash and slag handling and removal systems' effluents;
- boiler chemical cleaning effluents;
- boiler wet conservation effluents;
- wash water of steam generators, air heaters, gas heaters, ESPs, DeNO_x, FGD plants and various other equipment;
- oily effluents (dewatering of fuel oil storage and daily tanks, run-off from heavy fuel oil and/or gas oil treatment systems, turbine or diesel engine houses, transformer areas, etc.).

3.1.10.4 Waste water from flue-gas treatment systems

All wet-type flue-gas cleaning systems produce waste water that, due to the fuel and materials used, contains metals among other components. One of the main sources of waste water in this context is the wet limestone scrubber that is used in a large number of combustion plants for desulphurisation of the flue-gas, although this water volume can be reduced by using fuels with a lower chlorine content and by designing the absorber to operate at a higher chloride concentration. This results in a reduction in the purge to the waste water treatment plant, which in turn reduces emissions to water. An example of a conventional waste water treatment system is presented in Figure 3.6, but it is noted that there are many different types of systems, depending on the different national regulations, the type of fuel and site-specific factors.

The pH value of FGD waste water is increased in order to precipitate metals. This is generally achieved using either lime milk or caustic soda, causing the formation of metal hydroxides. By adding flocculants (iron(III) chloride), flakes are formed. The addition of coagulation aids (polyelectrolytes) allows the agglomeration of individual flakes, so that a greater flake formation ensues. The sludge is then pre-sedimented, drained and disposed of or co-combusted in the case of slag tap combustion. Part of the 'thin' sludge is recycled to the flocculation stage where the sludge particles serve as initial crystallisation nuclei promoting more rapid flocculation.

The treated waste water from the pre-sedimentation stage can be supplied to a baffle plate thickener for further sedimentation. The suspended micro-particles deposit on the inclined baffle plates. The sludge falling off the plates is gathered at the lower point of the baffle plate thickener and can also be recycled. The cleaned waste water is fed to the drain via the overflow of the baffle plate thickener, provided the regulatory limit values are met. In addition, if the pH value is required to be between 6 and 9.5, the water is neutralised. Although it is generally not necessary, the content of ammonia in the waste water may lead to it first being fed to an ammonia stripping plant before it is discharged to the drains. In some processes, e.g. with a higher input of Hg from the co-combustion of wastes, it is customary to also add (organic) sulphide after the addition of lime milk, thereby precipitating the metals as sulphides, which is more effective than using hydroxide. The disadvantage is that the metal sulphides (greater quantities) need to be disposed of, as by co-combusting these residues the sulphur would be released as sulphur dioxide and Hg would be released again.

Various plants treat FGD waste waters differently. While some of them use flocculants and flocculation aids for example, others use only flocculation auxiliaries and organic sulphide. There are, however, also operators who use flocculants, flocculation auxiliaries and organic sulphide.

In the example shown in Figure 3.6, FGD waste water is pre-neutralised in an agitator with the aid of lime slurry. The pH is further increased by additional dosing of lime slurry in the second reactor. Initial flocculation and settling of heavy metal hydroxides occur in the circular concentration reactor tank. Polyelectrolytic solution is fed into the supply line to the concentration reactor tank, in order to avoid repulsion between hydroxide particles and to accelerate sedimentation.

The treated water, with a pH of 6 to 9, may be transferred from the upper zone of the circular concentration reactor tank to the main water inlet. If the pH is above 9, it is corrected with an acid additive, e.g. hydrochloric acid. Part of the slurry withdrawn from the concentration tank is fed as contact slurry to support flocculation in the first agitator. This slurry acts as an accelerator for the precipitation of the hydroxides. Most of the slurry from the agitator is temporarily stored in a slurry container, dewatered in a filter press and finally stored in a bunker prior to disposal.

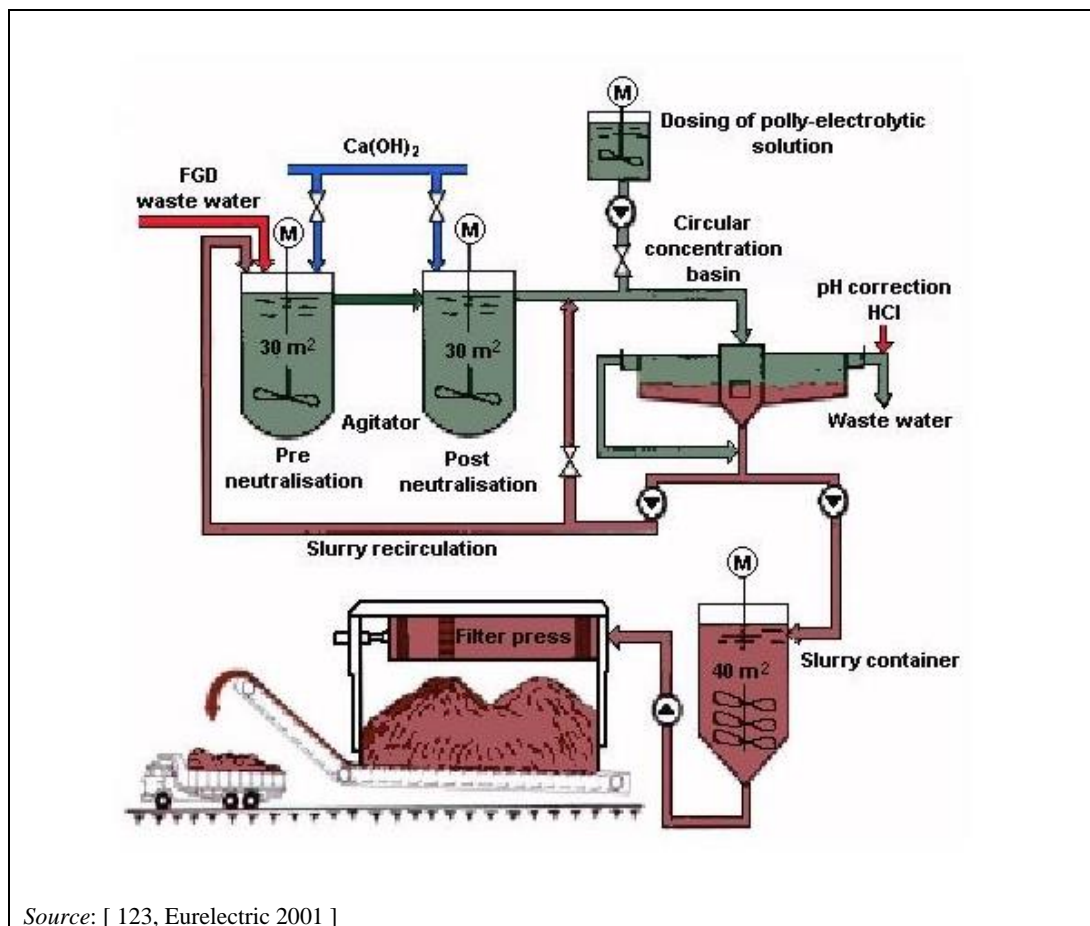

Figure 3.6: FGD waste water treatment plant

Two-stage precipitation processes (see Figure 3.7) are widespread in FGD waste water treatment. Waste water from FGD first reaches an oxidation stage, in which conversion is generally accomplished with sodium hypochlorite (NaOCl), particularly mercury dissolved into Hg(II) . This is followed by the gypsum desaturation stage. Here, by the addition of calcium hydroxide (Ca(OH)_2), the pH of the waste water is raised and iron(III) chloride (FeCl_3) may be added for flocculation. With the addition of a flocculant, a sedimenting sludge is formed, which is then deposited in a first sedimentation stage. A portion of this sludge from the sedimentation

is recirculated to improve sedimentation capability. This step can, for example, be a circular clarifier whose efficiency can be increased if necessary by the incorporation of lamellae. The deposited slurry (about 99 % of the total sludge accumulation) consists mainly of calcium sulphate and can therefore be used further as a resource.

The clear effluent of the first sedimentation stage then enters the metal removal stage. Here, by the addition of organic sulphides, the metals are precipitated as sulphides, and the pH may be further increased by the addition of calcium hydroxide.

The sedimentation capability of the metal sulphides is improved by contact between the sludge and the polymers. In the second stage of the two-stage procedure only a small amount of sludge is accumulated (about 1 %), which must be disposed of. The same construction of both sedimentation stages offers the advantage that the system can also be operated as a single stage, for example during times of revision. Another advantage of a two-stage procedure is that the gypsum sludge and the mercury sludge accumulate separately.

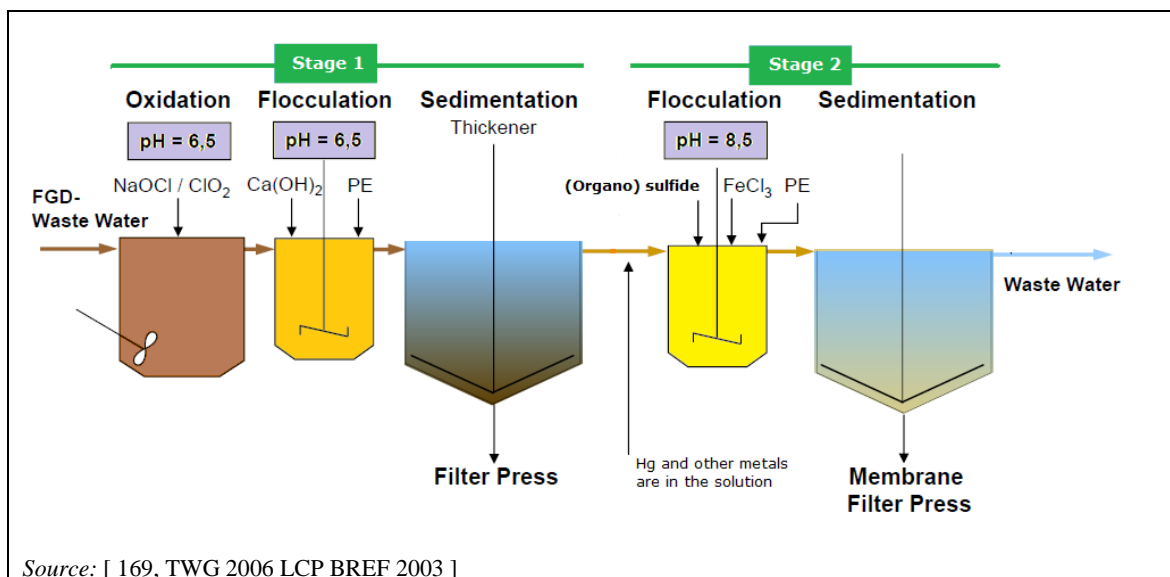
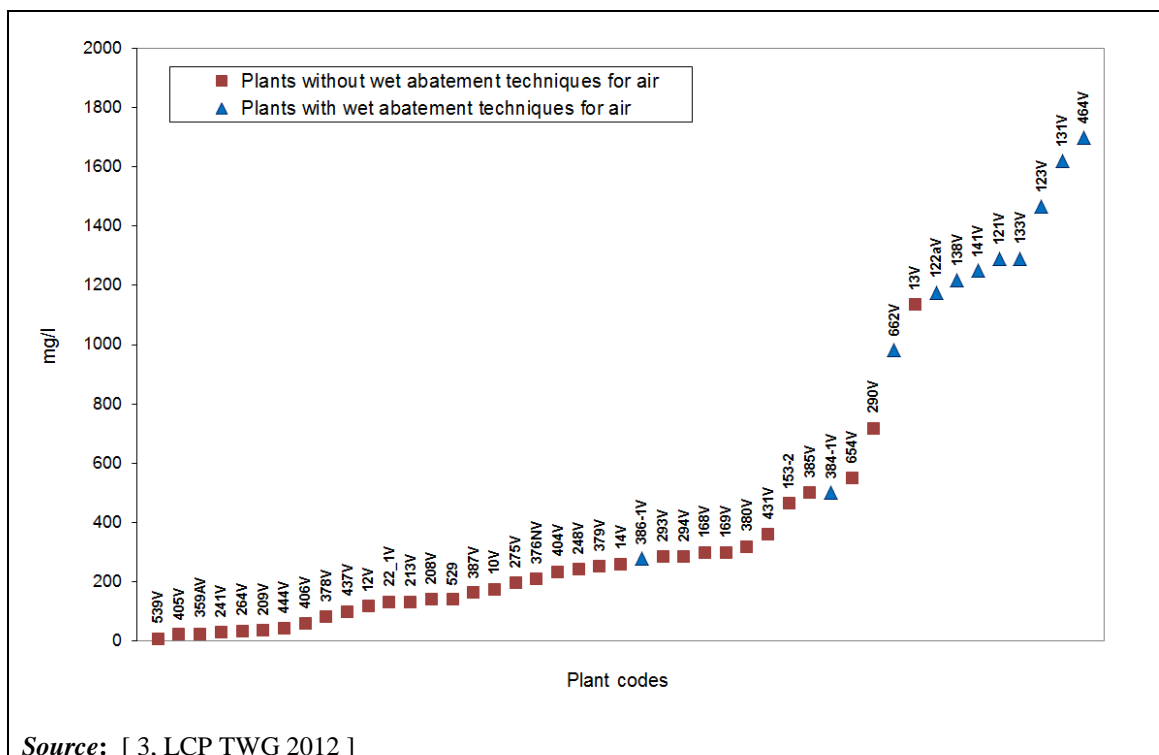

Figure 3.7: Two-stage waste water treatment plant

ZLD (zero liquid discharge) is a combination of techniques that results in no waste water discharges. Depending on plant-specific conditions, ZLD may be achieved for different waste water streams and by using different combinations of techniques. After the neutralisation and sedimentation unit (pH adjustment, ferric co-precipitation, flocculation, clarification, etc.), a Softening-Evaporation-Crystallisation (SEC) system can be installed. The products of this system are high-quality water, to be recycled, and salts, to be disposed of. Evaporation allows plants to recover clean water for reuse, thereby reducing water usage. A few plants worldwide use evaporation, including larger plants (e.g. Plants 211/212 (418+433 MW_{th}) and Plant 253 (1420 MW_{th})). However, evaporation is energy-intensive, which may offset the environmental benefits. For new FGD applications, the design can be optimised for the ZLD concept, taking into account the possible additional cost and decrease in energy efficiency, by reducing the FGD purge flow rate.

Figure 3.8 and Figure 3.9 show that, for sulphate and mercury emissions to water for example, there is differentiation between plants operating with a wet abatement system for air pollutants (wet FGD, FG condenser) and those operating without.



Source: [3, LCP TWG 2012]

Figure 3.8: Yearly sulphate concentrations in direct emissions to water – Comparison of plants with and without a wet abatement system for air pollutants

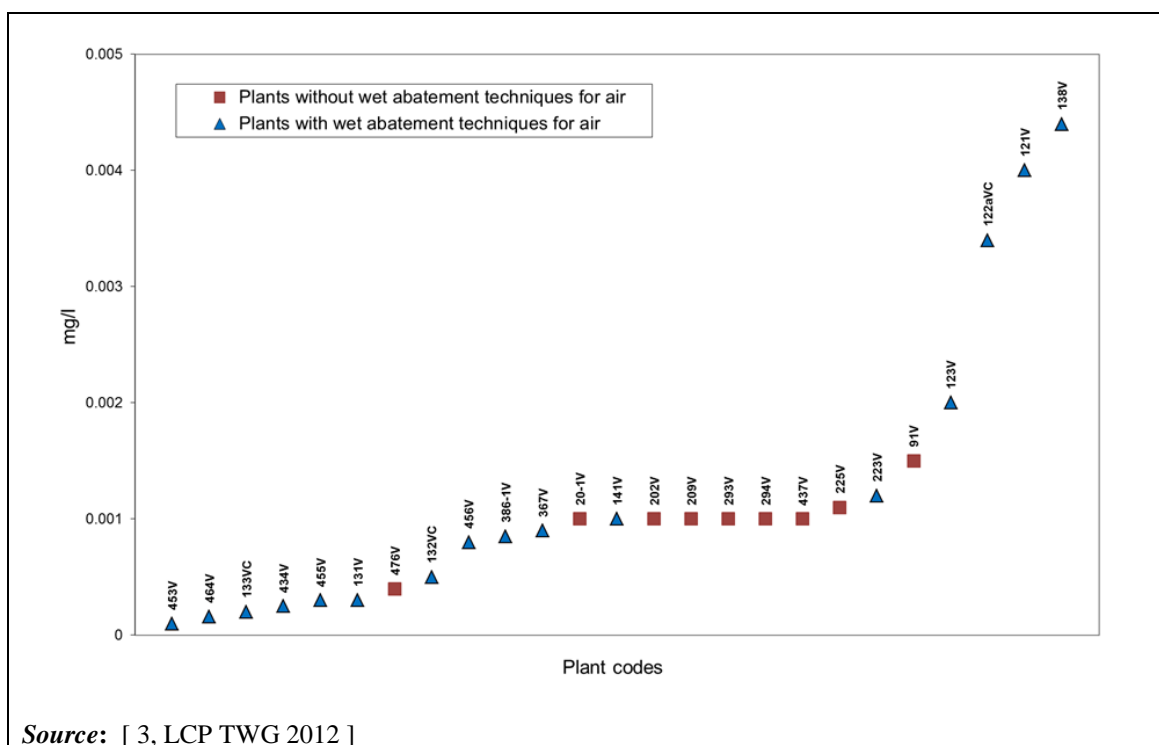

Source: [3, LCP TWG 2012]

Figure 3.9: Yearly mercury concentrations in direct emissions to water – Comparison of plants with and without a wet abatement system for air pollutants

The reported average levels of the direct emissions to water for each category of plant (i.e. those fitted with a wet abatement system for air pollutants and those without) from a set of plants operated in Europe are given in Table 3.3. In this table, no distinction is made concerning the type of fuel burnt or the type of combustion plant. The ranges include emissions from coal-fired

plants (which represent the majority of plants fitted with wet abatement systems), biomass-fired plants, and gaseous- or liquid-fuel-fired plants for those not fitted with such abatement systems. The plants themselves are boilers, gas turbines or engines. The concentrations of pollutants emitted by plants fitted with a wet abatement system are generally higher, especially for metals.

Table 3.3: Yearly emissions to water

Parameters	Unit	Flue-gas treatment system used	
		With wet abatement	Without wet abatement
As	mg/l	< 0.048	< 0.028
Sb		< 0.0051	< 0.02
Pb		< 0.1	< 0.1
Cr		< 0.083	< 0.08
Co		< 0.005	< 0.008
Cu		< 0.06	< 0.13
Ni		< 0.05	< 0.06
Mn		< 0.237	< 0.35
V		< 0.015	< 0.037
Cd		< 0.01	< 0.4
Tl		< 0.034	0.001
Fe		< 3.85	< 2.4
Hg		< 0.004	< 0.0015
Zn		0.47	< 0.34
F		< 15.2	< 9.9
Cl		< 18 250	< 5525
TOC		< 34.8	< 37.4
Total suspended solids (TSS)		< 41	< 126
Total P		< 2	< 1.89
Sulphate as SO ₄		< 1704	< 1135
Sulphide as S		< 0.3	< 0.89
Sulphite as SO ₃		4.8	< 5
Total N		0.7–303	< 73.5
AOX		< 0.95	< 0.225
THC		< 1.5	< 7

Source:[3, LCP TWG 2012]

3.1.10.5 Acid washing water

Coatings caused by corrosion on the boiler water/steam side and in the condenser are cleaned regularly to ensure effective heat transfer. This can be carried out mechanically, for instance passing foam rubber bullets through the condenser, and supplemented by acid washing. Acid washing is often performed by adding pure acids directly into water in the tanks. The generated waste water from the tanks is acidic and requires neutralisation or disposal as hazardous waste due to its high concentration of metals. For the condenser, removal of coatings is carried out annually or even more seldom. Acid washing of the boiler is carried out at the commissioning of the boiler and then only a few times in its lifetime. [88, Denmark 2013].

3.1.10.6 Sanitary waste water

Sanitary waste water includes waste waters originating from toilets and canteens. Current flows are usually estimated at approximately 75 l/person/day. Emissions are characterised by a high organic content.

3.1.10.7 Other waste waters

Surface run-off water arises from the contamination of rainwater collected from building roofs, paved areas and fuel storage areas (e.g. coal stockpiles). The contamination of rainwater occurs when materials such as dust (coal particulates) from fuel storage, surface deposition, etc. or oils are washed into the drainage system. The contamination of surface water can be prevented or minimised by the use of sedimentation basins and good practice in the storage of fuel and other raw materials, as well as by good maintenance and cleaning of the whole plant.

Surface run-off water may be collected separately. After a sedimentation step or chemical treatment, it may be reused for other purposes in the production process, for instance in water sprays to prevent dust formation from the storage of solid fuels.

In combustion plants, there are many other sources of waste water. Examples are: liquid effluents from the cleaning stations for trucks delivering fuel (e.g. trucks transporting peat) and other raw material; sealing water from pumps; and waste water from general operations, including the cleaning of equipment, floors, etc. These liquid effluents are normally collected and treated. Water from the sanitary system is normally discharged to the public sewerage system.

To reduce the concentration of water pollutants, end-of-pipe techniques such as neutralisation, flocculation, sedimentation and filtration may be used. These techniques are normally used together in a final or central on-site waste water treatment plant.

3.1.11 Techniques to control releases to land/soils and for the management of residues

When sludges and solid residues from flue-gas and waste water cleaning in LCPs cannot be utilised, or whenever the current production exceeds demand, the surplus has to be disposed of in an environmentally responsible and sound way (e.g. by applying the results of the Environmental Impact Assessment (EIA) studies conducted). Acting in this way, the appropriate choice of site, disposal method and monitoring ensures that this surplus can be deposited without detriment to the environment. In common with other powdered materials, guidelines for the manipulation (including transport) of ash ensure the efficient protection against accidental exposure to dust. The aim is always to obtain by-products from the residues that can be used in other industrial sectors, for example as building material.

The sludges and other residues from LCPs can be subdivided into sludge from water and waste water treatment and residues from flue-gas desulphurisation and flue-gas dust precipitation. Another generated residue consists of matter screened from surface waters that is encountered on the rakes and screening facilities for the drawing-off of water.

The organic matter collected at the cooling water intake can be used as an energy source or composted and used afterwards to improve soil quality. Residual matter must be deposited. Sludges from the treatment of waste waters from FGD plants can possibly be reused as reaction agents in the FGD plant, due to the calcium components. They are also used as additives in coal-fired combustion plants to improve the ash melting behaviour.

Sludges from the treatment of raw waters, such as surface water, are decarbonised and thus have a high content of calcium carbonate (e.g. 30 % or more). Besides the above-mentioned implementation in flue-gas desulphurisation and as an additive in coal boilers or other areas where calcium additives are used, these sludges can be useful as calcium fertiliser and for soil improvement in agriculture.

Residues from flue-gas desulphurisation, such as FGD gypsum and ammonium sulphates, contain calcium and sulphur, which are used for fertilisation and in soil improvers in agriculture, among other uses (e.g. construction sector). Only 0.1 % of residues from SDA are currently used as fertiliser (see data from ECOBA), mainly due to metals (e.g. Cd, Hg). SDA products are also used specifically as an underground filler, e.g. to stabilise underground mines. Other desulphurisation products, such as sulphur or sulphuric acid, are only produced in small quantities and are used exclusively in the chemical industry.

Residues from flue-gas dust removal are typically ashes, such as boiler slag from wet-bottom furnaces; bottom ash from dry-bottom furnaces; and fly ash from coal-fired and lignite-fired power plants. In fact, the utilisation of coal ash as a replacement for minerals or manufactured products saves the extraction of raw materials, while preserving and conserving natural resources, as well as reducing energy consumption and the emission of carbon dioxide (to the extent that one tonne of fly ash replacing cement saves approximately 600 kg of CO₂).

Owing to its good filtering properties, about 60 % of the bottom ash is used in road construction and other surfacing and landscaping work. About 70 % of fly ash is used in the manufacture of cement, concrete and concrete products, in which it is valued for its building properties. It is also used in the production of mortar, bricks, masonry blocks, paving and mining mortar.

Ashes from lignite-fired power plants are mostly used as a leach-free stabiliser mixed with waste water from FGD plants for the filling of exhausted open-pit mines. Part of the ash is used for recultivation and surface covering. Certain qualities of lignite fly ash make it suitable for use in concrete manufacture. There are also many other possible uses for ashes and for ashes from fluidised bed combustion plants.

In summary, techniques to control releases to soil cover flue-gas and waste water cleaning techniques, as well as techniques for residue and by-product utilisation, which result in a reduction in the amounts of waste that would otherwise have to be disposed of in landfills. With the increasing degree of utilisation, the quantity of waste that has to be disposed of is reduced, which means the consumption of landfill volume becomes lower. The utilisation of by-products may thus serve for soil protection and to conserve resources. However, care should be taken on critical parameters which may need monitoring, such as long-term leaching behaviour, stability of residues and monitoring and reporting of the quality of the residues. Therefore, unavoidable and non-utilisable mineral residual waste may still be disposed of to landfill.

3.1.12 Techniques to reduce noise emissions

Most EU countries have their own environmental noise regulations.

Typically, the noise criteria are based on different area types or specific environments (residential, commercial, industrial, etc.). These levels usually differ depending on the affected area (residential or business) and the time of day (daytime, typically 7.00 to 22.00, or nighttime, typically an eight-hour period between 22.00 and 7.00, e.g. 22.00 to 6.00 or 23.00 to 7.00). The operator of a plant usually has to give information on noise dissemination and measures taken for noise abatement. Since most plants operate continuously all day and night, the target noise levels during the night will determine the techniques for the whole site. In case of impulse noise, it is a common practice to add 5 dB(A).

The environmental noise requirement is defined with a noise receptor outside the project property boundary line. Also, existing background noise must be taken into account when defining the noise impact of a new combustion plant.

The main noise sources of thermal power plants are: fans (including inlets, outlets, stacks and enclosures), pumps, turbines, engines, steam systems, buildings (including windows and ventilation systems), cooling towers and transformers.

Effective reduction of noise emissions is achieved by strategic planning of plants and sites, by good device design and by applying primary techniques which reduce noise at source or by means of secondary techniques which reduce noise propagation where needed.

The most effective combination of techniques has to be identified individually for each plant or production site and does not necessarily include noise reduction techniques at the source with the highest emission, but with the highest impact value. Therefore, a combination of techniques used at noise sources close to the affected areas may be the most efficient way to reduce environmental noise.

The noise emissions in LCPs are usually technically manageable. Since increased distance from the source lowers noise, planning of land used both on a community level and within a specific industrial site is perhaps the best preventive measure to avoid noise problems. Inside the building, the same principle applies, i.e. the layout design should separate the working areas from noisy equipment.

Some common noise control techniques are:

- careful orientation and location of noise-emitting machinery, also taking into consideration the change of frequency of the sound;
- enclosure of noisy plant components (e.g. gas turbines, steam turbines and generators) in sound-absorbing structures;
- use of anti-vibration supports and interconnections for equipment;
- ventilation of enclosures with low-noise fans;
- addition of cladding to the support structure of noisy equipment;
- fitting of high-level flue-gas silencers;
- location of boiler feed pumps in enclosures;
- building of a pump house around the pumps for circulating the cooling water;
- operation of low-noise fans in the cooling towers (it should be noted that the noise emissions from once-through cooling water systems are less than from cooling towers);
- use of embankments or other noise barriers to screen the source of the noise.

Requirements stipulated by the authorities can encourage manufacturers to reduce the noise generated by equipment and thus to create a competitive advantage.

In recent years, interest in noise has increased and has led to a series of noise regulations. The objectives of such regulations are to ensure appropriate and sufficient protection for the environment from plant noise and to provide planning security for the planners and future operators of new plants with respect to compliance with the regulations. To achieve these objectives, it may be practical to specify values, i.e. at receiver points (noise-sensitive receptors, NSRs) in the neighbourhood and, at these points, sound levels for the noise emitted by the plant. Based on these target values and the noise-relevant plant characteristics, a noise study may be an indispensable part of the permitting phase. In such a study, an acoustic planning concept should be worked out and sound propagation calculations applied to ensure and demonstrate

that the target values can be complied with. Periodically (e.g. three times per year), the operator should assess whether any new noise sources exist.

3.1.13 Cooling techniques

The operation of large combustion plants is governed by ‘Carnot’s principle’. The heat source, i.e. the boiler, provides the energy required for the water vaporisation. The cold source, i.e. the condenser, condenses the steam coming out of the low-pressure turbine. The condenser and the cooling system are, therefore, the key parts of the facility. Regardless of the mode of cooling adopted, it is in fact one of the main interfaces between the combustion plant and the surrounding environment. The efficiency and availability of a power plant depend, to a great extent, on the integrity and cleanness of the condenser and the cooling system.

A variety of applications can be found, all aimed at meeting process, site, environmental and economic requirements. The environmental impact of cooling techniques used in large combustion plants is described in the BREF on industrial cooling systems.

Each cooling system is designed to provide cold water suitable for maintaining turbine operation at the optimum design point. But the cooling systems are not equivalent in their capacity to take into account the daily and seasonal variations in source water and meteorological conditions. Greater sensitivity of dry cooling systems to ambient conditions is to be noted, entailing a greater impact on plant operating efficiency. [121, Eurelectric 2012]

Most plants in the 2012 data collection report the use of a direct once-through system for cooling, where the coolant (i.e. water) is pumped from a source (e.g. river, sea, lake), it passes through a heat exchanger (where the heat is transferred from the process to the coolant through a partition wall) and finally it is discharged back to the receiving water. In many of those cases the coolant passes through a cooling tower before it is discharged back to the receiving water. A number of plants also report the use of an indirect once-through system. In this case, the primary coolant (i.e. water) is pumped from a source, it passes through a heat exchanger (the heat is transferred in the heat exchanger from the secondary cooling circuit to the primary coolant through a partition wall) and finally it is discharged back to the receiving water. In the secondary circuit, there is another heat exchanger where the heat is transferred from the process to the secondary coolant through a partition wall. In some cases the primary coolant passes through a cooling tower before it is discharged back to the receiving water. Open recirculating wet cooling systems are also reported in the 2012 data collection, as well as closed circuit systems. Few examples of hybrid (wet/dry) cooling systems are reported. [3, LCP TWG 2012]

3.1.14 Emission monitoring and reporting

This section is intended to give general information on the monitoring and reporting of emissions from combustion plants. The methods and instruments used for the monitoring of emissions are the relevant national or international methods (e.g. European Committee for Standardisation (CEN); ISO; VDI Richtlinien; Netherlands Emission Regulations; UK Guidance Notes: British Standards, etc.). For more detailed information on general monitoring issues, reference is made to the JRC Reference Report on Monitoring of emissions to air and water from IED installations.

3.1.14.1 Emission components

The most common emission components to air that are measured at LCPs or that are calculated using emission factors and other methods are:

- diffuse dust emissions, e.g. from the unloading, storage (short- and long-term) and handling of fuel;
- dust as stack emissions (including PM_{10} and $PM_{2.5}$);
- sulphur oxides (SO_x);
- nitrogen oxides (NO_x);
- nitrous oxide (N_2O);
- metals;
- carbon monoxide (CO);
- carbon dioxide (CO_2);
- hydrogen fluoride (HF);
- hydrogen chloride (HCl);
- ammonia (NH_3);
- hydrocarbons (as unburnt hydrocarbons, UHC);
- volatile organic compounds (VOCs);
- dioxins and/or POPs.

For water pollution, the following parameters can be monitored:

- suspended solids;
- metals;
- salts (chloride and sulphate);
- organic halides;
- biocides;
- phosphate;
- altered pH values.

The pH value and the other components are reported as a whole or partly in the fuel-specific chapters, depending on the fuel used and the availability of data. Methods of analysis are given in relevant national and international guidelines on monitoring and analysis.

3.1.14.2 Reference conditions and parameters

For emissions to air, the following flue-gas parameters are determined to convert the emission concentrations obtained to standard conditions, i.e. 273 K, 101.3 kPa, reference oxygen level and dry gas:

- the volumetric flue-gas flow (in order to calculate the concentration and emission mass flow);
- the flue-gas temperature;
- the water vapour content of the flue-gas;
- the static pressure in the flue-gas duct;
- the atmospheric pressure;

- the monitoring period/averaging period;
- the oxygen content.

In addition to the above-mentioned parameters, for good operation of the combustion plant and the flue-gas cleaning system, additional measurements of certain parameters (such as voltage and electricity (electrostatic precipitators), pressure drop (bag filters), pH of scrubbing fluid (scrubbers)) and pollutant concentrations at various sites within the flue-gas ducts may be necessary.

3.1.14.3 Sampling points

The sampling points meet the requirements of EN standards (i.e. EN 15259).

The sampling points need to be situated in a section of the flue-gas duct where representative and homogeneous flow conditions and concentrations of pollutants are expected.

The measurement sites allow access to the sampling plane for typical sampling equipment consisting of structures and technical equipment, for example working platforms, measurement ports and energy supply.

3.1.14.4 Monitoring of emissions

The monitoring of emissions is carried out to determine the substances in the flue-gas or waste water in order to check the compliance with the emission limit values of the permit, to report to the authorities (e.g. to the E-PRTR), to control the combustion process or abatement system, and/or to predict the environmental impact of the plant or process.

Monitoring analysis during normal operating conditions and OTNOC can be carried out by direct measurements (i.e. direct source testing) or by using surrogate parameters. Direct measurements can be continuous or periodic.

The minimum monitoring frequency depends on the type of pollutant, the fuel combusted, the plant size, the monitoring practices and the implemented abatement techniques.

3.1.14.4.1 Continuous monitoring

In general, continuous direct measurements are the most accurate and preferred method of monitoring emissions. Continuous emission monitoring of a number of components in gases or in waste water is possible, and, in several cases, accurate concentrations (mg/Nm^3 , ppm or mg/l) can be reported continuously or as mean values over agreed time periods (half-hourly, daily, etc.). However, conditions for this are that the existing infrastructure is good and trained personnel are available to operate the equipment (for calibration procedures, etc.). Prime mover differences such as over/underpressures in the flue-gas, pressure fluctuations, flue-gas temperature, etc. are to be taken into account in the choice of the equipment. In these cases, discontinuous measurements, e.g. annual/six-monthly measurements, where practical, are preferred.

Continuous monitoring and associated software allows the reporting of concentration values for the main released pollutants in the required averaged standard (from half an hour to a month).

[10, METSO 2012]

In EN 14181:2014, a quality assurance system, based on different Quality Assurance Levels (QAL1, QAL2, QAL3) for automated measuring systems (AMSs) is defined for emissions to

air. This standard is applicable to AMSs installed at emission sources for the determination of the flue-gas components and other flue-gas parameters. In EN 15267 Parts 1 to 3, the Quality Assurance Level QAL1 and the procedures for achieving the required certifications are defined, and these are applied before the AMS is installed at the emission source.

The EN ISO 5667-1:2006 standard gives some guidance on measurement and sampling for emissions to water, distinguishing between continuous and periodic measurements, between continuous and periodic sampling, and between composite and spot samples.

3.1.14.4.2 Periodic monitoring

Periodic measurements are the determination of a measurand at specified time intervals in the case of emissions to air. For these measurements, the flue-gas sample is extracted from the channelled emission and the pollutant is analysed instantly with portable measuring systems or afterwards in the laboratory.

The number of consecutive individual measurements in one measurement series should be specified in accordance with the measurement objective and in relation to the stability of the emission. When measuring a stable emission, best practice is to take a minimum of three samples consecutively in one measurement series.

The timing and duration of the emission measurement should be specified in the measurement plan in accordance with the measurement objective. The most common sampling duration is 30 minutes, but 60 minutes is applied as well, depending on the pollutant and the emission pattern of the process.

Related to emissions to water, composite samples and spot samples can be distinguished for periodic measurements. Composite samples are the most commonly used samples. They are obtained by mixing a proportional amount of periodically (or continuously) taken samples. Composite samples provide average compositional data. Consequently, before combining samples, it is verified that such data are desired and that the parameter(s) of interest do(es) not vary significantly during the sampling period. Spot samples are discrete samples taken at random time intervals. They are generally not related to the waste water volume discharged.

3.1.14.4.3 Indirect monitoring using surrogate parameters

Surrogate parameters are measurable or calculable parameters that can be used instead of the direct measurements of specific pollutant values. The use of surrogate parameters, either individually or in combination, may provide a sufficiently reliable picture of the nature and proportions of the emission.

Predictive Emissions Monitoring Systems (PEMS) are systems used to determine the emissions concentration of a pollutant based on its relationship with a number of characteristic continuously monitored process parameters (e.g. fuel gas consumption, air to fuel ratio) and fuel or feed quality data (e.g. the sulphur content) of an emission source. PEMS are used with some gas turbines to determine NO_x/CO/CO₂ releases. These systems are computer-based and rely on the recording of a number of process variables, such as fuel flow, combustion temperature, ambient pressure/temperature, etc. The parameters are then processed via an algorithm specific to each installation to derive relevant pollutant concentrations in releases to air and mass releases. The systems are usually calibrated by discontinuous monitoring once a year and have been demonstrated to be very accurate. There are also proprietary packages, with some packages commercially available.

Fuel analysis can be used to predict emissions of compounds such as SO₂ or CO₂ and elements such as metals and other pollutants based on the application of conservation laws, if the fuel

throughput is measured. The presence of certain elements such as sulphur and metals in the fuel can then be used to calculate their presence in the raw flue-gas streams [153, ESAA 1999]. Assuming complete conversion of sulphur, SO_2 emissions, for instance, from oil combustion, can be calculated based on the content of sulphur present in the oil.

3.1.15 Influence of load factors and modes on environmental performances

Flexible operation of power plants can affect the emissions of NO_x and CO and the energy efficiency compared with stable operation, as is illustrated in

The load factor is defined as the ratio between the fuel thermal input at any time and the rated thermal input.

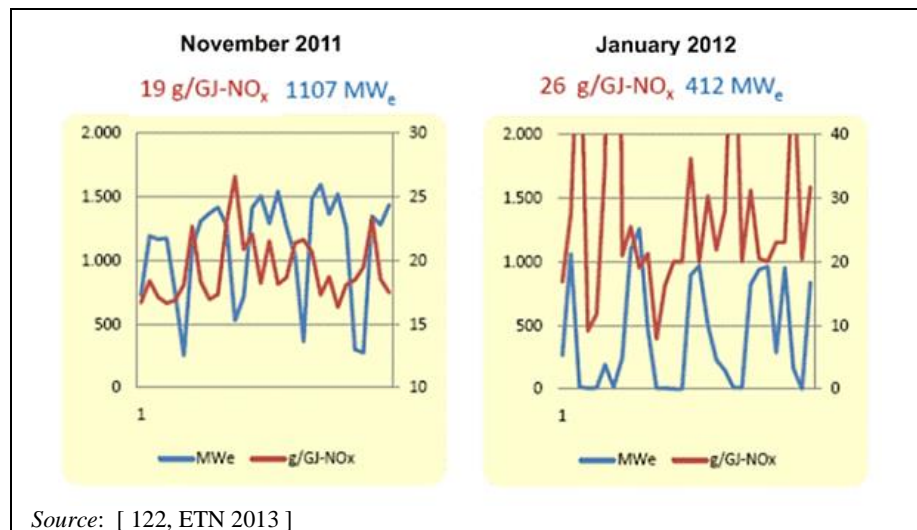

Figure 3.10: Impact of load factor variation on NO_x emissions at a GDF Suez natural gas combined-cycle plant, including five units of 385 MW_e

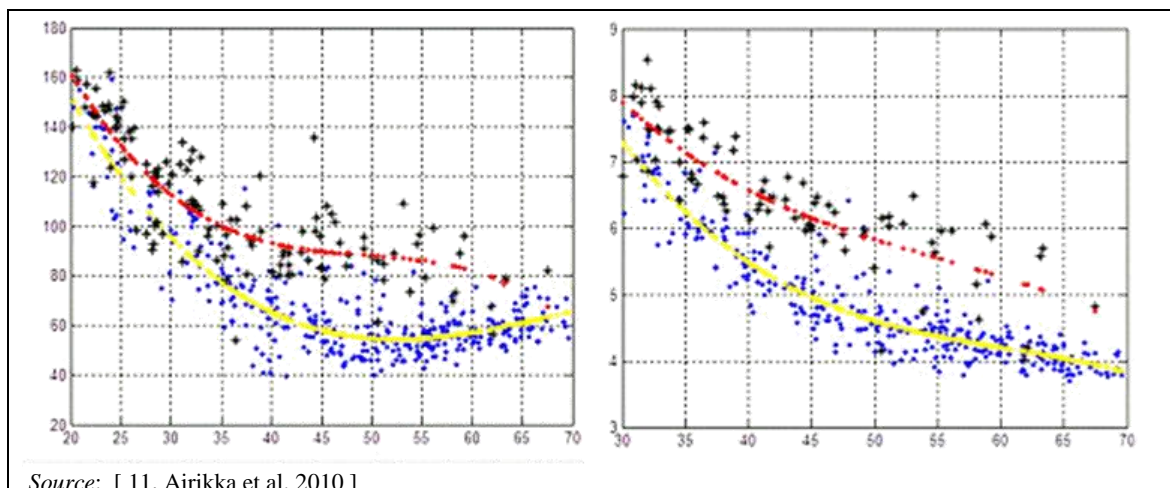

Figure 3.11: Example of NO_x (mg/Nm^3 , left) and O_2 (% , right) (y axis) for different load factors (x axis) at a BFB boiler in Sweden

Variation of energy efficiency with the unit load factor

The energy efficiency of a plant is at a maximum when running continuously and steadily at the maximum rated output. This state defines the 'baseload reference' level of efficiency. The effect of reducing the plant output is a significant reduction in the net energy efficiency. The plant

energy efficiency depends on both the output load and the ambient conditions. Typically, the energy efficiency decrease between baseload and minimum load is about 4 to 13 percentage points. Plant energy efficiency is therefore somewhat dependent on the mode of operation.

Variation of energy efficiency with the number of operating hours (load mode)

In addition to partial loading, the operating pattern can also have a significant effect on energy efficiency, in particular the number of start-ups and shutdowns. A lower level of operation during a year will result in a greater number of start-ups, because the plant is being run on a two-shift pattern with daily start-ups and shutdowns, rather than continuously overnight. Start-ups reduce energy efficiency; due both to the need to reheat the unit back to the operating temperature and to the lower energy efficiency at lower loads while the output is progressively increased. Shutdowns have a similar effect. Variations in ambient conditions and general operation give rise to in-year baseload efficiency variations of typically about two percentage points.

Influence of load modes and load factors on the environmental performance of combustion plants

For the purpose of this BREF, data related to the number of hours operated yearly (load mode) and to the way the plant is operated compared with its full capacity (load factor) have been collected and assessed together with the environmental parameters (emissions, consumption, efficiencies) and have been considered when setting the BAT-AELs. [12, UK-TWG 2012], Plant 506 of [3, LCP TWG 2012].

3.1.16 Other than normal operating conditions (OTNOC)

To reduce emissions during other than normal operating conditions (OTNOC), a management plan may be set up and implemented as part of the environmental management system, along with the implementation of traceable concrete measures commensurate with the type of possible OTNOC. These measures include:

- appropriate design of systems considered to cause OTNOC and that may have an impact on emissions (e.g. low load design concepts for reducing the minimum start-up and shutdown loads for stable generation in gas turbines);
- drawing up of specific preventive maintenance plans for these relevant systems, where needed;
- review and recording of emissions caused by OTNOC;
- implementation of corrective actions to return to normal operating conditions (NOC);
- periodic assessment of overall emissions during OTNOC (e.g. frequency of events, duration, emissions quantification/estimation) and implementation of corrective actions if necessary.

Monitoring of emissions during OTNOC is important as high pollutant emissions may occur during these periods. Some countries include emissions monitoring provisions in environmental permits.

There may be cases in which alternative monitoring is more precise than direct emissions measurement, e.g. monitoring based on surrogate parameters if the monitoring device is not well calibrated in the range of emissions. Using emissions arising from a typical OTNOC as the basis for assessing the emissions of each OTNOC is also a possibility as long as these OTNOC can be linked by quantifiable parameter(s).

Start-ups and shutdowns

Commission Implementing Decision 2012/249/EU refers to the determination of start-up and shutdown periods for combustion plants for the purposes of the IED.

During start-ups and shutdowns, plant emission levels may vary significantly and it is therefore important to control these phases as much as possible, e.g. by limiting their duration or using a less polluting fuel, hence limiting the amount of emissions. There are tools for monitoring and analysing the start-ups, whether the plant is started manually or automatically using a sequence, and the manufacturer start-up curves are taken into account at all times. Special automated solutions enable the tracking of start-ups, comparisons to manufacturer curves and comparisons of actual start-ups to each other. This helps the plant staff to find the best possible start-up practices. [13, METSO 2012]

Other OTNOC

It is important to identify other than normal operating conditions as they may affect the level of emissions or consumption of the combustion plant. The following situations are examples of conditions that may be considered OTNOC:

- periods related to malfunction or breakdown of the abatement techniques;
- testing periods (e.g. commissioning periods, periods after modifications to the combustion chamber, or testing periods of new/repared abatement techniques or of the combustion of a new fuel);
- periods corresponding to the use of emergency fuels for a very short period due to the lack of availability of normally used fuels (serious shortage or sudden interruption) or to disturbances in fuel feeding;
- periods of exceptional low-load operations due to unplanned malfunction of plant system(s);
- periods related to sudden major combustion failures;
- periods related to malfunction of the auxiliary or monitoring systems (e.g. malfunctioning of the analysis instrument or data transfer related to the process control);
- periods of calibration of monitoring systems requiring measurement points outside the range corresponding to normal operating conditions;
- extraordinary/unforeseeable variations in fuel quality whereby the installation/equipment performance cannot be guaranteed by the manufacturer (outside design specifications) and/or where there is a failure in the application of the fuel quality check procedures;
- in the case of bypass of control equipment or a process, when the bypass is unavoidable, e.g. to prevent loss of life or personal injury.

3.2 Techniques to consider in the determination of general BAT for the LCP sector

This section describes techniques (or combinations thereof), and associated monitoring, considered to have the potential for achieving a high level of environmental protection in the activities within the scope of this document. The techniques described will include both the technology used and the way in which the installations are designed, built, maintained, operated and decommissioned.

It covers environmental management systems, general process-integrated techniques and general end-of-pipe techniques. Waste prevention and management, including waste minimisation and recycling procedures, are also considered, as well as techniques that reduce the consumption of raw materials, water and energy by optimising use and reuse. The techniques described also cover measures used to prevent or to limit the environmental consequences of accidents and incidents, as well as site remediation measures. They also cover measures taken to prevent or reduce emissions under other than normal operating conditions (such as start-up and shutdown operations, leaks, malfunctions, momentary stoppages and the definitive cessation of operations).

Annex III to the Directive lists a number of criteria for determining BAT, and the information within this chapter addresses these considerations. As far as possible, the standard structure in Table 3.4 is used to outline the information on each technique, to enable a comparison of techniques and the assessment against the definition of BAT in the Directive.

This chapter does not necessarily provide an exhaustive list of techniques which could be applied in the sector. Other techniques may exist, or may be developed, which could be considered in the determination of BAT for an individual installation.

Table 3.4: Information for each technique described in this chapter

Headings within the sections
Description
Technical description
Achieved environmental benefits
Environmental performance and operational data
Cross-media effects
Technical considerations relevant to applicability
Economics
Driving force for implementation
Example plants
Reference literature

3.2.1 Environmental management systems

Description

A formal system to demonstrate compliance with environmental objectives.

Technical description

The Directive defines 'techniques' (under the definition of 'best available techniques') as 'both the technology used and the way in which the installation is designed, built, maintained, operated and decommissioned'.

In this respect, an environmental management system (EMS) is a technique allowing operators of installations to address environmental issues in a systematic and demonstrable way. EMSs are most effective and efficient where they form an inherent part of the overall management and operation of an installation.

An EMS focuses the attention of the operator on the environmental performance of the installation; in particular through the application of clear operating procedures for both normal and other than normal operating conditions, and by setting out the associated lines of responsibility.

All effective EMSs incorporate the concept of continuous improvement, meaning that environmental management is an ongoing process, not a project which eventually comes to an end. There are various process designs, but most EMSs are based on the plan-do-check-act cycle (which is widely used in other company management contexts). The cycle is an iterative dynamic model, where the completion of one cycle flows into the beginning of the next (see Figure 3.12).

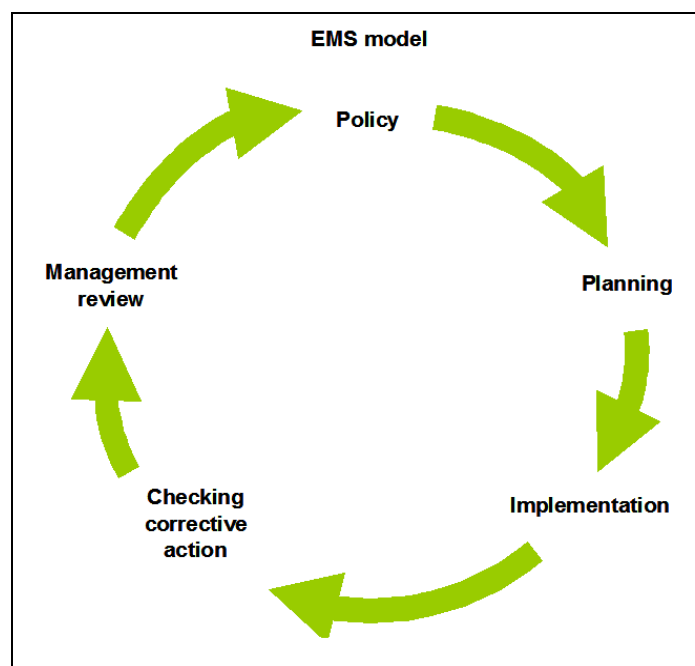

Figure 3.12: Continuous improvement in an EMS model

An EMS can take the form of a standardised or non-standardised ('customised') system. Implementation and adherence to an internationally accepted standardised system, such as EN ISO 14001:2015, can give higher credibility to the EMS especially when subjected to a properly performed external verification. EMAS provides additional credibility due to the interaction with the public through the environmental statement and the mechanism to ensure compliance with the applicable environmental legislation. However, non-standardised systems can, in principle, be equally effective provided that they are properly designed and implemented.

While both standardised systems (EN ISO 14001:2015 or EMAS) and non-standardised systems apply in principle to organisations, this document takes a narrower approach, not including all activities of an organisation, e.g. with regard to their products and services, due to the fact that the Directive only regulates installations/plants.

An EMS can contain the following components:

1. commitment of management, including senior management;
2. definition of an environmental policy that includes the continuous improvement of the installation by the management;
3. planning and establishing the necessary procedures, objectives and targets, in conjunction with financial planning and investment;
4. implementation of procedures paying particular attention to:
 - (a) structure and responsibility,
 - (b) recruitment, training, awareness and competence,
 - (c) communication,
 - (d) employee involvement,
 - (e) documentation,
 - (f) effective process control,
 - (g) planned regular maintenance programmes,
 - (h) emergency preparedness and response,
 - (i) safeguarding compliance with environmental legislation;
5. checking performance and taking corrective action paying particular attention to:
 - (a) monitoring and measurement (see also the Reference Report on the Monitoring of Emissions to Air and Water from IED installations - ROM),
 - (b) corrective and preventive action,
 - (c) maintenance of records,
 - (d) independent (where practicable) internal and external auditing in order to determine whether or not the EMS conforms to planned arrangements and has been properly implemented and maintained;
6. review of the EMS and its continuing suitability, adequacy and effectiveness by senior management;
7. preparation of a regular environmental statement;
8. validation by a certification body or an external EMS verifier;
9. following the development of cleaner technologies;
10. consideration for the environmental impacts from the eventual decommissioning of the installation at the stage of designing a new plant, and throughout its operating life including:
 - (a) avoiding underground structures,
 - (b) incorporating features that facilitate dismantling,
 - (c) choosing surface finishes that are easily decontaminated,
 - (d) using an equipment configuration that minimises trapped chemicals and facilitates drainage or cleaning,
 - (e) designing flexible, self-contained equipment that enables phased closure,
 - (f) using biodegradable and recyclable materials where possible;
11. application of sectoral benchmarking on a regular basis.

Specifically for this sector, it is also important to consider the following potential features of the EMS:

12. quality assurance/quality control programmes to ensure that the characteristics of all fuels are fully determined and controlled;
13. a management plan in order to reduce emissions to air and/or water during other than normal operating conditions, including start-up and shutdown periods.
14. a waste management plan to ensure that, in order of priority, waste is avoided, prepared for reuse, recycled or otherwise recovered;

15. a process quality optimisation system in order to identify and implement improvements to increase energy efficiency and fuel utilisation;
16. an environmental and safety management system to identify and plan to prevent and deal with uncontrolled and/or unplanned emissions to the environment, in particular:
 - (a) emissions to soil and groundwater from the handling and storage of fuels, additives, by-products and wastes,
 - (b) due to the risk of self-heating and/or self-ignition of fuel in the storage and handling activities;
17. a dust management plan to prevent or, where this is not practicable, to reduce diffuse emissions from loading, unloading, storage and/or handling of fuels, residues and additives;
18. a noise management plan where a noise nuisance at sensitive receptors is expected or sustained, including:
 - (a) a protocol for conducting noise monitoring at the plant boundary,
 - (b) a noise reduction programme,
 - (c) a protocol for response to noise incidents containing appropriate actions and timelines,
 - (d) a review of historic noise incidents, corrective actions and dissemination of noise incident knowledge to the affected parties;
19. for the combustion, gasification or co-incineration of malodorous substances, an odour management plan including:
 - (a) a protocol for conducting odour monitoring,
 - (b) where necessary, an odour elimination programme to identify and eliminate or reduce the odour emissions,
 - (c) a protocol to record odour incidents and the appropriate actions and timelines,
 - (d) a review of historic odour incidents, corrective actions and the dissemination to the affected parties.

Achieved environmental benefits

An EMS promotes and supports the continuous improvement of the environmental performance of the installation. If the installation already has a good overall environmental performance, an EMS helps the operator to maintain the high performance level.

Environmental performance and operational data

No information provided.

Cross-media effects

None reported. The systematic analysis of the initial environmental impacts and scope for improvements in the context of the EMS sets the basis for assessing the best solutions for all environmental media.

Technical considerations relevant to applicability

The components described above can typically be applied to all installations within the scope of this document. The scope (e.g. level of detail) and nature of the EMS (e.g. standardised or non-standardised) will be related to the nature, scale and complexity of the installation, and the range of environmental impacts it may have.

Economics

It is difficult to determine accurately the costs and economic benefits of introducing and maintaining a good EMS. There are also economic benefits that are the result of using an EMS and these vary widely from sector to sector.

External costs relating to verification of the system can be estimated from guidance issued by the International Accreditation Forum. [180, IAF 2010]

Driving force for implementation

The driving forces for the implementation of an EMS include:

- improved environmental performance;
- improved insight into the environmental aspects of the company which can be used to fulfil the environmental requirements of customers, regulatory authorities, banks, insurance companies or other stakeholders (e.g. people living or working in the vicinity of the installation);
- improved basis for decision-making;
- improved motivation of personnel (e.g. managers can have confidence that environmental impacts are controlled and employees can feel that they are working for an environmentally responsible company);
- additional opportunities for operational cost reduction and product quality improvement
- improved company image;
- reduced liability, insurance and non-compliance costs.

Example plants

EMSs are applied in a number of installations throughout the EU.

Reference literature

EMAS Regulation (EC) No 1221/2009. [171, EC 2009]

DG Environment EMAS website. [172, DG Environment 2010]

EN ISO 14001: 2015

ISO 14000 family of standards website. [168, CEN 2015]

3.2.2 Techniques to prevent and/or reduce channelled emissions to air

3.2.2.1 Techniques to prevent and/or reduce dust emissions

3.2.2.1.1 Electrostatic precipitators (ESPs)

Description

Electrostatic precipitators (ESPs) operate such that particles are charged and separated under the influence of an electrical field. Electrostatic precipitators are capable of operating over a wide range of conditions.

The abatement efficiency may depend on the number of fields, residence time (size), and upstream particle removal devices. They generally include between two and five fields. The most modern (high-performance) ESPs have up to seven fields.

Technical description

There are both wet and dry ESP types. Corrosion and abrasion resistance are built into both the wet and dry designs [173, Theodore and Buonicore 1992], [174, Soud 1993], [175, Soud 1995], [176, VDI 1998], [148, CIEMAT 2000]. A typical arrangement of an ESP is shown in Figure 3.13.

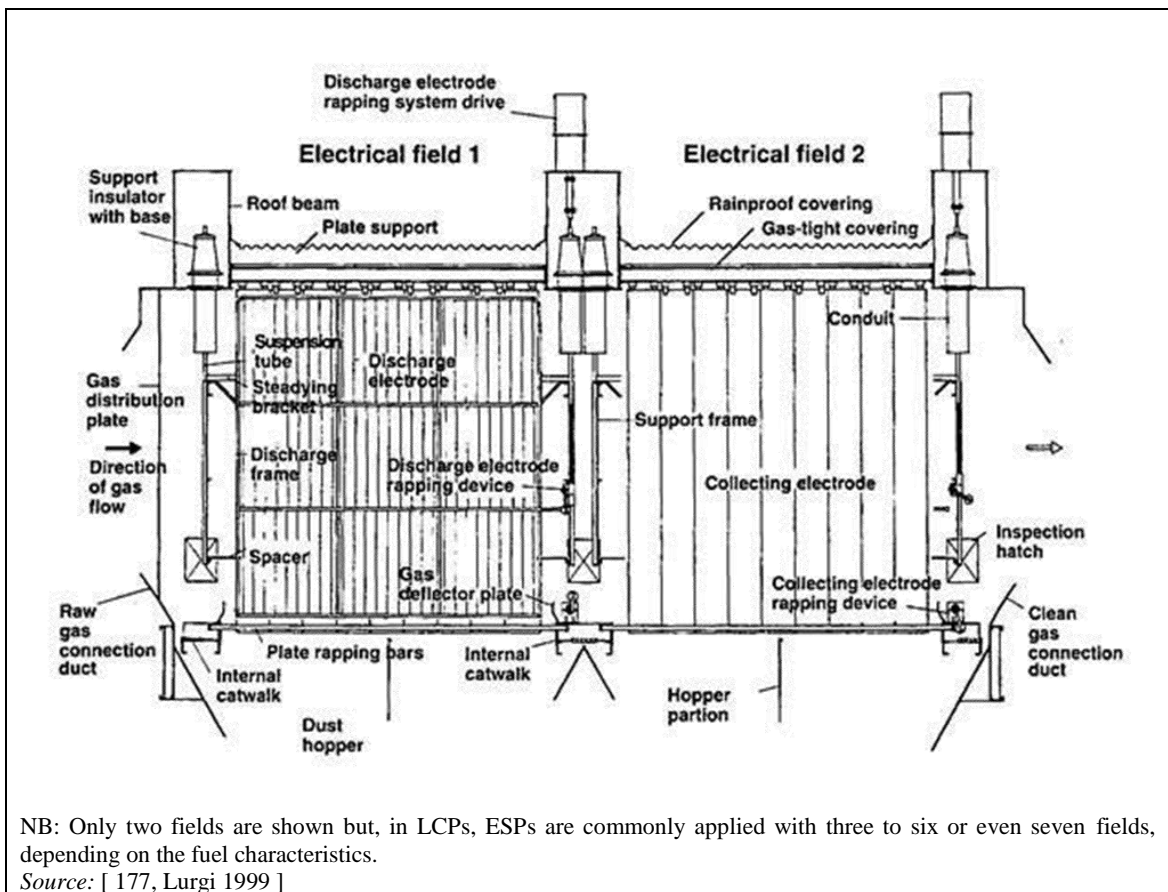

Figure 3.13: Typical schematic arrangement of an ESP

An ESP consists of a hopper-bottomed box containing rows of plates forming passages through which the flue-gas flows. Centrally located in each passage are emitting electrodes energised with high-voltage direct current, which is provided by a transformer/rectifier (T/R) set. The electrical field is applied across the electrodes by a small direct current at high voltage (60–120 kV). The voltage applied is high enough to ionise the gas molecules close to the electrodes, resulting in a visible corona. The flow of gas ions from the emitting electrodes across the gas passages to the grounded collecting plates constitutes what is called the corona current.

When passing through the flue-gas, the charged ions collide with, and attach themselves to, fly ash particles suspended in the gas. The electrical field forces the charged particles out of the gas stream towards the grounded plates, where they collect in a layer. The plates are periodically cleaned by a rapping system to release the layer into the ash hoppers as an agglomerated mass. In practice, an ESP is divided into a number of discrete zones (up to six zones are commonly used). In most cases, the ESP is located after the air heater or economiser and referred to as a cold-side installation. In special cases, it is located before the air heater to take advantage of the higher temperature. In this case, it is called a hot-side installation.

Particles are removed from the gas stream in four stages:

- through application of an electrical charge to the dust;
- through placement of the charged dust in an electrical field;
- by capture (agglomeration) of the dust onto the collecting electrode;
- by removal of the dust from the surface of the electrode.

Good rectifier design is used, which includes the use of separate rectifier sections for each field or portion of a field of the ESP. This allows the applied voltage to be varied in the inlet and outlet zones to take account of the reduced dust load towards the outlet and the fields to be operated at progressively higher voltages without sparking. Good design also involves the use of automatic control systems. They maintain the optimum high voltage (HV) applied to the electrodes in a particular zone without sparking. An automatic monitor is used to apply the maximum voltage without sparking and constantly varies the HV. Fixed HV power supplies are unlikely to provide optimal collection efficiencies.

The resistivity (the inverse of the conductivity) of the dust is particularly important. If it is too low, the particles reaching the collector electrode lose their charge easily and dust re-entrainment can occur. When the dust has too high a resistivity, an insulating layer is formed on the electrode, which hinders normal corona discharge and leads to a reduction of the collection efficiency (back corona effect). It is now common practice with highly resistive ashes (e.g. the ones coming generally from low-sulphur fuels) to condition the flue-gas to reduce the resistivity of the ash, e.g. by injecting SO_3 into the flue-gas upstream of the ESP to form sulphuric acid. This is efficiently absorbed onto the particles and thus reduces the ash surface resistivity. The presence of an SCR system upstream of the ESP may also change the flue-gas conditions by oxidising part of the SO_2 into SO_3 , leading to the same flue-gas conditioning effect as mentioned before.

The particle size distribution affects the particle migration velocity. For particles of $> 1 \mu\text{m}$, the migration velocity is inversely proportional to the particle diameter, becoming independent of particle size for particles of $< 1 \mu\text{m}$. In addition, a high load of fine particles can cause a substantial change in the electrical conditions in an ESP. Within the ESP, the dust in the flue-gas is charged in an ionic space charge cloud. The nature of the space charge changes with the particle size distribution and the flue-gas loading. The particulate space charge increases with the number of particles per cubic metre of flue-gas entering the ESP. An increase in fine particles and a relatively high particle migration velocity in the higher flue-gas load can result in an increase in the space charge, and can subsequently cause an electrical short circuit. The corona current at the inlet field can be suppressed by the increased space charge. A much higher space charge can result in the corona current being suppressed throughout the ESP.

Rapping, used to dislodge the fly ash (dust cake) layer off the collection electrode into hoppers, may also cause re-entrainment. Particles are separated from the fly ash layer and re-entrained into the flue-gas. Re-entrainment can reduce the efficiency significantly. In effect, the ESP efficiency strongly depends on the unit size. An increase in efficiency incurs higher costs.

A moderate sulphur content in the flue-gas decreases the resistivity of particles and enables better particle reduction. However, uneven gas distribution in the precipitator may lead to there being cooler parts inside the device. Also, the higher the sulphur content of the fuel, the higher the possible dew point. If these two conditions occur simultaneously, i.e. an uneven temperature distribution and a higher dew point of sulphuric acid, there is a higher risk of material damage and hence a higher risk of the device breaking down.

Problems may also occur while burning fuels which form volatiles, as the volatiles can coat the particles and hamper their effective precipitation. This is possible with low calorific value fuels, and when the boiler process is unstable.

Wet electrostatic precipitators (WESPs) operate on the same principles as ESPs. In this case, the collected dust is removed from the collector plates by flushing with a suitable liquid, usually water, either intermittently or by continuous spray irrigation. This offers advantages for certain dusts that adhere to conventional plates or when other components in the gas stream interfere with the operation, for example in the case of a cool, damp gas.

Achieved environmental benefits

Reduction of dust, aerosol and metal emissions to air.

Environmental performance and operational data

ESPs are used extensively in large combustion plants and are capable of operating over a wide range of temperatures, pressures and dust burden conditions.

The performance of an ESP follows the Deutsch equation, which relates efficiency to the total surface area of the collecting electrodes, the volumetric flow rate of the gases and the migration velocity of the particles. Furthermore, geometric considerations (such as gas velocity, height over length ratio) also contribute to effective removal of dust. Therefore, for a given dust, maximising the surface area of the collecting electrodes is very important, hence current practice is to use wide electrode spacing. This practice relies, in turn, on good rectifier design and control. Another way of increasing the dust removal efficiency is to increase the electrode spacing. For this, T/R sets with higher voltages are needed.

Flue-gas flow distribution affects the overall performance of electrostatic precipitators. A uniform flue-gas velocity distribution is desirable throughout the entire cross section since it ensures the maximum collection efficiency of the unit. To achieve the best performance from a precipitator, the gas flow through the units is optimised to give a uniform flow to prevent flue-gas bypassing the electrical field. Correct design of inlet ducting and the use of flow distribution devices within the inlet mouthpiece can help a uniform flow to be achieved at the precipitator inlet.

It should also be noted that the free CaO content in the ash has an adverse effect on the ESP's particulate capture performance for resistivity reasons.

Table 3.5: General performance of an ESP

Technique	Removal efficiency (%)				Operating temperature	Configuration
	< 1 μm	2 μm	5 μm	> 10 μm		
Electrostatic precipitator (ESP)	> 96.5	> 98.3	> 99.95	> 99.95	80–220 °C	Cold ESP
					300–450 °C	Hot ESP
NB: The ESP has a very high efficiency, even for smaller particles. It can handle very large flue-gas volumes with low pressure drops. Low operating costs, except at very high removal rates. It can operate at any positive pressure. It is not very flexible, once installed, to changing operating conditions. It might not work on particulates with a very high electrical resistivity. The pressure drop is < 5 mbar. <i>Source: [178, ERM 1996]</i>						

Cross-media effects

Residue (fly ash) or liquid effluent (only in the case of wet ESPs) is produced which may require further treatment.

Additional electricity is consumed. In an example HFO-fired boiler of 415 MW_{th}, the consumption was about 0.32 % of the gross electric energy production (Plant 260). Other reported data show an installed related electrical capacity of about 0.1–0.15 % of the total rated thermal input (Plants 42, 127-2, 128-4).

The high voltage of an ESP can introduce a new hazard.

For some plants, ammonia may be injected to improve the ESP's performance. In these cases, ammonia emissions result from ammonia slip through the ESP.

Technical considerations relevant to applicability

ESPs may not be applicable for some particulates with high electrical resistivity.

The applicability of dry ESPs to treat flue-gases from units that combust liquid fuel may be limited due to a number of factors, including:

- the very low particle resistivity;
- the type of particles (e.g. high cenosphere content);
- the unfavourable flue-gas composition.

However, several example plants (175, 225, 258 to 263, 454, 472) combusting liquid fuels and fitted with ESPs achieve levels of dust emissions to air below 10 mg/Nm³ as a yearly average.

Economics

The cost of electrostatic precipitators includes costs due to electricity consumption, maintenance expenses (very dependent on the boiler process and fuel properties) and the transfer of the precipitated ash, but generally they are cost-effective devices for reducing dust emissions.

The initial investment costs may be higher or lower, depending on the applied fuel, than for other available techniques such as bag filters. However, operational costs are lower than the corresponding costs of the other techniques, and the use of modern control systems reduces these expenses even more. Operational costs can vary widely, depending on the different properties of fly ashes. Maintenance costs are normally very reasonable when processing ordinary fly ash. These devices are competitive at power plants which have a wide range of power equipment and a variety of boiler processes.

The UK has established indicative capital costs for ESPs of GBP 25/kW_e (1999 prices) and indicative operating costs of GBP 0.0003/kW_e (1999 prices) across all capacity ranges. [[120](#), [EEB 2013](#)]

The ESP has generally been the preferred economic solution, especially for larger plants. However, nowadays more and more bag filters are being installed, as they are considered a better economic solution for taking into consideration fuel flexibility issues and performance requirements.

Driving force for implementation

The legislative demands for reduced emissions of fine particulate matter have led to various research projects aimed at improving the efficiency of this technology.

Example plants

About 145 of the plants that submitted a questionnaire in 2012 for the review of this BREF are fitted with a dry ESP.

See each fuel section for further details.

Plant 139 uses an ESP with SO₃ conditioning.

Reference literature

No information provided.

3.2.2.1.2 Bag filters

Description

Bag or fabric filters are constructed from porous woven or felted fabric through which gases flow to remove dust. The use of a bag filter requires the selection of a fabric material suitable for the characteristics of the flue-gas and the maximum operating temperature.

Technical description

Fabric filtration is a method to remove particles (especially fly ash) from the flue-gas of industrial combustion plants. In addition to collecting fly ash, there have been a number of applications where bag filters have been used together with the injection of slurried or powdered sulphur dioxide absorbent (such as lime or sodium bicarbonate) to simultaneously control both sulphur dioxide and fly ash emissions.

A bag filter unit consists of one or more isolated compartments containing rows of bag filter bags or tubes. Dust-laden gas passes up (usually) along the surface of the bags then radially through the fabric. Particles are retained on the upstream face of the bags, while the now cleaned gas stream is vented to the atmosphere. The filter is operated cyclically, alternating between relatively long periods of filtering and short periods of cleaning. During cleaning, dust that has accumulated on the bags is removed from the fabric surface and deposited in a hopper for subsequent disposal. The major operating feature of bag filters that distinguishes them from other gas filters is the opportunity to check the filtering surface periodically when cleaning.

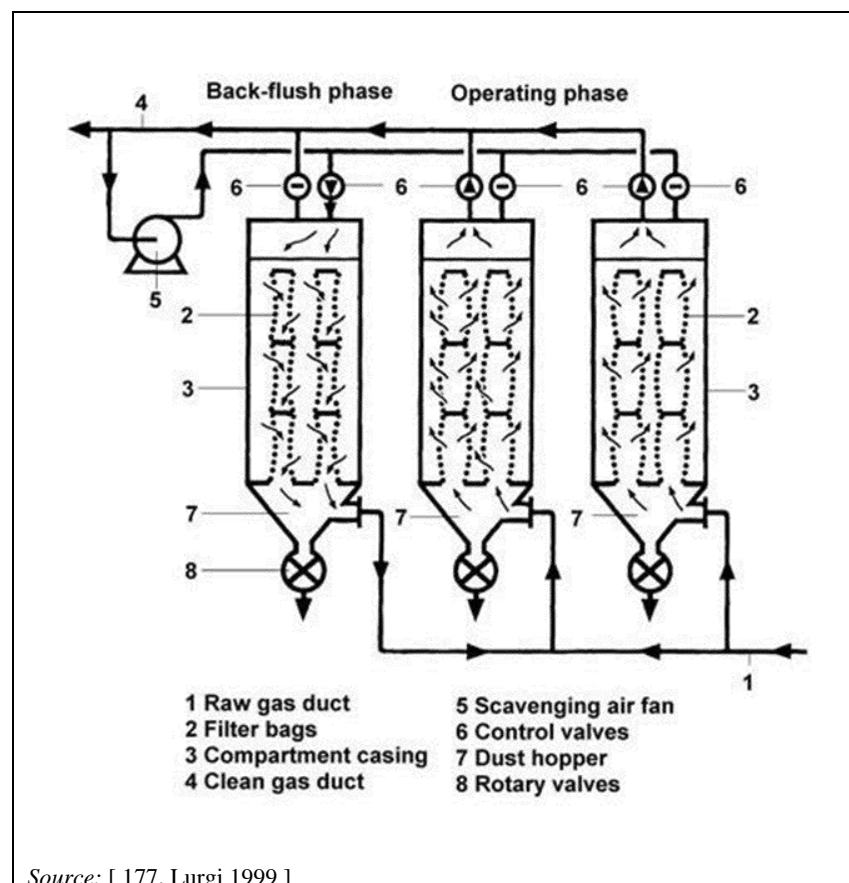

Figure 3.14: General arrangement of a bag filter (with one compartment in the cleaning cycle)

Regular dust removal from the fabric is important in order to maintain an effective extraction efficiency, but it also influences the operating life of the fabric. Bag filters are normally classified according to the method by which the filter media are cleaned. The most common cleaning method consists of compressed air pulsing. Other methods include reverse airflow,

mechanical shaking/deflating and vibration. Acoustic horns are also used for the cleaning of bags. The normal cleaning mechanisms do not result in the fabric returning to pristine condition, but the particles deposited within the depth of the cloth help reduce the pore size between the fibres, resulting in high filtering efficiencies for submicron particles.

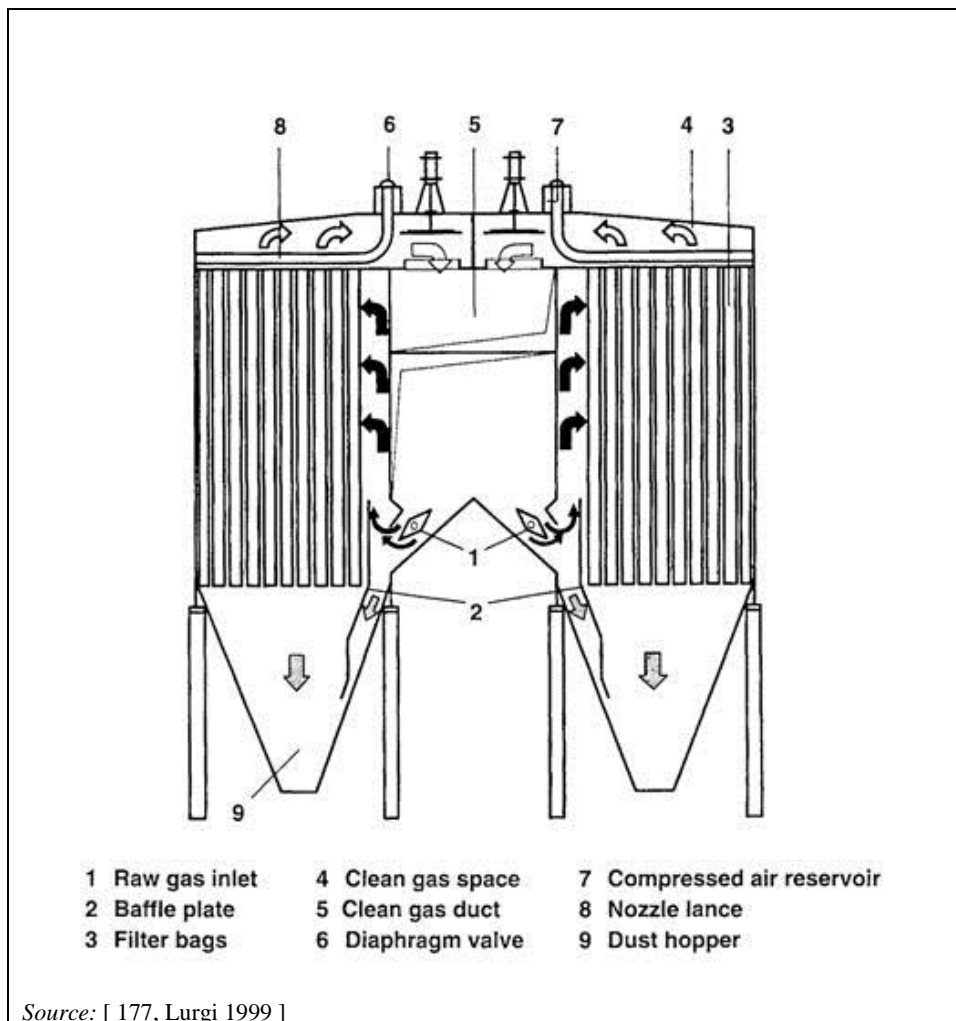

Figure 3.15: Low-pressure pulse-jet bag filter

Fabric selection takes into account the composition of the gases, the nature and particle size of the dust, the method of cleaning to be employed, the required efficiency and economics. The gas temperature also needs to be considered, together with the method of gas cooling, if any, and the resultant water vapour and acid dew point.

Wear of the filter bags results in a gradual but measurable reduction in performance. There may also be a risk of damage or catastrophic failure of several bags if corrosion occurs, when abrasive material is filtered or when there is the risk of fire. Simple online monitoring systems, such as pressure drop indicators or dust tell-tale devices, give only a rough indication of performance.

Triboelectric or optical devices are used to measure trends in the dust emissions from the bag filter to identify possible failure. They can also be used to detect dust peaks during a cleaning cycle. When these measurements are integrated with a zoned cleaning system, any zone that contains damaged bags can be identified and local repairs can then be made. [179, Robson 1998]

Synthetic filter cloths such as Gore-Tex[®] and Tefaire[®] (teflon/fibreglass) have enabled bag filters to be used in a wide range of applications and have led to extended filter lives. The performance of modern filter materials, even in high temperatures or abrasive conditions, has improved. Cloth manufacturers can recommend the materials that are most suitable for specific applications.

New methods to increase the air to cloth ratio and to reduce the pressure drop are continually being investigated. Flue-gas inlet and outlet modifications aim to improve the capture of the fly ash which is essential for optimal design and the high PM removal efficiency of the equipment.

Pulse-jet technology has become the preferred bag filter system as the primary particulate control device for utility and industrial boilers. Research is continuing to improve the understanding and hence performance of the system.

As there are many different filter materials on the market, the operator chooses the best one for their own needs. The filter material has to be selected with particular care to avoid possible problems being caused if the process parameters change.

Achieved environmental benefits

Reduction of dust, metal and aerosol emissions to air.

Environmental performance and operational data

Some fuels may cause clogging problems, which complicates the process operation. Clogging problems may occur, e.g. during start-ups, when oil is burnt. The filter material is usually quite sensitive to the temperature of the ash and flue-gases, so unburnt carbon and hot fly ash agglomerations may damage the filter material. Precoating of the filter fabric with available fly ash, lime material or other materials can reduce the risk of bag damage during the start-up of the filter. In applications where the ash has a high amount of unburnt matter, and there is a risk of sparks or glowing particles reaching the bag filter, a pre-collector upstream of the bag filter is recommended to reduce the risk of hopper fires and bag damage. Biomass-fired power plants are a typical example. [120, EEB 2013]

Also, cracks may form in the fabric material. These are difficult to detect during operation. These cracks increase the emissions of particles. If the baghouse is of a modular design and modules are isolated, then maintenance work may be possible without shutting down the process.

The bag filter operating temperature should be kept above the water and acid dew point of the flue-gas, in order to avoid chemical attack on the filter bags, dust-handling problems and corrosion. [120, EEB 2013]

Table 3.6: General performance of bag filters

Technique	Removal efficiency (%)				Other performance parameters	
	< 1 µm	2 µm	5 µm	> 10 µm	Parameter	Value
Bag filter	> 99.6	> 99.6	> 99.9	> 99.95	Operating temperature	150 °C (polyester) 260 °C (fibreglass)
					Energy consumption as % of electric capacity	0.2–3 %
					Pressure drop	5–20 (10 ² Pa)
					Residue	Fly ash
					Off-gas flow rate	< 1 100 000 m ³ /h
					Applicability	Solid and liquid fuels
					Market share	10 %
<p>NB: Market share of 10 % is mainly based on application in CFB combustion and SDA. Filtration velocities generally lie in the range 0.01 m/s to 0.04 m/s according to the application, the filter type and the cloth. Typical values used in power plant baghouses are 0.45–0.6 m/min for reverse-air, 0.75–0.9 m/min for shaker, and 0.9–1.2 m/min for pulse-jet applications. Bag life decreases as coal sulphur content increases and as the filtering velocity increases. Individual bags fail at an average annual rate of about 1 % of installed bags. The pressure drop increases as the particle size decreases for a given flue-gas throughput. Source: [178, ERM 1996]</p>						

A bag filter's efficiency is less influenced by particles' resistivity than an ESP's.

Cross-media effects

Residues are produced for which further treatment may be required. As for all other dry separation techniques, a reduction of the environmental impact is best achieved if a useful outlet is found for the collected solid dust material. Dust collection is essentially a shift from an air emissions issue to a waste issue. Depending on its source, the separated dust can be contaminated, e.g. dust originating from incineration might contain dioxins and/or metals and

their oxides. This type of dust might be classified as hazardous waste that should be disposed of accordingly. Bag filter material life is limited and creates another waste to dispose of.

Additional electricity is consumed (fans), up to double the amount needed when using an ESP.

Technical considerations relevant to applicability

Bag filters are applicable for solid-fuel-fired power plants (coal, lignite, pet coke, biomass, peat) of all sizes and combustion techniques, with and without sorbent injection upstream of the filter. They are also applicable for oil-, diesel-, oil residues- and Orimulsion-fired boilers provided that a sorbent (e.g. $\text{Ca}(\text{OH})_2$, NaHCO_3) is injected upstream of the filter. The sorbent dilutes the potentially sticky ash/soot from oil firing which might otherwise cause a high pressure drop over the bags.

Bag filters may be less effective in applications with flue-gas temperatures over 240 °C. Depending on the flow rate design parameters, they can reach significant volumes and require considerable space.

Bag filters are well adapted for processes likely to deliver variable flue-gas flows and dust concentrations. The high ratio type of filter (where the dust is collected on the outside of the bag) is particularly suited to FBC boilers, as its ability to perform well for varying ash compositions is suited to the inherent fuel flexibility of this type of boiler. The high ratio design is also particularly suited to use with an ESP that does not meet new standards, and where an extension of the ESP is difficult or not cost-effective. In these instances, the filter bags and associated bag-cleaning devices can often be installed in the precipitator casing, keeping investment to a minimum.

Bag filters are useful for collecting particulate matter with electrical resistivities either too low or too high for ESPs. [181, CEFIC 2013] [120, EEB 2013].

Economics

UK indicative capital costs (1999 prices) are GBP 10/kWe for bag filters. The operating costs (1999 prices) are GBP 0.0011/kWe. [120, EEB 2013]

Although capital costs of bag filters are quite low, maintenance costs are high, as the filter material has to be changed every two to five years. The minimum expense of the filter change is approximately 10 % of the investment cost. Precipitated material is easy to recycle, and, for example, unreacted sorbent can be returned to the process and has some economic value.

Driving force for implementation

Legislation is the main driving force. However, for those plants where the separated ash can be sold, economics is also a driver. Another is the possibility to burn a wide range of fuels/wastes.

Example plants

More than 40 plants that submitted a questionnaire in 2012 for the review of this BREF are fitted with a bag filter.

See each fuel section for further details.

Reference literature

No information provided.

3.2.2.1.3 Centrifugal precipitation (cyclones)

Description

Dust control system based on centrifugal force, whereby particles are separated from the carrier gas.

Technical description

This type of dust control system utilises centrifugal forces and can process all types of flue-gases, in dry conditions.

A mechanical separator is composed of a set of cyclones (e.g. an array of 31 x 24 cyclones, each with an individual diameter of about 240 mm, to treat 700 000 m³/h of flue-gases at 130 °C) assembled in one or several enclosures. The gases to be purified are shared between the cyclones via a suitably designed chamber. The centrifuged dust agglomerates at the periphery of the cyclones and is driven towards the bottom of the apparatus, where it falls into a hopper. In each cyclone, the purified gas escapes towards the top via a central tube, is collected in an outlet chamber and then flows out via the transport ducts.

Achieved environmental benefits

Reduction of dust emissions.

Environmental performance and operational data

Mechanical separators do not trap the fine dust. Thus, their efficiency is naturally limited to between 30 % and 90 %.

With boilers which burn lump coal on mechanical grates, cyclone technology is still in use because the quantity of fly ash is relatively small (20 % of coal ash compared with 80 % for pulverised fuel firing). Capture for the size range 5–10 microns is at or near 100 %. Capture does occur at smaller sizes, down to 1 micron, but at a reduced capture efficiency. Cyclone blowdown technology assists cyclones to achieve a higher efficiency, particularly cyclones serving LCPs where many small cyclone cells operate in parallel.

Cyclones perform more efficiently with higher pollutant loads, provided that the device does not become choked. Higher pollutant loads are generally associated with higher flow designs.

The collection efficiency of cyclones varies as a function of particle size and cyclone design.

The collection efficiency decreases with:

- increasing gas viscosity;
- increasing gas density;
- increasing the duct area of the gas inlet duct area;
- leakage of air into the dust outlet.

Table 3.7: General performance of dust cleaning devices

Technique	Removal efficiency (%)				Remarks
	< 1 µm	2 µm	5 µm	> 10 µm	
Cyclone	30–90 %. The smallest diameter of the dust trapped is 5–10 µm				Limited performance, so can therefore only be used with other techniques for dust control

Cross-media effects

Dust is emitted as a residue and has to be disposed of, if it cannot be reused or recycled. The amount depends on the dust load of the flue-gas. Depending on its source, the separated dust can be contaminated with toxic and/or hazardous substances.

The operation of cyclones is a source of significant noise.

Another cross-media effect is the requirement for waste water management in the case of use of hydraulic ash handling systems.

Technical considerations relevant to applicability

The performance characteristics limit its use to small or medium-sized installations, and only as a pre-collection technique when combined with other means for dust control.

Economics

Mechanical separators have the lowest investment cost of all the dust extraction equipment. As this technique is not able to act alone as a fly ash control measure, the combined control technique will also have to be considered when calculating the investment costs. Operating costs include the energy necessary for the pneumatic or hydraulic removal of the collected ash and electric power to compensate the flue-gas pressure loss of the equipment. Maintenance costs are reputedly low given the sturdiness of all of the components. The lifetime can be limited due to the high erosion risk. [123, Eurelectric 2001]

Driving force for implementation

No information provided.

Example plants

No information provided.

Reference literature

No information provided.

3.2.2.1.4 Wet scrubbers**Description**

Wet scrubbers comprise a group of particulate control devices which utilise a liquid to collect flue-gas particulate matter. The most common ones are venturi and moving-bed scrubbers.

Technical description

The venturi scrubber is probably the most common wet scrubber. In venturi scrubbers, the scrubbing liquid is introduced uniformly at the top of the converging section of the venturi as shown in Figure 3.16. The dust-laden flue-gas and the scrubbing liquid enter the venturi throat, in which atomisation of the scrubbing liquid takes place due to the velocity of the flue-gas alone.

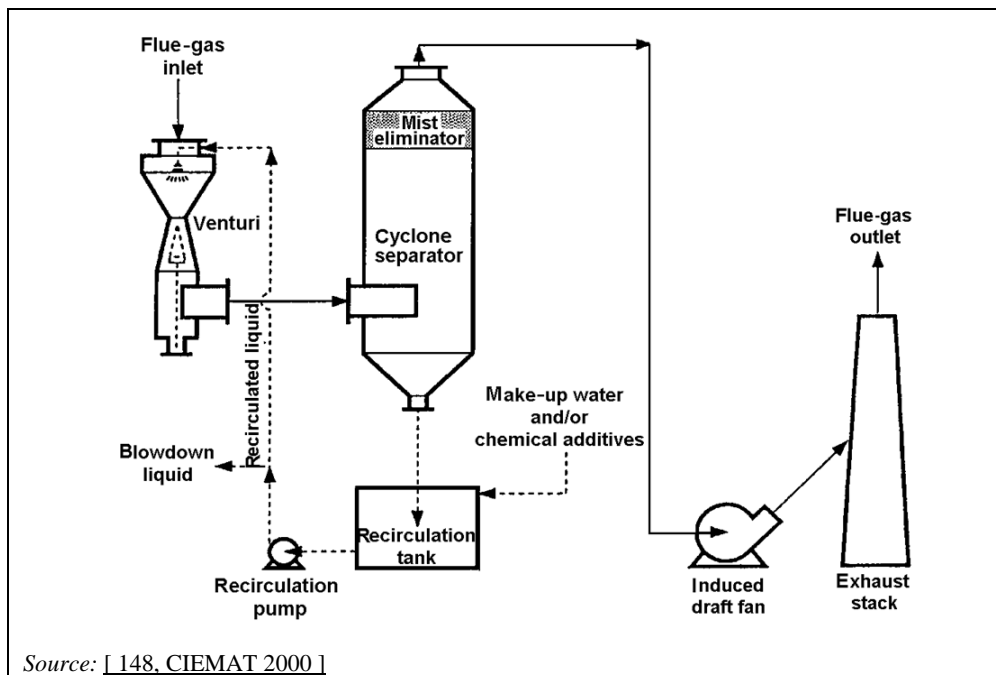

Figure 3.16: Typical flow diagram of a venturi system

Wetting of the flue-gas in this way leads to the collection of small particles into larger heavier droplets, which are captured more easily in the separator. This overcomes the difficulties experienced in removing fine particles by inertial methods. A high initial relative velocity between the droplets and the particulates is required to ensure that the captured particles are retained on the droplets when the droplets have accelerated to their terminal velocity. The scrubbed gas and entrained droplets containing trapped particulates enter the diverging section where further collision and agglomeration take place.

Moving-bed scrubbers for particulate collection are packed with low-density plastic spheres, which are free to move within the packing retainers, as shown in Figure 3.17. Particulate collection may be enhanced by using several moving-bed stages in series. Moving-bed scrubbers commonly employ countercurrent flows. The packing is kept in constant motion by the flue-gas and the scrubbing liquid. Hence, the continued motion of the packing considerably reduces any tendency for the bed to plug.

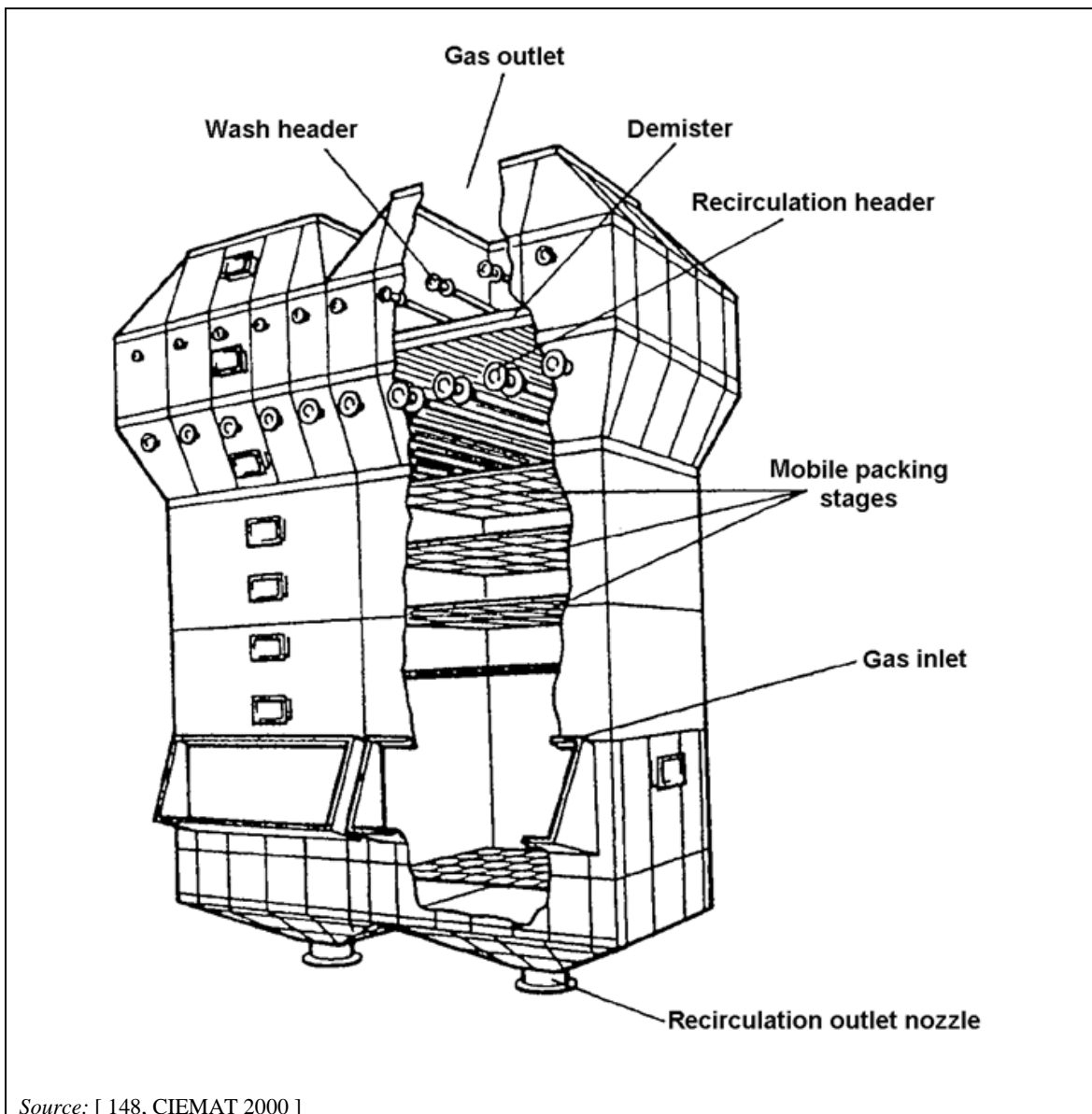

Figure 3.17: Moving-bed scrubber

Achieved environmental benefits

Reduction of dust emissions.

Environmental performance and operational data

Many of these scrubbers are designed for combined particulate removal and control of sulphur dioxide emissions, utilising the alkaline fly ash as sorbent. Lime is frequently added to boost SO₂ removal efficiencies.

The pressure drop and venturi performance are largely dependent on the gas velocity through the venturi. In order to accommodate efficient operation at reduced boiler loads, some venturis are designed with variable throats, which can be operated close to a constant pressure drop, independent of the flue-gas flow rate (boiler load). The venturi itself is followed by a separating section for the elimination of entrained droplets.

The separation efficiency of moving-bed scrubbers is good when processing moderate dust loads. However, this technique is not very suitable for high ash content fuels.

Table 3.8: General performance of wet scrubbers

Technique	Removal efficiency (%)				Other performance parameters	
	< 1 µm	2 µm	5 µm	> 10 µm	Parameter	Value
Wet scrubber (high-energy venturi)	98.5	99.5	99.9	> 99.9	Energy consumption as % of electric capacity	Up to 3 % (5–15 (kWh/1000 m ³))
					Liquid to gas ratio	0.8–2.0 l/m ³
					Pressure drop	30–200 (10 ² Pa)
					Residue	Fly ash sludge/slurry
					Residue	Fly ash sludge/slurry

Cross-media effects

Waste waters are produced for which further treatment and discharge may be required.

If the mist eliminators do not work properly, there is a possibility that small water particles, including fly ash, may remain in the flue-gases even after the scrubbing. Large dust loads may cause clogging and can affect the operational availability and effectiveness of the scrubber unit.

Technical considerations relevant to applicability

The use of wet scrubbers is not commonly applied for the control of particulate emissions. However, wet scrubbers have been used in some high-temperature and -pressure combustion applications, such as integrated gasification combined cycle (IGCC) and pressurised fluidised bed combustion (PFBC). Here, the pressure drop experienced is less significant in relation to the operating pressure, and in IGCC the problem of reheating is overcome as the gas is subsequently heated by combustion.

Economics

Investment costs include the reactor, a possible sorbent injection system, and a waste water treatment plant. Operating costs are mainly related to water consumption and energy costs. Condensing scrubbers cool the flue-gases, and the absorbed heat can be used, for example, for district heating. This improves the economics of the technique.

The capital cost of wet scrubbers is generally lower than for ESPs and bag filters, which make them potentially attractive for industrial-scale use. However, this may be offset by a relatively high pressure drop and operating costs and also other additional costs that may be linked to the possible need for a water treatment plant, bigger fan and flue-gas bypass if the plant cannot be stopped in case of a problem with the cooling system. The flue-gas is cooled during wet scrubbing and requires reheating prior to emission to the atmosphere; this incurs higher energy costs.

The majority of wet scrubbers for collecting fly ash from coal-fired boilers (industrial or utility) are installed in the US. The greatest concentration of these units is in the western US, where fly ash from the available low-sulphur coal is so highly resistive that ESPs are less economically attractive.

Driving force for implementation

No information provided.

Example plants

No information provided.

Reference literature

No information provided.

3.2.2.2 Techniques to prevent and/or reduce SO_x emissions

3.2.2.2.1 Wet lime/limestone scrubbers

Description

Scrubbing technique where sulphur is removed from flue-gases through injection of a slurry of lime/limestone sorbent (liquid solution) into the scrubbing suspension to capture SO₂ and transform it into gypsum. In the wet scrubbing process, gaseous compounds are dissolved in a suitable liquid (water or alkaline solution). Simultaneous removal of solid and gaseous compounds may be achieved. Downstream of the wet scrubber, the flue-gases are saturated with water and separation of the droplets is required before discharging the flue-gases. The resulting liquid has to be treated by a waste water process and the insoluble matter is collected by sedimentation or filtration.

Technical description

Figure 3.18 shows a typical flow diagram of a type of wet lime/limestone FGD system. Limestone is commonly used as a reagent because it is present in large amounts in many countries and is usually much cheaper than other reagents. Lime was commonly used as a reagent in earlier plants because of its better reactivity with SO₂. However, lime has been replaced by limestone to reduce the risk of lime calcination, which is energy-intensive, costly, and time-consuming to repair. Nevertheless, in some cases, lime has to be used instead of limestone due to the whiteness requirements of the FGD gypsum users. In any case, FGD using limestone can achieve almost the same SO₂ removal as lime. The reactivity of limestone has an important influence on the efficiency of a FGD system; however, at present there is no standard or normalised method to test reactivities. Other reagents, such as magnesium-enhanced lime, are also used.

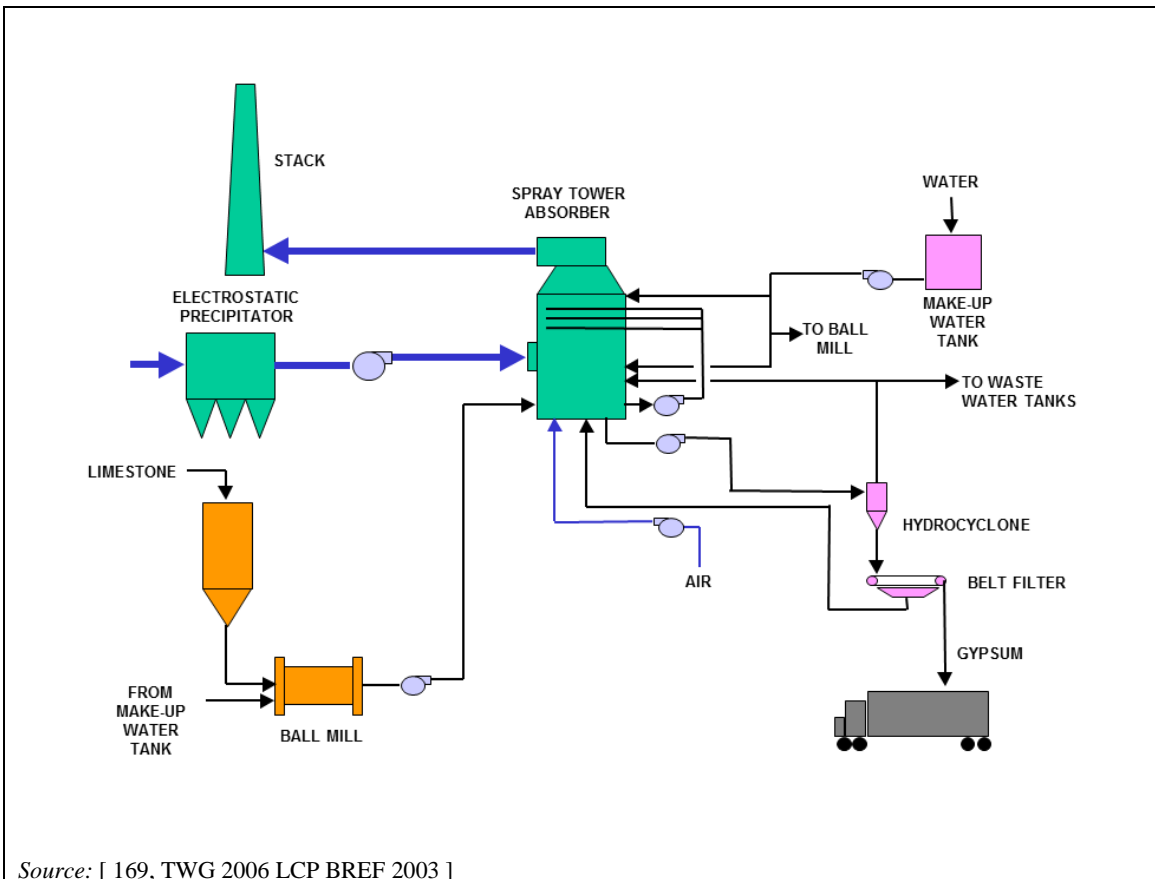

Source: [169, TWG 2006 LCP BREF 2003]

Figure 3.18: Schematic flow diagram of a lime/limestone wet scrubber FGD process

The flue-gas leaving the particulate control system usually passes through a heat exchanger and enters the FGD absorber, in which SO_2 is removed by direct contact with an aqueous suspension of finely ground limestone, where the CaCO_3 content of the limestone should be more than 95 % CaCO_3 . Fresh limestone slurry is continuously charged into the absorber. The scrubbed flue-gas passes through the mist eliminator and is emitted to the atmosphere from a stack or a cooling tower. Reaction products are withdrawn from the absorber and sent for dewatering and further processing.

Wet limestone scrubbers are generally divided into two categories according to the type of oxidation: forced oxidation and natural oxidation. The mode of oxidation is determined by the chemical reactions, the pH of the reagent slurry and the resulting by-product. In forced oxidation mode with a pH range of 5 to 6, which is common in wet limestone scrubbers, the chemical reactions are as follows:

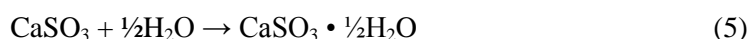
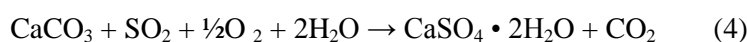

Reactions (1) and (2) are common to all wet FGD systems. Reaction (3) shows the forced oxidation of calcium sulphite by air and the formation (crystallisation) of calcium sulphate dihydrate or gypsum in the oxidation mode. In forced oxidation mode, air is introduced into the bottom of the absorber to oxidise calcium sulphite to calcium sulphate, achieving over 99 % oxidation.

In natural oxidation mode, calcium sulphite is partly oxidised by the oxygen contained in the flue-gas. The main product is calcium sulphite hemihydrate (5). The produced mixture of calcium sulphite hemihydrate and gypsum is in a sludge form.

At the lower pH range of 4.5 to 5.5, the chemical reaction is different. After SO₂ absorption (1), the primary product of the neutralisation by limestone is not calcium sulphite, but calcium bisulphite Ca(HSO₃)₂:

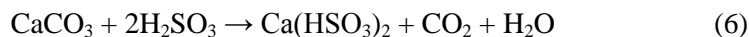

Calcium bisulphite is much more soluble than calcium sulphite. Hence, operation in the lower pH range has less risk of scaling and plugging. Calcium bisulphite is oxidised and crystallised to form gypsum or calcium sulphate dihydrate (7).

Table 3.9 shows a comparison between the forced oxidation and natural oxidation modes in the wet limestone scrubber. In forced oxidation, dewatering is easy because the gypsum crystals are relatively large. The primary dewatering is usually accomplished by hydrocyclones, followed by secondary dewatering in filters or centrifuges. The final product, containing about 90 % solids, is easy to handle and is either sold mainly as gypsum for plaster, cement and wallboard, thereby replacing natural gypsum, utilised to fill mines, or landfilled. Selling the gypsum may contribute to an overall reduction of the total operating costs. Saleable gypsum, however, requires washing during the secondary dewatering step to remove soluble salts such as chlorides.

Table 3.9: Comparison between forced and natural oxidation

Mode	By-product	Size of by-product crystal	Use of by-product	Dewatering	Reliability	Region used
Forced oxidation	Gypsum 90 %; water 10 %	0–100 μm	Wallboard, cement, etc.	Easy: hydro- cyclone plus filter	> 99 %	Europe and Japan
Natural oxidation	Calcium sulphate/sulphite 50–60 %; water 40–50 %	1–5 μm	No use (landfill)	Not easy: thickener plus filter	95–99 % due to scaling problems	US

The by-product from the natural oxidation mode is a mixture which is difficult to dewater. This mixture is calcium sulphite hemihydrate and calcium sulphate dihydrate. Primary dewatering therefore requires a thickener. Secondary dewatering is undertaken with filters or centrifuges. The final by-product remains 40–50 % water. In many cases it is ponded or landfilled but needs blending first with fly ash and lime because of its thixotropic nature. The natural oxidation process was applied mainly in the US but is no longer common for new plants. Its reliability has been improved but still remains only about 95–99 % due to gypsum scaling problems. There is a tendency to convert from natural oxidation to forced oxidation because the resulting gypsum is preferable to the sludge obtained with natural oxidation, even for landfilling purposes.

The configuration of wet limestone scrubbers can generally be classified into four types (a, b, c and d) as shown in Figure 3.19. Types (c) and (d) are shown here in forced oxidation mode, but could be changed to natural oxidation by eliminating air entry in the oxidation vessel; in this case the residue would not be gypsum but sludge.

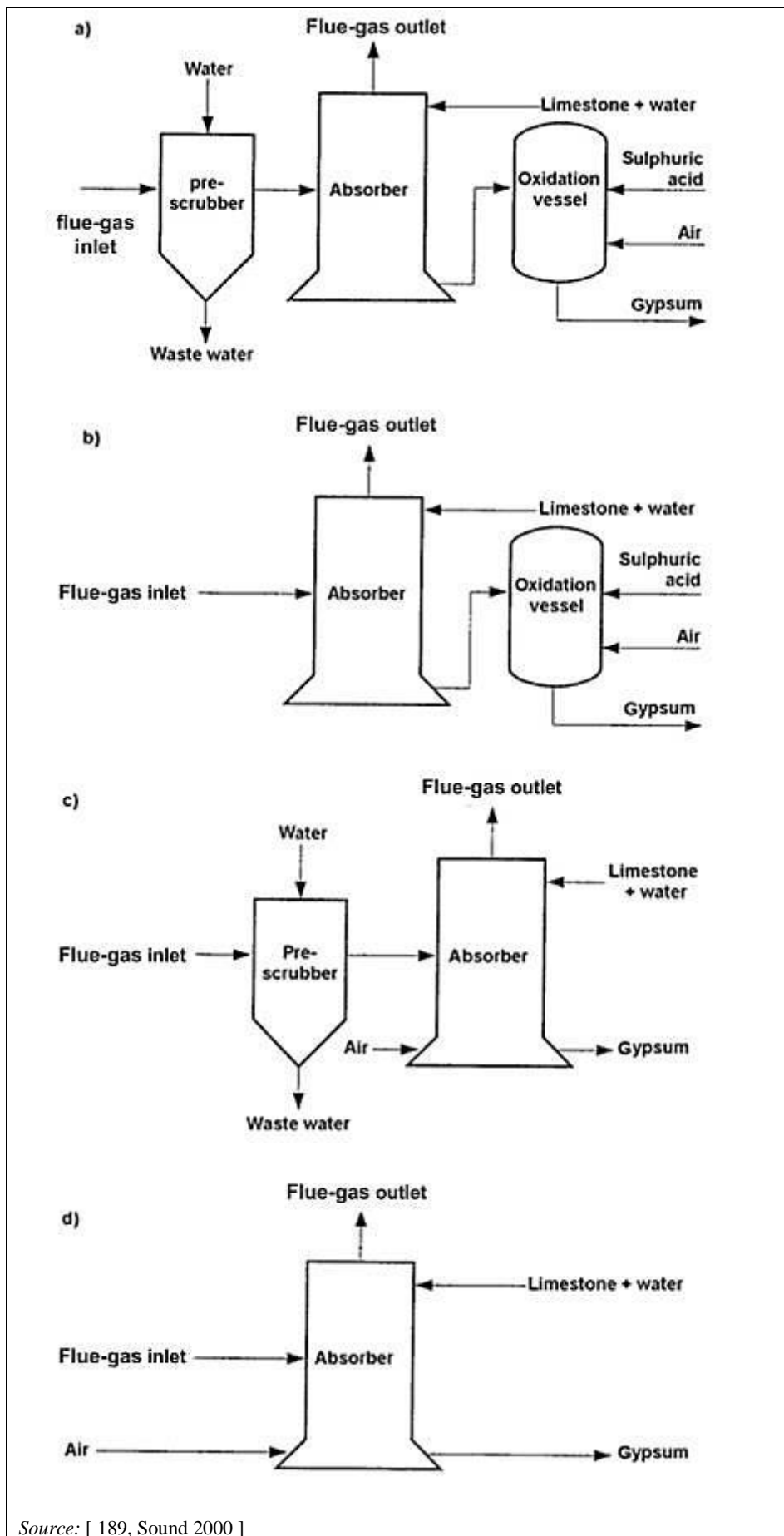

Figure 3.19: Different types of lime/limestone wet scrubbers

Type (a) and **type (b)** use an additional oxidation vessel and are not presented and discussed here, because oxidation vessels have only been used in research.

Type (c) does not have a separate oxidation vessel. Here, the oxidation air is purged into the bottom of the absorber to form gypsum. This oxidation method is usually called *in situ* oxidation and is now the most common method. When oxidation occurs in an oxidation vessel, such as with types (a) and (b), the process is called *ex situ* oxidation. Although the pre-scrubber is primarily used to remove HCl and HF, a low-pH pre-scrubber also removes more mercury, as well as any fine particulates which may be carrying other trace elements. In Japan, many of the new, large FGD plants have adopted type (c) because of the high-quality gypsum that results and its high operational reliability, avoiding possible problems which may occur without the pre-scrubber.

Eliminating the oxidation vessel or conversion from *ex situ* to *in situ* oxidation is a major development in FGD technology. *In situ* oxidation has many advantages over *ex situ* oxidation:

- First of all, *in situ* oxidation prevents scaling and plugging problems through complete oxidation of the product in the absorber, resulting in a higher operational reliability. Partial oxidation of the product, due to the oxygen in the flue-gas, causes gypsum scaling in the absorber.
- Secondly, *in situ* oxidation achieves a higher SO₂ removal efficiency than *ex situ* oxidation.
- Thirdly, it is important to note that *in situ* oxidation promotes SO₂ removal efficiency even at low pH values because the H₂SO₄, which is produced by oxidation of H₂SO₃ through air injection, rapidly reacts with limestone. In addition, the utilisation of limestone is higher than in *ex situ* oxidation because of the higher solubility of limestone at low pH values. The Ca/S molar ratio ranges from 1.02 to 1.1.

A further advantage of *in situ* oxidation is that it is possible to reduce the formation of S₂O₃. This is a by-product of the side reaction of SO₂ oxidation and is one of the chemical oxygen demand (COD) substances. Decreasing the COD to as low as one fifth to one tenth in the waste water can reduce the requirement for waste water treatment. There is also no need to add H₂SO₄ for oxidation, unlike with types (a) and (b). The emergence of *in situ* forced oxidation has made the wet limestone scrubber more attractive.

Type (d) is the simplest configuration in wet limestone scrubbers and has now become the leading FGD system. All chemical reactions are operated in an integrated single absorber. This can reduce the capital costs and the power consumption. Type (d) has achieved a high operational reliability and has produced a reasonable quality of gypsum since the late 1980s. An integrated single tower also requires less space, facilitating the retrofit to existing boilers. In Germany, the most recent FGD installations are type (d). In the US, type (d) is also popular due to its lower costs and high efficiency.

The design of the absorber is crucial in wet FGD systems. Figure 3.20 shows examples of different types of absorbers where all FGD chemical reactions occur together.

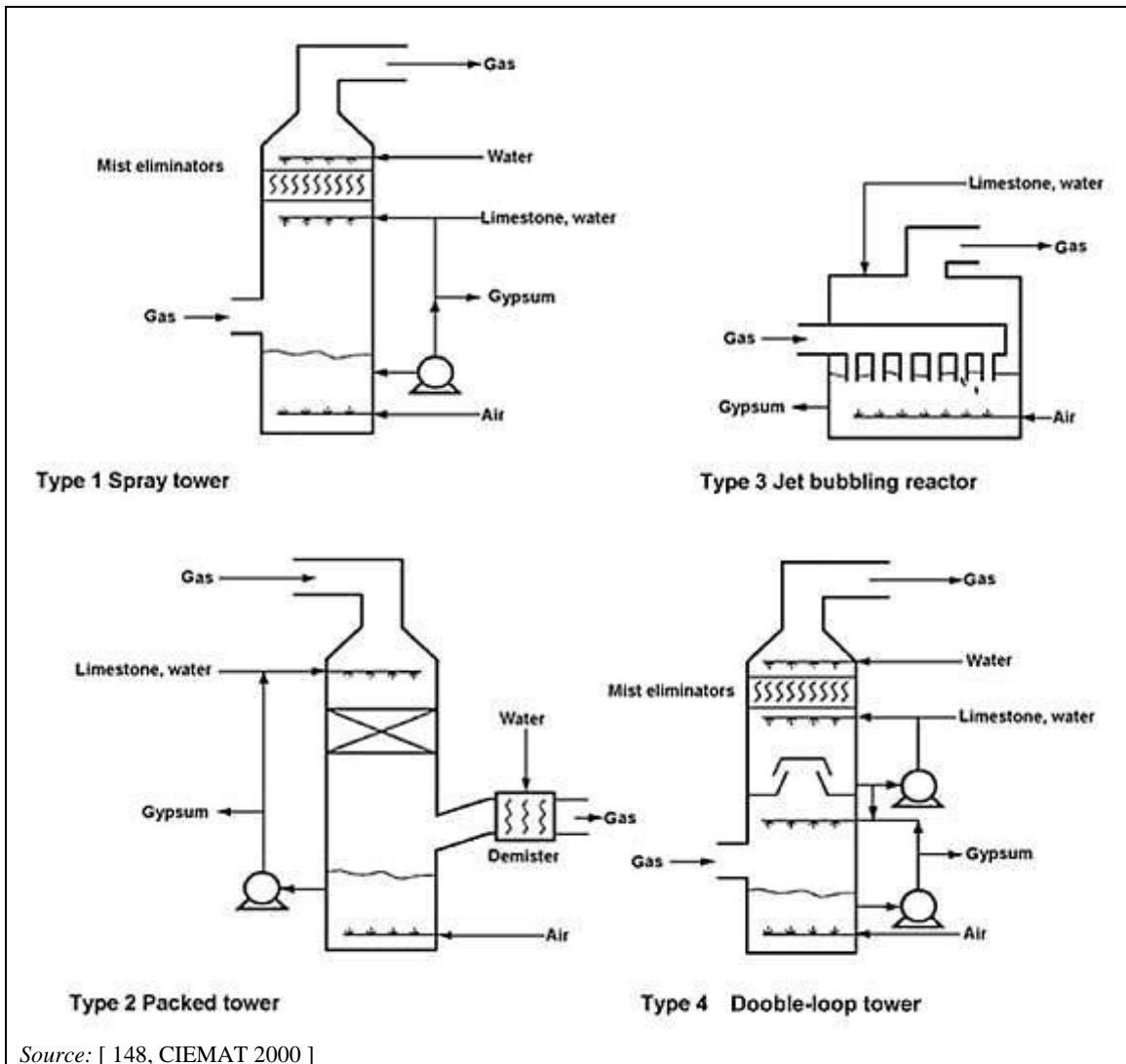

Source: [148, CIEMAT 2000]

Figure 3.20: Different absorber types

Type 1 is the **spray tower absorber** and is the most commonly used in wet FGD systems throughout the world. The spray tower normally has three to four spray heads with a number of spray nozzles through which an aqueous suspension of gypsum slurry containing finely ground limestone is atomised and sprayed with uniform distribution. The flue-gas introduced into the absorber is in close contact with freely moving droplets, usually in a countercurrent configuration with no devices restricting the gas flow. Liquid mists carried over are captured by mist eliminators. This design was developed to cope with the scaling problems of the first generation of FGD systems equipped with internally structured absorbers.

Type 2 is the **packed tower absorber** using plastic grid packing, originally developed in Japan. The packed tower lengthens the residence time for gas-liquid contact, resulting in higher SO_2 removal efficiencies. The packed tower is now operated without scaling problems, due to an improved understanding of FGD processes. Moreover, the important feature of the high-velocity co-current gas flow configuration is the compact design for the large-scale absorber.

Type 3 is known as the **turbulent bubble bed or jet bubbling reactor**. The flue-gas is injected into slurry through numerous submerged pipes while limestone slurry is fed into the turbulent bubble bed reactor and air for oxidation is blown into the slurry. The absorber type is a good example of a simplified FGD process. It eliminates the need for recycle pumps, spray nozzles and headers, separate oxidation tanks and thickeners, thereby minimising difficulties as well as power consumption.

Type 4 uses a **double-loop concept** originally pioneered in the US. This absorber is in two loops described as a quencher and an absorber, each having different pH values with each function. A number of plants using this type of absorber have been installed in Canada, Germany and the US.

Other systems combining these absorber types have also been implemented from the mid-2000s, like the wet FGD system shown in Figure 3.21 combining absorber types 1 and 2 in a co-current and countercurrent system.

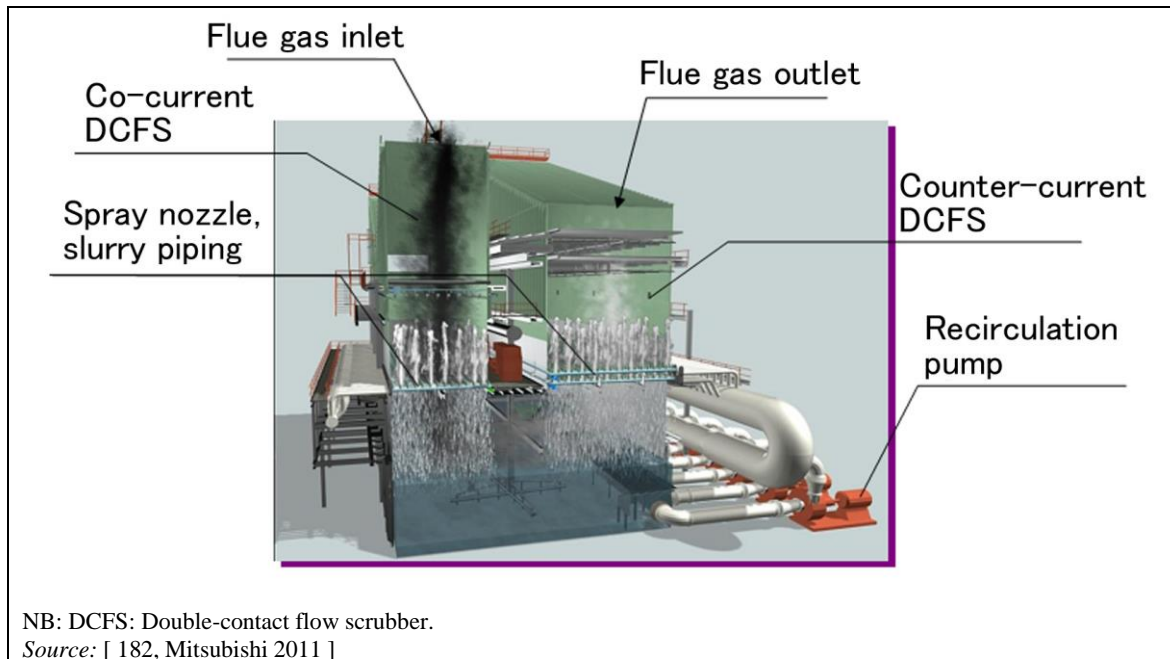

Figure 3.21: Example of a co-current and counter-current wet FGD system

Wet limestone FGD systems naturally suffer from an aggressive operating environment, leading to corrosion, erosion and abrasion. The flue-gas path from the inlet of the absorber to the stack discharge must be protected, for instance using rubber or flake linings, against acid attack caused by the adiabatic cooling and saturation of the gas. The components of particular concern are the inlet duct, absorber, outlet duct reheat systems and the stack liners. All slurry-handling parts are subject to both corrosive and abrasive attacks. These include spray zones, tanks, agitators, pumps, pipes, valves and all dewatering equipment.

The flue-gas temperature is reduced to about 45–80 °C by passing it through the wet FGD units. To improve the dispersion of the clean flue-gas from the stack and to reduce the frequency of occurrence of a visible plume, regulations require a minimum flue-gas temperature at the stack outlet. To meet this requirement the flue-gas needs to be reheated. The regenerative gas-gas heat exchanger (reheater) is most commonly used to reheat the flue-gas. Some new regulations no longer require a minimum temperature at the stack. Furthermore, discharging the clean flue-gas via a wet stack requires less electrical power, although there is a visible plume effect.

Dispersion models have shown that the stack height is much more important for flue-gas dispersion than the discharge gas buoyancy, to ensure a low impact on air quality near the site, without reheating of the flue-gas. The discharge gas' buoyancy (and hence dispersion) can be increased if necessary by reheating the flue-gas, but dispersion can also be improved by having a higher stack exit velocity.

The application of a wet FGD system requires considerable space. In existing plants, where FGD was not originally included as part of the process, there may be a lack of available space and extra ductwork may be needed, resulting in much higher investment costs.

When implementing this process in an existing installation, a new stack may also need to be built, because the exhaust gases from the FGD are much more corrosive (the dew point is reached in the scrubber) than those from installations without FGD treatment, and the existing stack may not be designed or suitable for this purpose. These new stacks can take advantage of modern flue linings that both reduce acid condensate and improve dispersion by heating up quickly during start-up. This is becoming increasingly important as developments in the electricity market result in more plants being operated intermittently to adapt to the demand.

Wet scrubber processes have undergone considerable development in the last few decades, leading to improved reliability and removal efficiencies, as well as reduced costs. Reliability is normally over 99 % with forced oxidation, and 95–99 % with natural oxidation. The applicability may be influenced by both scrubber components and auxiliary processes connected to the absorber process.

A process involving hydroxide and sulphide precipitation, clarification and slurry dewatering has been found to be a good measure for the waste water treatment after the FGD plant to remove metals and suspended solids.

Achieved environmental benefits

Reduced SO_x, HCl, HF, dust and particle-bound metal emissions to air.

Environmental performance and operational data

Table 3.10: Performance of the wet lime/limestone scrubber technique for reducing sulphur oxide emissions

Technique	General SO ₂ reduction rate	Other performance parameters	
		Parameter	Value
Wet lime/ limestone scrubber	92 % to > 99 % (depending on the absorber type)	Operating temperature	45–60 °C
		Sorbent	Limestone, lime, chalk
		Energy consumption as % of electrical capacity	1–3 %
		Pressure drop	20–30 (10 ² Pa) (without gas-gas heater)
		Ca/S molar ratio	1.02–1.1
		Reliability	95–99 % (of operating time)
		Residue/by-product	Gypsum
		Gypsum purity	90–95 %
		Residence time	< 5–10 s
		Lifetime of rubber lining	> 10 years (coal)
		SO ₃ aerosol removal rate	50 %
		HCl removal rate	90–99 %
		HF removal rate	90–99 % in the absorber
		Particulate	> 50 % (e.g. in the case of coal combustion; for other fuels, it depends on the particle size)
Raw water consumption	220–250 l/MWh _e In a diesel power plant without heat recovery, about 1.1 m ³ /MWh _e		
NB: The SO ₂ reduction rate for some existing FGD units starts at 85 %. Of the total installed FGD capacity, 80 % are wet scrubbers, of which 72 % use limestone as the reagent, 16 % use lime and 12 % use other reagents. The selection of limestone (high calcium carbonate content; low Al, F and Cl content) is important to ensure a good SO ₂ removal rate. The distance the limestone has to travel to the plant and the reactivity of the limestone are also two important factors to take into account. Sometimes organic buffers are used to maintain the pH value of the scrubbing solution, thus enhancing the SO ₂ removal or limiting the lime/limestone needed for the reaction. The operating temperature may be as high as 75 °C when using lignite with a low calorific value and high moisture content. Gypsum may be a saleable by-product.			

The removal efficiency is a function of the downward liquid flow rate compared with the upward flue-gas flow rate (the so-called liquid to gas ratio and the resulting contact time and volume within the absorber. It depends also to some extent on the type of packing used, the temperature of the water and the addition of chemicals. Limiting factors for removal efficiency include the vessel size and pathways, pump capacities, pipework sizes and configurations and sump size.

Within these limitations, in principle a number of options exist to improve the performance of the FGD system. They generally fall into two categories, those that improve the contact of the flue-gas with the liquor within the absorber tower, and those that improve the chemistry of the process itself. Examples of the former include: wall rings, interspatial spray level, improved header and nozzle, and tray.

An example of the latter is chemical dosing, such as the use of organic acids, to modify or optimise the pH. Adding an organic acid (or organic buffer), such as adipic acid, to a limestone FGD system increases the capacity of the slurry liquid to absorb SO₂ by buffering the pH in the

absorber. The operating pH, optimally 5.0–5.1, permitted for an adipic-acid-enhanced system is lower compared to the 5.1–5.5 pH usually required for an unenhanced limestone system. By this means, the SO₂ removal efficiency can be improved and/or the desulphurisation costs may be lowered, mainly by saving limestone and reducing the energy demand to run recirculation pumps. [14, MOBLEY et al. 1986] [15, WANG and BURBANK 1982]

The use of organic acids, such as adipic acid, in existing installations equipped with wet FGD designed for an outlet SO₂ concentration of ~400 mg/Nm³ has been shown in some plants to improve the FGD performance but there are associated side effects such as increased BOD (biochemical oxygen demand) in the waste waters, requiring additional treatment equipment. [121, Eurelectric 2012]

One option that falls between these groups is the omission of the gas-gas heater. This may improve performance by reducing the risk of a small percentage of flue-gas passing from the raw flue-gas side of the heater to the clean flue-gas side without being treated.

The performance achievable by these measures is highly site-specific and a range is outlined in Table 3.11.

Table 3.11: Potential performance improvement options

Measure	Performance improvement
Wall rings	3–5 %
Interspatial spray level	3–5 %
Improved header and nozzle	3–5 %
Chemical additives	1–6 %
Tray	2–7.5 %
<i>Source:</i> [183, UK-TWG 2011]	

The performance of these measures will, to some extent, be subject to a diminishing return, or to put it another way, the better performing the base unit, the less scope there is to improve its performance, and so improvements may be even lower than the bottom end of the range cited. Additionally where the gas-liquid contact is already good, little, if any, performance change would be seen by adding an extra gas-liquid contact measure. This also holds for chemistry improvements where the chemistry is already good.

Concerning the desulphurisation of flue-gases from liquid-fuel-fired engines, a larger diesel engine, for example, has an oxygen content of about 13–15 vol-% in the flue-gas (air factor 2.7–3.5). A boiler plant typically has 3–6 vol-% O₂ (air factor 1.2–1.4), depending on the fuel used. A higher oxygen content means a larger exhaust gas flow and the need for a larger FGD reactor system, which leads to a higher investment cost per kW_e, than mentioned above.

Cross-media effects

- Waste water generation with potential BOD increase in waste waters if using organic acids.
- High water consumption.
- Reduction of the combustion plant's energy efficiency.
- When flue-gas reheating is required prior to the wet FGD system, the energy loss is large compared to dry FGD systems and combined SO₂/NO_x removal systems, which do not generally require flue-gas reheating.
- A problem associated with the use of rotating gas-gas heat exchangers operating at about 150 °C is the inherent internal flue-gas leakage, with 1–3 % of the raw flue-gas going

directly to the stack without a reduction of the SO₂ content. Therefore, in order to achieve the prescribed stack SO_x emission level, the equipment needs to be designed for more efficient SO_x removal, which may influence the reagent consumption and required quality. Solutions are the use of a leakage reduction system, enabling a decrease of the leakage down to 0.5 %; or the replacement of the gas-gas heater downstream of the wet FGD system by a multi-pipe heat extractor, e.g. when the heat exchanger needs to be changed or replaced; or removal and discharge of the flue-gas via a cooling tower or a wet stack.

Technical considerations relevant to applicability

Retrofitting to existing plants may be difficult because of the space requirements for scrubbers and ancillary equipment because of their size and/or complex modifications to existing flue-gas piping systems.

Existing plants that have already applied a wet FGD system can reduce the SO₂ emissions by optimising the flow pattern in the absorber vessel.

Economics

The capital costs are relatively high for a wet limestone scrubber, but the operating costs are moderate due to the advanced automation, the reliability, and the saleable by-product. The capital costs can vary widely. They depend on the site specifications and technical and economic conditions, such as plant size, SO₂ inlet and outlet concentrations, the redundancy strategy, annual operating hours, operating years, management of gypsum or residues, raw water cost and quality, interest rates, number of units on site, FGD market situation, etc.

The capital cost for the wet lime/limestone scrubber process is mainly influenced by the flue-gas flow rate and other site-specific factors such as plant layout, available space and necessary modifications to existing plants. In some cases these factors might be expected to increase the costs by some 50 %. FGD retrofit installations are much more expensive than greenfield installations. The capital costs for a wet limestone scrubbing process fitted to a boiler varies from EUR 35–50 per kW_e for a new plant to EUR 60–300 per kW_e in the case of retrofits. Operation and maintenance costs are between EUR 0.4 and EUR 0.7 per MWh (energy input). The typical SO₂ removal costs are between EUR 750 and EUR 1150 per tonne of SO₂ removed, which corresponds to an impact of EUR 3–6 per MWh on the cost of electricity production.

[3, LCP TWG 2012]

Regarding the upgrade of existing wet FGD systems, a study performed for the UK EPA identified a case where the extra cost for reducing SO₂ from 800 mg/Nm³ to 400 mg/Nm³ in a 500 MW unit was about GBP 7.5 million. This required an extra slurry pump, an extra spray level and an increase in the height of the absorber. Extra limestone was required which necessitated larger limestone milling equipment and increases in size throughout the limestone-handling system. Similarly there was an increase in equipment size for gypsum handling. The study concluded that a reasonable estimate for the increase in capital costs for going from 200 mg/Nm³ to 100 mg/Nm³ would be GBP 5 million. [183, UK-TWG 2011]

Driving force for implementation

Reduction of SO_x, HCl, HF, dust and particle-bound metal emissions.

Example plants

See sections on coal, lignite, biomass, peat and oil combustion.

Reference literature

No information provided.

3.2.2.2 Seawater scrubber

Description

A specific non-regenerative type of scrubbing using seawater, due to its alkalinity, as a solvent in locations where a large volume of seawater is available.

Technical description

Seawater scrubbing utilises seawater's inherent properties to absorb and neutralise sulphur dioxide in flue-gases. If a large volume of seawater is available near a combustion plant, it is likely to be used as a cooling medium in the condensers. Downstream of the condensers the seawater can be reused for FGD. The basic principles of the seawater scrubbing process can be seen in Figure 3.22.

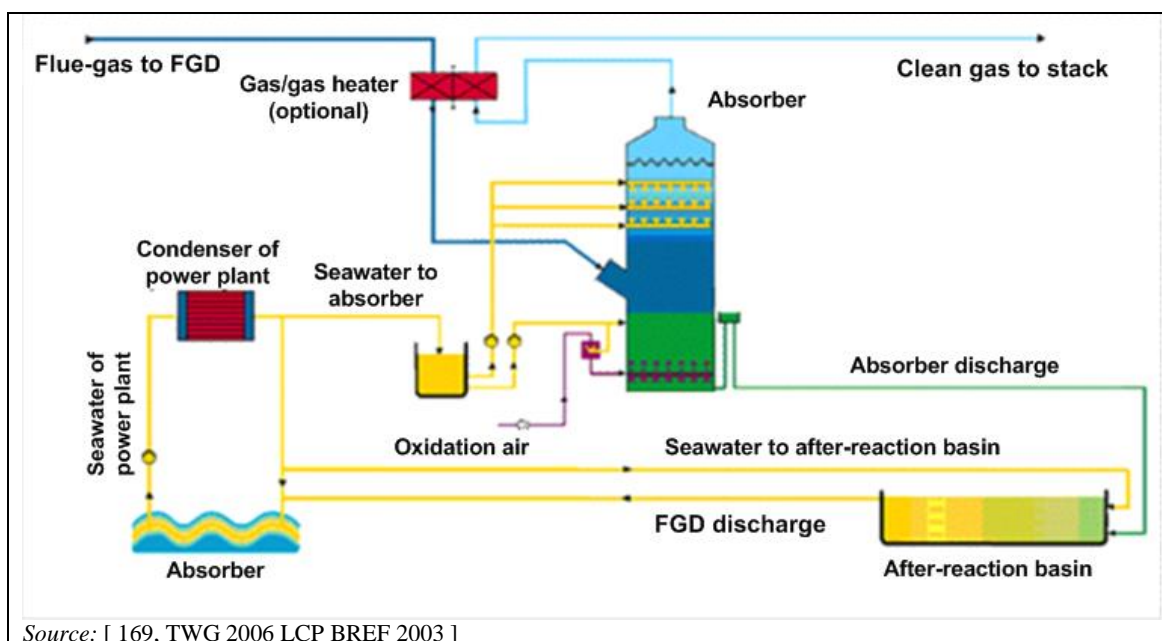
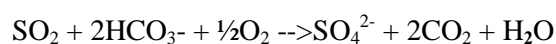

Figure 3.22: Seawater scrubbing process

The flue-gas from the combustion plant leaves the dust collector, normally a bag filter or an electrostatic precipitator, and is then fed to the SO₂ absorber, where it comes into contact with a controlled proportion of the seawater, taken from the cooling water outflow of the steam turbine condenser. Due to the presence of bicarbonate and carbonates in the seawater, the sulphur dioxide of the flue-gas is absorbed. The acidified absorber effluent is mixed with additional seawater to ensure that the pH is at the optimal level for the oxidation process. The introduced air forces the oxidation of the absorbed sulphur dioxide from bisulphite to bisulphate and removes dissolved CO₂. The water will be nearly saturated with oxygen and the pH value will be restored to neutral before the seawater is discharged back to the sea. The seawater process does not involve any import or export of reagents or solid by-products. It only uses seawater that has already been used in the power or heat generation process as cooling water for the steam turbine condenser.

The process is based on the following chemical reaction:



Systems incorporate dampers (commonly referred to as modulators), which allow variable amounts of flue-gas to bypass the FGD units. This is useful as a safety measure and in some designs offers a way of increasing flue-gas emission temperatures to improve dispersion (see

below). Their use can also prevent low-pH water discharges, should other potential actions, such as use of additional energy-intensive aeration blowers, be considered inadequate or not rapid enough.

Flue-gas reheating is incorporated into all systems to improve the flue-gas dispersion of a discharge that would otherwise be close to seawater temperature. This is carried out by either a gas-gas reheater or by an untreated gas and hot bypass gas mixer. The seawater process removes moisture from the flue-gas to a dew point close to seawater temperature, generally lower than local atmospheric temperatures, such that a stack plume is not generally visible.

In some estuarine locations, an influx of fresh or brackish water, for example after long periods of precipitation, can affect seawater's alkalinity and therefore its ability to remove SO₂. At low tide in estuarine locations, there may be recirculation between the cooling water outfall and intake. This can in turn affect the efficiency of SO₂ removal and the acidity of the discharged cooling water, requiring the partial bypassing of one or more of the FGD absorbers using the modulators mentioned above. [184, UK 2013]

Achieved environmental benefits

- SO_x emissions reduction.
- Simple process which does not require slurry handling and does not generate by-products.
- Reduction of metal emissions to air.

Environmental performance and operational data

Table 3.12: Performance of the seawater scrubber technique for reducing sulphur oxide emissions

Technique	General SO ₂ reduction rate	Other performance parameters	
		Parameter	Value
Seawater scrubbing	85–98 %	Operating temperature (example)	145 °C (example of flue-gas inlet) 30–40 °C (= seawater outlet temperature)
		Sorbent	Seawater, air
		Residence time of seawater in aerator	15 min (example, residence time depends on type of process)
		Max. flue-gas flow per absorber	No limitation in gas flow
		Reliability	98–99 %
		Residue/by-product	None
		Energy consumption as % of electric capacity	0.8–1.6 %
		HCl removal rate	95–99 %
		HF removal rate	95–99 % (in the absorber)
		Waste water	Discharged directly back to the sea (sulphate ions dissolved in seawater)
		Pressure drop	10–20 (10 ² Pa)

NB: Unlike the limestone gypsum system that turns spray levels on and off to match performance to coal sulphur, the seawater absorber only employs a controlled bypass that improves the reheat and reduces cross-media effects to seawater when firing lower sulphur coals.

Cross-media effects

Local conditions such as seawater conditions, tidal flows, the marine (aquatic) environment close to the scrubber water outlet, etc. need to be carefully examined in order to avoid any negative environmental or ecological effects.

Effects may arise from the reduction of the pH level in the general vicinity of the combustion plant, as well as from the input of remaining metals, in particular Hg, and fly ash. This is especially relevant for plants situated in an estuary. Injection of activated carbon in the flue-gas stream together with the use of a bag filter, upstream of the seawater FGD, enables the reduction of mercury emissions to water. The discharge to water will contain sulphate and chlorine ions, which are natural constituents of seawater. [184, UK 2013] [120, EEB 2013]

Another cross-media effect is the reduction of the combustion plant's energy efficiency.

Technical considerations relevant to applicability

- Seawater must be available and already used as cooling water.
- The applicability of seawater scrubbing is very high, as the process is simple and does not require slurry handling. However, it is applicable only for low-sulphur fuel.
- Because particulates (possibly including their metals content) are transferred to the seawater, an efficient particulate abatement technique is necessary prior to the seawater scrubbing.
- Retrofitting to existing plants can be difficult because of the plot space requirement for scrubbers and ancillary equipment because of their size and/or complex modifications to existing flue-gas piping systems.

Economics

The capital and operating costs are low (no bulk chemicals required, although sometimes magnesium hydroxide is used to enhance the alkalinity).

For a 300–500 MW_e plant fitting a seawater FGD system to achieve a 90 % reduction in SO₂, an indicative capital cost of GBP 110/kW_{el}, and operating costs of GBP 0.0011/kW_{el} (1999 prices) are given. [120, EEB 2013]

Driving force for implementation

Reduction of SO_x, HCl, HF, dust and particle-bound metal emissions.

Example plants

Aberthaw Power Station in Wales in the UK (Plant 493).

Kilroot Power Station in Northern Ireland in the UK.

Reference literature

No information provided.

3.2.2.2.3 Magnesium wet scrubber

Description

Scrubbing technique using seawater as a solvent and using magnesium hydroxide to enhance alkalinity.

Technical description

The reagent in magnesium scrubbing is magnesium hydroxide, which is produced by adding slaked lime to seawater in order to enhance alkalinity. It produces waste sulphate liquor. The magnesium sulphate can be discharged into the sea because magnesium sulphate is a constituent of seawater.

Achieved environmental benefits

Reduced SO_x emissions to air.

Environmental performance and operational data

No information provided.

Cross-media effects

Local conditions such as seawater conditions, tidal flows, the marine (aquatic) environment close to the scrubber water outlet, etc. need to be carefully examined in order to avoid any negative environmental or ecological effects.

Effects may arise from the reduction of the pH level in the general vicinity of the power plant, as well as from the input of remaining metals, in particular Hg, and fly ash. This is especially relevant for plants situated in an estuary.

A further cross-media effect is the reduction of the combustion plant's energy efficiency.

Technical considerations relevant to applicability

This process is suitable only for plants located near the coast.

The magnesium wet scrubber has mainly been applied to smaller plants, i.e. less than 50 MW, and is therefore not described further in this document.

Economics

The capital costs are low, but the operational costs are high.

Driving force for implementation

Reduction of SO_x, HCl, HF, dust and particle-bound metal emissions.

Example plants

A number of units with this process have been constructed, mainly for industrial coal-fired boilers.

Reference literature

No information provided.

3.2.2.2.4 Ammonia wet scrubber**Description**

Scrubbing technique where sulphur is removed from flue-gases through injection of ammonia sorbent for capturing SO₂ and transforming it into ammonium sulphate.

Technical description

In the ammonia wet scrubber, as shown in Figure 3.23, SO₂ is absorbed by aqueous ammonia, resulting in ammonium sulphate as the by-product, which is used as fertiliser.

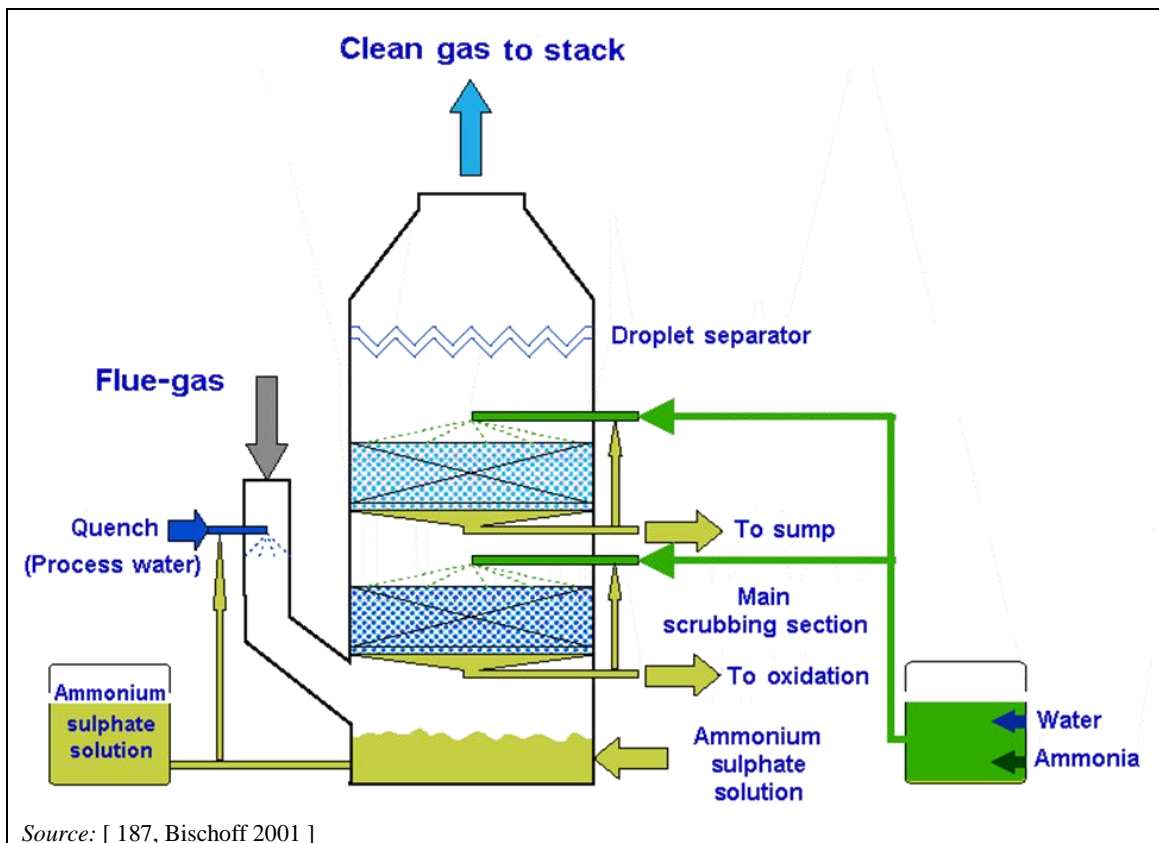

Figure 3.23: The ammonia wet scrubber

Achieved environmental benefits

Reduced SO_x emissions to air.

Environmental performance and operational data

The technique has been operating reliably following improvements and the resolution of some initial problems with the generation of aerosols, i.e. ammonia salt particles with a diameter of up to $1 \mu\text{m}$. The process can achieve emission levels of less than 200 mg/Nm^3 .

Cross-media effects

The process does not generate solid by-products or liquid waste. If particulates with possible metals content are present in the flue-gas they appear together with the product.

Another cross-media effect is the reduction of the combustion plant's energy efficiency.

Technical considerations relevant to applicability

No information provided.

Economics

No information provided.

Driving force for implementation

Besides the emissions reduction performance, the driving forces to apply the ammonia wet scrubber are: the requirement for a saleable by-product; the requirement that no waste water results (when local conditions do not allow discharge of waste water into the public watercourse) or other materials that would require waste disposal; very limited space availability; and economic constraints.

Example plants

The process has been operated in a coal-fired, wet-bottom boiler with a 191 MW_e firing capacity in Germany.

Reference literature

No information provided.

3.2.2.2.5 Lye wet scrubber**Description**

Scrubbing technique where sulphur is removed from flue-gases through injection of a NaOH sorbent for capturing SO_x.

Technical description

Some wet scrubbers use a NaOH (about 50 wt-%) water solution (lye) as the reagent. The flue-gas is washed with the reagent water solution and the SO_x is removed. The main components of the system are the reagent storage tank and transportation system, a scrubber with recirculation pumps, and an oxidation tank.

Some of the technical drawbacks of a wet scrubber using a NaOH water solution as the reagent are:

- moderate reduction of flue-gas particles;
- low exhaust gas temperature (detrimental for flue-gas dispersion);
- high water consumption;
- high discharge water flow ('by-product').

All DeSO_x methods need a large amount of make-up water and produce a large amount of end (by-)product, which has to be disposed of in an environmentally sound way. The disposal options for the by-product depend on local and national standards and on the existing infrastructure. Therefore, these are decided on a case-by-case basis.

Achieved environmental benefits

Reduced SO_x emissions to air.

Environmental performance and operational data

No information provided.

Cross-media effects

- High water consumption.
- High discharge water flow ('by-product').
- Reduction of the combustion plant's energy efficiency.

Technical considerations relevant to applicability

No information provided.

Economics

- Lower investment costs compared to other DeSO_x methods (residue treatment costs are not considered, and neither is reheating (depends on the applicable legislation)).
- Expensive reagent.

- In larger power plants, other DeSO_x methods are often more competitive than NaOH DeSO_x, due to lower operating costs (cheaper reagent, etc.).

Driving force for implementation

The driving forces are the lye wet scrubber's simplicity, reliability (no clogging risk) and good SO_x removal efficiency.

Example plants

No information provided.

Reference literature

No information provided.

3.2.2.2.6 Spray dry scrubber/absorber

Description

A suspension/solution of alkaline reagent is introduced and dispersed in the flue-gas stream. The material reacts with the gaseous sulphur species to form a solid powder, which has to be removed by filtration (bag filter or ESP).

Technical description

The spray dry scrubber process belongs to a group of semi-dry processes because it uses lime slurry (mixture of lime and water), similar to the wet scrubber processes, and the residue is dry powder, similar to the dry processes. Lime slurry is usually used to remove SO_x from the flue-gas in this type of FGD scrubbing technique. The process consists mainly of a spray dry absorber; dust control, such as an ESP or a bag filter; and recycling disposal devices for the reaction products. Several spray dry scrubber processes are currently commercially operated. These processes are similar to each other in terms of the process configuration, constituents, and the sorbent used, but one difference is the lime slurry dispersion system used in the spray dry absorber (SDA).

Some installations use a dust control device before the spray dry scrubber for separate collection of the fly ash.

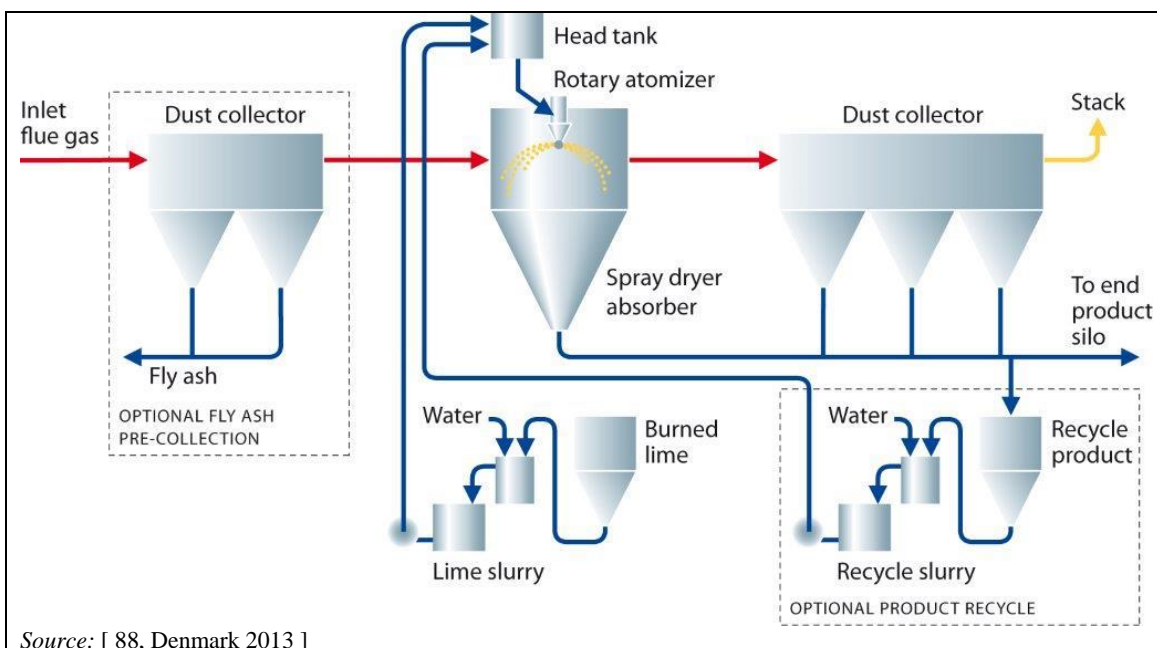

Source: [88, Denmark 2013]

Figure 3.24: Flowsheet of a spray dry scrubber process

The sorbent for the SO_x absorption is typically calcium hydroxide (Ca(OH)₂). The calcium hydroxide can be made from burnt lime (CaO) on site in the slaking process or bought as a powder to be mixed with water to produce the lime slurry, which is also called lime milk. Lime slurry is sprayed as a cloud of fine droplets in the spray dry absorber, where SO_x is also removed from the flue-gas. Water is evaporated by the heat of the flue-gas, usually with a sufficient residence time (about 10 seconds) for the SO₂ and other acid gases such as SO₃ and HCl to react simultaneously with hydrated lime to form calcium sulphite/sulphate and calcium chloride. Waste water treatment is not required in these processes because all the water is completely evaporated in the spray dry absorber. The spray dry scrubber may even be used to eliminate the waste water stream from wet scrubbers and can thus be seen as an excellent zero liquid discharge (ZLD) technique.

The process chemistry associated with SO₂ removal from the flue-gas is a simple acid/base absorption reaction between SO₂ and hydrated lime as follows:

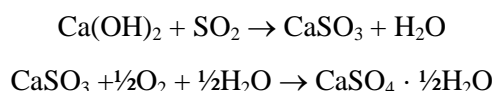

The absorption chemistry is strongly affected by factors such as flue-gas temperature, gas humidity, SO₂ concentration in the flue-gas and atomised slurry droplet size. The by-product is a dry mixture of calcium sulphite, calcium sulphate, fly ash and unreacted lime, which is collected by either the ESP or the bag filter. As this residue contains some unreacted lime, part of it is generally recycled and mixed with fresh lime slurry to enhance lime utilisation. If bag filters are used to remove the solids after scrubbing, the flue-gas normally requires cooling, either by heat exchanger or cooling air, to keep the temperature below 250 °C (except with fabrics suitable for higher temperatures, such as ceramics or metal gauze/mesh).

The use of a pre-collector, which removes most of the fly ash before it enters the absorber, is a common design feature of most European spray dry scrubber plants. It is installed between the air heater and the absorber. The installation of a pre-collector has some advantages that can help to balance its initial capital and operating costs, e.g.:

- For a given desulphurisation yield, it can reduce the lime consumption (at a given ΔT). Although this requires the SD scrubber operating temperature to be increased (at a given Ca/S ratio), this also reduces dust deposition risks.
- It helps to achieve a greater ESP efficiency and, therefore, lower final emissions.
- It stops erosion of the equipment downstream by the fly ash.
- It reduces the volume of waste for disposal.
- It collects a saleable product (fly ash), which is useful as the market for fly ash is well established.

The pre-collector is normally a simple one-field ESP. However, in retrofits the existing particulate control equipment is often used as a pre-collector.

Slurry or detention-type slakers are typically used in Europe and the US, followed by paste slakers (used more commonly in the US). The simple tank slaker can be used for pulverised quicklime.

The main part of the absorber is the lime slurry spray system. The spray system can be of the rotary atomiser type or of the dual-fluid nozzle type. The first one is installed at the centre of the roof and sprays fine droplets of hydrated lime. For large flue-gas flows (above 850 000 Nm³/hr), the flue-gas stream is split prior to entering the absorber, so that approximately 60 % of the gas enters the absorber through the roof gas disperser and the other 40 % through the central gas

dispenser. Adjusting the two flows and correct positioning of the gas dispersal vanes help to control the shape of the cloud of atomised droplets and provide an efficient mixing of the flue-gas and sorbent in a narrow zone around the atomiser. The appropriate size of absorber for treating the flue-gas from boilers with a 150–200 MW_e capacity is usually 14–15 m (diameter) x 11–12 m (cylindrical height).

The spray nozzles of the slurry atomiser in the spray dry absorber have to conform to high specifications to maintain a constant spraying quality. For example, the nozzles must be able to resist flue-gas corrosion and lime erosion. In addition, they must have a low pressure drop and a minimal risk of clogging. Many types of spray nozzle are used in the slurry atomiser, such as the rotary atomiser and the stationary dual-fluid nozzle.

Sorbent utilisation in spray dry scrubbers is higher than in sorbent injection processes, but unreacted lime constitutes about 10–40 % of the make-up lime and is discharged from the system with calcium sulphite/sulphate. The sorbent utilisation is improved by strictly controlling the sorbent to water ratio in slurry making, decreasing the approach-to-saturation temperature in the absorber and by recirculating parts of the residue back to the absorber.

Achieved environmental benefits

- Reduction of SO_x emissions to air.
- No waste water generated.
- Investigation showed that about 35–85 % of the mercury present in the gas phase upstream of the scrubber is removed.

Environmental performance and operational data

Spray dry absorbers usually operate at 20–30 K above the saturation temperature, where the saturation temperature of flue-gas is between 45 °C and 55 °C. Thus, most plants do not require the reheating of the clean flue-gas, unless the dew point can be reached, although the required stack temperature must still somehow be met. General performance and operational parameters of spray dry scrubbers are shown in Table 3.13.

The small amounts of SO₃ always present in boiler flue-gas are absorbed in a spray dry absorber. The alkaline calcium-based absorbent reacts with acidic SO₃/H₂SO₄ to form sulphuric salts. The SO₃/H₂SO₄ removal is normally completed effectively by the alkaline cake layer formed on the surface of bag filter bags, in addition to the common gas/solid neutralisation reactions.

Table 3.13: Performance of the spray dry scrubber technique for reducing sulphur oxide emissions

Technique	General SO ₂ reduction rate	Other performance parameters	
		Parameter	Value
Spray dry scrubber	85–92 %	Operating temperature	120–200 °C (flue-gas inlet) 65–80 °C (flue-gas outlet)
		Sorbent	Lime, calcium hydroxide
		Residence time	Approx. 10 s
		Ca/S molar ratio	1.1–1.4
		Max. flue-gas flow per absorber	3 300 000 m ³ /h
		Removal range of SO ₃ and HCl	95 % to > 99 %
		Recirculation rate of used sorbent	0–75 %
		Solid content in injected liquid	10–45 %
		Reliability	95–99 %
		Residue/by-product	Mixture of fly ash, unreacted additive and CaSO ₃
		Energy consumption as % of electric capacity	0.5–1 %
		Water consumption	20–40 l/1000 m ³ flue-gas (depends on gas temperature)
		Waste water	None
		Pressure drop of the spray dryer without the dedusting device	10 mbar (10 ³ Pa)

NB:
 The use of tower mills for slaking can increase the reactivity of the slaked lime.
 As spray dry scrubbers can remove more SO₃ than wet scrubbers, there is likely to be less of a problem of H₂SO₄ in the environment close to the plant than with wet scrubbers.
 The overall power consumption for pollution control (including NOX and dust control devices) is usually below 1.0 % in a plant using a spray dry scrubber.
 With sulphur contents exceeding 3 %, the removal efficiency decreases slightly.
 The spray dry scrubber efficiency very much depends on the dedusting device used (e.g. bag filter or ESP), because desulphurisation occurs to a certain extent, for instance, in the filter cake of the bag filter.

Cross-media effects

The residue is normally a mixture of the original sorbent, calcium sulphite, calcium sulphate and fly ash, which is less attractive commercially. Most SDA residues being produced around the world are used in the construction industry, in underground mining, for land reclamation purposes, as fertiliser or as a reagent in a synergy process with a wet FGD system.

A common means of disposal and utilisation of the spray dry scrubber residue are stabilised landfills. As the residue contains unreacted lime, it cannot be disposed of untreated, because it produces dust and there may be a risk of an uncontrolled leaching of hazardous components. Therefore, it is specially conditioned by mixing with water and fly ash to produce a disposable fixed product. The residue is both an advantage and disadvantage to the system. Establishing a use for the residue is a key aspect of the application of a spray dry scrubber. As it contains a large amount of unreacted lime, the product is used as a solvent for wet FGD systems sited nearby, providing the ash content is low enough. Research suggests a new field of application for the residue product is as an additive to fertilisers where sulphur is required.

An additional cross-media effect is the reduction of the combustion plant's energy efficiency.

Technical considerations relevant to applicability

The spray dry scrubber is suitable for low- to moderate-sulphur fuels and for use in smaller facilities. The equipment includes slurry preparation, handling and atomisation equipment, all of which have to be able to withstand erosion by the slurry. The dry solid by-product can be used in a range of different construction purposes.

Economics

Spray dry scrubbers are generally characterised by lower capital costs but have higher operating costs than wet scrubbers, mainly due to the use of the more expensive lime sorbent. Spray dry scrubbers are mostly used for relatively small to medium-sized capacity boilers using low- to medium-sulphur (1.5 %) coal. For the same reason, they are preferable for retrofits and for peak load operation.

The capital cost for the spray dry system mainly depends on the capacity of the plant and the type and layout of the spray dry absorber and the injection system. Reported capital costs differ significantly, depending on the type of power plant. The capital cost of a spray drying system is approximately 30–50 % less than the capital cost of a wet limestone process for an LCP of the same size, but the operating costs are higher due to the higher sorbent costs. The four to five times higher cost of the lime sorbent used in spray dry scrubbers, compared to limestone for the predominant wet scrubbers, is probably the greatest disadvantage of spray dry scrubbers. The use of a single-module spray dryer is limited to units below 1 500 MW_{th}, with a 3.3 million m³/h maximum flow rate, and to low- to moderate-sulphur fuels, in order to keep the operational costs within reasonable limits. Spray dry systems are only cheaper for smaller units and low operational loads.

Spray dry scrubber costs for a boiler have been estimated to be EUR 7–45 per kW_{th} (fuel energy input) in investment costs, and EUR 0.5–0.7 per MWh in operating and maintenance costs. The cost of the reduced pollutant was EUR 600–800 per tonne of sulphur dioxide removed. The effect on the price of electricity was approximately EUR 6 per MWh (electricity produced). Higher peak prices correspond to smaller LCPs in comparison to wet FGD applications. A larger diesel engine has an oxygen content of about 13–15 vol-% O₂ in the flue-gas (air factor 2.7–3.5); and a boiler plant typically 3–6 vol-% O₂ (air factor 1.2–1.4), depending on the fuel used. A higher oxygen content means a greater exhaust gas flow and the need for a greater FGD reactor system, which leads to a higher investment cost, etc.

Depending on the different possibilities for by-product utilisation, the by-product treatment and disposal costs have to be taken into account for the spray dry processes when comparing the costs of the different desulphurisation methods.

Driving force for implementation

A spray dry scrubber/absorber is a simple, reliable and efficient desulphurisation system with few control loops which is easy to control and which produces no waste water (zero liquid discharge).

Example plants

Plants 213, 376, 443-1/2, 462 and 489.

Reference literature

[16, GEA Niro 2012]

3.2.2.7 Circulating fluidised bed (CFB) dry scrubber

Description

The circulating fluidised bed (CFB) process is a separate process to the spray dry scrubber and the duct sorbent injection techniques. Flue-gas from the boiler air preheater enters the CFB absorber at the bottom and flows vertically upwards through a venturi section where a solid sorbent and water are injected separately into the flue-gas stream.

Technical description

The venturi is designed to achieve the proper flow distribution throughout the operating range of the vessel. Inside the venturi, the gas is first accelerated, and then decelerated before entering the cylindrical upper vessel. The height of the vessel is designed to accommodate the mass and residence time of bed material required for the desired Ca and SO₂ contact time. Sizing of the equipment is mostly determined depending on the flue-gas flow. All external inputs, such as the recirculating material, fresh reagent and gas-conditioning water, are introduced to the gas at the diverging wall of the venturi. The vessel has no internal mechanical or structural components. Control of the gas distribution, the sorbent flow rate, and the distribution and the amount of humidifying water ensures the appropriate conditions for optimum SO₂ removal efficiency.

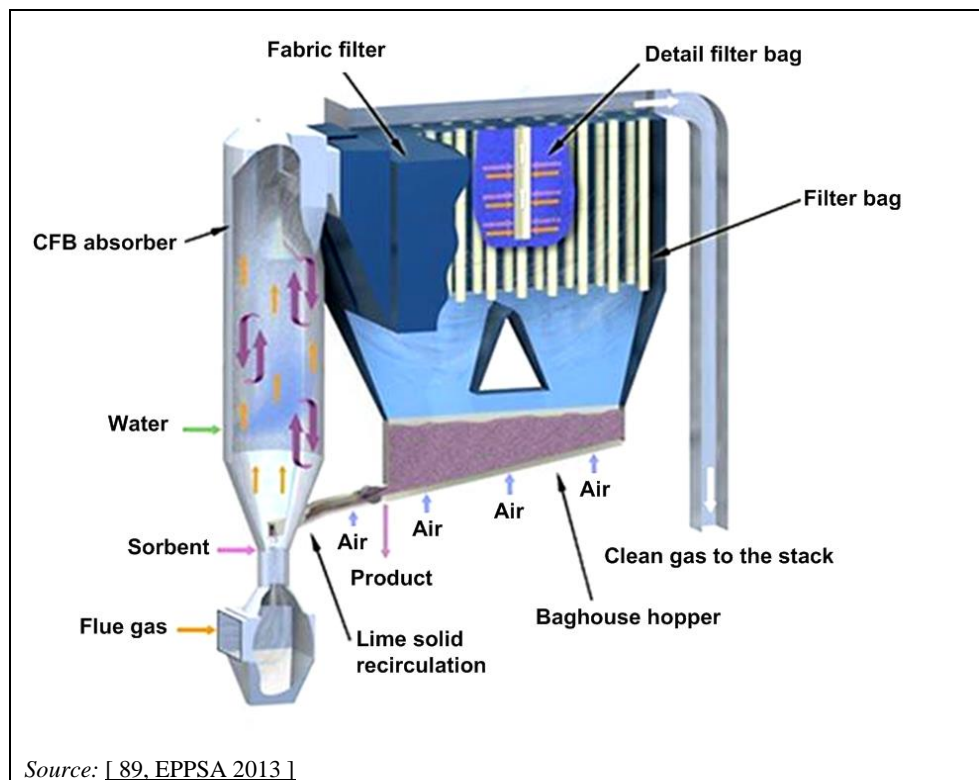
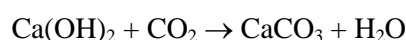
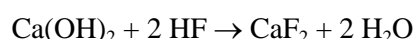
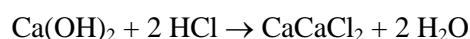
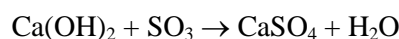
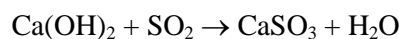

Figure 3.25: Schematic of a CFB scrubber process flow

The treated exhaust gas flows to a dust collector (bag filter or electrostatic precipitator), where dust is removed from the flue-gas. Outlet gases from the particulate collector are transported to a stack by means of an induced draft fan. The majority of the solids collected are recycled back to the absorber. The hopper level controls the extraction of powder to the by-product silo for disposal. [188, Alstom 2002]

The process chemistry associated with acid gas removal from the flue-gas is a simple acid/base absorption reaction between SO₂, HCl, HF and hydrated lime as follows:



The absorption chemistry is strongly affected by factors such as the flue-gas temperature, gas humidity and SO₂ concentration in the flue-gas. The by-product is a dry mixture of calcium sulphite, calcium sulphate, fly ash and unreacted lime.

The use of a pre-collector that removes most of the fly ash before it enters the absorber is a common design feature. It is installed between the air heater and the absorber. The installation of a pre-collector has some advantages that can help to balance its initial capital and operating costs, e.g.:

- For a given desulphurisation yield, it can reduce the lime consumption (at a given ΔT). Although this requires the CFB scrubber operating temperature to be increased (at a given Ca/S ratio), this also reduces dust deposition risks.
- It helps to achieve a greater ESP efficiency and, therefore, lower final emissions.
- It reduces the volume of waste for disposal.
- It collects a saleable product (fly ash), which is useful as the market for fly ash is well established.

The pre-collector is normally a simple one-field ESP. However, in retrofits the existing particulate control equipment is often used as a pre-collector.

The process is not complicated to operate and is easy to maintain because it does not require high-maintenance mechanical equipment such as grinding mills, abrasion-resistant slurry pumps, agitators, rotary atomisers, and sludge dewatering devices. Furthermore, the increased effective surface area of the circulating bed permits successful capture of virtually all of the SO₃ and halides in the gas, eliminating the possibility of gas path corrosion from condensate SO₃ aerosol mist.

Achieved environmental benefits

- Reduced SO_x and halides emissions to air.
- Increased dust removal efficiency.

Environmental performance and operational data

Table 3.14: Performance of the CFB dry scrubber technique for reducing sulphur oxide emissions

Technique	General SO ₂ reduction rate	Other performance parameters		Remarks
		Parameter	Value	
CFB dry scrubber	90–99 %	Halides reduction efficiency	95 % to > 99 %	The CFB vessel is designed with clean gas recirculation and an internal gas velocity range of 1.8–6 m/s for boiler loads from 30 % to 100 %. High removal of metals.
		Operating temperature	90 °C (+/-15 °C)	
		Residence time	3 s	
		Ca/S	1.1/1.5	
		Recirculation rate of used sorbent	10–100 %	
		Energy consumption	0.3–1 %	
		Sorbent	Ca(OH) ₂	
		Reliability	98–99.5 %	
		Pressure drop without dedusting	7–15 hPa	
Residue	CaSO ₃ /CaSO ₄ /fly ash			

Cross-media effects

- Marketing of the by-product is a challenge.
- Reduction of the combustion plant's energy efficiency.

Technical considerations relevant to applicability

- No information provided.

Economics

- Lower investment costs compared to other DeSO_x methods.
- Reactivation of fly ash can affect its saleability.
- Recirculation of product within the CFB system: a higher utilisation of the used sorbent allows savings in fresh sorbent consumption.
- An additional way to reduce operating costs is the use of a Lime Dry Hydration System (LDH): by using an on-site hydrator, cheaper lime reacts with water to a high-quality hydrated lime.
- Larger combustion plants can require multiple scrubbers.

Driving force for implementation

- Reduction of SO_x emissions.
- Simple, reliable and high removal efficiency.
- Low water consumption.
- No water/sludge to be treated.
- Inclusion of a dedusting step.
- High capture of halides and SO₃.

Example plants

Plant 189.

Reference literature

[190, EPPSA 2015] [191, EPPSA 2015]

3.2.2.2.8 Duct sorbent injection

Description

Dry powder is introduced and dispersed in the flue-gas stream. The material reacts with the gaseous sulphur species to form a solid, which has to be removed by filtration (bag filter or electrostatic precipitator).

Technical description

Duct sorbent injection (DSI) means the injection of a calcium- or sodium-based sorbent into the flue-gas, between the air heater and the ESP or bag filter, as shown in Figure 3.26.

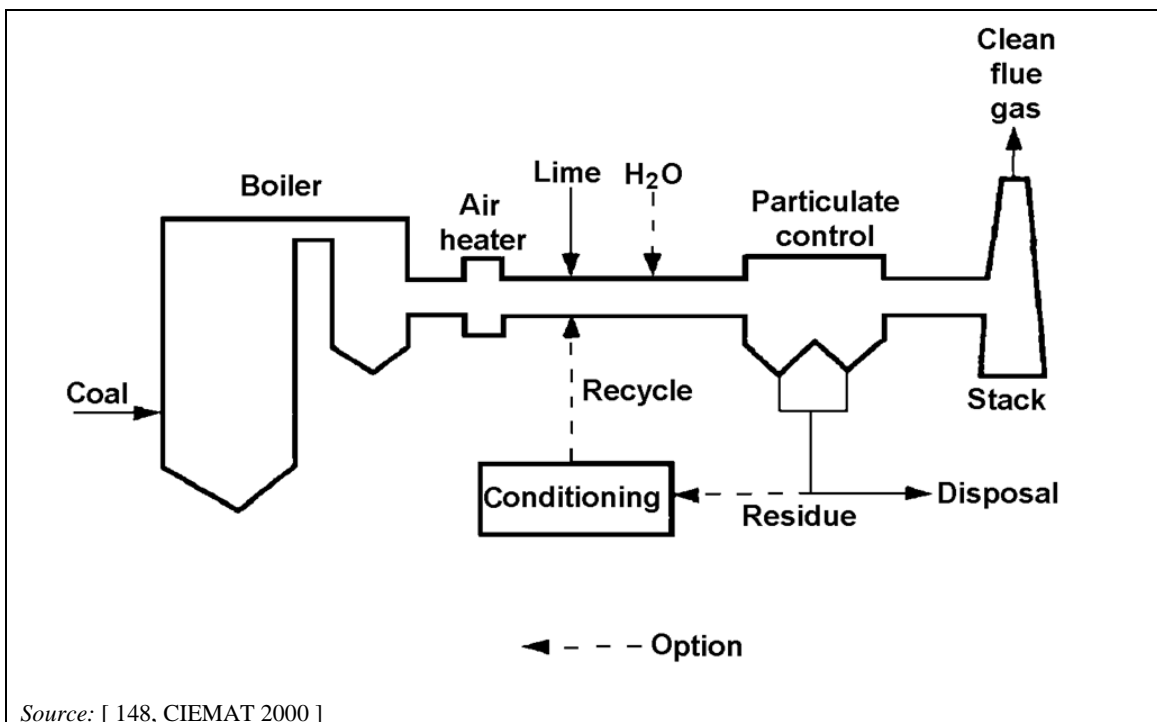

Source: [148, CIEMAT 2000]

Figure 3.26: Duct sorbent injection

The most common types of duct sorbent injection are:

- dry hydrated lime, for which the sulphur capture can be improved by humidification in some cases (depending on flue-gas composition);
- dry sodium bicarbonate injection, which does not require humidification but requires on-site milling for improved capture;
- lime slurry injection or in-duct scrubbing, which does not require a separate humidification step (also known as 'modified dry FGD' - see Figure 3.27).

The humidification water serves two purposes. First, it activates the sorbent to enhance SO₂ removal and, secondly, it conditions the dust to maintain an efficient ESP performance. However, when a bag filter is used, humidification needs to be carefully controlled in order to avoid wet deposits on the filtering media.

Even though duct sorbent injection is an outwardly simple process, two of the key phenomena to increase its control are a) the desulphurisation of flue-gas by calcium- or sodium-based sorbent in the recycling of product with a high amount of unreacted absorbent, and b) the coupling with an existing ESP to increase the efficiency, by reducing the temperature and by having a higher humidity. An additional parameter is to humidify the recycled products in such a way that the walls and ESP are not in direct contact with water, to avoid the risk of corrosion. Recently, lime slurries have been improved to enhance SO₃ and SO₂ absorption (e.g. by including additives (Mg and Na)).

The reaction between SO₂ and hydrated lime is described in Section 3.2.2.2.6. For increased reaction performance, special high-spec surface-hydrated lime can be used.

After injection, the sodium bicarbonate decomposes thermally to form sodium carbonate. Once the initial sorbent surface of the sodium carbonate has reacted with SO₂ to form sodium sulphite or sulphate, the reaction slows due to pore plugging (which resists the gas phase diffusion of SO₂). In order for the reaction to continue, the sorbent particles must decompose further. This decomposition transfers H₂O and CO₂ gases into the surrounding atmosphere, creating a network of void spaces throughout the particles. This process exposes fresh reactive sorbent and allows SO₂, once again, to diffuse into the particles' interior. This increase in surface area is in the order of 5–20 times the original surface area, depending on the specific sorbent considered. The following series of reactions are thought to take place to produce sodium carbonate for the removal of SO₂:

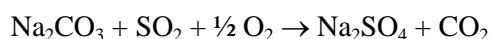
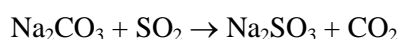

The rates of decomposition and subsequent sulphation of the sodium compound particles are a complex function of flue-gas temperature, rate of heat transfer to the particles, flue-gas H₂O and CO₂ content, partial pressures, and the effects of other flue-gas components present.

The duct sorbent injection process is very simple and is easy to operate, so there are no major risks of process malfunction.

The process is suitable for various fuels and combustion techniques, especially when the injection is into the cooler part of the duct. It is possible to avoid sorbent sintering and/or melting when the sorbent is supplied to the colder part of the flue-gas duct.

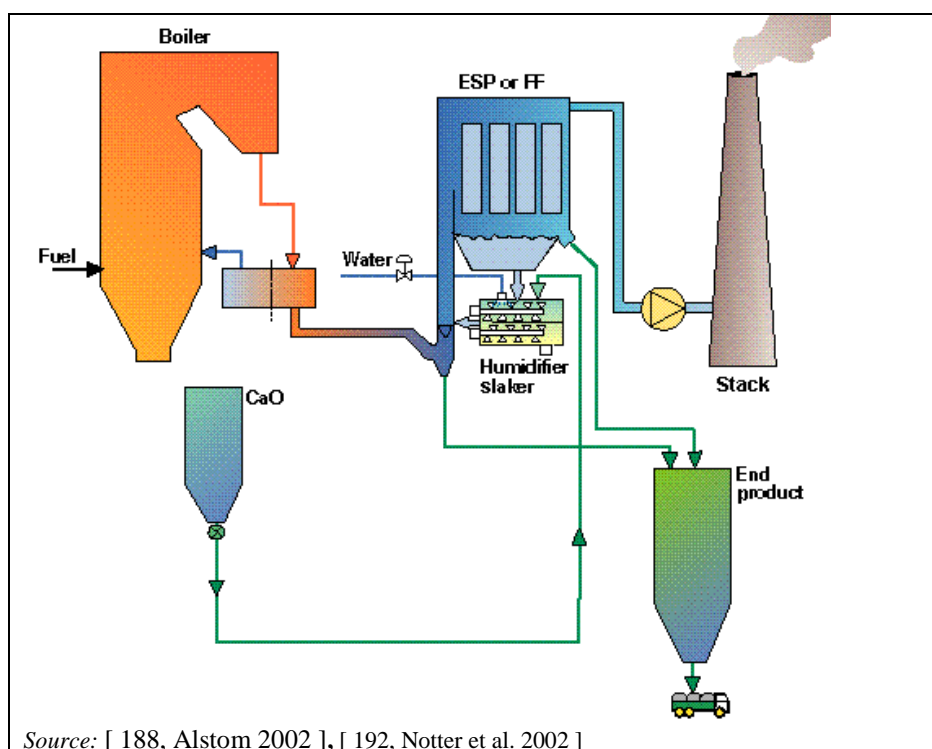

Figure 3.27: 'Modified dry FGD' process

Achieved environmental benefits

Reduced SO_x and halide emissions to air.

Environmental performance and operational data

Table 3.15: Performance of the duct sorbent injection technique for reducing sulphur oxide emissions

Technique	General SO ₂ reduction rate	Other performance parameters		Remarks	
		Parameter	Value		
Duct sorbent injection (dry FGD)	50–80 %	Operating temperature	NA	Low capital costs and extremely simple installation.	
		Sorbent	Limestone, hydrated lime, dolomite		Easy to retrofit (small space and short construction period).
		Reliability	99.9 %	No waste water.	
		Energy consumption as % of electric capacity	0.2 %		Ash handling is more difficult because the ash is enriched with unreacted lime, which causes the ash to harden after wetting.
		Residue	Ca or Na salt mixture		
				Reliability can be affected by nozzle plugging and material deposit inside ducts, resulting in unplanned outages.	
NB: NA: Not available.					

The target for SO₂ removal efficiency in duct sorbent injection used to be, generally, at least 50 %. Newer processes aim to achieve 70–95 % SO₂ removal efficiency without appreciable additional capital costs or operational difficulties, the improvements being based on a better understanding of the duct sorbent injection process. Because the process is very easy to control, changes in the boiler load or in other parameters do not affect the SO₂ removal efficiency.

SO₂ removal efficiencies with sodium bicarbonate are generally higher than with hydrated lime. However, sodium bicarbonate must generally be milled to a very fine size prior to injection, in order to achieve good utilisation of the sorbent. Milling is usually done immediately before injection, but in some cases the use of pre-milled bicarbonate is also possible.

Spent sorbent recycling is especially important in the economics of duct sorbent injection, because shorter sorbent residence times (0.5–3.0 seconds) have led to lower sorbent utilisation, compared to conventional spray dry scrubbers. Only 15–30 wt-% of Ca(OH)₂ usually reacts with SO₂, except in the case of spent sorbent recycling. This means that 70–85 % of the unreacted Ca(OH)₂ collected in the ESP is disposed of with the dry fly ash or reused (compounds of CaSO₄). Low sorbent utilisation is a disadvantage in duct sorbent injection processes. Spent sorbent recycling has been adopted in many processes to improve sorbent utilisation and to enhance the SO₂ removal performance.

Cross-media effects

The by-product cannot always be reused (e.g. Na₂SO₄ leachates in water), which means the need for a special infrastructure for intermediate/final disposal/treatment. The use of high-spec surface-hydrated lime increases sorbent utilisation and may reduce or eliminate the need for sorbent recycling. With sodium bicarbonate, sorbent utilisation of more than 80–90 % is common.

Reduction of the combustion plant's energy efficiency is another cross-media effect.

Technical considerations relevant to applicability

Duct sorbent injection has great potential for relatively old and small boilers.

Economics

The characteristics of duct sorbent injection technologies are low capital costs, the simplicity of the process, and their adaptability to difficult retrofit situations. However, they have a relatively low SO₂ removal efficiency. They are economically competitive at small power plants.

In a sorbent recycling system, a portion of the collected solids can be recycled back to the duct to provide another opportunity for the Ca(OH)₂ to react with SO₂. Recycling these solids increases the total Ca(OH)₂ content in the system without increasing the rate of fresh hydrated lime addition. Therefore, any increase in SO₂ removal is achieved without increasing fresh sorbent costs.

The required reactants are more expensive than in the limestone processes, such as in in-furnace injection. The cost of both sodium bicarbonate and high-spec surface-hydrated lime is usually higher than that of ordinary hydrated lime. This means that the operating costs tend to be higher, even though a smaller Ca/S molar ratio is possible.

The reduction rate of the process can be improved by increasing the Ca/S ratio, which means increased sorbent costs and auxiliary power demand. With sodium bicarbonate and high-spec surface-hydrated lime sorbent utilisation, the reduction efficiency is however markedly higher and the resulting residue quantities are lower. Lower sorbent consumption and reduced disposal costs may offset the higher cost of the sorbent.

The by-product cannot always be reused, which causes more expenses to the operator.

Driving force for implementation

- Reduction of SO_x emissions.
- Low investment and operational costs, low energy consumption, and a stable process.
- No emissions to water from waste water treatment.
- Higher SO_x removal efficiency than in-bed sorbent injection for bubbling fluidised bed boilers.

Example plants

Plant 125 (modified dry FGD).

Plants 69 and 168 (pilot DSI) combine a DSI with an ESP.

More example plants combining a DSI and a bag filter can be found in the graphs representing well-performing plants in the fuel-specific sections.

Reference literature

[61, Commission 2006] [18, CaO Hellas - GREECE 2011]

3.2.2.2.9 Use of sorbents in fluidised bed combustion systems

Description

Sorbents in fluidised bed combustion (FBC) systems are integrated desulphurisation systems where sulphur reacts with the alkaline calcium or magnesium compounds injected into the bed.

Technical description

The burning temperature in a FBC system is favourable for sulphur to react with the calcium or magnesium compounds added into the bed. This limits the combustion temperature to about 850–870 °C. The sorbent utilised is typically CaCO₃-based limestone. The reaction needs a surplus of sorbent with a stoichiometric ratio (fuel/adsorbent) of 1.5 to 7, depending on the fuel. The sorbent is supplied into the combustion chamber constantly. Its quantity depends on many factors such as the amount of sulphur in the fuel, the temperature of the boiler bed and the physical and chemical characteristics of the limestone sand. The ideal temperature range for the reaction is between 840 °C and 900 °C. The reaction products, calcium sulphate and unreacted limestone, are removed, partly from the bed together with bed ash and partly from the electrostatic precipitator or bag filter together with the fly ash. Higher Ca/S ratios are needed in fluidised bed combustion than in wet scrubbing or spray towers for a high reduction of sulphur. Higher degrees of desulphurisation are achieved in circulating fluidised bed combustion (CFBC) boilers than in bubbling fluidised bed combustion (BFBC) boilers.

Achieved environmental benefits

Reduced SO_x emissions to air.

Environmental performance and operational data

Even with very high Ca/S ratios, FBC cannot achieve as high reduction rates as wet scrubbing.

For coal and lignite, removal efficiencies as high as 80–95 % are possible in CFBC boilers with moderate Ca/S ratios (i.e. between 1.5 and 3). When the fuel sulphur content increases, the Ca/S ratio decreases slightly for a certain sulphur removal (e.g. 90 % removal). However, the actual mass flow rate of limestone needed increases, as well as the amount of residues generated. Hence, the current trend for CFBC boilers firing high-sulphur (4–6 % S) fuels is to combine a) *in situ* sulphur capture by limestone in the furnace, and b) cold-end sulphur capture.

In BFBC boilers, the corresponding removal efficiency is between 55 % and 65 %, with a similar quality of coal or lignite and with a similar quality and consumption of limestone. In BFBC boilers burning only coal, additional end-of-pipe techniques are needed.

The in-furnace desulphurisation rate is voluntarily limited when combusting high-chlorine fuels, in order to maintain the favourable effect the remaining SO₂ in the flue-gas has on mitigating the corrosion in the boiler backpass.

Cross-media effects

- Increase in limestone sand consumption.
- Increase in generated waste (desulphurisation products are contained in bottom ash and fly ash).
- Increase in electricity consumption and reduction of the combustion plant's energy efficiency.

Technical considerations relevant to applicability

The presence of lime/limestone in the bed changes the bed composition and the softening temperature. It is thus critical to fix the injection level according to the bed's operating parameters to avoid issues with its behaviour.

For high-sulphur fuel, when this technique is not sufficient to reach the targeted SO_x emission level, downstream polishing FGD can be installed, typically duct sorbent injection or the circulating fluidised bed process.

Economics

Use of this technique is limited to fluidised bed boilers but it represents an *in situ* FGD process without significant investment.

Limestone sorbent is cheap but this technique requires a higher dosage than a wet scrubbing system. In an example 1 GW_{th} CFB coal-fired boiler, the cost of sorbent for a removal efficiency of 93 % was about EUR 0.25 per MW_{th} (fuel energy input) in 2011.

Driving force for implementation

- Reduction of SO_x emissions.
- Low construction costs.
- Lack of waste water from the system.

Example plants

This technique is commonly used throughout Europe for reducing SO_x emissions. See Plants: coke-/coal-/lignite-firing plants: 489-1/2, 387, 19, 81, 390-1/5, 224, 156, 377 (all CFB boilers) and 69 (BFB boiler); and peat-/biomass-/waste-firing plants: 42, 190, 539 (CFB boilers) and 188 (BFB boiler).

Reference literature

[193, Wilhelm et al. 2011]

3.2.2.2.10 Furnace sorbent injection in pulverised combustion boilers

Description

Furnace sorbent injection consists of the direct injection of a dry sorbent into the gas stream of the boiler furnace. The surface of these particles reacts with the SO₂ in the flue-gas.

Technical description

Typical sorbents include pulverised limestone (CaCO₃) and dolomite (CaCO₃·MgCO₃). If the reagent is injected into the economiser area, hydrated lime is typically used. In the furnace, the heat results in the calcination of the sorbent to produce reactive CaO particles. The surface of these particles reacts with the SO₂ in the flue-gas to form calcium sulphite (CaSO₃) and calcium

sulphate (CaSO_4) (see Figure 3.28). These reaction products are then captured along with the fly ash by the dust control device, typically an ESP or bag filter. The SO_2 capture process continues into the precipitator and into the filter cake of the bag filter. Using a bag filter is preferable because the reaction can continue with the unreacted sorbent deposited on the filter media. When an ESP is used, it may be preferable to inject the sorbent into a reactor to guarantee a sufficient contact time of a few seconds between the sorbent and the waste gas before the ESP. Due to its ability to work at relatively high temperatures and to its very high efficiency with regard to SO_2 abatement, the dry sodium bicarbonate process may be used upstream of an SCR system, without reheating the flue-gas before it enters the SCR system. This creates energy and cost savings which may be significant.

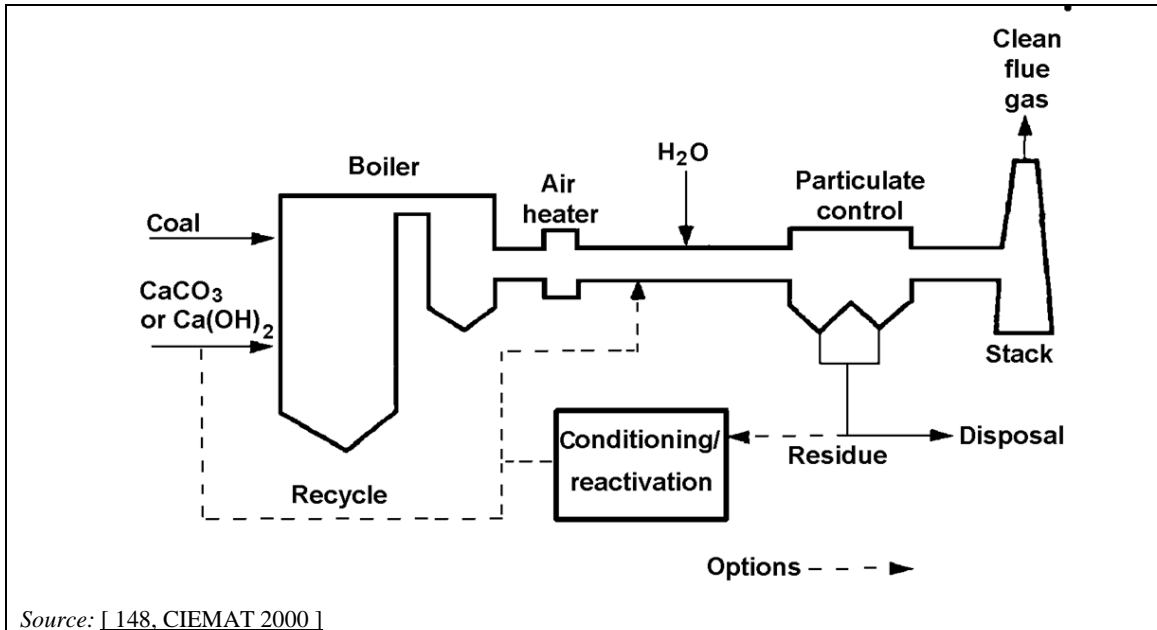
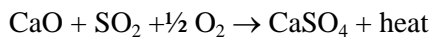
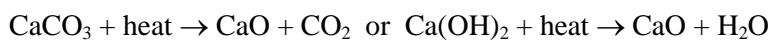

Figure 3.28: Furnace sorbent injection

The SO_2 removal occurs in the following two steps, as illustrated in Figure 3.29:



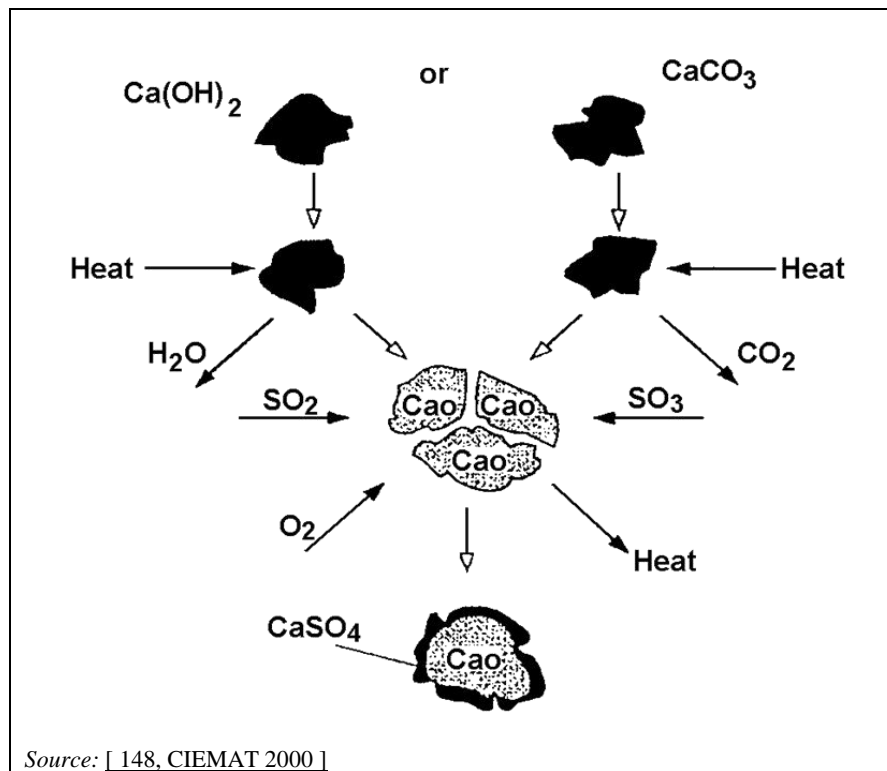

Figure 3.29: SO₂ removal reactions in furnace sorbent injection

Furnace sorbent injection provides the added benefit of removing SO₃.

The critical temperature range for the limestone reaction in furnace sorbent injection is 980–1 230 °C. Once a reactive lime (CaO) is produced, it must have sufficient time (at least half a second) in the critical temperature range. Hydrated lime has two reaction windows: 980–1 230 °C and around 540 °C. As a consequence, it is possible to use hydrated lime as reagent injected into the economiser region.

Thermochemically, CaSO₄ is not stable at temperatures above 1 260 °C in an environment typical of high-sulphur fossil-fuel-fired combustion products, e.g. 2 000–4 000 ppm SO₂ for firing coal. The lower temperature limit for the formation of CaSO₄ depends on complex interactions between sulphation kinetics, crystal growth and sintering, and the build-up of a barrier layer of CaSO₄ on the surface of the reactive CaO.

Achieved environmental benefits

Reduced SO_x emissions to air.

Environmental performance and operational data

Table 3.16: Performance of the furnace sorbent injection technique for reducing sulphur oxide emissions

Technique	General SO ₂ reduction rate	Other performance parameters	
		Parameter	Value
Furnace sorbent injection	30–50 % 70–80 % by recycling the reaction product	Operating temperature	98–1 230 °C (upper furnace) 540°C (economiser)
		Sorbent	Limestone, hydrated lime, dolomite
		Reliability	99.9 %
		Boiler efficiency drop	2 %
		Energy consumption as % of electric capacity	0.01–0.2 %
		Residue	Ca salt mixture

The efficiency of SO₂ control is primarily a function of the Ca/S molar ratio, the sorbent type, the degree of humidification, the additives available, the injection point and the boiler load.

The SO_x removal efficiency and limestone utilisation efficiency are lower than with other FGD systems. There are several measures to improve SO_x removal efficiency at a low capital cost, for instance by adding some devices to the furnace sorbent injection unit. The simplest measure is to spray water into the duct before the precipitator. This results in an improvement in the SO_x removal efficiency of about 10 %. Furthermore, in order to make better use of the lime generated in the furnace area, it is possible to design an additional absorber (e.g. CFB scrubber) where the excess reagent will have a long enough residence time to further react with the flue-gas stream. In this case, the total efficiency of the SO₂ removal can reach 98 % (see Section 3.2.2.2.7).

Recycling the reaction product is an effective alternative and has been investigated in order to improve the efficiency of both SO₂ reduction and limestone utilisation. The reaction product collected by the particulate control device (ESP or bag filter) is reinjected into the furnace or duct and circulated several times. In some processes, it is recycled after conditioning. These measures are expected to achieve 70–80 % SO₂ removal efficiency.

Cross-media effects

The residues are disposed of, for example, as landfill, although careful control is needed because they include active lime and calcium sulphite. Possible utilisation of these residues is under investigation.

Ash handling and disposal are complications in furnace sorbent injection, mostly due to the sheer quantity of the reaction products to be processed. Operating at a Ca/S molar ratio of 2.0 with coal with an ash content of 10 % almost triples the rate at which the ash must be collected by the particulate control device and then transferred to the ash disposal site. Some retrofitted plants require improvements to the ESP to accommodate such amounts.

Although many research projects are in progress to utilise the reaction product, most utilities equipping a furnace with sorbent injection must have a specially prepared disposal site, in contrast to wet scrubbers which produce a saleable by-product, i.e. gypsum.

The process itself is relatively simple and therefore requires less operation and maintenance. The process produces a dry solid residue, which needs no further treatment before being discharged to a landfill or being used as a construction material.

Furnace sorbent injection can cause slagging and fouling of heat exchangers, so soot blowing may have to be increased.

Furnace sorbent injection can increase the amount of unburnt carbon-in-ash and reduce the combustion plant's energy efficiency.

Technical considerations relevant to applicability

The process is suitable for low-sulphur fuels and for use in small plants.

Economics

Capital costs for the furnace sorbent injection processes in power generation are lower than for the spray dry system and the wet scrubber. One benefit of this simple process is that no extra staff are needed to operate or maintain the process. Reuse of the by-product is possible, but it has no economic value.

Driving force for implementation

- Reduction of SO_x emissions.
- This technique is well suited to older and small power plants where available investment/space is limited.

Example plants

In China, this process has proven to be suitable due to the moderate SO₂ emission requirements, the local coal's sulphur content, and the simplicity of the process.

Reference literature

No information provided.

3.2.2.2.11 Hybrid sorbent injection

Description

Hybrid sorbent injection is a combination of furnace sorbent injection and duct sorbent injection to improve SO₂ removal efficiency.

Technical description

A feature of hybrid sorbent injection is the application of limestone as a sorbent in the furnace and hydrated lime as a sorbent for the duct sorbent injection, as described in Sections 3.2.2.2.10 and 3.2.2.2.8. Some hybrid sorbent injection processes have reached commercial status because of the following main operational features:

- relatively high SO₂ removal rate (not achievable with only furnace or duct injection);
- easy to retrofit;
- easy operation and maintenance, with no slurry handling;
- reduced installation area due to compact size of equipment;
- no waste water treatment needed.

Achieved environmental benefits

Reduced SO_x and halide emissions to air.

Environmental performance and operational data

Table 3.17: Performance of the hybrid sorbent injection technique for reducing sulphur oxide emissions

Technique	General SO ₂ reduction rate	Other performance parameters		Remarks
		Parameter	Value	
Hybrid sorbent injection	70–95 %	Residence time	3 s	Used in some plants in the US

Cross-media effects

- Influence of free lime on the combustion product (as described in Section 3.2.2.2.9 in the case of non-recirculation).
- Reduction of the combustion plant's energy efficiency.

Technical considerations relevant to applicability

This technique has great potential for older and smaller boilers to improve the reliability and efficiency of SO_x removal without appreciable additional capital costs or operational difficulties, the improvements being based on a better understanding of the duct sorbent injection process and spent sorbent recycling.

Economics

Limestone is cheaper than lime, which is generally used in spray dry scrubbers. The technique is associated with low capital and operational costs.

Driving force for implementation

- Reduction of SO_x emissions.
- No waste water generated.

Example plants

No information provided.

Reference literature

No information provided.

3.2.2.2.12 Magnesium oxide process

Description

The magnesium oxide process is a regenerable wet scrubbing process, which uses magnesium hydroxide solution as sorbent.

Technical description

The technique is essentially the same as for the limestone wet scrubber except for the regeneration step for the spent sorbent. HCl and HF in the flue-gas are removed in a pre-scrubber, to avoid contamination of the magnesium salt after SO₂ absorption. The flue-gas then enters the scrubber, where the SO₂ is absorbed by aqueous slurry of magnesium sulphate, formed from the magnesium hydroxide sorbent:

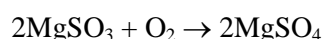
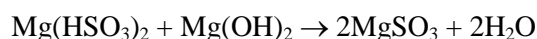
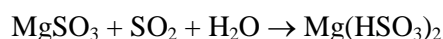

The reaction product, magnesium sulphite/sulphate, is bled continuously from the absorber and dried in a dryer. The magnesium sulphite/sulphate is calcined at about 900 °C in the presence of carbon, to regenerate magnesium oxide which is returned to the absorption system:

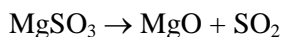

As a by-product, elemental sulphur, sulphuric acid or concentrated sulphur dioxide is obtained in the process. These are saleable by-products, which can be sold to reduce overall operating costs. Otherwise, regeneration of the magnesium oxide would require a large amount of thermal energy.

Achieved environmental benefits

Reduced SO_x emissions to air.

Environmental performance and operational data

No information provided.

Cross-media effects

No information provided.

Technical considerations relevant to applicability

No information provided.

Economics

No information provided.

Driving force for implementation

Reduction of SO_x emissions.

Example plants

No information provided.

Reference literature

No information provided.

3.2.2.3 Techniques to prevent and/or reduce NO_x emissions

3.2.2.3.1 Low excess air firing

Description

Reduction of the amount of oxygen available in the combustion zone to the minimum amount needed for complete combustion and for minimising NO_x generation. The technique is mainly based on the minimisation of air leakages in the furnace, careful control of the air used for combustion and a modified design of the furnace combustion chamber.

Technical description

Low excess air is a comparatively simple and easy-to-implement operational measure for the reduction of nitrogen oxides emissions. By reducing the amount of oxygen available in the combustion zone to the minimum amount needed for complete combustion, fuel-bound nitrogen conversion and, to a lesser extent, thermal NO_x formation are reduced. A considerable emission reduction can be achieved with this technique, therefore it has been applied in many existing large combustion installations. In general, new plants are equipped with extensive measuring and control equipment that enables optimum adjustment of the combustion air supply.

No additional energy is required for low excess air firing (in fact less energy may be required as air and flue-gas flows are reduced, which reduces fan power consumption and flue-gas heat loss). If operated properly, no reduction in the availability of the power plant should result from this primary emission reduction measure.

Another effect of this technique is that not only will NO_x be reduced, but also SO₃, which can cause corrosion and fouling in the air preheater and the particulate control device.

Achieved environmental benefit

Reduced NO_x, N₂O and SO₃ emissions to air.

Environmental performance and operational data

The general NO_x reduction rate is 10–44 %. NO_x reduction strongly depends on the emission level of the uncontrolled plant.

For existing old coal-fired boilers that have applied ‘low excess air’ as a primary measure, the usual excess air is in the range of 5–7 % O₂ (in the flue-gas). Newbuild low excess air combustion systems are characterised by 3–4 % O₂ (in the flue-gas). Also, residence time has been identified as a key factor in the simultaneous control of NO_x, CO and unburnt carbon. The relationship between NO_x, CO and excess air at various sections in a 150 MW_e boiler is shown in Figure 3.30.

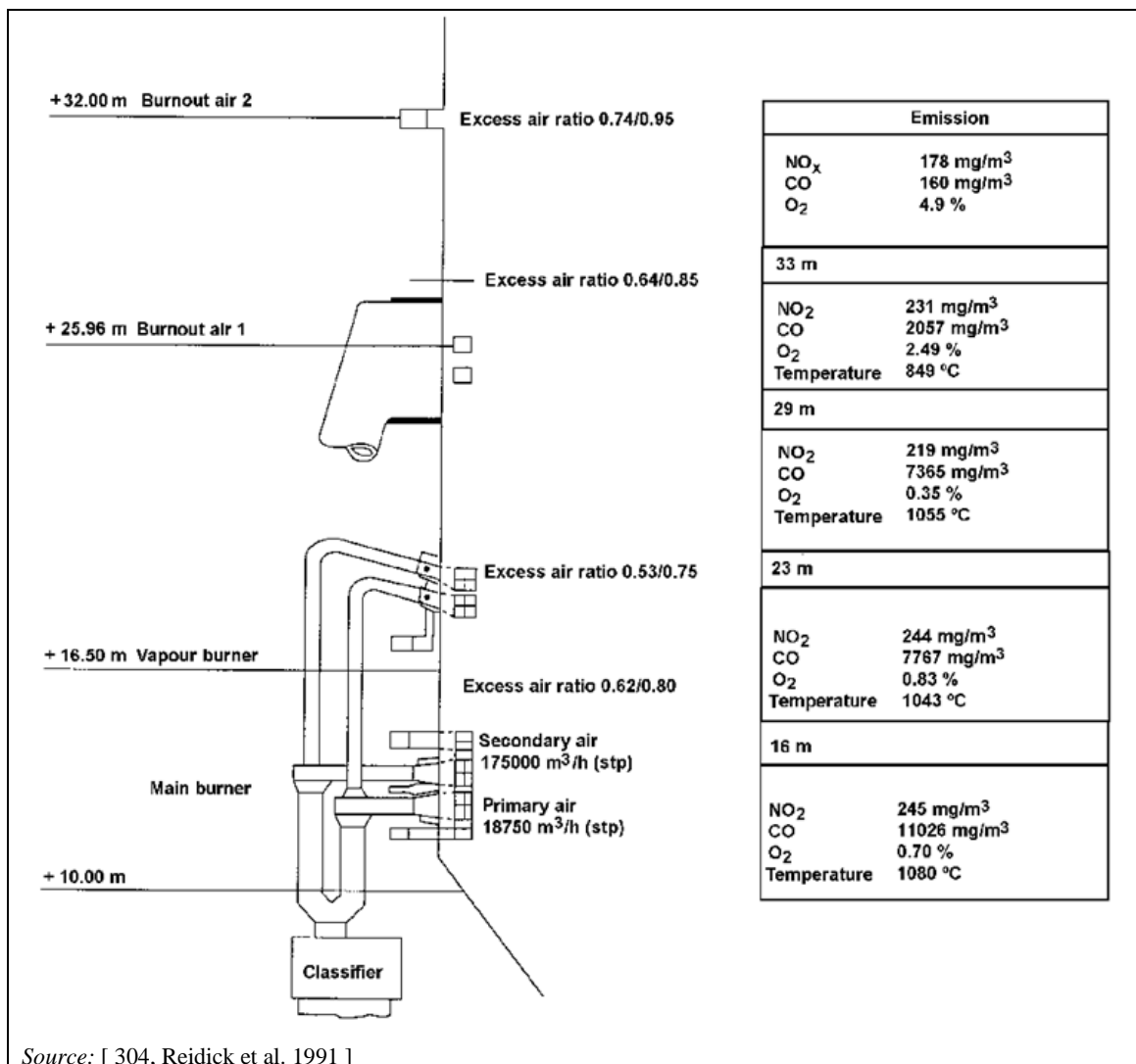

Source: [304, Reidick et al. 1991]

Figure 3.30: The relationship between NO_x, CO and excess air at various sections in a 150 MW_e lignite-fired boiler

Cross-media effects

As the oxygen level is reduced, combustion may become incomplete and the amount of unburnt carbon-in-ash may increase.

Reducing the oxygen in the primary zones to very low amounts can also lead to high levels of carbon monoxide. The result of these changes can be a reduction in the combustion plant's efficiency, as well as slagging, corrosion and an overall adverse impact on the combustion plant's performance.

These cross-media effects are usually overcome by implementing some form of overfire air system as shown in Figure 3.30.

An additional cross-media effect is that the steam temperature may decrease.

Potential safety problems, which might result from the use of this technique without a strict control system, include fires in air preheaters and ash hoppers, as well as increases in opacity and in the rates of water-wall wastage.

Applicability considerations

Generally applicable to new and existing boilers, for all fuels.

Economics

This is a very inexpensive way of decreasing nitrogen oxide emissions.

Driving force for implementation

Reduction of NO_x emissions.

Example plants

Plants 102 and 444.

Reference literature

No information provided.

3.2.2.3.2 Air staging**Description**

Creation of several combustion zones in the combustion chamber with different oxygen contents for reducing controlling NO_x emissions and for ensuring an optimised complete combustion.

Technical description

NO_x reduction by air staging is based on the creation of at least two divided combustion zones, a primary combustion zone with a lack of oxygen and a secondary combustion zone with excess oxygen in order to ensure complete burnout. Air staging reduces the amount of available oxygen in the primary combustion zone as only part of the combustion air (the primary air) is supplied to this zone. Primary air typically makes up 70–90 % of the total airflow for coal-fired boilers and 40–60 % for biomass boilers. The substoichiometric conditions in the primary zone suppress the conversion of fuel-bound nitrogen into NO_x. Also, the formation of thermal NO_x is reduced to some extent by the resulting lower peak temperature. In the secondary zone, 10–30 % (40–60 % in the case of biomass boilers) of the combustion air is injected above the combustion zone. Combustion is completed at this increased flame volume. Hence, the relatively low-temperature secondary stage limits the production of thermal NO_x.

In boilers and furnaces, the following options exist for achieving air staging:

- **Biased burner firing (BBF):** Biased burner firing is frequently used as a retrofit measure at existing installations (only for vertical boilers), as it does not require a major alteration

of the combustion installation. The lower burners operate with excess fuel whereas upper burners are supplied with excess air.

- **Burners out of service (BOOS):** Since putting some burners out of service does not require a major alteration of the combustion installation, this measure is frequently used as a retrofit measure at existing vertical boilers. Here, the lower burners are operated under fuel-rich conditions, whereas the upper burners are not in use, injecting only air. The effect of this measure is similar to overfire air, but NO_x emission reduction by BOOS is not as efficient. Problems may arise with maintaining the fuel input because the same amount of thermal energy has to be supplied to the furnace with fewer burners in operation. Therefore, this measure is generally restricted to gas- or oil-fired combustion processes.
- **Overfire air (OFA):** For overfire air operation, air ports (windboxes) are installed in addition to the existing burners. A part of the combustion air is injected through these separate ports, which are located above the top row of burners. Burners can then be operated with low excess air, which inhibits NO_x formation, the overfire air ensuring complete burnout. Typically 15–30 % of the total combustion air that would normally pass through the burners is diverted to overfire air ports. Retrofitting overfire air to an existing boiler involves applying water-wall tube modifications to create the ports for the secondary air nozzles and the addition of ducts, dampers and the windboxes.
- **Boosted OFA** systems such as high-pressure or multi-direction injection systems enhance the effect of OFA by preventing the formation of stratified laminar flow and enabling the entire furnace volume to be used more effectively for the combustion process. An example of the NO_x formation using a boosted OFA system is shown in Figure 3.31. The turbulent air injection and mixing provided by such systems allows for the effective mixing of chemical reagents (e.g. for SO_x removal or additional NO_x removal) with the combustion products in the furnace. By reducing the maximum temperature of the combustion zone and increasing the heat transfer, it may also improve the boiler's efficiency by one to two percentage points. Particulate residence time is also increased, thus reducing the carbon content in the fly ash and in the bottom ash. [19, EEB 2012] [20, COOMBS et al. 2004]

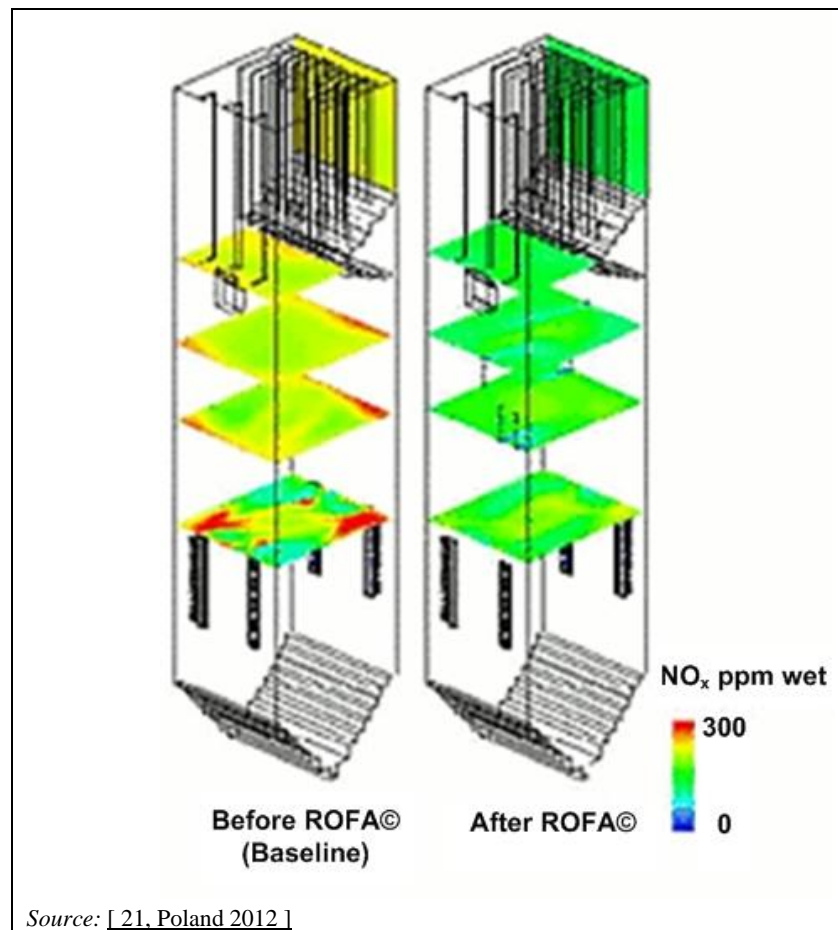

Figure 3.31: NO_x formation in a tangentially coal-fired boiler (with and without a rotating opposed fired air (ROFA) system)

Air staging in the furnace does not increase the energy consumption of the combustion plant, except when using boosted OFA systems (e.g. due to additional BOFA fans). It should also be noted that, by increasing the air mixing, air staging may also improve the plant's energy efficiency.

For fluidised bed combustion, the combustion starts in substoichiometric conditions by pyrolysis in the bubbling bed or in the bubbling-bed-type lower part of the circulating bed. The rest of the combustion air is added later, in stages, to finally achieve the over-stoichiometric conditions and to complete combustion. In circulating fluidised beds, the circulating bed material ensures an even temperature distribution that typically keeps the furnace temperature below $900\text{ }^\circ\text{C}$, which prevents, to a large extent, the formation of thermal NO_x . On the other hand, low temperatures promote the generation of N_2O and increase the amount of unburnt carbon.

Achieved environmental benefits

- Reduced NO_x emissions (see performance in Table 3.18).
- Increased efficiency for boosted OFA systems.

Environmental performance and operational data

Table 3.18: Performance of the air staging technique for reducing nitrogen oxide emissions

Primary technique		General NO _x reduction rate*	General applicability	Remarks	
Air staging	Burner out of service (BOOS)	10–70 %	Generally restricted to gas- and oil-fired plants for retrofit only	Incomplete burnout (and thus higher CO and unburnt carbon levels) may be experienced when retrofitting existing installations with BOOS, BBS or OFA techniques	Problems may arise with regards to maintaining the fuel input, because the same amount of thermal energy has to be supplied to the furnace with fewer burners in operation.
	Biased burner firing (BBF)		All fuels, for retrofit only		
	Overfire air (OFA) and Boosted overfire air (BOFA)		All fuels		Retrofitting OFA in an existing boiler involves water-wall tube modifications to create the ports for the secondary air. A NO _x reduction of 10–40 % is possible for wall-fired furnaces using OFA. A NO _x reduction of > 60 % is possible for BOFA at full load, and 50 % at low load.
<p>NB: The NO_x reduction potential is very dependent on the NO_x generation level and on a number of site-specific factors. If different primary measures to reduce NO_x emissions are combined the reduction rate can, in general, not be added or multiplied. The combined reduction rate depends on a number of site-specific factors and is validated on a plant-by-plant basis. Source: [19, EEB 2012] [20, COOMBS et al. 2004]</p>					

Cross-media effects

There are two major potential drawbacks of retrofitting air staging at existing plants. The first one is the usually significant amount of CO that may be formed if the air nozzles are not well situated, with the associated risk of corrosion in areas of the combustion chamber / burner zone, due to low air / high CO. The other is that the amount of unburnt carbon may increase, due to a volume decrease between the end of the combustion zone and the first heat exchanger. These drawbacks are limited in the case of boosted OFA systems, which enable intensive internal recirculation of flue-gases between the different combustion zones.

Correctly designed OFA in new boilers will not result in high CO or high unburnt carbon.
[21, Poland 2012]

Air staging in the furnace may also increase the energy consumption of the combustion plant in the case of boosted OFA which typically requires dedicated booster fans with the consequent related power consumption.

Technical considerations relevant to applicability

The furnace height in old boilers is usually low and may prevent the installation of overfire air (OFA) ports. Even if there is room for an OFA port, the residence time of the combustion gases in the upper part of the furnace may not be long enough for complete combustion. Applying air staging may thus require a reduction in unit capacity to allow the space for air staging. In boilers built later when more was known about NO_x formation, the furnace is usually larger and lower NO_x levels can thus be achieved. The best results are obtained when low-NO_x combustion is integrated into the boiler design.

Air staging is not applicable in gas turbines when there is not enough room for implementation.

Economics

This is a very inexpensive way of decreasing nitrogen oxide emissions. It is very often applied with other primary measures such as low-NO_x burners, so it is quite difficult to estimate the cost effects of the air staging element alone. A rough estimate is that OFA costs are almost EUR 1 million for a 250 MW_{th} boiler, and the NO_x reduction cost per tonne is typically EUR 300–1 000. [132, Rentz et al. 1999]

Driving force for implementation

Reduction of NO_x emissions.

Example plants

About 160 plants that submitted a questionnaire in 2012 for the review of this document are fitted with air staging.

See sections on coal, lignite and gaseous fuel combustion for further examples.

Reference literature

No information provided.

3.2.2.3.3 Flue-gas recirculation (FGR) or exhaust gas recirculation (EGR)**Description**

Recirculation of part of the flue-gas to the combustion chamber to replace part of the fresh combustion air, having the double effect of cooling the flame temperature and limiting the O₂ content for nitrogen oxidation, thus limiting the NO_x generation. It implies the supply of flue-gas from the furnace into the flame to reduce the oxygen content and therefore the temperature of the flame. The use of special burners or other provisions is based on the internal recirculation of combustion gases which cool the root of the flames and reduce the oxygen content in the hottest part of the flames.

Technical description

The recirculation of flue-gas results in the reduction of available oxygen in the combustion zone and, as it directly cools the flame, in the decrease of the flame temperature: therefore, both fuel-bound nitrogen conversion and thermal NO_x formation are reduced. The recirculation of flue-gas into the combustion air has proven to be a successful method for NO_x abatement in high-temperature combustion systems, such as wet-bottom boilers and oil- or gas-fired installations. Figure 3.32 is a schematic of this technique.

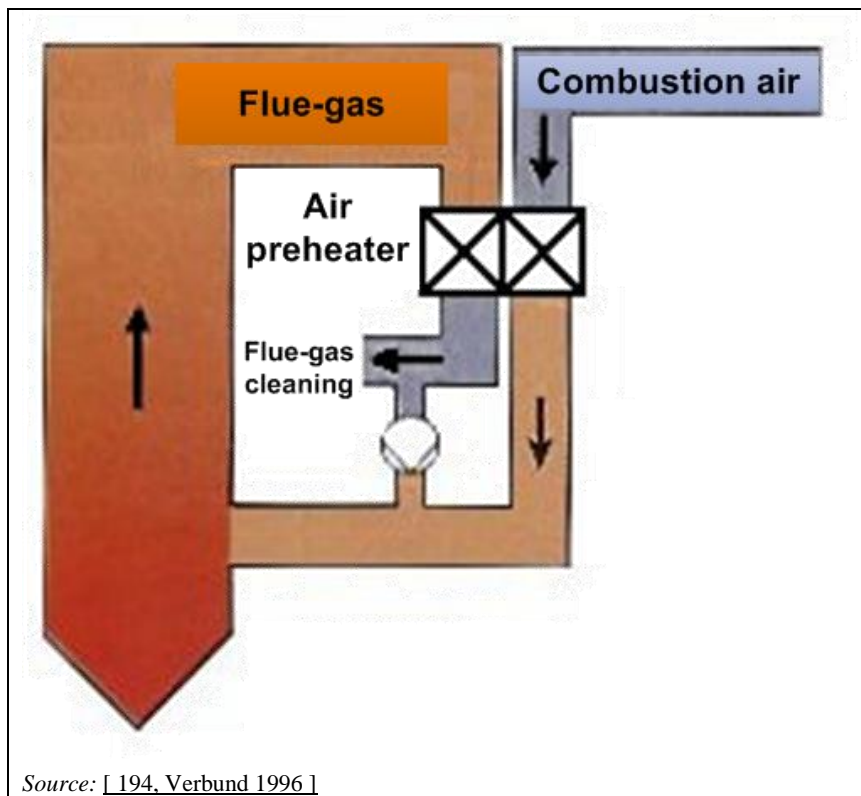

Figure 3.32: Flue-gas recirculation in a boiler

As can be seen in the figure above, part of the flue-gas (20–30 % at temperatures of about 350–400 °C) is withdrawn from the main flue-gas flow downstream of the air preheater, usually before any particulates have been removed, and then recycled to the boiler. The recirculated flue-gas can be mixed with combustion air upstream of the burner or with staging air. Special burners designed to operate on recirculated flue-gas are required with high flows to be recycled. In grate-fired boilers, separate FGR ports are also used.

A similar technique also applies to some engines: exhaust gas recirculation (EGR) can be a method for reducing NO_x emissions from large-bore two-stroke engines, but it requires solving certain problems associated with the cooling and cleaning of the exhaust gas before it is recirculated in the engine. The recirculated gases mainly consist of carbon dioxide, nitrogen, and water vapour, which help to reduce the combustion flame temperature. The clean-up of the exhaust gas leads to an acidic, dirty and oily sludge, which must be treated and disposed of. Any traces of sulphuric acid left in the cleaned gas may attack the turbocharger compressors and air coolers. For EGR up to 15 %, a NO_x reduction of up to 50 % has been reported. However, the above-mentioned problems need to be taken into account in the application of EGR. EGR in large four-stroke engines has only been tested in a laboratory environment so far. Due to increased smoke, particulate formation and much higher fuel consumption, EGR is not yet applicable to such engines and requires the development of new techniques enabling much higher fuel injection pressures.

Achieved environmental benefits

Reduced NO_x emissions to air.

Environmental performance and operational data

Table 3.19: Performance of the flue-gas recirculation technique for reducing nitrogen oxide emissions

General NO _x reduction rate*	General applicability	Applicability limitations	Remarks
20–60 % < 20 % for coal-fired boilers and 30–50 % for gas-fired plants combined with overfire air	All fuels	Flame instability	Retrofitting an existing boiler with flue-gas recirculation presents some adaptation difficulties, mostly due to efficiency losses of both the boiler and the burners, except when recirculating very small amounts of flue-gas. This NO _x abatement measure can be used alone or combined with air staging for retrofitting. Recirculation of flue-gas results in additional energy consumption due to the recirculation fan.
<p>NB: The NO_x reduction potential is very dependent on the NO_x generation level and on a number of site-specific factors. If different primary measures to reduce NO_x emissions are combined the reduction rate can, in general, not be added or multiplied. The combined reduction rate depends on a number of site-specific factors and is validated on a plant-by-plant basis. FGR can be used to maintain the temperature window necessary for high-dust SCR at partial and low loads. FGR can be used to maintain the reheating temperature at partial load, resulting in increased efficiency.</p>			

Cross-media effects

- FGR addition may slightly modify the heat exchange, with a slight increase in boiler flue-gas temperatures (e.g. from 222 °C to 228 °C in an example natural-gas-fired plant), resulting in a slight decrease in energy efficiency (e.g. 0.3 percentage points in the example plant case).
- Tendency to lead to higher unburnt carbon-in-ash.
- FGR may cause corrosion of inlet ducting and fans because the flue-gas is cooled when mixed with incoming air.

Technical considerations relevant to applicability

- The retrofitting of FGR requires the installation of ducting and controls and may be constrained by plant configuration.
- Component upgrades may be required to accommodate the larger volume and higher temperature incoming air/FGR mixture (e.g. fans).
- The retrofitting of FGR may force a reduction in the combustion unit capacity.
- Flame instability may limit the amount of FGR possible (and NO_x reduction) unless burner changes are made as well.
- Additional operating risks due to FGR failures and their impact on burner combustion need to be managed.
- If there is an excessive amount of recirculated flue-gas, this can lead to some operational limitations, e.g. corrosion problems when burning a fuel containing sulphur; efficiency losses due to a temperature increase at the stack; or increased energy consumption for the ventilators. Therefore, operators usually aim to limit the amount of recirculated flue-gas (to approximately 30 %) and compensate for the higher NO_x emissions by using advanced low-NO_x burners.

Economics

The retrofitting of FGR costs approximately EUR 50 000 for a 20 MW_{th} boiler, and to include it in a new boiler costs approximately EUR 20 000.

Driving force for implementation

Reduction of NO_x emissions.

Example plants

About 100 plants that submitted a questionnaire in 2012 for the review of this document are fitted with FGR.

Reference literature

No information provided.

3.2.2.3.4 Reduction of combustion air temperature

Description

Reduction of combustion air preheating to lower the combustion flame temperature and limit the generation of thermal NO_x.

Technical description

The combustion air preheat temperature has a significant impact on NO_x formation, mainly for gas- and oil-firing systems. For these fuels, the main part of NO_x is caused by the thermal NO mechanism, which depends on the combustion temperature. Reduction of the air preheat temperature results in lower flame temperatures (peak temperatures) in the combustion zone. Accordingly, a lower formation of thermal NO_x results. For a small unit, removing the air preheater may be the most justified action.

Achieved environmental benefit

Reduced NO_x emissions.

Environmental performance and operational data

The general reduction rate is 20–30 %. The level of emission reduction achievable mainly depends on the initial air preheat temperature and on the temperature that is achieved after this measure has been implemented.

Cross-media effects

There are two major drawbacks of this technology. First, in several boilers, e.g. those burning coal or wet biomass, high combustion temperatures are required and accordingly high air preheat temperatures are essential for the proper functioning of the combustion installation. Second, lowering the air preheat temperature results in higher fuel consumption, since a higher portion of the thermal energy contained in the flue-gas cannot be utilised and ends up leaving the plant via the stack. This can be counterbalanced by utilising certain energy conservation methods, such as increasing the size of the economiser.

Technical considerations relevant to applicability

This technique is not suitable for coal-firing wet-bottom boilers and boilers firing wet biomass.

Economics

The cost of removing the combustion air preheater is plant-specific.

Osiris, the energy service company providing utilities in the Les Roches–Roussillon Chemical Platform, calculated in 2012 that the cost of the retrofit of its 60 MW_{th} natural-gas-fired boiler would amount to EUR 3 300 000. This included:

- removal of the rotary heat exchanger;

- installation of a new energy recovery heat exchanger, with a sweep system for emergency operation using fuel oil;
- replacement of the combustion air fan as the air volume will be very different;
- adaptation of the burners for operation at low temperature;
- review of the settings of the burners;
- installation of feed-water piping to supply the new economiser;
- installation of steam piping for the sweeping of the economiser;
- update of the entire regulation system.

Driving force for implementation

Reduction of NO_x emissions.

Example plants

No information provided.

Reference literature

[195, OSIRIS 2012]

3.2.2.3.5 Low-NO_x burners

Description

The technique (including ultra- or advanced- low-NO_x burners) is based on the principles of reducing peak flame temperatures; boiler burners are designed to delay but improve the combustion and increase the length of the flames, allowing the heat radiated during combustion to reduce peak temperatures. The air/fuel mixing reduces the availability of oxygen and reduces the peak flame temperature, thus retarding the conversion of fuel-bound nitrogen to NO_x and the formation of thermal NO_x, while maintaining high combustion efficiency. This may be associated with a modified design of the furnace combustion chamber. The design of ultra-low-NO_x burners (ULNBs) includes combustion staging (air/fuel) and firebox gases' recirculation (internal flue-gas recirculation).

Technical description

Low-NO_x burners have reached a mature stage of development, but further improvements are ongoing and a considerable amount of research work is still devoted to the enhancement of existing low-NO_x burner systems. Since design details of low-NO_x burners differ significantly from manufacturer to manufacturer, only the general principle is referred to here.

In a classical combustion installation, the combined fuel and air/oxygen mix is entirely injected at the same place. The resulting flame is then composed of a hot and oxidising primary zone located at the flame root and a colder secondary zone located at the flame end. The primary zone generates most of the NO, which increases exponentially with temperature, whereas the contribution of the secondary zone is rather modest.

Low-NO_x burners (LNBs) modify the means of introducing air and fuel to delay the mixing, reduce the availability of oxygen, and reduce the peak flame temperature.

According to the different principles to reduce the formation of NO_x, low-NO_x burners have been developed as air-staged burners, flue-gas recirculation burners and fuel-staged burners.

Air-staged low-NO_x burners

In the air-staging process, the primary air is mixed with the total quantity of fuel, producing a fuel-rich flame, which is both relatively cool and deficient in oxygen; in these conditions the

formation of nitrogen oxides is inhibited. The fuel-air mixture and the secondary air as shown in Figure 3.33 create a substoichiometric combustion zone (primary flame). An internal recirculation zone is created due to the swirl of the secondary air and the conical opening of the burner, which heats up the fuel rapidly. The swirl of the secondary flame is necessary for flame stability. The volatile compounds are freed in the primary flame, together with the majority of the nitrogen compounds. By operating a fuel-rich / air-lean mixture with a high concentration of CO, the oxidation of the nitrogen compounds to NO is limited. With the secondary air, a burnout zone is created, in which a slow combustion of the unburnt fuel takes place at relatively low temperatures. The low O₂ concentration provides for NO_x control at this stage.

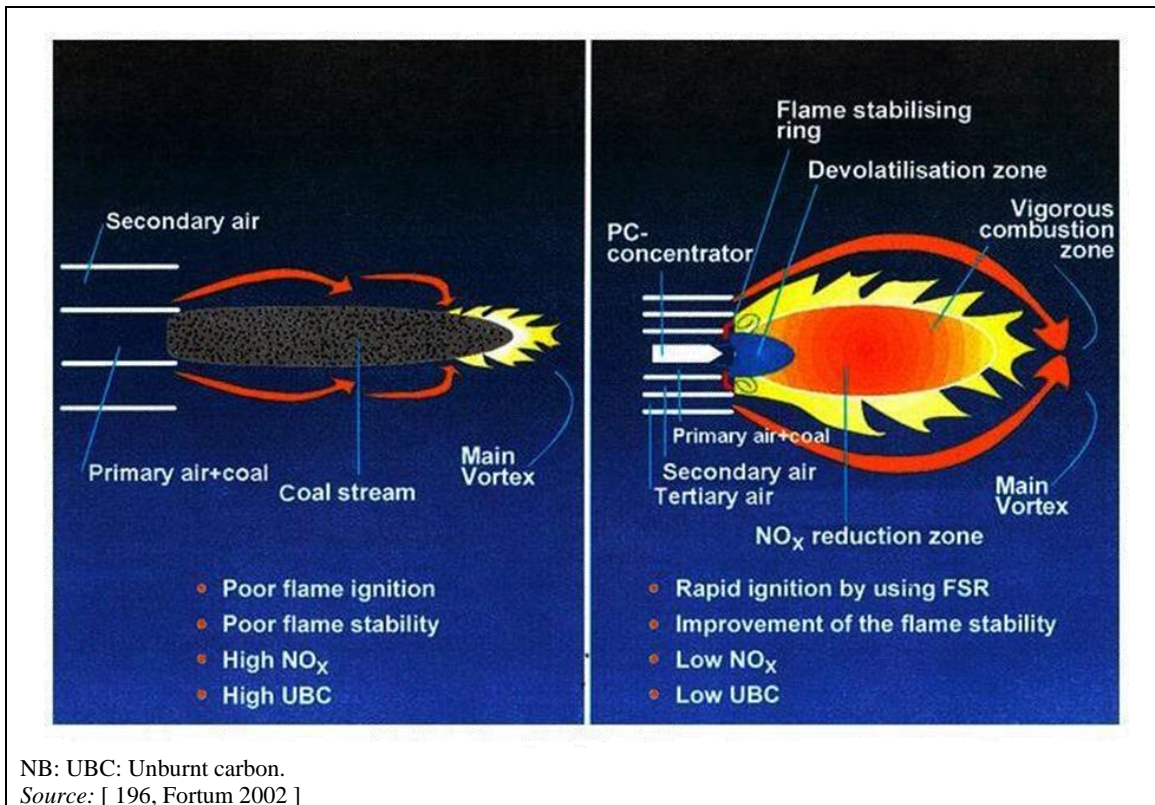
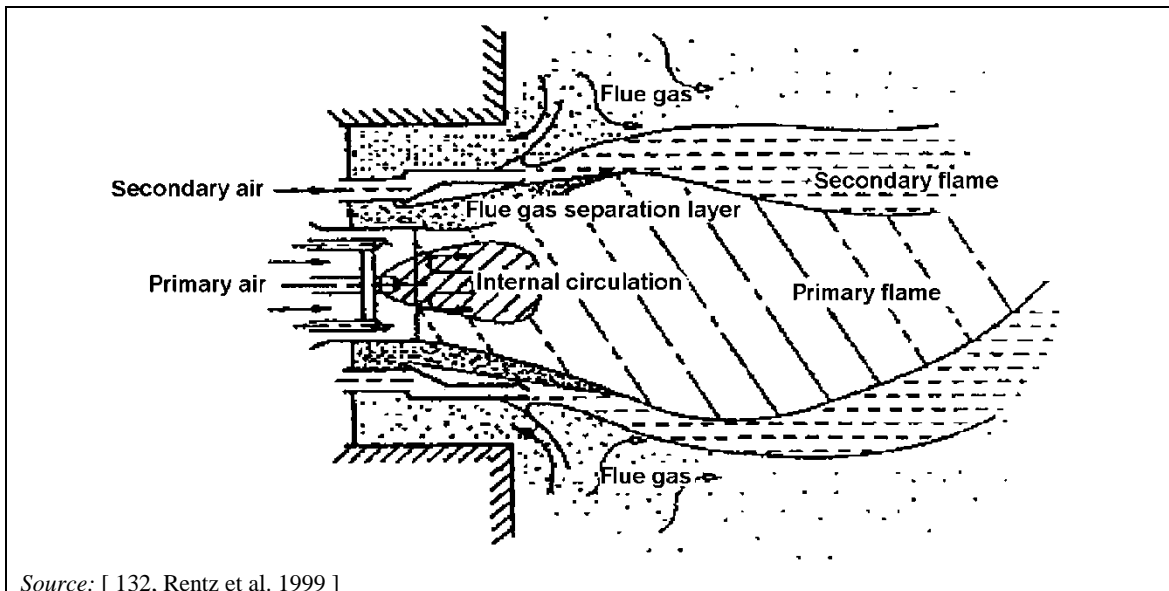

Figure 3.33: Comparison of conventional air-staged and advanced air-staged low-NO_x burners

Flue-gas recirculation low-NO_x burners

For solid fuels and for liquid fuels with a nitrogen content between 0.3 wt-% and 0.6 wt-%, fuel NO dominates over thermal NO (typically 75 % fuel NO). Therefore, besides flame temperature reduction acting on thermal NO, the oxygen content also needs to be reduced without producing more unburnt carbon. The solution is a technique involving separated flames with internal recirculation of the flue-gas. By injecting a portion of the flue-gas into the combustion zone or combustion air supply, both flame temperatures and oxygen concentrations are lowered, enabling a reduction of NO_x formation.



Source: [132, Rentz et al. 1999]

Figure 3.34: Flue-gas recirculation low-NO_x burners

The basic function is similar to that of the air-staged low-NO_x burner, but the distances between primary and secondary nozzles are larger, therefore a flue-gas layer develops. In these burners, 15–25 % of the hot flue-gas is internally recirculated, along with the combustion air, into the burnout air. The flue-gas acts as a diluent, reducing the flame temperature and partial pressure of oxygen, thus reducing NO_x formation. Internal recirculation is generally operated in liquid fuel firing and in the latest generation of combined gas and oil LNBs.

Fuel-staged low-NO_x burners

The fuel-staged burner aims to reduce the NO_x already formed by the addition of part of the fuel in a second stage. Fuel-staged LNBs are mostly used for gas applications.

This technique begins with combustion of a portion of the fuel with high excess air, making relatively low flame temperatures possible, which inhibit the formation of nitrogen oxides. The internal recirculation zone and the near-stoichiometric combustion ensure flame stability. As the combustion nears completion in the primary zone, additional fuel (optimum ratio between 20 % and 30 %) is injected downstream of the primary flame to form the secondary flame, which is extremely substoichiometric. An atmosphere is created in which the NO_x already formed can be reduced to N₂ by NH₃, HCN, and CO radicals. The burnout zone is formed in a third stage. The flame of this type of burner is about 50 % longer than that of a standard gas burner.

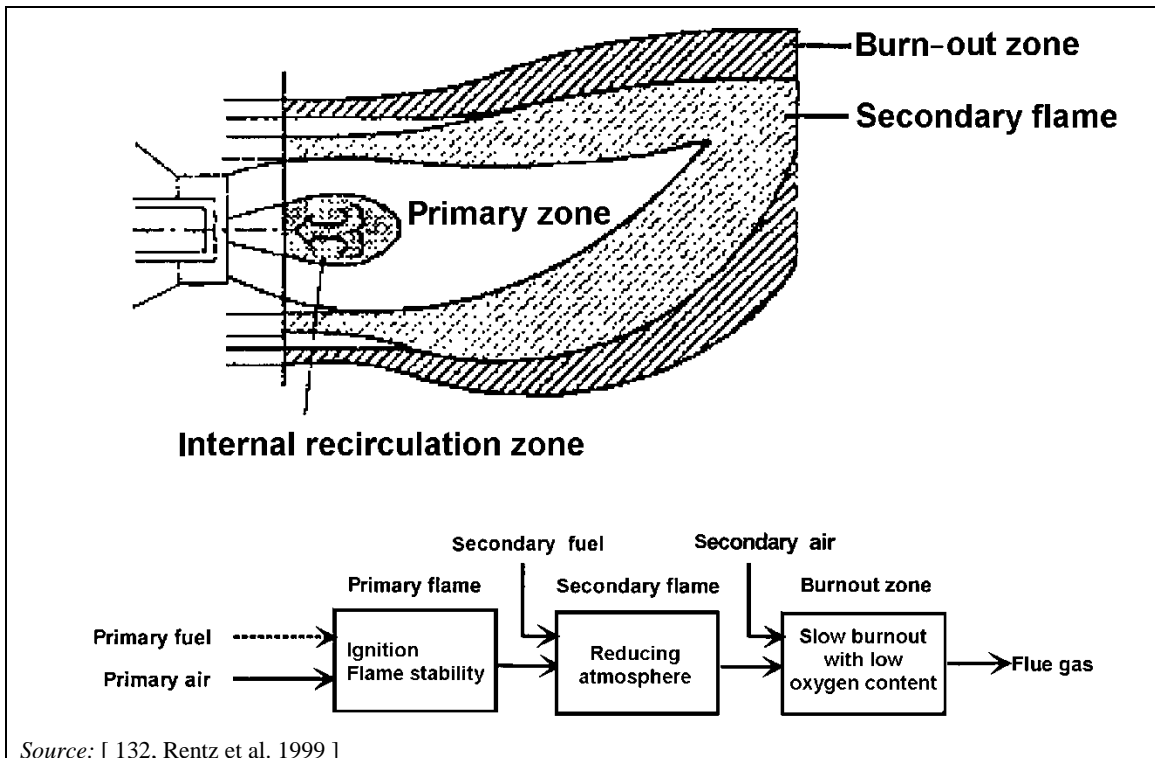

Source: [132, Rentz et al. 1999]

Figure 3.35: Fuel staging at the burner

New generation of low-NO_x burners

The most recent designs of LNBs (called 'hybrid low-NO_x burners' or 'ultra-low-NO_x burners') use a combination of air staging, fuel staging and internal flue-gas recirculation along with new techniques in order to enable ultra-low NO_x emissions. Variable split fuel staging is also employed or the use of lean premix combustion in the case of gas burners. A drawback of first-generation low-NO_x burners is the need for sufficient room to allow the flame separation: the diameter of low-NO_x flames is about 30–50 % larger than that of classical flames. Compared with classical and compact-flame LNBs, ULNBs can achieve similar NO_x reductions with a smaller impact on flame shape, or larger reductions if sufficient firebox volume is available. Another new generation of burners dedicated to the low-NO_x combustion of gaseous fuel uses the expansion energy of the gaseous fuel under pressure, mainly injected peripherally into the main combustion airflow, to draw some flue-gas from the combustion chamber, to mix it with the gaseous fuel before it enters the heart of the flame. This technique enables an accumulation of effects: a decrease in the flame temperature and in the oxygen partial pressure, similar to low-NO_x burners of the previous generation; but also a decrease in the fuel partial pressure, drastically reducing the peak temperature within the flame and contributing to a further reduction of thermal NO_x.

Achieved environmental benefits

Reduced NO_x emissions to air.

Environmental performance and operational data

Table 3.20: Performance of the low-NO_x burner technique for reducing nitrogen oxide emissions

Primary measure		General NO _x reduction rate*	General applicability	Applicability limitations
Low-NO _x burner (LNB)	Air-staged LNB	25–35 %	All fuels	Flame instability Incomplete burnout
	Flue-gas recirculation LNB	Up to 20 %	All fuels	Flame instability
	Fuel-staged LNB	50–60 %	All fuels	Flame instability Incomplete burnout
	New-generation LNB	50–70 %	All fuels	NA

NB:
 When combining different primary measures to reduce nitrogen oxide emissions, the reduction rate can, in general, not be added or multiplied. The combined reduction rate depends on a number of site-specific factors and is validated on a plant-by-plant basis.
 Not all of the primary measures can be applied to all existing boilers; their application depends on the combustion configuration and the fuel.
 Low-NO_x burners can be used in combination with other primary measures such as overfire air and reburning or flue-gas recirculation.
 Low-NO_x burners with overfire air can achieve reduction rates of 35–70 %. [[148, CIEMAT 2000](#)]
 NA: Not available.

It has been claimed that modern air-staged LNB designs for wall-fired coal boilers (with an optimised nozzle or swirl for secondary air injection, and a deflector for secondary/tertiary air injection) can achieve NO_x reductions of up to 50 % without OFA, and up to 70 % with OFA.

In lignite-fired power plants, NO_x emission reductions can be up to 75 % with LNBs, OFA and/or flue-gas recirculation.

For boiler applications, there are currently few implemented lean premix burners in industrial natural-gas-fired boilers. This technique has been successfully implemented in an industrial boiler in France in 2014 and in steam generators used in the oil and gas sector in the USA. NO_x emissions of a lean premix combustion burner (before fuel staging injection) in a gas boiler depend on the excess air levels and on the quality of the mix between air and gaseous fuel. NO_x emissions are very sensitive to excess air levels. An excess air level of 40–80 % is needed in order to achieve very low NO_x emissions (less than 20 mg/Nm³). Below this threshold of 40 %, NO_x emissions promptly increase and reach usual NO_x values. Above 80 %, the flame temperature is very low and the stability of the lean premix combustion may be affected. NO_x levels below 50 mg/Nm₃ are generally achieved with this technique. Tests carried out at a demonstration-scale application have shown that NO_x emission levels around 20–30 mg/Nm³ (at 3 % O₂) are achievable when a lean premix burner is used in conjunction with external flue-gas recirculation, at the expense of higher capex and opex.

Cross-media effects

As the pressure drop in air ducts increases in comparison with standard burners, it may result in operational expenses. Coal pulverisation, for instance, must usually be improved, and that may lead to higher operating and maintenance costs. There could also be some corrosion problems or impacts on equipment safety and reliability due to lack of combustion stability, especially if the process is not properly controlled.

There is no measurable effect of LNBs on the energy efficiency, waste gas temperatures and steam production, in the case of natural-gas-fired plants.

The implementation of low-NO_x burners may increase the level of carbon-in-ash, which should be kept within a set limit so as not to jeopardise the management of these combustion residues. The addition of classifiers to the coal mills, which improves the fineness of the pulverised coal,

is an efficient way to counterbalance this problem. Modern coal LNBS are efficiently designed not to influence the carbon-in-ash level.

Low-NO_x burners may also increase CO generation due to cooler, larger flames. This generation will increase at low loads.

Technical considerations relevant to applicability

For the application of advanced low-NO_x burners to existing boilers, it should be noted that in older installations the furnaces will usually have been built as small as possible (designed for high combustion intensity). Therefore, the furnace temperature, and thus the NO_x generation, can only be reduced to a limited extent. In addition, the furnace depth may only accommodate slightly longer flames than it was originally designed for.

The applicability of lean premix burners for gas boilers with preheated air (> 150 °C) or process gases with a high hydrogen content or variable compositions is not yet demonstrated.

Economics

The low-NO_x burning technique requires, as a minimum, the burners to be changed and, often, installation of an overfire air (OFA) system. If the existing burners are classical burners, then changing the burners can almost always be done very cost-effectively. If the burners are delayed-combustion low-NO_x burners (old type), the benefits of retrofitting them into rapid-injection low-NO_x burners can be assessed only on a case-by-case basis.

Low-NO_x burners with OFA for a 250 MW_{th} solid fuel boiler cost approximately EUR 1.7 million. In coal-fired boilers, the cost of NO_x reduction is around EUR 500 per tonne of NO_x reduced.

For new installations, the additional investment for a low-NO_x burner compared to a classical burner can be considered negligible. For retrofits, possible modifications to the installation have to be taken into account, which are very often plant-specific and thus not quantifiable in general terms. The supplementary operating costs required to operate low-NO_x burners are, to a large extent, due to the additional energy consumption, which is necessary due to:

- the need for larger fans, as larger pressure drops occur across the burners;
- the need to ensure improved coal pulverisation, in order to attain efficient combustion under the reduced air conditions experienced in the burners.

Driving force for implementation

Reduction of NO_x emissions.

Example plants

About 200 plants that submitted a questionnaire in 2012 for the review of this BREF are fitted with LNBS.

See specific fuel sections for further examples.

Reference literature

[197, ADEME 2015]

3.2.2.3.6 Fuel staging (reburning)

Description

The technique is based on the reduction of the flame temperature or localised hot spots by creation of several combustion zones in the combustion chamber with different injection levels of fuel and air, allowing the conversion of the NO_x formed back to nitrogen.

Technical description

Fuel staging, also termed reburning, is based on the creation of different zones in the furnace by the staged injection of fuel and air. The aim is to reduce back to nitrogen the nitrogen oxides that have already been formed. As can be seen from Figure 3.36, the combustion can be divided into three zones.

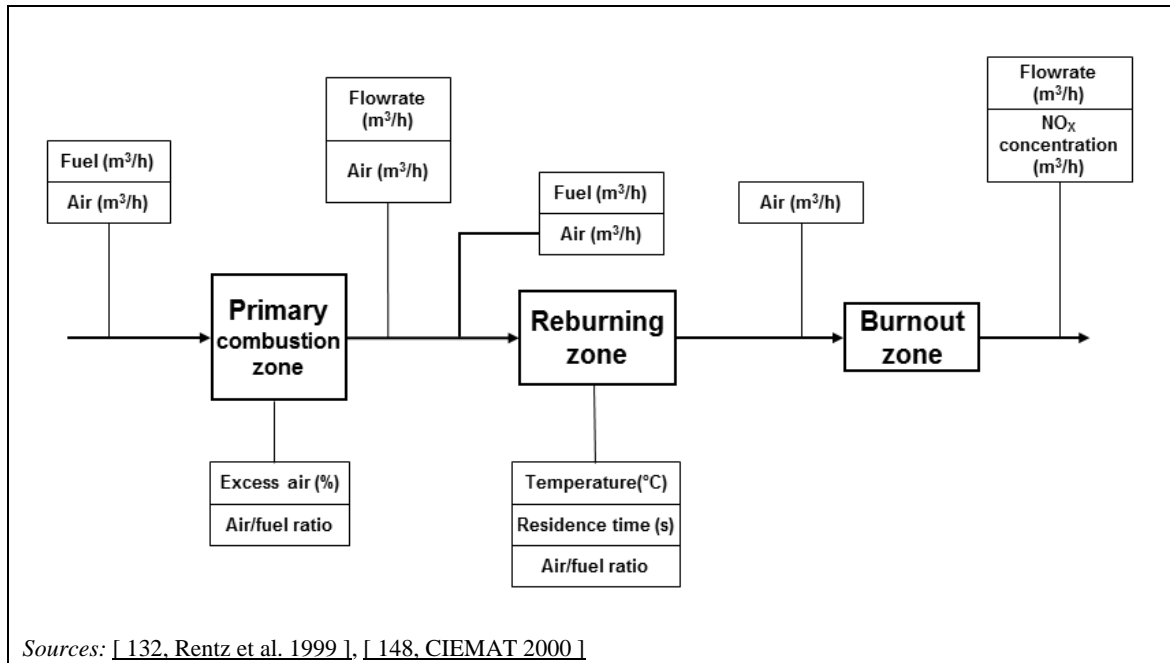

Figure 3.36: The three combustion zones and relevant parameters in a reburning process

Reburning involves combustion occurring in three zones:

- Primary combustion zone (which may be equipped with primary measures): 80–85 % of the fuel is burnt in an oxidising or slightly reducing atmosphere. This primary burnout zone is necessary in order to avoid the transfer of excess oxygen into the reburning zone, which would otherwise support possible NO_x formation.
- Second combustion zone (often called the reburning zone): secondary or reburning fuel is injected into a reducing atmosphere. Hydrocarbon radicals are produced, reacting with the nitrogen oxides already formed in the primary zone; other unwanted volatile nitrogen compounds like ammonia are generated as well.
- Third combustion zone: the combustion is finally completed through the addition of final air into the burnout zone.

Different fuels can serve as reburning fuel (pulverised coal, fuel oil, natural gas, etc.), but natural gas is generally used due to its inherent properties. Figure 3.37 shows the advantage of natural gas over coal or oil.

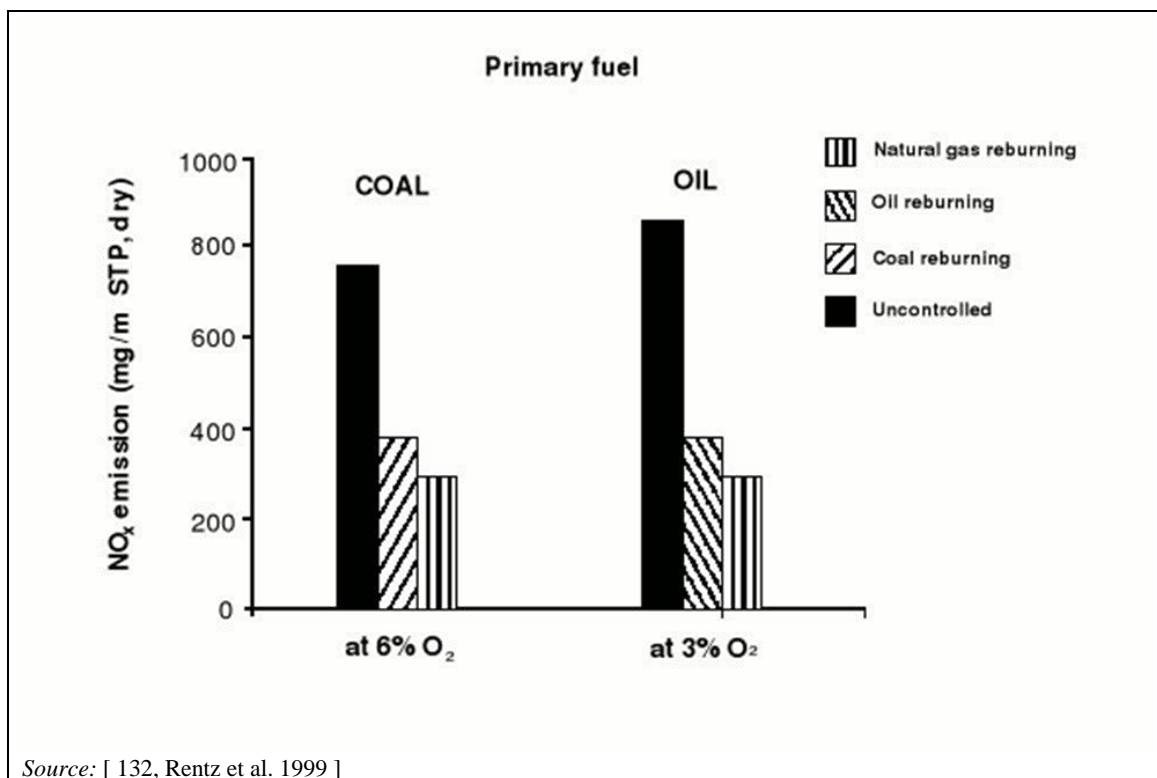

Figure 3.37: Comparison of coal, oil and natural gas as reburning fuel

Achieved environmental benefits

Reduced NO_x and CO emissions to air.

Environmental performance and operational data

Table 3.21: Performance of the fuel staging (reburning) technique for reducing nitrogen oxide emissions

General NO _x reduction rate*	General applicability	Remarks
50–60 % (70–80 % of the NO _x formed in the primary combustion zone can be reduced)	All fuels	<p>Reburning offers some advantages, such as compatibility with other primary NO_x emission reduction measures, simple installation of the technique, use of a standard fuel as the reducing agent, and very small amounts of additional energy. The additional energy consumption by reburning 'coal over coal' can be higher than using natural gas as a reburning fuel.</p> <p>Combustion downstream of the primary zone also produces nitrogen oxides.</p> <p>When using natural gas as the reburning fuel, dust and SO₂ are also reduced in direct proportion to the amount of coal replaced. CO₂ is reduced in proportion to the amount of carbon replaced with hydrogen (in methane).</p>
<p>NB: The NO_x reduction potential is very dependent on the NO_x generation level and on a number of site-specific factors. If different primary measures to reduce NO_x emissions are combined the reduction rate can, in general, not be added or multiplied. The combined reduction rate depends on a number of site-specific factors and is validated on a plant-by-plant basis.</p>		

The efficiency rate of reburning depends on several parameters, including the following:

- Temperature: to obtain low NO_x values, the temperature in the reburning zone should be as high as possible (1 200 °C). Figure 3.38 shows the denitrification rate as a function of the reburning rate at different temperatures.
- Residence time: increasing the residence time in the reburning zone favours NO_x reduction. An appropriate time is between 0.4 seconds and 1.5 seconds.
- Aeration rate in the reburning zone: the stoichiometry should be in the range $\lambda = 0.7\text{--}0.9$.
- Fuel type.
- Quality of the mixing of the additional fuel and the flue-gas generated by the primary combustion zone. Natural gas usually enables homogeneous combustion, resulting in a very short residence time for burnout.
- Excess air in the primary combustion zone: the stoichiometry is approximately $\lambda = 1.1$.

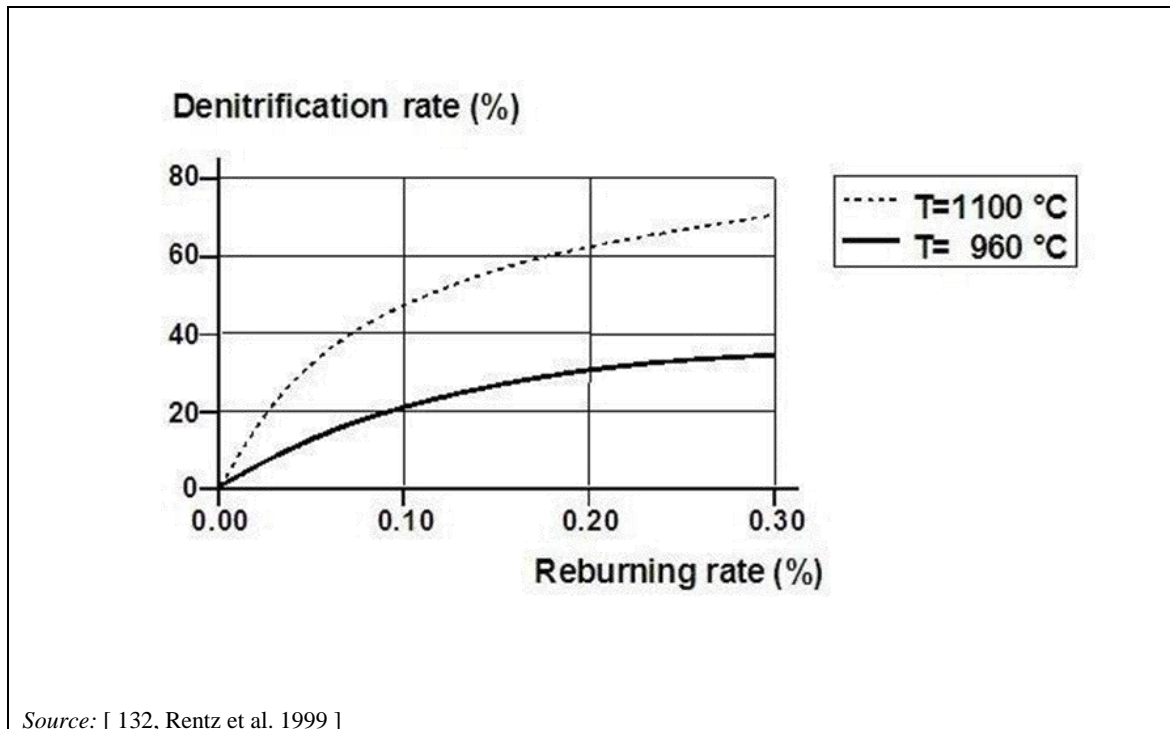

Figure 3.38: Denitrification rate as a function of the reburning rate

Cross-media effects

When using coal or oil as reburning fuel, nitrogen is present in a certain quantity, leading inevitably to NO_x formation in the burnout zone. This drawback can be reduced or avoided by using natural gas.

Technical considerations relevant to applicability

In principle, the reburning technique can be implemented in all types of fossil-fuel-fired boilers and in combination with low- NO_x combustion techniques (for the primary fuel). In practice, reburning is not commonly used in existing utility boilers firing liquid or gaseous fuels as primary fuels. This abatement technique, while very attractive for new boilers, necessitates large chamber volumes if high amounts of unburnt carbon are to be avoided. Therefore, reburning may be less appropriate for retrofits, due to possible space constraints in existing installations. The retrofit may be less efficient in the case of smaller plants than in larger plants.

As mentioned earlier, major problems are caused by incomplete combustion. This measure best suits boilers that have a long enough residence time and where proper reburning of fuel is available at a reasonable price. Natural gas has proven to be the best reburning fuel, mostly because it is easily flammable and does not contain particles or sulphur.

Coal over coal reburning requires an ultrafine pulverising system and associated milling plant, cyclones and classifiers to achieve this fineness.

Economics

The costs of reburning depend on the structure of the boiler and on the fuel used. The use of auxiliary fuel, such as natural gas, also incurs costs but, on the other hand, it releases heat to the process and can therefore be considered a usable fuel. So the calculations should be made for the whole power plant economy, including possible changes, e.g. in the boiler efficiency.

Experience shows that reburning is not as cost-effective as low-NO_x burners with OFA, but it is still an appropriate measure for reducing NO_x emissions. One estimate gives reburning costs as close to EUR 2.5 million for a 250 MW_{th} boiler. The operating costs for reburning have also been calculated as twice as high as the costs for low-NO_x burners with OFA.

Driving force for implementation

Reduction of NO_x emissions.

Example plants

Reburning has been installed at large power plants in the US, Japan, the Netherlands, Germany, Italy and the UK. In Italy, reburning (with oil as a reducing agent) has been implemented successfully in many large oil-fired units.

Reference literature

No information provided.

3.2.2.3.7 Dry low-NO_x (DLN) burners

Description

Gas turbine burners that include the premixing of the air and fuel before entering the combustion zone. By mixing air and fuel before combustion, a homogeneous temperature distribution and a lower flame temperature are achieved, resulting in lower NO_x emissions. DLN is a generic name commonly used throughout the industry to represent a range of similar technologies (DLN, DLE, SoLoNO_x, etc.).

Technical description

The basic characteristic of dry low-NO_x burners (see Figure 3.39) is that the mixing of the air and fuel and the combustion both take place in two successive steps. Lean premix systems are more dependent on the precision engineering than conventional diffusion flame systems as they require a careful balance to minimise both NO_x and CO emissions. By mixing combustion air and fuel before combustion, a homogeneous temperature distribution and a lower flame temperature are achieved, resulting in lower NO_x emissions. A turbine includes between 30 and 75 premixers.

The primary burner DLN system has the following basic components: fuel/air injection system, premixing zone, and flame stabilisation zone. The fuel/air injection system is designed to promote rapid and uniform distribution of the fuel into the air using multiple (small) fuel injection points. The mixing zone is designed to allow sufficient time to promote uniform mixing and the aerodynamics of the flame. The stabilisation zone is designed to prevent flame propagation into the mixing zone, known as flashback, which can cause severe damage to the combustor.

Low-load flame stabilisation in the primary burners is achieved by use of a diffusion pilot system that places the fuel directly in the flame stabilisation zone. This creates high localised temperatures, so that the flame is not extinguished but leads to an increase in NO_x when compared with premix operation. Low-load operation therefore tends to generate increased NO_x levels. At the same time, CO emissions increase in the transitional time taken to reach the minimum stable generation level, since the additional air causes quenching of the flame, which

results in a lower combustion efficiency. There may be a deterioration of performance observed over time due to changes in air leakage paths within the turbine, for example. Thus the system operates in distinct combustion modes to allow operation from start-up to baseload at minimum NO_x emission levels over the full operating range of the gas turbine.

DLN providers are still increasing the efficiency of the technique by means of slight improvements, such as a special axial swirler which provides a better pilot gas/air distribution to enhance the fuel/air mixing and therefore to reduce flame temperature peaks, in order to reduce NO_x emissions; or new technology that extends the gas/air premix, typically only in the main burner, but also innovatively in the pilot burner.

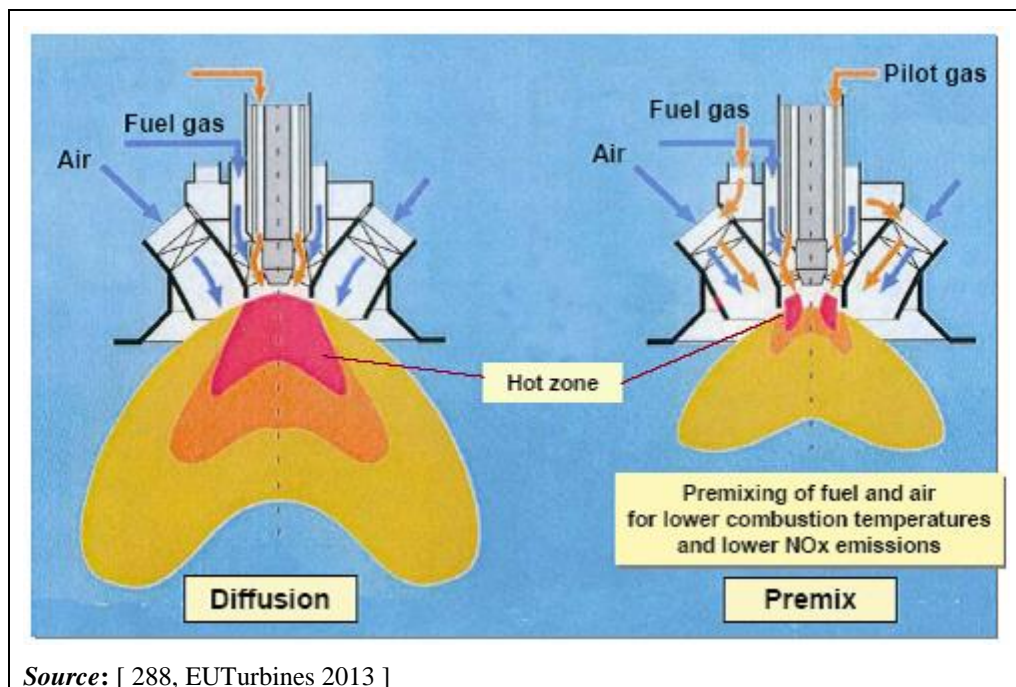

Figure 3.39: Schematic of a DLN (premix) combustion chamber

Achieved environmental benefits

- Reduced NO_x and CO emission.
- No extra use of water/steam or ammonia needed to reduce NO_x emissions.

Environmental performance and operational data

Dry low- NO_x systems are very effective and reliable for natural gas firing.

NO_x emissions can be reduced by as much as 90 % and there is also an improvement in energy efficiency (improvement in electrical yield of 4–5 %) (see Plant 74). Older dry low- NO_x versions may have higher NO_x levels than recently developed versions.

For part-load operation, an increase of CO and NO_x emissions will usually be noted compared with stable baseload operation. Some suppliers have recently developed systems that limit this increase (see Section 7.1.3.2.4).

Hybrid DLN have been operated on gas oil in premix mode for some years: a considerable NO_x reduction has been achieved, but the values achieved are not as low as for the combustion of natural gas.

Similarly, dry low-NO_x combustion systems for dual-fuel-fired (gas – gas oil) gas turbines have been developed and are now available, however with higher NO_x emission levels than from natural-gas-fired systems.

Cross-media effects

Humming issues (high acoustics in the combustion chamber) may arise when operating the gas turbine at maximum load at a low ambient temperature and in the case of a sudden change of natural gas quality.

Technical considerations relevant to applicability

Dry low-NO_x combustion is very model-specific, i.e. all the manufacturers develop their own technology for each model where there is enough demand to justify the research necessary to develop it.

Thus DLN are applicable for all new natural-gas-fired turbines (single- or dual-fuel-fired), and for most existing turbines as a retrofit package. For older models or models with low demand for the technology, they may not be available.

Retrofitting the DLN technique in existing gas turbines with steam/water injection may not always be technically feasible.

Further developments are necessary for gas turbines utilising fuel oils as, in these turbine operations, not only does premixing of the air and fuel have to be carried out before combustion, but so does evaporation of the liquid fuel. As the particle size has an impact on the evaporation velocity, current research is focusing on developing more efficient atomiser systems.

Economics

The cost of DLN to be retrofitted can vary dramatically for the same size turbine offered by different manufacturers. As an example, the incremental cost of a DLN combustor for a new gas turbine from manufacturer A (5.2 MW) was approximately EUR 180 000, whereas the incremental cost for a similar DLN combustor from manufacturer B (5.1 MW) was EUR 20 000. The cost discrepancy is related to performance capabilities, design complexity and reliability/maintenance factors. Investment costs for retrofitting can be estimated as EUR 20–40/kW_e. Retrofits cost approximately from EUR 2 million to EUR 4 million for a 140 MW_{th} gas turbine for a modern dry low-NO_x burner, depending on the original/final situations and on the type of plant/retrofit, and the operation and maintenance cost is approximately EUR 500 000 per year. Due to their high efficiency, new burners are very economical to operate, especially as there are no great losses of energy from fuel losses, or in the form of hydrocarbons, etc. The investment costs are approximately 15 % higher and maintenance costs about 40 % higher than non-DLE gas turbines.

For new plants, it can be assumed that dry low-NO_x combustors are nowadays no more expensive than the former conventional combustors. Therefore, for new installations, the additional costs for using dry low-NO_x combustors can be considered negligible. A capex of EUR 2.5 million has been reported for a newly built 700 MW_{th} CCGT.

Due to the reduced heat load, the hot gas path components have a longer lifetime than when wet emission controls are used, (e.g. a six-year lifespan compared with an approximate five-year lifespan with a wet system in a reported example plant), resulting in a reduction in maintenance costs.

Driving force for implementation

Low emission levels of NO_x and CO.

Example plants

Today, almost all gas turbines in industrial use are equipped with dry low-NO_x systems.

Reference literature

[132, Rentz et al. 1999] [167, Austrian Ministry of Environment 2000] [198, OSEC 1999]

3.2.2.3.8 Low-NO_x combustion concept in engines**Description**

The technique consists of a combination of internal engine modifications, e.g. combustion and fuel injection optimisation (the very late fuel injection timing in combination with early inlet air valve closing), turbocharging or Miller cycle.

Technical description

Retarding the start of the injection to reduce the firing pressure is a simple way of reducing NO_x emissions. It reduces the peak combustion temperature level and, in response, the combustion process progressively moves into the expansion process. In the injection retard method, the burning temperature peak is lowered. Initially, the drawback of this method was the increased specific fuel consumption, so, in order to re-establish low fuel consumption, the compression ratio of the engine was increased as a countermeasure, resulting in lower NO_x emissions and no penalty in terms of fuel consumption.

Very late fuel injection timing in combination with a high compression ratio requires a sophisticated modification of the injection rate, as well as costly development of a new combustion chamber shape design. Sophisticated fuel injection equipment is consequently a key element in this technique. The continuing technological development of the diesel components has made it possible to further optimise the diesel cycle with the 'Miller concept', corresponding to an early inlet valve closing. In this concept, some components have been further developed, such as the turbocharger, fuel injection pumps, fuel injection nozzles and the camshaft. Today the 'Miller concept' is a standard application for big four-stroke diesel engines. Several Miller steps have been introduced since the first generation of low-NO_x systems at the end of 1990s. The bottleneck for implementation of the next generation has been the turbochargers; considerable development efforts were needed on these and subsequent proper testing before commercial introduction in different engine configurations. The Miller concept is an inbuilt concept for big engines and has enabled compliance with the current minimum global emission ruling for international projects. [199, IFC 2007]

Achieved environmental benefits

Reduced NO_x emissions to air.

Environmental performance and operational data

By implementing the low-NO_x combustion concept in combination with the Miller concept, NO_x emissions have been reduced by up to about 40 % in today's engines compared to the same engine type at the beginning of 1990s, whilst maintaining high efficiency. Feedback from the industry on the Miller concept implementation suggests a typical NO_x reduction closer to 30 %, which is strongly dependent on the type of engine and on the performance of the turbocompressor.

For a modern engine, the NO_x reduction achieved by retarding the start of the injection might be around 10 % (applicability dependent on engine type) but, due to the increased fuel consumption, this technique is rarely used as the sole measure.

Cross-media effects

With late fuel injection timing, some negative side effects are still reported: an increase in both unburnt hydrocarbons and solid particulate emissions, an increase in the fuel consumption (1 % for every 4–5 % of NO_x reduced) and in the CO₂ emissions.

Technical considerations relevant to applicability

No information provided.

Economics

No information provided.

Driving force for implementation

Reduction of NO_x emissions.

Example plants

No information provided.

Reference literature

No information provided.

3.2.2.3.9 Lean-burn concept

Description

The control of the peak flame temperature through lean-burn conditions is the primary combustion approach to limiting NO_x formation in gas engines. Lean-burn combustion decreases the fuel to air ratio in the zones where NO_x is generated, so that the peak flame temperature is lower than the stoichiometric adiabatic flame temperature, therefore reducing thermal NO_x formation.

Technical description

Among natural gas engine options, lean-burn natural gas engines generate the lowest NO_x emissions directly from the engine. It is called 'advanced' when the system is tuned to achieve NO_x levels below 100 mg/Nm³ (15 % O₂). The latter is possible with a spark plug ignited engine (or with SG-type engines ignited with alternative systems currently in R&D stage) but not for the low-pressure gas dual fuel-type engines.

Diesel engines produce higher combustion temperatures and more NO_x than lean-burn gas engines, even though the overall diesel engine air to fuel ratio may be very lean. There are three reasons for this: (1) heterogeneous near-stoichiometric combustion, (2) the higher adiabatic flame temperature of distillate fuel, and (3) fuel-bound nitrogen. The diesel fuel is atomised as it is injected and dispersed in the combustion chamber. Combustion largely occurs at near-stoichiometric conditions at the air droplet and air fuel vapour interfaces, resulting in maximum temperatures and higher NO_x. In contrast, lean premixed homogeneous combustion used in lean-burn gas engines results in lower combustion temperatures and lower NO_x production.

For any engine, there are generally trade-offs between low NO_x emissions and high efficiency. There are also trade-offs between low NO_x emissions and emissions of the products of incomplete combustion (CO and unburnt hydrocarbons). There are three main approaches to these trade-offs that come into play depending on regulations and economics. One approach is to aim for the lowest NO_x emissions, accepting a fuel efficiency penalty and possibly higher CO and hydrocarbon emissions. A second option is finding an optimal balance between emissions and efficiency. A third option is to design for the highest efficiency and use post-combustion exhaust treatment.

Control of the combustion temperature has been the principal focus of combustion process control in gas engines. Combustion control requires trade-offs: high temperatures favour complete burnout of the fuel and low residual hydrocarbons and CO, but promote NO_x formation. Lean-burn combustion dilutes the combustion process and reduces combustion temperatures and NO_x formation, and allows a higher compression ratio or peak firing pressures, resulting in higher efficiency. However, if the mixture is too lean, misfiring and incomplete combustion occur, increasing CO and VOC emissions.

Achieved environmental benefits

Reduced NO_x emissions to air.

Environmental performance and operational data

Most lean-burn engines use turbocharging to supply excess air to the engine and produce the homogeneous lean fuel-air mixtures. Lean-burn engines generally use around 100 % excess air (over-stoichiometric). Typical NO_x emission concentrations for lean-burn natural gas engines are between 90 mg/Nm³ and 380 mg/Nm³.

SG natural-gas-fired lean-burn engines used in 'optimised' gas mode (lowest fuel consumption, lowest unburnt emissions, high flue-gas temperature) achieve NO_x levels of 190 mg/Nm³ at 15 % O₂, and lean-burn DF engines achieve levels of 380 mg/Nm³ at 15 % O₂. SG engines and DF engines (in gas mode) can be tuned to achieve NO_x levels of respectively 95 mg/Nm³ and 190 mg/Nm³, with a higher fuel consumption and a lower flue-gas temperature as a consequence. Recently commissioned lean-burn SG engines (30–40 MW_{th}) in Italy, also fitted with SCR, achieve yearly average NO_x concentrations of 28 mg/Nm³. Furthermore, gas engines that reported data for the review of this document monitor their NO_x and CO emissions continuously.

An added performance advantage of lean-burn operation is the higher output and higher efficiency if the mixture is not too lean. Optimised lean-burn operation requires sophisticated engine controls to ensure that the combustion remains stable and that NO_x reduction is maximised, while minimising emissions of CO and VOCs.

Cross-media effects

Table 3.22 shows data for a large lean-burn natural gas engine that illustrates the trade-offs between control of NO_x emissions and efficiency. At the lowest achievable NO_x levels (45–50 ppmv), almost 1.5 percentage points are lost compared to full rated efficiency.

Table 3.22: Trade-offs between control of NO_x emissions and efficiency

Engine characteristic *		Low NO _x	High efficiency
Capacity (MW)		5.2	5.2
Speed (rpm)		720	720
Efficiency, LHV (present)		40.7	42.0
Emissions:			
NO _x	(gm/KWh)	0.7	1.4
	(ppmv at 15 % O ₂)	46	92
CO	(gm/KWh)	3.2	2.0
	(ppmv at 15 % O ₂)	361	227
NMHC	(gm/KWh)	0.9	0.6
	(ppmv at 15 % O ₂)	61	39
* Based on engine manufacturer's data – Wärtsilä 18V34SG pre-chamber lean-burn SG-type gas engine. NB: NMHC: Non-methane hydrocarbons. Source: [144, Eurovent 1998]			

A SG-type engine can be tuned to achieve NO_x emissions of 100 mg/Nm³ (15 % O₂), but this will incur higher fuel consumption and corresponding higher CO₂ emissions, as well as higher CO, NMVOC and formaldehyde emissions.

Technical considerations relevant to applicability

Applicable to new plants.

Further developments to try to further decrease the NO_x emissions based on this principle (called 'advanced lean-burn') showed NO_x reduction improvements but not yet for dual fuel (DF) engines. The flame front is less developed in SG engines (no pilot fuel injection) compared to DF engines (injection of pilot fuel) so, as a consequence, an SG engine can be more highly tuned for low NO_x than a DF engine. If an SG engine is tuned to burn too leanly, misfiring might occur and other emissions such as CO and HC might increase, fuel consumption may increase and the flue-gas temperature could drop (detrimental for CHP).

Economics

No information.

Driving force

Reduction of NO_x emissions.

Example plants

Plants 353 and 354.

Reference literature

[22, US-EPA 2008] [23, Finland 2012]

3.2.2.3.10 Water/steam addition

Description

Water or steam is used as a diluent for reducing the combustion temperature in combustion plants and the thermal NO_x formation, either by being premixed with the fuel prior to its combustion (fuel emulsion, humidification or saturation) or directly injected in the combustion chamber (water/steam injection).

Technical description

Water/steam addition can be performed either by the injection of a mixture of fuel and water or steam, or by the injection of water or steam through nozzles directly into the combustion chamber of gas turbines, engines or boilers. The evaporation or superheating of steam requires thermal energy, which is then not available to heat the flame. Thus, the flame temperature decreases and NO_x formation is also reduced.

Use in gas turbines

As can be seen from Figure 3.40, the emission reduction rate strongly depends on the amount of water or steam used. In order to reach high emission reduction rates, large amounts of water or steam are necessary; sometimes the amount of water or steam injected is higher than the amount of fuel burnt. A higher emission reduction rate can be achieved with water than with steam (for a given water/steam to fuel ratio), which can be explained by the fact that more energy is required to evaporate the water (in practice, approximately twice as much steam is necessary to achieve the same NO_x emission reduction). The steam or water needs to be injected at high pressures, usually 20 bar or greater.

A special variant of steam injection for gas turbines is the 'Cheng Cycle', described in Section 3.2.3.3, which has the dual environmental benefit of NO_x reduction and higher efficiency.

Use in engines

In combustion engines, direct water injection may be applied as an alternative to emulsified fuels. Depending on the engine type, up to about 40–50 % NO_x reduction is achievable. Direct water injection can only be applied in some liquid-fuel-fired engine types; this technique is used

in some shipping installations only. The fuel consumption increases and the amount of water needed depends on the NO_x reduction rate. This method requires greater modifications to the engine design, due to the need for an additional water injection system and supervision of this system. The amount of water that can be injected is independent of the fuel injection pumps, allowing larger quantities of water to be injected. Corrosion can occur on cylinder heads and pistons, thus increasing maintenance needs.

Injection of a fuel-water emulsion in engines: NO_x reductions can be achieved by adding fresh water to the fuel and emulsifying the mixture before supplying it to the engine. The fuel-water emulsion is injected through the existing injection pump. The quantity of water injected depends on the operating conditions. A programmed control unit manages the mixing procedure. This method brings the water to exactly where it is needed and optimises the amount of water injected. This amount is limited by the capacity of the engine's injection device. The inert gas effect of the water in the combustion chamber lowers the combustion temperature, which then reduces NO_x generation and the thermal load of the components in the exhaust gas flow. The associated fuel consumption penalty ranges up to a 1 % increase for each 10 % of the water injection (related to the fuel consumption). Different sources ([92, Freimark et al. 1990], [61, Commission 2006]) report achievable NO_x emission reductions of 20 % and up to 60 % depending also on the water to oil ratio. This solution might also influence the remaining harmful components in the diesel exhaust gas; reductions in unburnt emissions such as CO and HC have been reported when operating on gas oil using this method. The quality of the emulsion is important as vapour bubbles in the heavy fuel being reheated can damage the injection system.

Humid air injection in engines: Humid air injection mainly consists of a heat exchanger and humidification cell, which can possibly replace the intercooler in engines. Air which is relatively hot and dry is fed into the unit, where the water partly evaporates, reducing the scavenging air temperature. The air fed to the cylinder is nearly saturated in water vapour: the quantity of water absorbed by the engine is controlled by the scavenging air temperature, which depends mainly on the water temperature. With this method, a water quantity of about twice the corresponding fuel consumption can be absorbed by the engine. The use of seawater instead of treated water for such devices has been reported without negative effect, as regards the plant reliability. This point is particularly interesting for plants located in coastal areas, as the operating cost of such a system is reduced. According to experiences of using humid air injection in engines in France, the maintenance costs decrease, the combustion chambers are cleaner and the lubricating oil consumption decreases as well. A NO_x emission reduction of 70 % has been reported for a medium-speed engine, but a range from 60 % up to 65 % is more common according to industrial feedback.

A high NO_x reduction leads to higher emissions of unburnt compounds (CO, HC, smoke, etc.). Tests have shown that, in practical applications, NO_x reductions of up to 50 % are reasonable in order to have acceptable emissions of unburnt compounds. NO_x reduction is also associated with a beneficial temperature drop, the amount depending on the turbocharger pressure and on the amount of water vapour added to the combustion air. The air mass passed through the engine is slightly increased by the water vapour, but without any additional compression work being needed. Corrosion can occur on valves, pistons and air receivers, thus increasing maintenance needs and costs. Therefore, long-term tests are needed in order to estimate the effects of corrosion and possible remediation options.

Achieved environmental benefits

- Reduced NO_x emissions to air.
- Reduced unburnt compound emissions (injection of water-fuel emulsion).
- Increased energy efficiency in the case of gas turbines (Cheng cycle).

Environmental performance and operational data

NO_x emission reduction rates of between 60 % and 85 % can be achieved but without limiting CO. When CO emissions are kept under control, NO_x reduction rates of between 40 % and 60 % can be achieved.

NO_x emissions can be reduced to approximately 45–125 mg/Nm³ (at 15 % O₂) for a gas turbine and to 100–400 mg/Nm³ for boilers depending on parameters such as the plant size, the combusted fuel types and/or the combination of techniques implemented for NO_x reduction. The reduction rates by steam or water injection in the case of gas turbines are presented in Figure 3.40.

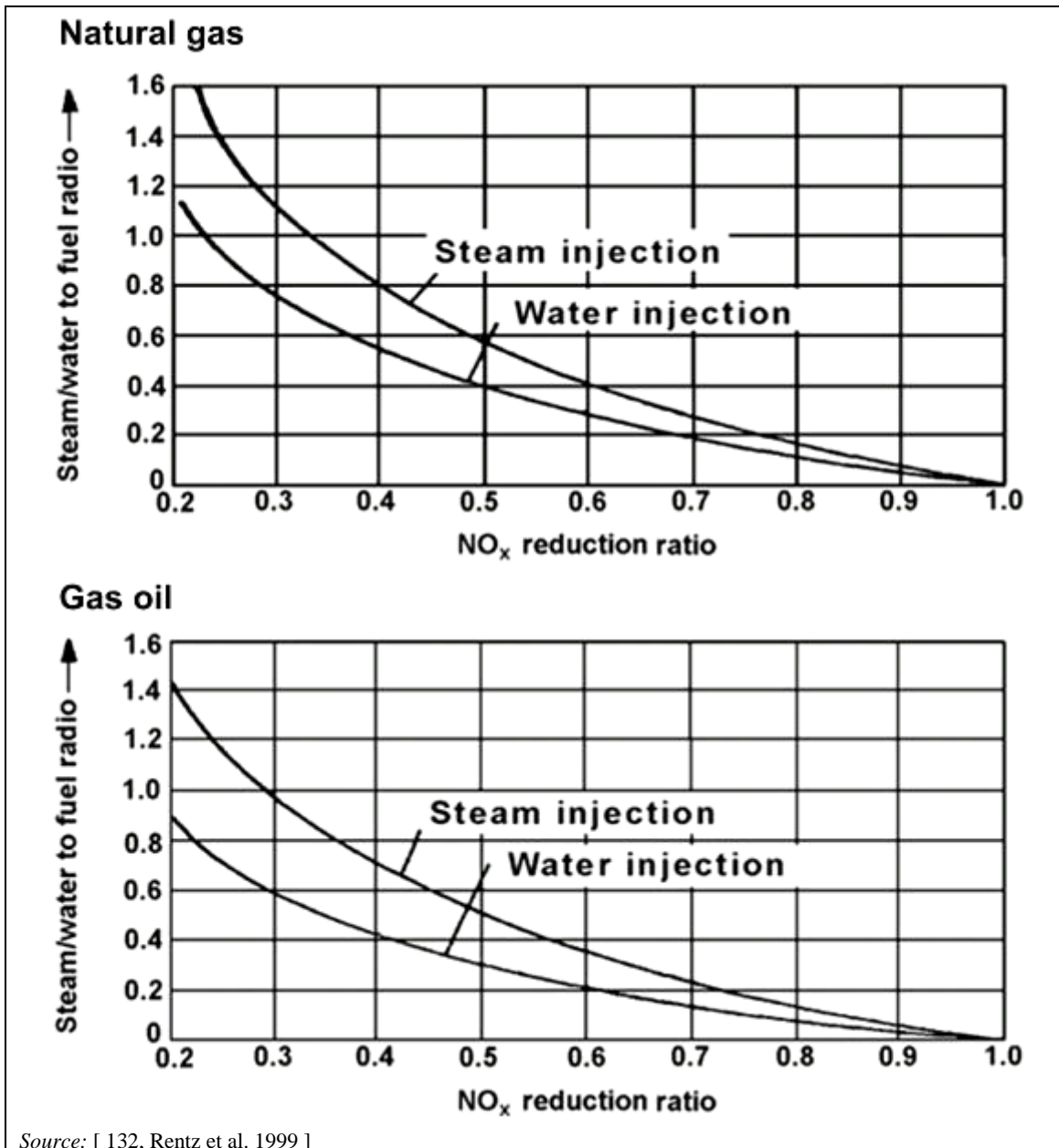

Figure 3.40: NO_x reduction by steam or water injection

For gas turbines, the steam/water to fuel ratio depends on the gas turbine type and varies between 1 and 2. The emission levels can vary a lot, depending on the load of the turbine. In many installations, the steam can only be produced in higher loads, which means that emissions will be only reduced after this baseload level has been reached. This makes steam injection of little use for gas turbines with lots of load changes.

The injection of water or steam to reduce NO_x can only be carried out to a certain limit. If the flow rate of the steam injected into the fuel burner is too high (typically the gas turbine supplier fixes a limit on the steam flow rate / fuel gas flow rate of 1.2), the effects on the compressor are relevant. The amount of steam (or water) can also negatively affect the combustion chamber (burners, flow sleeves, liners, transition pieces), with particular effects on lifetime and the risks of failure and damage to the downstream turbine section. In addition, the increase of water concentration in the exhaust flow from the combustion chamber to the turbine section has an impact on the integrity of the blades and nozzles. In fact, the heat exchange coefficient from the exhaust flow to the surface of the nozzles or blades is proportional to the water concentration, so if the gas turbine runs with a large amount of steam or water in order to control the NO_x, mechanical damage and an efficiency reduction may occur, increasing the maintenance costs and the risk of failure.

Table 3.23 gives levels of NO_x and CO emissions recorded for example European gas turbines in 2011.

Table 3.23: NO_x and CO emissions from applying water or steam injection to example gas turbines

	Measured emission values (yearly average)
CO (mg/Nm ³)	2–80
NO _x (mg/Nm ³)	45–125
<i>Source: LCP TWG - 2012</i>	

Cross-media effects

Some major drawbacks of this NO_x abatement technique are the increased emissions of CO and hydrocarbons, a potential decrease in the thermal efficiency of the installation, and an increase in fuel consumption. CO catalyst can be installed to oxidise the CO to CO₂. Steam or water injected into gas turbines needs to be of a very high purity, and therefore application of this technique requires the use of a high-quality water treatment plant, which in turn may create a liquid effluent requiring disposal. Steam injection causes a greater efficiency loss than water injection (3–4 % for water injection). Furthermore, flame stability problems can be observed at high water to fuel ratios and direct injection of water or steam results in a higher material stress (small fissures can occur on the material surface due to temperature shock) than injection of a fuel and water or steam mixture. As a consequence, the latter alternative is often preferred. [132, Rentz et al. 1999]

The use of steam or water injection may also reduce the life expectancy of a gas turbine.

Technical considerations relevant to applicability

This technique can be applied to new and existing gas turbines, or to boilers generally combusting liquid fuels, alone or in combination with other techniques reducing NO_x emissions.

Water injection has often been used when steam was not available, e.g. in simple cycle applications, whereas steam injection is usually preferred in natural-gas-fired combined cycles, where steam is readily available from the exhaust heat recovery system.

Nowadays, new gas turbines are built with dry low-NO_x combustors, and most existing plants can be retrofitted with such combustors, providing a better performance than water/steam injection. However, for certain small or existing turbines, water/steam injection may be a cost-effective solution.

There may be technical constraints to retrofitting water/steam addition in existing old engines. For the fuel-water emulsion technique, major modifications have to be made to the fuel

injection system (FIE) of an existing engine since the thermal input to the engine will be reduced and thus higher mass flow rates of emulsions will be required.

The applicability may be limited in the case of engines where a retrofit package is not available.

The technique cannot be applied in areas with a shortage or lack of water since the water consumption requirements are high.

Economics

The investment costs for retrofitting gas turbines with water or steam injection can vary widely. These costs are mainly related to the water conditioning and injection devices used. The additional operating costs incurred by the water/steam injection are due to increased fuel consumption.

A steam injection retrofit for a 140 MW_{th} gas turbine costs about EUR 1.7 million.

The injection of water or steam requires the preparation of the water used for the process. At sites where steam or water is not used for other requirements, the investment and operational costs are high. In the cases where gas compressor stations – with a size capacity of between 20 MW_{th} and 250 MW_{th}, with changing operating conditions and with low operating hours per year – are situated at remote sites, the total costs are high. Furthermore, for existing gas turbines, the conversion of the combustor of a gas turbine to a steam or water injection system requires changes to the design and the layout of the gas turbine.

Driving force for implementation

Reduction of NO_x emissions.

Example plants

Plants 70, 71, 102, 153-1/3, 174, 295, 296, 360, 375 and 488.

Reference literature

[167, Austrian Ministry of Environment 2000] [132, Rentz et al. 1999] [198, OSEC 1999]

3.2.2.3.11 Selective catalytic reduction (SCR)

Description

Selective reduction of nitrogen oxides with ammonia or urea in the presence of a catalyst. The technique is based on the reduction of NO_x to nitrogen in a catalytic bed by reaction with ammonia (in general aqueous solution) at an optimum operating temperature of around 300–450 °C. Several layers of catalyst may be applied. A higher NO_x reduction is achieved with the use of several layers of catalyst. The technique design can be modular; a special catalyst and/or preheating can be used to cope with low loads or with a wide flue-gas temperature window.

Technical description

The reducing agent is injected into the flue-gas upstream of the catalyst. NO_x conversion takes place on the catalyst surface at a temperature usually between 300 °C and 450 °C, and sometimes in wider range between 170 °C and 510 °C depending on the type of catalyst/configuration used, by one of the main reactions below. Base metal oxide SCR catalysts operating in the above-mentioned temperature range are available on the market and used in numerous applications.

1. With ammonia as a reducing agent:

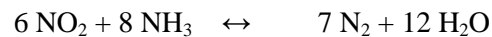

2. With urea as a reducing agent:

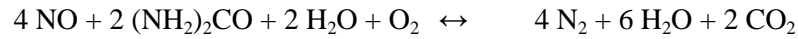

When ammonia is used as the reducing agent, it is usually stored in vessels as an aqueous solution or in a liquefied state (anhydrous ammonia) at a pressure greater than its vapour pressure (about 17 bar) at the maximum temperature. In some smaller applications, i.e. $< 50 \text{ MW}_{\text{th}}$, urea is used in the form of white crystal granules, which are dissolved in water before being injected.

The number of installations using liquefied ammonia exceeds the number of installations using other agents, because the cost per kg of ammonia is lower, thus allowing low operating costs. Investment costs for ammonia storage, including safety measures, are also lower. Nevertheless, its properties make handling more difficult compared to the relatively inert aqueous ammonia solution.

To use, liquefied ammonia has to be evaporated to gaseous ammonia. This is achieved in an evaporator heated electrically, by steam, or by hot water. The ammonia is subsequently diluted with air before the mixture is injected into the exhaust gas. The injection takes place through a system of nozzles to achieve a homogeneous mixing of ammonia with the flue-gas. A static mixer can be placed in the exhaust gas channel to further improve mixing. In order to obtain a high NO_x removal efficiency and to minimise the NH_3 slip, it is particularly important to achieve a homogeneous NH_3 to NO_x ratio in the flue-gas. Even in the absence of specific emission limit values for ammonia, a strong motivation for avoiding ammonia slip (over 2 ppm) in coal-fired combustion plants is that otherwise the fly ash cannot be sold to the building industry.

The degree of NO_x removal depends on the catalyst used: at high NH_3 to NO_x ratios, a high NO_x removal efficiency can be obtained, but simultaneously the amount of unused ammonia (NH_3 slip) in the clean flue-gas increases considerably. The ammonia slip should be as low as possible, in order to avoid the risk of NH_3 reacting with SO_3 in the flue-gas during cooling of the flue-gas, which can lead to fouling and corrosion of the heating surfaces by the ammonium bisulphates ($(\text{NH}_4)\text{HSO}_4$ or 'ABS') formed.

The catalysts used can have different geometrical forms such as the honeycomb, plate or corrugated types shown in Figure 3.41. Pellets (especially for activated carbon) are also used in some applications.

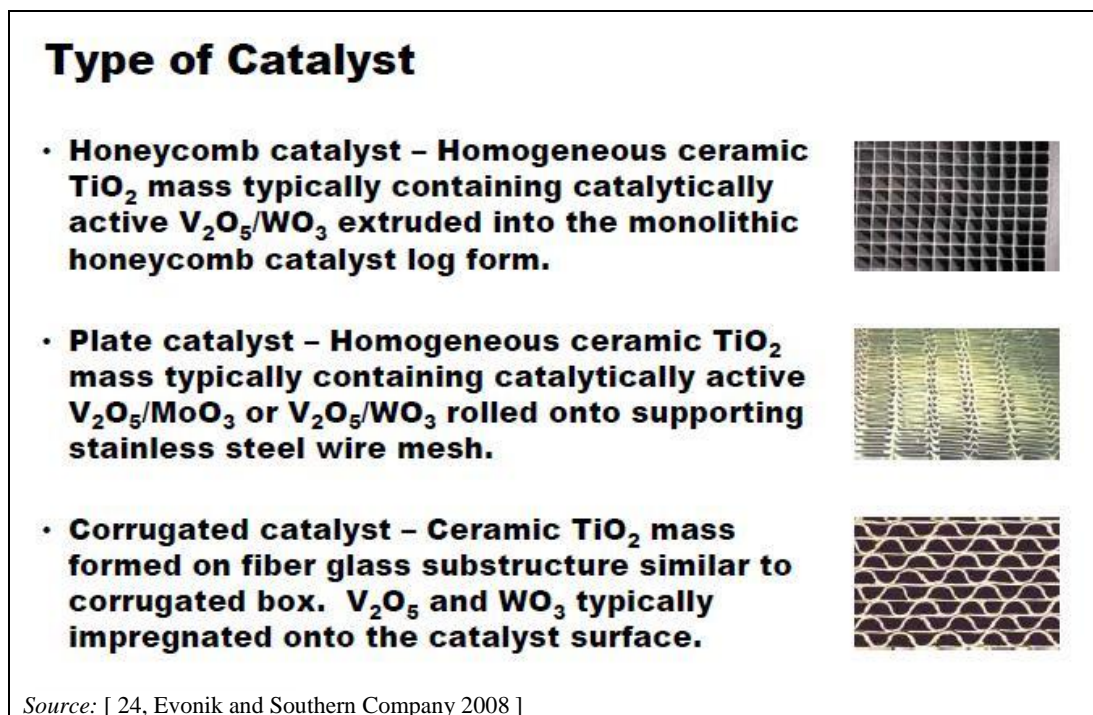

Figure 3.41: Different types of catalysts

The main materials used as catalysts in SCR are as follows:

- **Base metal oxides**, which consist of the base material TiO_2 together with the active components vanadium, tungsten and molybdenum. In most cases, V_2O_5 is used with small amounts of WO_3 added in order to extend the narrow temperature window, and small amounts of SiO_2 in order to stabilise the structure, and small amounts of MoO_3 in order to make the catalyst more resistant to poisoning from exhaust gas constituents. This type of catalyst requires a temperature range of 300–450 °C.
- **Zeolites**, which are crystalline, highly porous natural or synthetic aluminosilicates, and are used at temperatures between 350 °C and 600 °C.
- **Iron oxides**, which consist of iron oxide particles with a thin crystalline cover of iron phosphate.
- **Activated carbon**, which consists of either pulverised coal or lignite, is mixed with inert elements and worked into sintered pellets. Due to the thermal instability of activated carbon at higher temperatures, low operating temperatures of 100–220 °C are required. As a result, in power stations, activated carbon can only be employed in the ‘tail-end’ configuration.

Catalysts are manufactured in a number of different channel diameters. The choice of channel diameter is optimised after a study of the dust content in the exhaust gas, the characteristics of the dust, and the allowable pressure drop across the SCR reactor. The deposit of dust should be minimised and the pressure drop over the catalyst kept low. The volume of catalyst required depends on the characteristics of the catalyst, such as its activity characteristics, and on the operating conditions, such as flue-gas volume, the required NO_x reduction, gas composition, flue-gas temperature and the presence of catalyst poisons. The individual catalyst elements are packed together in a catalyst module, which then forms the catalyst layers in the SCR reactor, as can be seen in Figure 3.42.

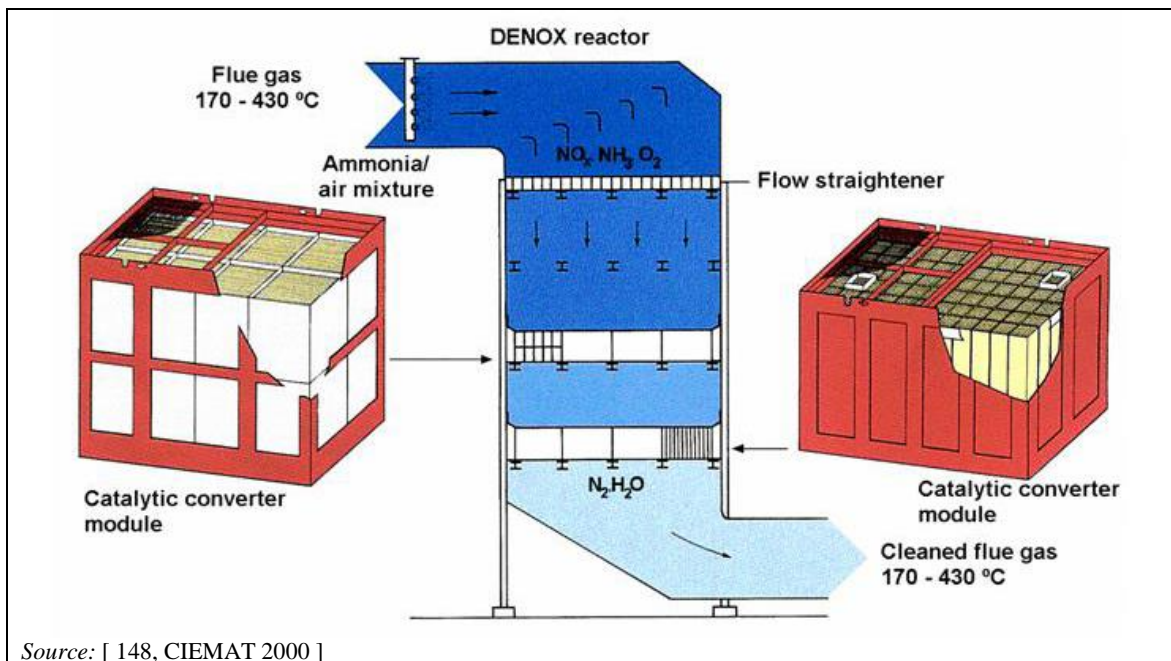

Figure 3.42: Configuration of catalytic reactor

The catalyst lifetime usually ranges from 3 to 7 years in coal-fired units and from 8 to 12 years in oil- and gas-fired units, depending on the load mode (50 000–60 000 hours of operation). These general figures may differ depending on several site-specific factors, such as equipment type, fuel characteristics, capacity, plant operation, inlet NO_x concentration, NO_x reduction rate, ammonia/urea to NO_x ratio, and allowable ammonia slip. In recent years, catalyst formulations more resistant to thermal and mechanical damage and to poisoning from contaminants have been commercialised. The latest developments in regeneration techniques and catalyst management now alternatively allow the regeneration of each catalyst layer, replacing them with new catalyst layers only after four regenerations, corresponding to a 20-year life cycle, thus reducing the operational cost of SCR implementation by almost 40 % [24, Evonik and Southern Company 2008]. It is now standard practice to leave space in the casing for a spare catalyst layer that can be brought into use to supplement the performance of catalysts as their effectiveness starts to fall over time. In this way, maximum use of existing catalysts is obtained before they are sufficiently depleted to require regeneration or disposal.

There are three basic configurations for integrating the SCR reactor into the flue-gas cleaning chain, the main factor being that the conditions, such as flue-gas temperature, are right for the catalyst used. The positions that are utilised for the catalyst are shown in Figure 3.43.

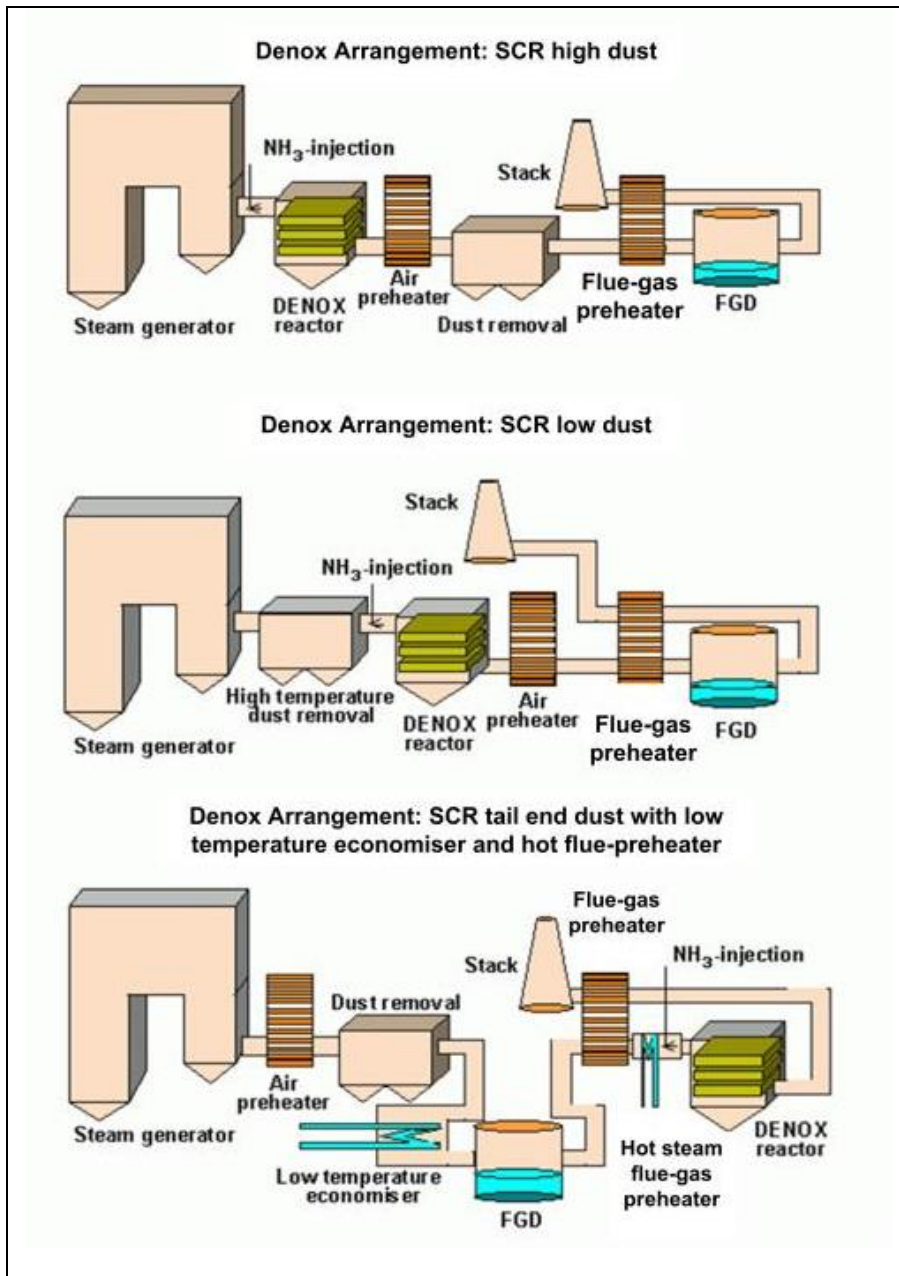

Figure 3.43: Existing configurations of SCR NO_x abatement techniques

The three configurations are high-dust, low-dust and tail-end:

- The **high-dust** arrangement is the most commonly implemented and avoids the flue-gas reheating due to the high operating temperature of the catalyst (Figure 3.44). The lifetime of the catalyst has been improved, as well as its resistance to abrasion. However, its use has two drawbacks: first, the flue-gas may contain fly ash and catalyst poisons, which results in catalyst deactivation, followed by a decrease in NO_x reduction efficiency. This may occur, for example, in slag tap furnaces, for specific fuels or in co-combustion processes. Secondly, for retrofitting with SCR in the high-dust configuration, additional space is required near the boiler. The high-dust arrangement is cost-effective for many installations.
- In-duct SNCR/SCR, also called slip, catalyst or hybrid SNCR/SCR, is a version of the high-dust arrangement. These catalyst systems are combined with SNCR in order to consume the remaining injected sorbent still present in the flue-gas at the boiler outlet in order to add a NO_x reduction stage. Such SCR requires much less catalyst than

conventional SCR, providing overall high removal efficiency and low ammonia slip at a reduced capital cost.

- The **low-dust** arrangement bypasses the drawbacks of the high-dust configuration. Its major advantage is the lowered mechanical strain on the catalyst, which can be expected to extend the catalyst's lifetime. However, because the process operates without supplementary heating, the installation of high-temperature dust precipitators is necessary. Therefore, this configuration often proves to be uneconomical when retrofitting old power plants. Moreover, the air heater is subject to the deposition of ammonium bisulphate.
- The **tail-end** arrangement is a favourable variant for existing plants, due to the reduced exposure of the catalyst to abrasion, corrosion, and deactivation. Also, the catalyst volume is smaller than for the high-dust configuration, because a catalyst with a smaller pitch can be used. However, the incoming flue-gas has to be reheated by additional burners that mainly use natural gas to reach the operating temperature of the catalyst. For an activated coke catalyst, a heat exchange from the raw gas to the clean gas is usually sufficient.

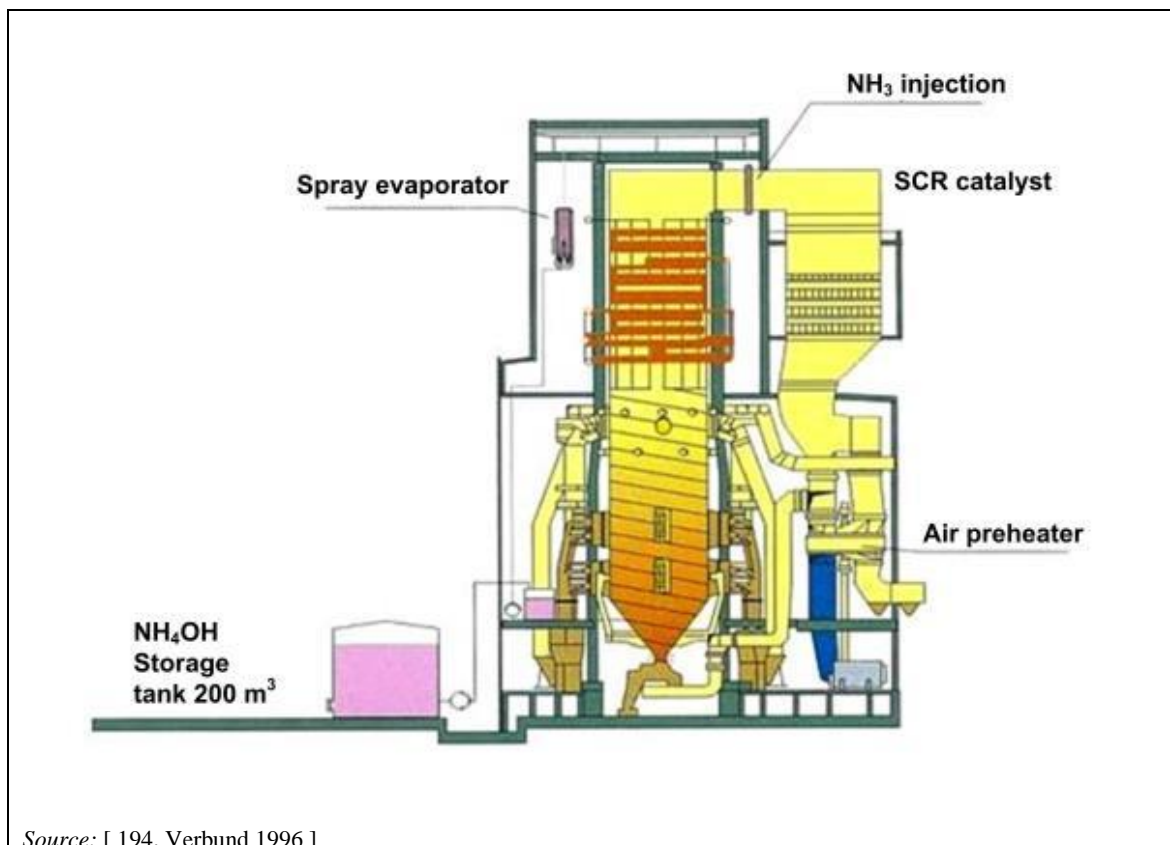

Source: [194, Verbund 1996]

Figure 3.44: Example of a high-dust SCR catalyst

In utility boilers, the SCR catalyst is normally placed between the economiser and the air preheater (high-dust configuration) to achieve the required temperature window whilst minimising costs compared to a tail-end arrangement. The catalyst can be protected however by using a bypass for start-up and shutdown. Newly built SCR systems no longer have a bypass.

Tail-end configurations in which the catalyst is placed downstream of the air preheater require the flue-gas to be reheated to the catalyst operating temperature and are, therefore, more expensive to build and operate. Required SCR retrofit components include the SCR reactor, associated ducting and structural work, the ammonia storage and distribution system, and

controls. Other components which may be necessary include an economiser bypass and soot blowers. Whilst high-dust SCR systems are generally more economical, there may be situations where site constraints favour a tail-end arrangement. The choice of catalyst type and characteristics depends on the ash mass flow and its erosive potential (plate type, honeycomb type). High dust loadings therefore require catalysts with high plugging and abrasion resistance. Medium-pitch honeycomb SCR catalysts are favoured for low-dust applications where nearly all the fly ash has been removed from the flue-gas. The increased surface area resulting from the use of medium-pitch honeycomb SCR catalysts in low-dust applications results in lower catalyst volume requirements compared to high-dust applications.

The issues of combustion process type and fuel composition factor significantly into the catalyst design and must be specifically considered for each individual plant. Slag tap (WBB) furnaces with fly ash recirculation generally show a higher catalyst deactivation rate than dry-bottom boilers. Coals high in arsenic, alkali or alkaline earth metals, phosphorus, calcium and a number of other compounds, or biomass fuels with high levels of alkali, show higher catalyst deactivation behaviour, which must be taken into consideration when catalyst lifetime and loading volumes are calculated. The sulphur content in the fuel is also examined to determine an appropriate SO_2 to SO_3 conversion rate for the SCR catalyst and to establish a minimum operating temperature at which the formation of ammonium bisulphate can be avoided. The catalyst's minimum operating temperature depends on the concentration of SO_3 . Excess NH_3 reacts with SO_3 , forming ammonium salts $(\text{NH}_4)_2\text{SO}_4$ and NH_4HSO_4 that condensate and block the catalyst openings. SCR catalysts exist for a lower temperature range (below 290°C), but can only be used when the SO_x in the flue-gas is below 50 mg/Nm^3 . (It is generally estimated that SO_3 makes up roughly 3–5 % of total SO_x) (see also the paragraphs below on SO_2 to SO_3 conversion and on ABS).

The catalyst lifetime can be optimised through proper maintenance, including the use of appropriate soot blowing and by avoiding contact with moisture for catalysts exposed to fly ash. System bypasses can be used when the unit is starting up or shutting down or if the economiser temperature drops below the minimum catalyst operating temperature at low combustion plant load. When using a conventional SCR system with a diesel engine, for example, the range of load in operation is limited to approximately the upper third.

The main advantages of the SCR technology are:

- the SCR process can be used for many of the fuels used in combustion processes, e.g. natural gas and light oils, as well as process gases and coal;
- the conversion of NO_x does not create any secondary pollution components;
- the emission of NO_x can be reduced by 90 % or more;
- the overall NO_x reduction depends on SCR and primary measures;
- to meet air quality requirements, SCR can be applied with adapted NH_3 consumption to reduce NH_3 slip effects and to increase catalyst lifetime.

Achieved environmental benefit

- Reduced NO_x emissions to air.
- Reduced mercury emissions to air due to greater oxidation of elemental mercury.

Environmental performance and operational data

There are no major problems in designing SCR for boilers and engines (see example in Figure 3.45) with 90 % or higher NO_x reduction. For higher reduction rates, a more sophisticated control system is needed in order to keep the SCR in the optimal working area. Fuel impurities have a direct impact on achievable reduction rates; with clean fuels, higher NO_x reduction rates can be achieved. Special care is taken in the design of the NH_3 injection system to ensure a uniform NH_3 to NO_x ratio in the flue-gas. The increased NO_x reduction requires 5–10 %

additional installed catalyst and a corresponding higher pressure drop. Also, a slightly higher NH_3 slip is expected due to the increased reagent injection needed at higher NO_x reduction rates.

In gas turbines, it is more difficult to obtain a very uniform NH_3 to NO_x ratio in the flue-gas. However, a 95 % reduction rate may be obtained with 5–10 ppm NH_3 slip [25, Haldor Topsoe 2012], [98, EUROMOT 2013], [89, EPPSA 2013]. Retrofitting a CCGT requires a catalyst volume of $0.2 \text{ m}^3/\text{MW}_e$ (e.g. about 80 m^3 for a 400 MW_e plant). [116, EUTurbines 2013]

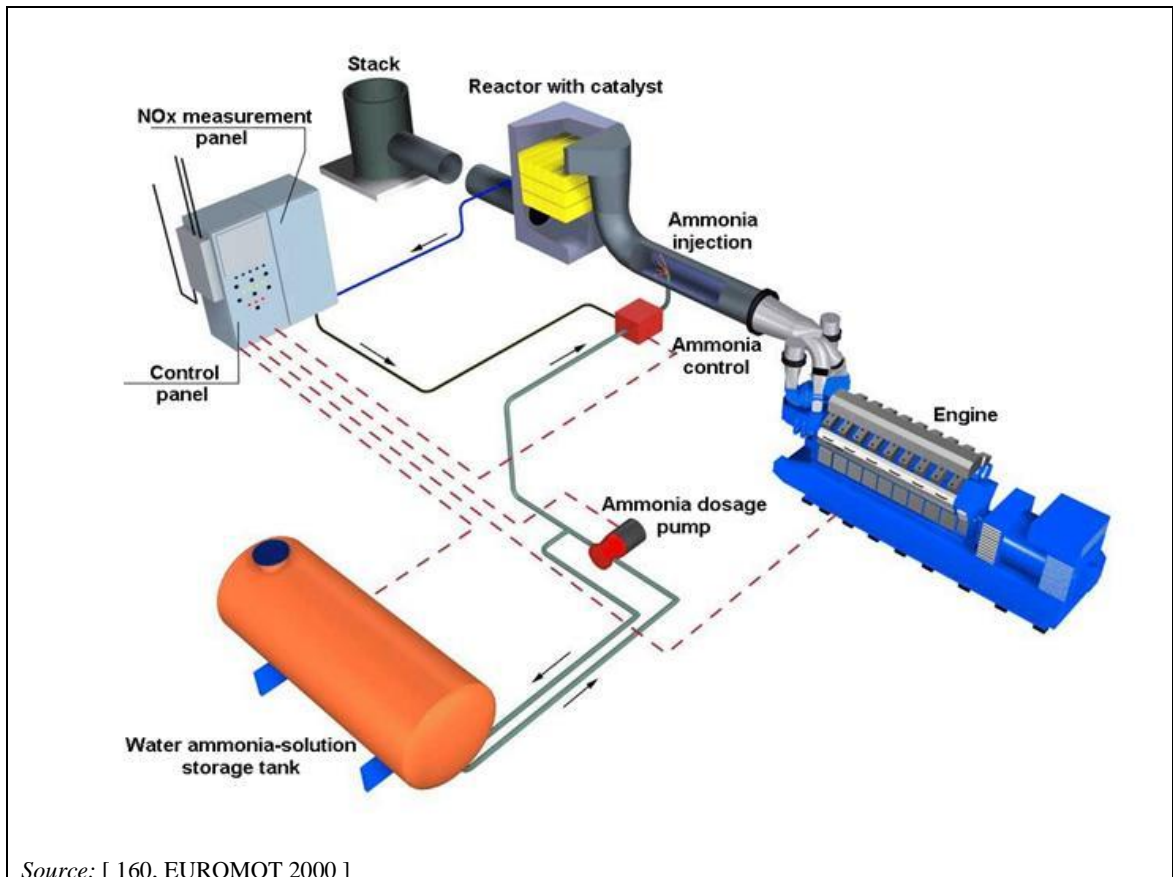

Source: [160, EUROMOT 2000]

Figure 3.45: SCR system applied to a stationary combustion engine

The SCR system's ability to respond to load changes depends not only on the control system but also on the design of the catalyst implemented in the system. Older systems have a tendency to emit excessive NH_3 and NO_x during load changes but modern catalyst types with lower mass react faster to changes in operating conditions and enable rapid system start-up and achievement of stable performance. [25, Haldor Topsoe 2012]

Catalyst bed pressure drop is monitored to detect any sign of fouling as catalyst fouling increases back pressure and reduces activity. Fouling can occur from:

- burning dirty fuel;
- sulphate deposition;
- excessive fuel-rich operation.

Operators report that catalyst plugging with solids is the most frequent operational issue. Solids in the flue-gas duct from corrosion, duct insulation degradation, etc. plug the SCR catalyst openings, causing excessive pressure drop and unit shutdown for cleaning.

Examples of typical emission data at a 100 % plant load are given in Table 3.24.

Table 3.24: Typical SCR efficiencies for different combustion processes (dependent on SCR design and injected reagent amount)

Application	NO _x inlet (ppm)	NO _x outlet (ppm)
Power plant – coal-fired	500	40–50
Gas turbine	25–90	2–9
Diesel engine	1 200	120
<i>Sources: [25, Haldor Topsoe 2012] [181, CEFIC 2013]</i>		

At lower loads, the NO_x reduction rate is equal to or better than at 100 % load, due to the lower flue-gas flow rate (higher relative amount of catalyst).

Table 3.25 presents the efficiency and operational parameters when applying SCR.

Table 3.25: Performance of the SCR technique for reducing nitrogen oxide emissions

General NO _x reduction rate	Operating temperature	Configuration/plant
80–95 %	350–450 °C	High-dust
	170–300 °C	Tail-end
	280–510 °C	Gas turbines
	200–510 °C	Diesel engines
NB: The life of the catalyst is 3–7 years for coal combustion, 8–12 years for oil combustion and more than 10 years for gas combustion. Catalyst regeneration allows a catalyst lifetime of about 20 years. A catalyst lifetime of 40 000–80 000 operating hours can be reached by periodical washing. However, it can be much shorter in aggressive conditions (e.g. with difficult biomasses, the chemical lifetime may be as low as 8 000 operating hours). Operating temperatures are dependent on the fuel sulphur content. The catalyst performance tends to deteriorate with time.		

Cross-media effects

- The ammonia slip increases with an increasing NH₃ to NO_x ratio, which may cause problems, e.g. with an excessively high ammonia content in the fly ash. This is a problem which can be solved by using a larger catalyst volume and/or by improving the mixing of NH₃ and NO_x in the flue-gas.
- Incomplete reaction of NH₃ with NO_x may result in the formation of ammonium sulphates, which are deposited on downstream systems such as the catalyst and air preheater; increased amounts of NH₃ in flue-gas desulphurisation waste waters and the air heater cleaning water; and an increased NH₃ concentration in the fly ash. This incomplete reaction only occurs in the very unlikely case of catastrophic failures of the whole SCR system.

SO₂ to SO₃ conversion

As a result of the fossil fuel combustion process, SO₂ and SO₃ are generated due to the presence of sulphur in the fuel. The use of SCR systems for NO_x emission control can have a negative impact on the concentration in the flue-gas at the air preheater and through the stack. This is caused by the undesired oxidation side reaction:

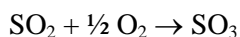

Higher levels of SO_3 can cause operational issues related to air preheater fouling and/or corrosion and may lead to more visible emissions due to sulphuric acid mist. SO_3 stack emissions below 5 vppm avoid visual emissions.

Catalyst manufacturers typically formulate their catalyst to achieve a low SO_2 to SO_3 oxidation level. Therefore, the reaction is relatively slow compared to the NO_x reduction reaction.

[27, ICAC 2009]

ABS formation

Operating at low load can cause problems with maintaining the minimum temperature, and ammonium bisulphates $(\text{NH}_4)\text{HSO}_4$ (ABS) may condense and form a sticky coating on the catalyst and plume at the stack. ABS is a highly acidic and sticky substance that can deposit on downstream equipment such as convection coils and air heaters, causing plugging and a deterioration in equipment performance. Fly ash will be caught and the canals in the catalyst can be blocked. ABS can, because of the capillary effect, condense in the pores of the catalyst approximately 28 °C above the temperature of condensation on the surface of the catalyst. When the temperature rises again ABS will then evaporate, but if the SCR system is in operation below the dew point of ABS for a longer period the catalyst will gradually deactivate, with decreasing efficiency or ammonia slip as a consequence. Deposits can be minimised by keeping ammonia slip low and monitoring the flue-gas temperature downstream. Deposits can be cleaned on-line by water washing or by raising metal temperatures above the condensation temperature to sublime deposits with suitably designed materials. In Denmark, coal-fired power plants with SCR equipment have very different levels of ammonia injection for the minimum load (approximately 20 % to 50 % of the maximum load), where the ammonia dosage is either decreased or stopped.

Other effects

The flue-gas pressure drop through the catalyst can generally vary from 5 mbar to 15 mbar. Additional energy may be needed to offset this pressure drop. Furthermore, in the tail-end arrangement, reheating may be needed for the catalyst to reach the minimum operating temperature.

This technique generates waste (spent catalyst).

Catalyst washing may generate effluents not typical of those expected at the installation and may thus require the adaptation of the waste water treatment or washing on specialised companies' premises.

Other cross-media effects are linked to the use of ammonia, through:

- the release of NH_3 to air in the case of inhomogeneous reactions between NO_x and NH_3 ;
- safety issues related to ammonia storage.

(See further details in Section 3.2.2.3.13.)

Technical considerations relevant to applicability

The technique is applicable to new plants.

Retrofitting SCR to existing plants requires consideration of space, pressure and temperature constraints. Higher operating temperatures reduce the catalyst size and costs but introduce retrofit complexity. Lower operating temperatures increase the required catalyst volume and costs but often allow for a simpler retrofit.

Load variations and frequent start-ups/shutdowns may limit the use of conventional SCR as high variations of the load demand can make the flue-gas temperature very unstable and not always compatible with the temperature window of available catalysts. This may require specially designed catalysts and/or a preheating system.

Economics

The investment costs of an SCR device are considerable (Figure 3.46). The price per tonne of NO_x reduced varies between plant types. Tangentially fired boilers have higher costs per tonne of NO_x reduced than wall-fired boilers because they have lower original emission levels. The reactant costs are relatively lower than in the SNCR plants.

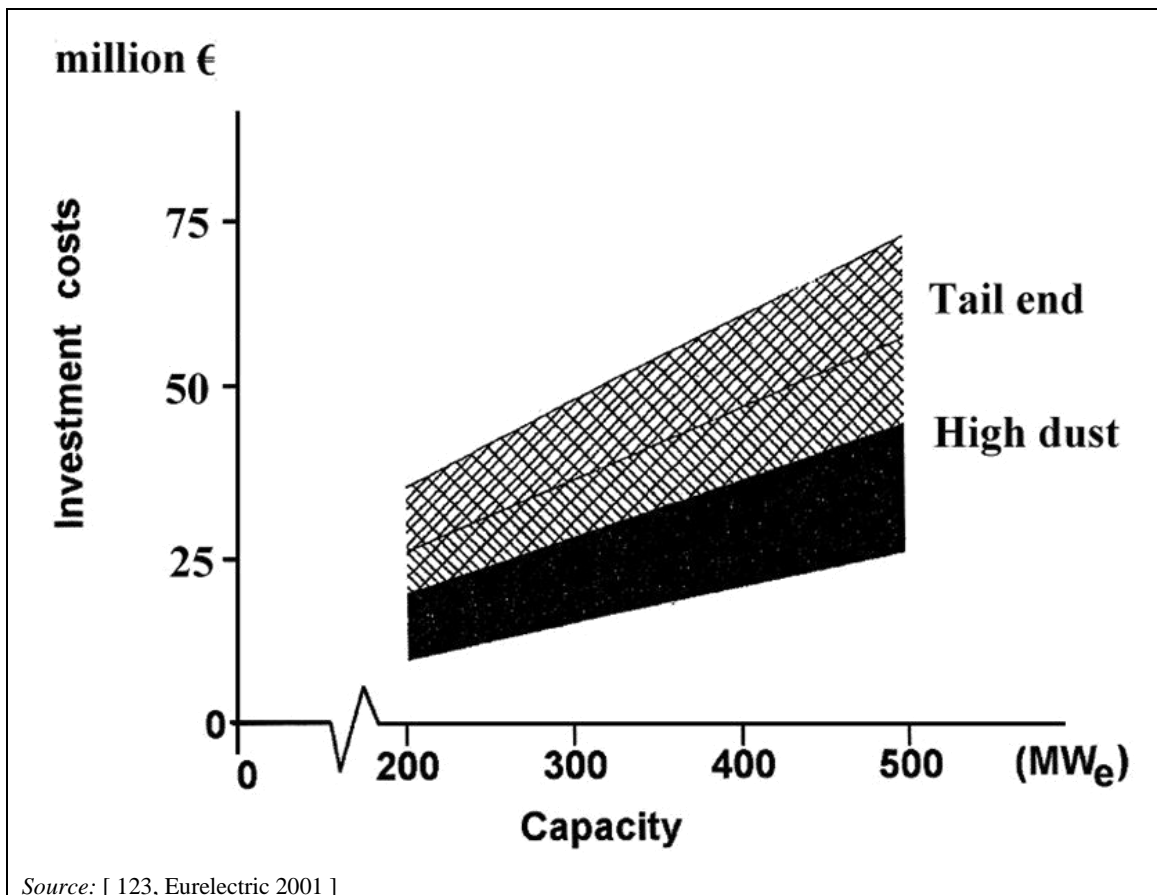

Source: [123, Eurelectric 2001]

Figure 3.46: Investment costs for an SCR process at a combustion plant

The investment costs of an SCR unit depend on the volume of the catalyst, which is determined by the flue-gas volume, by the ammonia slip, and by the NO_x conversion rate which should be attained. In cost estimations carried out for power plants, costs for catalyst were estimated to be in the range of EUR 5 000–10 000 per m³ [25, Haldor Topsoe 2012], [116, EUTurbines 2013]. For a given flue-gas volume of 1 million m³/h, investment costs for an SCR unit were estimated to be EUR 15 million (raw dust arrangement; including planning, erection and all surrounding equipment such as pipework, pumps and fans, but without the catalyst). The main factors for operating costs are the lifetime of the catalyst, which is influenced by the fuel characteristics and the SCR configuration (low-dust, high-dust, tail-end); the volume of reduction agent required; energy consumption due to pressure loss; and finally energy for reheating of the flue-gas.

On the basis of operators' information and 2000–2005 market prices (Austrian and German plants), the investment costs for an SCR unit were estimated using the following formula:

Investment cost (I.C.) for an SCR unit treating a flue-gas volume of x million m³/h:

$$\text{I.C.} = (x \text{ million m}^3 \text{ flue-gas volume} / 1 \text{ million m}^3)^{0.7} * \text{EUR 15 million}$$

Costs for erection and for electronic monitoring and control equipment are included. Costs for catalysts are excluded but are estimated to be in the range of EUR 15 000/m³. Costs were estimated for the raw gas arrangement only. The main cost factors amongst investment and

maintenance costs are costs for catalyst displacement, the reduction agent (aqueous solution of ammonia) and electric energy. In the investment costs, costs for the whole flue-gas channel are included (pipes, catalyst box, bypass and the NH_4OH unit consisting of a tank, storage system, dosing device, evaporation and mixing system).

In Table 3.26, costs were estimated for an SCR unit treating flue-gas volumes of 200 000 m^3/h , 500 000 m^3/h and 1 000 000 m^3/h with a raw gas concentration of 500 mg/Nm^3 (attained by primary measures) and 350 mg/Nm^3 (attained by primary measures and SNCR). The clean gas concentration is, in both cases, assumed to be 100 mg/Nm^3 .

Table 3.26: Cost estimations for an SCR unit as a function of the flue-gas volume for a coal-fired boiler

Parameter	Unit	Flue-gas volume (Nm^3/h)		
		200 000	500 000	1 000 000
NO_x concentration to be reduced	g/Nm^3	NA	0.25–0.4	0.25–0.4
Operating hours	h/yr	5 000	5 000	5 000
Reduced load	t/yr	250–400	625–1 000	1 250–2 000
Investment costs	million EUR	4.86	9.23	15.0
Yearly repayment ⁽¹⁾	million EUR/yr	0.50	0.95	1.54
Operating costs (including costs for electric energy, catalysts, reducing agents, maintenance, and wear and tear)	million EUR/yr	0.25–0.29	0.60–0.69	1.17–1.34
Yearly costs	million EUR/yr	0.75–0.79	1.56–1.64	2.72–2.88
Specific NO_x removal costs	EUR/t NO_x	1 968–3 016	1 638–2 488	1 442–2 175
⁽¹⁾ Basis: 15 years with a 6 % interest rate.				
NB:				
NA: Not available.				

With tail-end devices, the flue-gases may have to be reheated before the stack. This may take up as much as 2 % of the electric capacity of the plant. In applications which do not need reheating, the operating costs are mainly related to the cost of the reagent.

System capital costs for retrofit applications removing between 60 % and 90 % NO_x range between EUR 50/kW and EUR 100/kW, where the costs for larger plants are at the lower end of this range and the costs for smaller plants at the higher end. The main factors contributing to full retrofit costs for SCR systems in coal plants with a target NO_x emission level of 185 mg/Nm^3 are unit size, inlet NO_x concentration and the varying construction needs associated with the level of retrofit difficulty. For instance, an increase in baseline inlet NO_x concentration from 615 mg/Nm^3 to 1 230 mg/Nm^3 will increase the SCR capital costs by around 50 %. As the unit size decreases from 1 000 MW_e to 200 MW_e the initial SCR capital cost can decrease by up to 30 %. The scope of retrofit for fan upgrades, ductwork, structural steel and foundation changes can impact costs by around 20–35 %. Operating costs for the reducing agent are approximately EUR 75 per tonne of NO_x for anhydrous ammonia or EUR 125 per tonne of NO_x for a 40 % urea solution. Overall costs, i.e. investment and operating costs, for NO_x reduction in an 800 MW power plant using SCR range between EUR 1 500 and EUR 2 500 per tonne of NO_x reduced. [164, Rigby et al. 2001]

The capital costs of an SCR system for gas turbines or internal combustion engines are in the range of EUR 10–50/kW (based on electrical output). These costs are considerably lower than for the application of an SCR system to a coal-fired plant. This is also the case when comparing the yearly specific costs including the operational costs (e.g. about 700 EUR per tonne of NO_x

abated, estimated in a mainland example engine sized 20–50 MW_{th} and operated 4 000 h/yr with an SCR system with a 75 % removal efficiency). However, when considering the cost in EUR/MWh_{el}, the NO_x abatement cost of the SCR system is about three to nine times higher for a stationary diesel engine plant than for a coal plant due to the initial higher level of NO_x to abate. [98, EUROMOT 2013]

Examples of capital costs for a two-layer SCR catalyst achieving removal efficiencies between 85 % and 95 % for gas/liquid-fired boilers used in the chemical industry are in the range of EUR 30–50/kW_{th}, with annual operating costs of about EUR 50 000/yr and costs associated to the catalyst replacement ranging between EUR 75 000/yr and 250 000/yr. [3, LCP TWG 2012]

There are different processes available today for the regeneration of used catalysts, which can increase the catalyst lifetime considerably and which, therefore, reduce the operating costs. The price of regenerated SCR catalysts is up to half that of new catalysts. Without severe erosion effects, the limited lifetime of deactivated high-dust SCR catalysts can be prolonged by regeneration, with an impact on operation costs compared to new catalysts.

The hybrid SNCR/SCR solution can be a cost-effective solution at less than two thirds of the cost of a full SCR system.

Driving force for implementation

- Reduction of NO_x emissions.
- Possible NO_x taxes. With SCR, much higher NO_x conversions with very low NH₃ slip can be obtained compared to SNCR and primary measures. The NO_x tax of DKK 25/kg in Denmark and SEK 40/kg in Sweden are drivers for maximising the NO_x conversion of installed SCR units and thereby reduce tax.

Example plants

About 80 plants that submitted a questionnaire in 2012 for the review of this BREF are fitted with an SCR system.

See specific fuel sections for further examples.

Reference literature

[132, Rentz et al. 1999], [200, AT 2000], [202, Calepa 1999], [203, Reimer and Jensen-Holn 2013], [27, ICAC 2009]

3.2.2.3.12 Selective non-catalytic reduction (SNCR)

Description

Selective reduction of nitrogen oxides with ammonia or urea without a catalyst. The technique is based on the reduction of NO_x to nitrogen by reaction with ammonia or urea at a high temperature. The operating temperature window is maintained between 800 °C and 1 100 °C for optimal reaction.

Technical description

The temperature window strongly depends on the reagent used (ammonia, urea or caustic ammonia).

Using ammonia as a reagent, the following chemical reactions take place more or less at the same time. At the lower temperature, both reactions are too slow; at the higher temperature, the unwanted by-reaction dominates with an increase in NO_x emissions. Moreover, with load changes, the required temperature window is subjected to fluctuations in the boiler. To adjust the required temperature window with the ammonia injection, several levels of injection are necessary.

Main reaction:

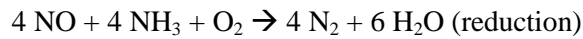

Unwanted by-reaction:

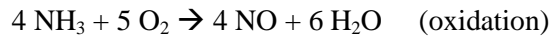

An SNCR facility consists of the following operational units:

- the reagent storage unit, for the storage, cooling, and evaporation of the reagent;
- the SNCR unit itself, where the injection of the reagent and the reaction of nitrogen oxides to nitrogen and water take place;
- an automation system for controlling the reagent injection.

The temperature window is of considerable importance as, above this, ammonia is oxidised and so even more NO_x is produced, and below this, the conversion rate is too low and ammonia can be formed. The SNCR process with different injection levels of ammonia is shown in Figure 3.47.

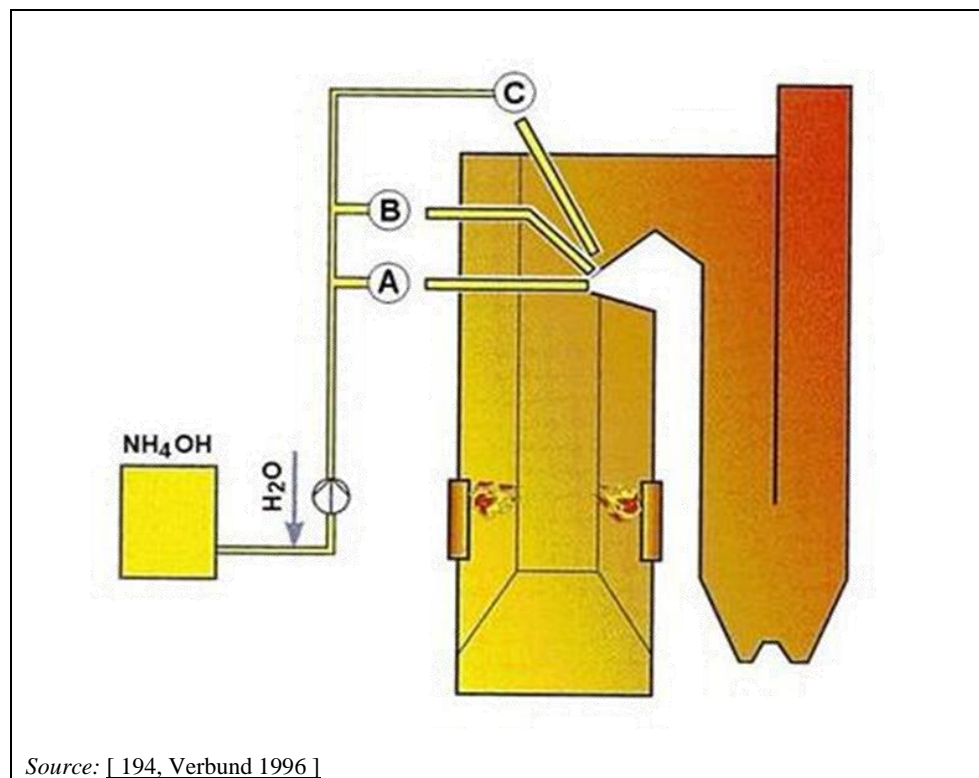

Figure 3.47: The SNCR process

In order to achieve a high abatement rate and a low NH_3 slip, the reagent and NO_x in the flue-gas must undergo sufficient mixing. Besides distribution and mixing, another relevant parameter is the size of the reagent drops. Small drops would evaporate too quickly and react at excessively high temperatures, inducing a reduced NO_x abatement rate, whereas extremely large drops would evaporate too slowly and react at excessively low temperatures, resulting in increased NH_3 slip.

Possible carriers for the reducing agent are pressurised air, steam or water. Primary measures, such as overfire air or flue-gas recirculation, can be used as a reagent carrier for the SNCR process.

Most problems with SNCR applications are related to non-uniform distribution of the reagent within the combustion chamber and injection of ammonia at incorrect locations (where oxidation rather than reduction or low reaction can occur, causing higher NO_x and higher NH_3 slip). Therefore, optimisation of the distribution system is required. Special distribution systems are used to achieve the optimal distribution of ammonia and flue-gas. CFD modelling is used for the design and then temperature control systems to precisely adjust the injection parameters.

The reaction of nitrogen oxides and ammonia/urea into water and nitrogen strongly depends on the temperature and retention time within the required temperature range, as well as on the ammonia to nitrogen oxides ratio. The temperature window for ammonia and caustic ammonia is 850 °C to 1 000 °C, with the optimum temperature being 870 °C. In comparison, the temperature window when using urea is wider (800 °C to 1 100 °C), with an optimal temperature of 1 000 °C.

The retention time within the required temperature window ranges from 0.2 to 0.5 seconds. This contact time range is rather unstable, and therefore the ammonia to nitrogen oxides ratio must be ammonia-rich rather than stoichiometric. Once more, optimisation is required as regards the molar ratio of NH_3 to NO_x . The NO_x removal rate is favoured by an increased ratio, but at the same time the ammonia slip increases too, leading to increased pollution of subsequent units (e.g. heat exchangers, flue-gas ducts). A NH_3 to NO_x ratio of between 1 and 2.5 is representative of most installations, depending on the nature of the host process and the amount of NO_x to be removed.

The equipment for the SNCR process is quite easy to install and does not take up too much space, even if, in almost every case, more than one injection level is needed. SNCR can be used alone in boilers which already have quite low emission levels. It can also be useful in boilers equipped with (a) primary reduction technique(s).

To ensure that the reagent is always injected in the upper range of the temperature window under any operating conditions, i.e. in the range where NO_x reduction is highest and NH_3 slip is lowest, acoustic gas temperature measurement systems (AGAM) are provided in plants where a high performance is required. AGAM measures the real gas temperature and determines the temperature profiles across the entire combustion chamber cross section. The temperature profile is divided into sections and can be assigned to individual lances or groups of lances to switch them to another level depending on the flue-gas temperature measured. This ensures that the reagent gets to the locations which are most effective for the reaction even at rapidly varying flue-gas temperatures. In a recent example 200 MW_e coal-fired boiler fitted with SNCR, it was decided that, due to the significant temperature differences between low load (20 %) and full load as well as the extreme temperature imbalances, five injection levels would be installed between 26 m and 51.8 m. The injectors were arranged in such a way that the right and the left sides of the boiler could be controlled independently of each other. Each injection lance could be individually activated or deactivated. [208, Von der Heide 2011]

SNCR technique for larger boilers

The SNCR technique has increasingly been developed for larger boilers in recent years as the injection technology and measurement and control of boiler cross section temperature systems have improved to allow reduction rates above 40 %, compared to the 20 % that was reported in the case of older plants. Special urea-based reagents have been developed for these boilers as aqueous ammonia would evaporate too quickly whereas urea solutions require a first evaporation step before the urea molecules become active, enabling deeper penetration. [204, CZ 2014]

Achieved environmental benefits

Reduced NO_x emissions to air.

Environmental performance and operational data

Table 3.27: Performance of the SNCR technique for reducing nitrogen oxide emissions

General NO _x reduction rate	Other performance parameters	
	Parameter	Value
30–50 %	Operating temperature	800–1050 °C
	Reducing agent	Ammonia, urea
	NH ₃ to NO _x ratio	1.5–2.5
	Availability	> 97 %
	NH ₃ slip	< 10 mg/Nm ³
	Energy consumption as % of electric capacity	0.1–0.3 %
	Residence time within temperature range	0.2–0.5 s
NB: Though some manufacturers report a NO _x reduction level of over 80 %, the common view is that SNCR processes are, in general, capable of 30–50 % reduction as an average covering different operational conditions and different initial levels of NO _x concentrations. Further NO _x reductions can be obtained in specific boilers where the conditions are good, as well as lower values where the conditions are bad, sometimes in existing plants. <i>Source: [148, CIEMAT 2000]</i>		

Cross-media effects

The choice of reagent influences the formation of nitrous oxide (N₂O). The use of ammonia or caustic ammonia induces negligible amounts of N₂O, whereas relatively high amounts can be measured when injecting urea directly into the boilers. To overcome this problem and to almost eliminate N₂O formation entirely, urea can be injected into the burnout air. Moreover, the use of urea as a reagent for SNCR leads to higher corrosion problems than when using ammonia or caustic ammonia. Therefore, materials should be chosen carefully.

Other cross-media effects are linked to the use of ammonia, through:

- the release of NH₃ to air, in the case of inhomogeneous reactions between NO_x and NH₃ in a plant not fitted with a downstream wet FGD system;
- the formation of ammonium sulphates when combusting sulphur-containing fuels such as liquid refinery fuel;
- safety issues related to the ammonia storage.

(See further details in Section 3.2.2.3.13.)

Technical considerations relevant to applicability

The applicability for retrofitting an existing unit may be constrained by the temperature window and residence time required to inject the reactant. Ammonia slip is also a limiting factor. In some cases, operating and physical constraints can make retrofitting difficult, e.g. the required temperature window may occur in the middle of the boiler tube bank and could lead to impingement of the injected chemical against the tubes.

The applicability or environmental performance may be limited in the case of boilers with load variations or with variable fuel quality. The use of several levels of reagent injection and/or the use of a slip catalyst (SCR) may be a possibility to address this problem.

The applicability may be limited in the case of big boilers with high cross-sectional areas.

SNCR cannot be used on gas turbines or engines because of the residence time and temperature window required. [205, Schüttenhelm et al. 2013]

Economics

The actual construction costs depend on the boiler and its operating profile. According to an estimate from a European SNCR provider, the levelised costs are approximately EUR 430 per tonne of NO_x reduced in a coal-fired 250 MW_{th} boiler operating for 4 000 h/yr, assuming a baseline NO_x level of 400 mg/Nm³ and a NO_x reduction of 50 %. Also taking into consideration the reagent costs, loss of efficiency for the host plant and maintenance costs, the same European SNCR and reagent supplier estimated a levelised cost for the 50 % NO_x reduction to be approximately EUR 1 400 per tonne of NO_x reduced if using 24.5 % aqueous ammonia as a reagent. If using 40 % urea solution, the estimated costs of NO_x removal is approximately EUR 1 500 per tonne of NO_x reduced. A project life of 10 years has been assumed in the calculations and a NH₃ to NO_x ratio of 1.2 (20 % higher for urea solution). [120, EEB 2013] [206, Yara 2012]

Driving force for implementation

- Reduction of NO_x emissions.
- Lower capex than SCR.
- No need for additional space, e.g. for structures, reactor and ductwork.
- No catalyst pressure drop and no associated need to modify existing equipment (duct, ESP, fans).

Example plants

Electrownia 'Rybnik' SA – 225 MW_e coal-fired boiler.

About 30 plants that submitted a questionnaire in 2012 for the review of this BREF are fitted with an SNCR system.

See specific fuel sections for further examples.

Reference literature

[205, Schüttenhelm et al. 2013] [207, FuelTech 2008] [208, Von der Heide 2011]

3.2.2.3.13 Ammonia-related issues when using SCR/SNCR techniques

One possible disadvantage of the SCR/SNCR techniques is related to the ammonia slip, which is the emission of unreacted ammonia into the environment.

This occurs in the case of incomplete reaction of NH₃ with NO_x, when small amounts of NH₃ leave the reactor / combustion chamber with the flue-gas, and may be due to catastrophic failure of the whole SCR system or to an increase of the NH₃ to NO_x ratio when looking to increase the SCR/SNCR system efficiency. This effect is known as ammonia slip (NH₃ slip). High ammonia slip (NH₃ breakthrough) can lead to the following:

- The formation of ammonium sulphates, which form deposits on downstream systems such as the catalyst and air preheater and on surfaces below 235 °C, or can result in increased dust emissions. Deposits can be minimised by keeping the ammonia slip low and monitoring the downstream flue-gas temperature. Deposits can be cleaned on-line by water washing or by raising metal temperatures above the condensation temperature to sublime deposits with suitably designed materials.
- NH₃ in flue-gas desulphurisation waste waters and air heater cleaning water.
- And an increased NH₃ concentration in the fly ash, which may affect its disposal or sale.

When SCR is implemented, the ammonia slip increases with an increasing NH_3 to NO_x ratio and with a decreasing catalyst activity.

When SNCR is implemented, the ammonia slip increases with poor NH_3 and flue-gas mixing conditions, due to lack of residence time within the reaction temperature window, and with an increasing NH_3 to NO_x ratio.

When a downstream wet flue-gas desulphurisation (WFGD) system is implemented, the NH_3 slip is further dissolved in water.

In order to avoid problems with the utilisation of fly ash and possibly the smell of the flue-gas in surrounding areas, the ammonia concentration associated with the use of SCR or SNCR is usually kept below 10 mg/Nm^3 . When fuels with very low-ash content are used, ammonia slip can also lead to ash that is too high in ammonia to handle safely.

Limiting the ammonia slip for SCR systems can be solved by using a larger catalyst volume and/or by improving the mixing of NH_3 and NO_x in the flue-gas.

The ammonia slip is often the limiting factor in the utilisation of the SNCR technique. To avoid ammonia slip with the SNCR technique, a low layer of SCR catalyst can be installed in the economiser area of the boiler. As this catalyst reduces the ammonia slip, it also reduces the corresponding amount of NO_x .

Both SCR and SNCR techniques use ammonia or urea as a reducing agent. Urea is more commonly used in combustion plants below $50 \text{ MW}_{\text{th}}$ than in large SCR or SNCR applications.

Health and safety risks related to the use of pure liquefied ammonia exist, e.g. for the handling and storage of pure liquefied ammonia, pressure reservoirs may need to be double-walled and located underground. No impact on health arises from solid urea storage. From a safety point of view, the use of an ammonia-water solution is less risky than the storage and handling of pure liquefied ammonia.

The most common form of ammonia used for SCR and SNCR is aqueous ammonia, normally available in a 24.5 % concentration or lower. Aqueous ammonia is a non-flammable liquid, and is classified as an irritant. Aqueous ammonia can be stored under atmospheric conditions. Pure anhydrous ammonia is classified as a flammable, toxic and corrosive gas, and is combustible in air concentrations between 15 % and 28 % and has to be stored under pressure (vapour pressure of 7.6 bar at 20°C).

Because of the high risk of ammonia to human health, ammonia transportation, handling and storage need to be carried out very carefully to avoid any leakage. Monitoring systems are installed for the detection of low ammonia concentrations around the ammonia storage and handling area. Pressurised and hydrous ammonia are regulated under the Seveso III Directive (2012/18/EU) and corresponding national regulations.

The stress corrosion risk for steel vessels requires regular monitoring of tank integrity and quality control for traces of hydrogen or oxygen in the supplied liquid ammonia.

3.2.2.4 Combined techniques to prevent and/or reduce SO_x, NO_x and other pollutant emissions

3.2.2.4.1 Activated carbon process

Description

This process is based on the adsorption of pollutant molecules by the activated carbon. When the surface has adsorbed as much as it can, the adsorbed content is desorbed as part of the regeneration of the adsorbent.

Technical description

As activated carbon has a very large specific surface area, it has been used widely as an air cleaning and waste water treatment agent since the nineteenth century. It has also been known for a long time that activated carbon adsorbs SO₂, oxygen and water to produce sulphuric acid. Simultaneous SO₂ and NO_x removal becomes possible by adding ammonia.

The flue-gas from the combustion plant is first dedusted, passed through a heat exchanger where heat is extracted for activated carbon regeneration, and then cooled in a water pre-scrubber. The gas enters the first stage of the activated carbon (dry porous charcoal) bed at a temperature of 90–150 °C. The sulphur dioxide reacts with oxygen and water vapour in the flue-gases (through catalytic oxidation) to form sulphuric acid, which is adsorbed on the activated carbon.

Prior to entering the second-stage adsorber, ammonia is injected into the flue-gases in a mixing chamber. Nitrogen oxides react catalytically with the ammonia in the second stage to form nitrogen gas (N₂) and water. The cleaned flue-gases and liberated nitrogen and moisture pass to the stack for discharge. The reduction process takes place in an adsorber, where the activated carbon pellets are transported from the top to the bottom by a moving bed. The gas flows across the layers, first entering the lowest part of the bed.

The sulphur-laden activated carbon passes to a regenerator where desorption is performed thermally, by indirect heating, using heat extracted earlier from the flue-gases at a temperature of about 400–450 °C. Carbon dust is removed and make-up pellets added prior to recycling them back to the adsorber. As a result of the regeneration, enriched SO₂ gas is generated from the desorber. The enriched gas is converted, using a Claus or another process, to elemental sulphur, or sulphuric acid that can be sold as a by-product. Figure 3.48 shows a schematic diagram of the activated carbon process.

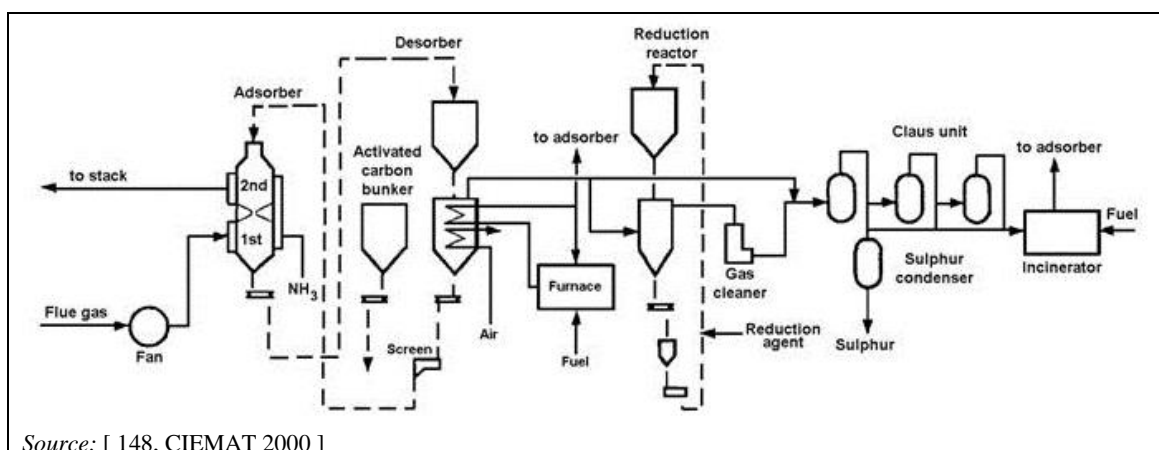

Source: [148, CIEMAT 2000]

Figure 3.48: The activated carbon process

Achieved environmental benefits

The process is capable of cleaning flue-gases from different fuel types such as coal and oil.

The activated carbon process also has considerable potential for removing SO₃ and air-toxic substances such as mercury and dioxins.

Environmental performance and operational data

Table 3.28: Performance of the activated carbon technique for reducing sulphur oxide/nitrogen oxide/mercury emissions

Technique	General SO ₂ /NO _x reduction rate	General Hg reduction rate	Other performance parameters	
			Parameter	Value
Activated carbon process	98 % / 60–80	> 90 %	Operating temperature	90–150 °C
			Reagent	Activated carbon/ammonia
			Reliability	98 %
			Other substances removed	HCl, HF, dioxins
			Energy consumption as % of electric capacity	1.2–3.3 %
			By-products	Elemental sulphur or sulphuric acid

Activated carbon techniques combined use only a fraction of the water used in conventional abatement systems, e.g. at a Japanese plant, water use is as low as 1 % of the water used in wet FGD.

Cross-media effects

Waste water is only produced in small amounts from the operation of the pre-scrubber.

Technical considerations relevant to applicability

No information provided.

Economics

No information provided.

Driving force for implementation

No information provided.

Example plants

Several commercial systems have been installed, mainly in Japan, e.g. J-Power Isogo Units 1 and 2 (2009) with: dust emission levels of < 10 mg/Nm³ for Unit 1 and < 5 mg/Nm³ for Unit 2; NO_x emission levels of < 40 mg/Nm³ for Unit 1 and < 26 mg/Nm³ for Unit 2; and SO_x emission levels of < 56 mg/Nm³ for Unit 1 and < 28 mg/Nm³ for Unit 2.

Reference literature

[290, Higa et al. 2012] [291, Peters 2010] [292, Gilbert et al. 2008]

3.2.2.4.2 WSA-SNO_x process

Description

WSA-SNO_x process (Wet gas sulphuric acid with integrated selective catalytic reduction DeNO_x step) employs two catalysts sequentially to remove NO_x by SCR and to oxidise SO₂ to SO₃, condensing the latter as sulphuric acid for sale.

Technical description

About 98 % and 95 % of the sulphur and nitrogen oxides respectively in the flue-gas can be removed. The process produces no waste water or waste products, nor does it consume any chemical apart from ammonia for NO_x control.

Figure 3.49 shows a flow diagram of the WSA-SNO_x process installed in a 300 MW_e coal-fired power plant in Denmark.

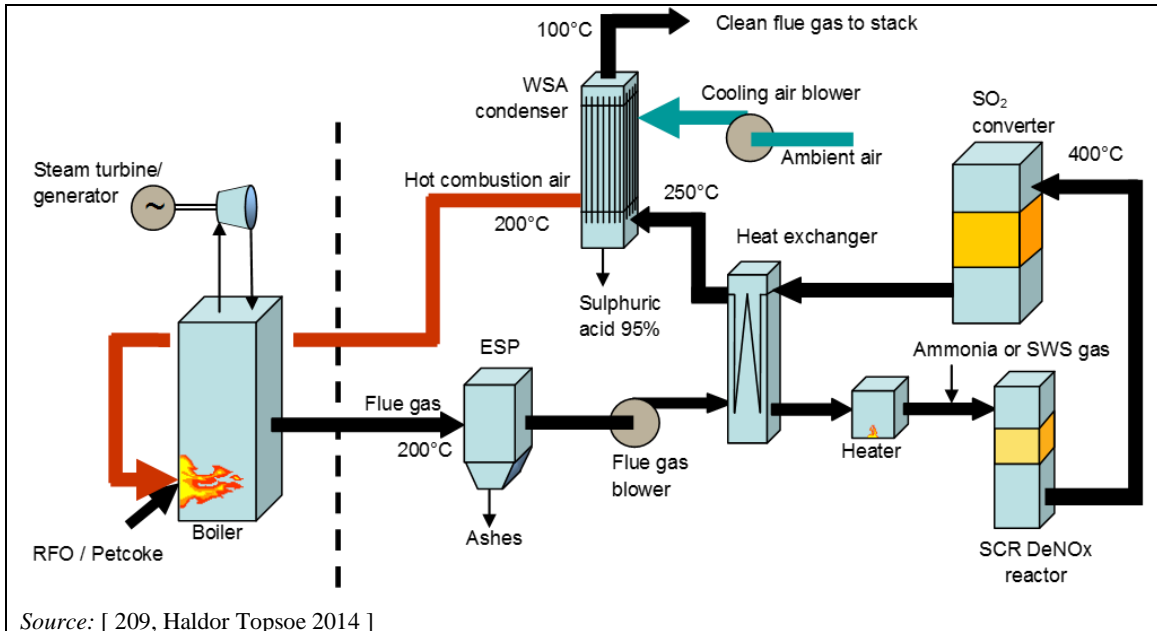

Figure 3.49: The WSA-SNO_x process

Here, flue-gas leaving the air preheater is treated in a particulate control device and passes through the cold side of a gas-gas heat exchanger, which raises the flue-gas temperature to above 370 °C. An ammonia and air mixture is then added to the flue-gas prior to the SCR, where nitrogen oxides are reduced to N_2 and water.

As the flue-gas leaves the SCR, its temperature is adjusted slightly, and it then enters the SO_2 converter, which oxidises SO_2 to sulphur trioxide (SO_3). The SO_3 -laden gas passes through the hot side of the gas-gas heat exchanger, where it is cooled as the incoming flue-gas is heated. The processed flue-gas then enters a falling film condenser (the WSA condenser), where it condenses out of the gas phase on to borosilicate glass tubes and is subsequently collected, cooled, and stored. The acid product concentration is typically 93–95 % and of commercial quality, suitable for use in fertiliser production for example. The flue-gas, now free of SO_3 , is passed to the stack at a temperature of around 100 °C, while the hot, used cooling air can be used in the boiler as preheated combustion air.

In this process, it is possible to recover thermal energy from the SO_2 conversion, SO_3 hydrolysis, sulphuric acid condensation and the DeNO_x reaction. The recovered energy is used for increased steam production. Hence, the absolute decrease in net efficiency is as low as 0.2 % at a 300 MW_e plant (with 1.6 % sulphur coal). Typically each per cent of sulphur in the coal results in 1 % additional steam production. When the coal contains 2–3 % sulphur, the steam production is considered to compensate for the power consumption of the WSA-SNO_x process, and a boiler using fuel with 5 % sulphur and fitted with the WSA-SNO_x process is able to export around 5 % more steam than a boiler with limestone-based FGD, or alternatively use 5 % less fuel for the same steam production.

Achieved environmental benefits

- Dust, SO_x and NO_x emissions reduction.
- Very low particulate emissions (below 5 mg/Nm³).
- Increase in energy efficiency.
- Organic compounds, e.g. PAHs, dioxins and furans, are degraded by catalytic oxidation in the SO₂ oxidation catalyst.

Environmental performance and operational data**Table 3.29: Performance of the WSA-SNO_x technique for reducing sulphur oxide/nitrogen oxides emissions**

Technique	General SO ₂ /NO _x reduction rate	Other performance parameters	
		Parameter	Value
WSA-SNO _x process	98 % / 95 %	Reagent	Ammonia
		Energy consumption as % of electric capacity	0.2 %

Cross-media effects

No information provided.

Technical considerations relevant to applicability

The technique can be applied in any type of boiler to reduce the emission of sulphur, NO_x and dust, but high-sulphur fuel is essential. If the fuel applied in the boiler contains less than a certain minimum amount of sulphur (e.g. 0.5 %), the sulphuric acid produced will contain more water and perhaps become difficult to transport because of its corrosiveness.

The technique requires approximately the same space as other FGD systems.

Economics

Table 3.30 and Table 3.31 give information about the main features and associated operating costs of the WSA-SNO_x technique implemented at an example plant.

Table 3.30: Main features of the plant taken as an example for the operating costs of the WSA-SNO_x technique in Table 3.31

Parameter	Unit	Value
Net electrical output	MW _e	300
Net electrical efficiency (LHV)	%	39
Fuel consumption (pet coke)	t/h	88.3
SO _x removal efficiency	%	98
NO _x emissions to air	mg/Nm ³	< 40
H ₂ SO ₄ production	t/h	15.6
NH ₃ consumption	t/h	0.25
Other reagent consumption	t/h	0
Waste generation	t/h	0
Water consumption	m ³ /h	0

Source: [209, Haldor&Topsoe 2014]

Table 3.31: Operating costs of the WSA-SNO_x technique at the example plant described in Table 3.30 operated 8 000 h/yr

Parameter	Unit	Value
H ₂ SO ₄ sold at USD 15/t	USD/yr	-1 800 000
NH ₃ supplied at USD 300/t	USD/yr	600 000
Other reagent supplied	USD/yr	0
Water consumption USD 1/m ³	USD/yr	0
Waste water disposal cost USD 1/m ³	USD/yr	0
Waste disposal cost USD 20/t	USD/yr	0
Total	USD/yr	-1 200 000
Cost impact per MWh	USD	-0.50
<i>Source: [209, Haldor&Topsoe 2014]</i>		

Driving force for implementation

- No limestone or gypsum or the associated infrastructure.
- Energy efficiency (recycling of hot, preheated air to the boiler) and reduced CO₂ emissions.
- No water consumption.

Example plants

See Figure 3.49, example of a 300 MW_e coal-fired plant located in Denmark (Nordjyllandsværket – since 1991).

Agip in Gela (IT) (Pulverised pet coke boilers with 6 % sulphur – since 1999).

OMV refinery, Schwechat (AT) (Plant burning heavy visbreaker – since 2007).

Reference literature

[209, Haldor&Topsoe 2014]

3.2.2.4.3 DeSONO_x process**Description**

In the DeSONO_x process, flue-gases are first passed through an ESP to remove dust, followed by ammonia injection and SCR. The gases are then cooled by preheating combustion air, and the fully treated flue-gases are then reheated prior to release to the atmosphere.

Technical description

The temperature of the flue-gas is reduced to approximately 140 °C, which enables the catalytic oxidation of SO₂ to SO₃ and its subsequent condensation as sulphuric acid (70 %). The latter step is accomplished in a recirculating acid tower. The flue-gases are finally directed through a wet electrostatic mist precipitator and are reheated prior to release (see Figure 3.49).

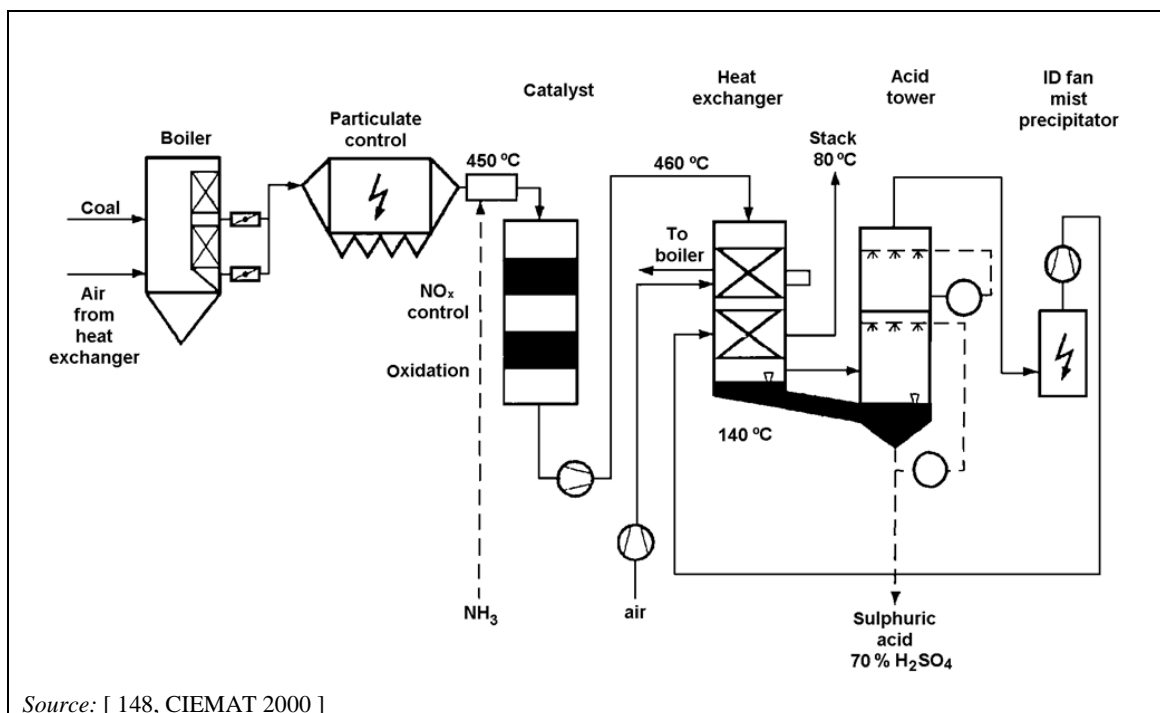

Figure 3.50 The DeSONO_x process

In theory, it is possible to produce liquid SO₂, sulphuric acid and elemental sulphur but plants commissioned to date have only produced sulphuric acid.

Achieved environmental benefits

Dust, NO_x and SO_x emissions reduction.

Environmental performance and operational data

Table 3.32: Performance of the DeSONO_x technique for reducing sulphur oxide/nitrogen oxides emissions

Technique	General SO ₂ /NO _x reduction rate	Other performance parameters	
		Parameter	Value
DeSONO _x process	95 % / 95 %	Reagent	Ammonia
		Reliability	96–98 %
		Energy consumption as % of electric capacity	2.0 %

Cross-media effects

Waste water is generated by the use of a wet ESP for the removal of sulphuric acid aerosols.

Technical considerations relevant to applicability

No information provided.

Economics

No information provided.

Driving force for implementation

No information provided.

Example plants

No information provided.

Reference literature

No information provided.

3.2.2.5 Techniques to prevent and/or reduce metal emissions

Most metals have sufficiently low vapour pressures at typical air pollution control device operating temperatures that condensation onto particulate matter is possible. However, mercury has a high vapour pressure at typical control device operating temperatures, and collection by particulate matter control devices is highly variable. The most important factors affecting mercury control for utility boilers include the flue-gas volume, flue-gas temperature and chloride content, the mercury concentration and the chemical form of the mercury being emitted. The partitioning of mercury into its three forms (Hg^0 , Hg^{2+} , and Hg_p) is referred to as mercury speciation, and the degree to which speciation occurs can substantially affect mercury control approaches. Mercuric chloride (HgCl_2 or Hg^{2+}) compounds are soluble and can be captured in FGD systems used for SO_2 removal. Hg_p compounds or Hg compounds adsorbed onto the surface of other particles can be captured to varying degrees using particulate matter control devices, such as bag filters or ESPs. This process may be facilitated by the use of additives, such as activated carbon. Primary measures (fuel cleaning, blending and additive addition) may allow reductions of mercury emissions to air of up to 80 %, depending on the fuel characteristics and the techniques used. For more information, see Section 5.1.3.4.3.1 on coal and lignite pretreatment.

In general, high levels of carbon in the fly ash enhance mercury sorption onto particulate matter, which is subsequently removed by the particulate matter control device. Additionally, the presence of hydrogen chloride (HCl) in the flue-gas stream can result in the formation of mercuric chloride, which is removed in the FGD system. Conversely, sulphur dioxide (SO_2) in flue-gas can act as a reducing agent to convert oxidised mercury to elemental mercury, which is more difficult to collect.

Control technologies designed for controlling pollutants other than mercury (e.g. acid gases and particulate matter) vary in their mercury removal capability, depending on fuel characteristics and on the control technology configuration (see the example for coal-fired plants in Section 5.1.3.4.2). [27, ICAC 2009]

3.2.2.5.1 Reduction of metal emissions in dust abatement systems

Description

The co-benefit capture, in dust abatement systems, of metals that have reacted with or formed particulates.

Technical description

The particulate concentration in flue-gas is mainly affected by the ash content in the coal burnt. Particles tend to be the adsorbents in flue-gas.

Electrostatic precipitators and bag filters are commonly used to remove dust from flue-gases generated by combustion plants burning solid or liquid fuels. These systems can operate with an overall particulate removal efficiency of > 99.9 %. However, the removal efficiency is generally lower in the smaller particle size range, i.e. the size range in which particles enriched with metal elements might be found.

ESPs are the most commonly used dedusting technique in coal-fired power plants. Particulate-bound mercury and other metals are removed when the particles are captured by the ESP.

ESPs can capture nearly all Hg_p . When the flue-gas flows through the charging electrode, all particles are loaded with a negative charge. When the particles with a negative charge pass through the collecting boards which have a positive charge, they are collected on the dust-collecting electrode. Although gas-phase mercury is barely removed by ESPs, it does transform continuously across the ducts and devices. Oxidised mercury, on the other hand, will move forward along with the flue-gas. Therefore, Hg^{2+} is unlikely to be adsorbed onto particles to transform to Hg_p . However, some of the Hg^0 will be adsorbed or oxidised into Hg_p or Hg^{2+} when cooling to 400 °C, which explains the fact that the total gaseous mercury may decrease when going through the ESP. [28, S.Wang et al. 2009]

Bag filters (BF) have a similar overall particulate removal efficiency to ESPs (i.e. greater than 99.9 %) but are better at abating fine particulate matter and less sensitive to particulate loading and fly ash characteristics. The collection efficiency may be increased further still by using flue-gas conditioning with small amounts of additives added to the gas flow upstream of the filters.

Regarding mercury, some elements may remain in the gas phase until the flue-gases have cooled sufficiently for condensation to occur. By the time the flue-gases reach the BF, they have cooled sufficiently to also allow some condensation of Hg, similar to a cold-side ESP. A BF can be more effective than an ESP, especially with bituminous coals, because of the increased contact with the flue-gas containing fly ash and unburnt carbon as they accumulate as a filter cake on the BF. This filter cake contributes to greater heterogeneous oxidation and the adsorption of mercury. For hot-side ESPs, this difference is accentuated because the capture of mercury on fly ash is less effective at higher temperatures [2, EEB 2012]

The Hg removal efficiency in an ESP depends on the following factors:

- temperature of the ESP;
- halide content in the fuel;
- unburnt carbon-in-ash;
- calcium compounds in the ash.

Achieved environmental benefits

Reduced metal and dust emissions.

Environmental performance and operational data

An average Hg removal efficiency of about 40 %, up to more than 90 %, can be achieved in combustion plants fitted with a BF.

According to mercury emission tests performed at six plants in China, the average removal efficiency of ESP systems was 11 %, and varied from 6 % to 52 %; that of the BF systems was 52 %, much lower than the average removal efficiencies of pollution abatement devices in US plants. The removal efficiency of ESPs combined with WFGD was around 70 % for bituminous-coal-fired plants. This removal efficiency may also depend on the presence upstream of an SCR system. [28, S.Wang et al. 2009]

A statistical survey, based on more than 25 years of mercury measurements at Dutch coal-fired power plants, shows overall removal of Hg by flue-gas cleaning devices ranging from 50 % to over 90 %. On average, roughly 50–70 % of the mercury is removed at the ESP and half of the remaining 30–50 % is removed at the wet FGD. [73, KEMA - VGB Powertech 2012]

Example reduction efficiencies for other metals in the case of pulverised coal plants fitted with dust control techniques are given in Table 3.33.

Table 3.33: Metal reduction efficiencies (%) achieved in a conventional pulverised-coal-fired plant

Trace element	Conventional pollution abatement	
	ESP	Bag filter
Sb	96	97
As	98.5	98.5
Ba	99.5	98
Be	98.5	98.5
B	68	97
Cd	83	94
Cr	97.5	99.5
Co	98	99
Cu	89	99.5
Pb	98	98.5
Mn	97	99.5
Hg	30	60
Mo	96	100
Ni	96	99
Se	21	65
V	98	100
<i>Source: [67, Nalbandian 2012]</i>		

Cross-media effects

No information provided.

Technical considerations relevant to applicability

No information provided.

Economics

See Sections 3.2.2.1.1 and 3.2.2.1.2.

Driving force for implementation

No information provided.

Example plants

See Sections 3.2.2.1.1 and 3.2.2.1.2.

Reference literature

No information provided.

3.2.2.5.2 Reduction of metal emissions in FGD systems**Description**

Capture of metals in soluble or oxidised form using a desulphurisation system, as a co-benefit of FGD.

Technical description

Wet scrubber FGD systems are an effective method for reducing emissions of certain metals. This is mostly because the flue-gas temperature is reduced to about 50–60 °C by passing through the absorber, which allows many of the more volatile metals to condense from the vapour phase, and allows them to be removed from the flue-gas. The condensed metals are then mainly transferred to the waste water from the wet FGD system.

Spray dry absorbers configured with a particulate removal system before a spray dry scrubber have high metal retention, so a large proportion of these elements (including volatile species) are removed before the FGD unit. The highest particulate removal efficiencies, especially for

fine particles, are achieved by spray dry systems fitted with downstream bag filters. These systems may also be expected to achieve the highest metal removal efficiencies.

Duct sorbent injection (DSI) with pre-humidification and a CFB scrubber have a similar capability to reduce heavy metals, including mercury, as spray dry absorbers. The vaporisation of water reduces the flue-gas temperature and this, in combination with a high-efficiency particulate removal device, such as a bag filter, efficiently removes mercury and other metals. The mercury removal is further enhanced if activated carbon is injected before the modified dry scrubber.

Achieved environmental benefits

Reduced metal and SO_x emissions.

Environmental performance and operational data

Various studies have given removal efficiencies from the flue-gas of 30–50 % for Hg and 60–75 % for Se. However, the lime used in some systems may be an important source of As, Cd, Pb and Zn, and so the concentrations of these elements can even increase downstream of the FGD. Emissions from the scrubber depend on the specific process, operating conditions and specific control technology configuration.

An average Hg removal efficiency of 96.6 % was achieved for instance by adding sodium hypochlorite additives to the flue-gas from a waste incinerator in Japan. Sodium hypochlorite stabilises the Hg in the flue-gas, allowing it to be captured in the scrubber water. The Hg can then be removed from the waste water stream using reduction, volatilisation, condensation and Hg separation processes. In another example related to six Chinese coal-fired plants, 67–98 % of the Hg²⁺ was absorbed in the scrubber solution and retained in the FGD gypsum. A higher concentration of Hg²⁺ in the flue-gas led to a higher removal efficiency in the wet FGD. The reduction of Hg⁰ in the flue-gas in a wet FGD was less than 30 %. The removal efficiency of an ESP in combination with WFGD is around 70 % for bituminous-coal-fired plants. [28, S.Wang et al. 2009]

The overall removal of Hg in various spray dry systems varies from about 35 % to 85 %. Plants fitted with dust removal systems before the spray dry scrubber have Hg removal efficiencies up to 70 %, even before entering the FGD unit.

Example reduction efficiencies for other metals in the case of a pulverised coal plant fitted with FGD are given in Table 3.34.

Table 3.34: Metal reduction efficiencies (%) achieved in a conventional pulverised-coal-fired plant

Trace element	Flue-gas desulphurisation (venturi scrubber)
Sb	99
As	98.5
Ba	99.5
Be	98.5
B	63
Cd	96
Cr	99.5
Co	99
Cu	99
Pb	99
Mn	99.5
Hg	20
Mo	99
Ni	99
Se	60
V	99.5
<i>Source: [67, Nalbandian 2012]</i>	

Cross-media effects

There may be accumulation of metal concentrations in FGD gypsum which need to be avoided not to jeopardize the use of FGD gypsum.

Under some conditions, oxidised mercury may be reduced to elemental mercury in wet FGD units, and this could be re-emitted. When gaseous compounds of oxidised mercury (Hg^{2+}) are absorbed in the liquid slurry of a wet FGD system, the dissolved species are believed to react with dissolved sulphides from the flue-gas to form mercuric sulphide (HgS), which precipitates from the liquid solution as sludge.

In the absence of a sufficient concentration of sulphides in the liquid solution, a competing reaction with sulphites that reduces dissolved Hg^{2+} to elemental mercury (Hg^0) is believed to take place. Once this reduction occurs, the newly formed Hg^0 is transferred to the flue-gas and increases the concentration of Hg^0 in the flue-gas passing through the wet FGD. Hg^{2+} reduction and subsequent Hg^0 re-emission may be more significant in magnesium-enhanced limestone scrubbers, which operate with a much higher sulphite concentration than limestone systems.

The wet FGD redox potential also plays an important role in the possible reduction of Hg^{2+} to Hg^0 and the consequent re-emission of Hg.

In some cases, the reduction of Hg^{2+} to Hg^0 and subsequent re-emission are abated with the help of sulphide-donating liquid reagent. In addition, transition metals in the slurry (originating from fly ash in the flue-gas) are believed to play an active role in the conversion reaction, since they can act as catalysts and/or reactants for reducing oxidised species. There also appears to be increased potential for re-emission of mercury in wet FGD systems with appreciable concentrations in the liquor phase.

Technical considerations relevant to applicability

No information provided.

Economics

No information provided.

Driving force for implementation

No information provided.

Example plants

No information provided.

Reference literature

No information provided.

3.2.2.5.3 Reduction of metal emissions in NO_x control systems**Description**

Conversion of mercury from an elemental form to a more easily capturable oxidised form, through selective catalytic reduction.

Technical description

SCR systems can be enhanced by the addition of catalysts to specifically convert elemental mercury to oxidised mercury, which can be subsequently captured by a wet FGD scrubber. For low-halide fuels, the high-dust catalysts may require augmentation of the flue-gas chlorine or bromine to be effective, whereas tail-end catalysts are effective without chlorine augmentation. Beyond mercury, there is no evidence that NO_x control systems have any significant influence on trace element behaviour or removal.

Parameters affecting the degree of oxidation of elemental mercury include the halide content (e.g. HF, HCl), flue-gas temperature, catalyst chemistry, catalyst age, and flue-gas constituents from the combustion and concentration/distribution of NH₃ in the flue-gas (increasing the NH₃ concentration reduces the Hg oxidation). [29, Pritchard et al. 2010], [2, EEB 2012]

Achieved environmental benefits

- Reduced Hg emissions when combined with an FGD system.
- Reduced NO_x emissions.

Environmental performance and operational data

Advanced catalysts used in selective catalytic reduction (SCR) can oxidise up to 95 % of the vapour-phase mercury from an elemental form to a soluble ionic form, which can be readily captured in a downstream wet FGD system. For bituminous-coal-firing boilers, an overall mercury capture of 80 % to over 95 % has been observed in full-scale plant tests, where SCR followed by wet FGD was used. Plant 123 has been undertaking long-term trials with such a catalyst and the injection of precipitation additive into the scrubber to reduce mercury emissions. Reported air emissions data show that 100 % of daily values in 2011 and 2012 were < 5 µg/Nm³, and more than 90 % (2011) and 98 % (2012) of daily values were < 3 µg/Nm³.

In a Chinese study related to mercury emissions and speciation in coal-fired power plants in China, it was concluded that a conventional SCR system oxidised 13 % of the elemental mercury, and that ammonia injection before SCR might have a positive effect on the adsorption of mercury onto particulate matter. [28, S.Wang et al. 2009]

Cross-media effects

See Section 3.2.2.3.11.

Technical considerations relevant to applicability

See Section 3.2.2.3.11.

Economics

See Section 3.2.2.3.11.

Driving force for implementation

See Section 3.2.2.3.11.

Example plants

See Section 3.2.2.3.11.

Reference literature

See Section 3.2.2.3.11.

3.2.2.5.4 Reduction of metal emissions by specifically designed systems

Description

Use of dedicated additive/sorbent, generally in addition to existing abatement equipment.

Technical description

Some systems have been developed expressly for the purpose of reducing certain metals from flue-gas streams, mostly to reduce emissions of Hg and other toxic metals (such as As, Cd and Pb) from waste incinerators. These systems include selenium filters, activated carbon filters and various sorbents. They are only briefly discussed in this section.

Different sorbents such as silica, bauxite (alumina), kaolinite, emathlite and lime have been investigated for their ability to remove metals from flue-gas. A detailed list of these and other possible sorbents can be found in [148, CIEMAT 2000] but some of the processes are of limited practical use for large power stations because of the low operating temperatures, harmful secondary effects and the high cost of some of the sorbents.

A long-term mercury control research and development programme was undertaken by the US Department of Energy, which concluded, in 2008, that systems injecting sorbents into the flue-gas from coal-fired power plants are ready for commercial deployment (see further details in Section 5.1.3.4.3). [2, EEB 2012]

Activated carbon or coke filter systems have been developed which can be used to remove metals such as Cd, Hg and Pb from flue-gases. Information can be found in [148, CIEMAT 2000] regarding a lignite coke filter and catalyst system which, in addition to acid gas removal, adsorbs metal elements. Tests carried out in a pilot-scale system, fitted to a municipal waste incinerator, indicate that virtually all the Hg is removed from the flue-gases by the lignite coke material. Activated carbon technology has also been applied in the US to increase Hg removal in spray dry scrubber/ESP systems. See further details on carbon sorbent injection for mercury reduction in Section 5.1.3.4.3.2.

The removal of Hg vapour from flue-gases using sulphur-impregnated adsorbents has been studied using packed beds. The experimental results have shown that the impregnation of active alumina and zeolite by sulphur increases the adsorption capacity by several orders of magnitude. Although the sorbents have a high Hg adsorption capacity, they are unable to remove all the Hg (as they already have an outlet concentration greater than zero for gases passing through the filters, even at the start of gas breakthrough).

A system is available for Hg removal that uses a selenium-impregnated filter which may be retrofitted to existing exhaust ducting after scrubbers. The filter relies on the strong affinity of Hg to Se, with which it combines to form mercury selenide (HgSe), a highly stable compound. Spent filters are returned to the manufacturer for recharging.

It is also possible to reduce Hg emissions using additives in other FGD systems, such as dry injection systems. With regards to the additive, Sorbalit may be added for instance. This is a sorbent that is composed of calcium hydroxide and various other organic and inorganic constituents.

Achieved environmental benefits

Reduced specific metals emission.

Environmental performance and operational data

Environmental performances achieved when using activated carbon injection or halogenated additives addition are given in Section 5.1.3.4.3.

Very low Hg concentrations in the flue-gases may be achieved using a bed of sulphur-impregnated active alumina and zeolite adsorbents, followed by a second bed of sulphur-impregnated activated carbon adsorbents.

Cross-media effects

See Section 5.1.3.4.3.

Technical considerations relevant to applicability

See Section 5.1.3.4.3.

Economics

See Section 5.1.3.4.3.

Driving force for implementation

See Section 5.1.3.4.3.

Example plants

See Section 5.1.3.4.3.

Reference literature

See Section 5.1.3.4.3.

3.2.2.5.5 Reduction of metal emissions by use of a metal separator in the fuel supply line

Description

Removal of ferromagnetic matter contained in the fuel/waste before combustion.

Technical description

Before entering the boiler, ferromagnetic foreign matter is precipitated out of the fuel mixture by means of a magnetic iron separator. In the metal separator, magnet technology is used to remove magnetic metals before contaminants (large/heavy parts) are removed in the classifier and then passed to a mill for recycling.

Achieved environmental benefits

Reduced specific metals emission.

Environmental performance and operational data

The reduction in the metal input reduces the danger of malfunctions occurring in the downstream plant sections and limits their associated environmental impacts.

Cross-media effects

Limited electrical consumption.

Technical considerations relevant to applicability

Plant-specific.

Economics

- Limited capex and opex.
- Metallic waste recovered can be sold for reuse.
- Reduction in O&M expenditures due to reduced malfunctions in downstream processes.

In general, the metal separator is included in a dedicated feeding line for waste. In the case of Plant 142, such a line represented an investment of about EUR 14.5 million (2003 price level) and has a yearly O&M cost of about EUR 2.5 million (fixed costs, 2010 price level).

Driving force for implementation

Non-environmental triggers (maintenance/economic incentives).

Example plants.

Plants 121 and 142.

Reference literature

No information provided.

3.2.2.6 Techniques to prevent and/or reduce HCl and HF emissions

3.2.2.6.1 Co-benefit of techniques designed for other pollutants

This section discusses the halide removal efficiency of the various pollution control technologies most commonly installed in LCPs (i.e. particulate and sulphur control equipment).

Description

Reduction of halide emissions as a co-benefit of abatement techniques designed for removing other pollutants.

Technical description

Very little information is available regarding the capture of halides by electrostatic precipitators (ESPs) and bag filters alone. Considering the nature of the gases, however, in the absence of a sorbent, it is likely that they have little or no effect. The addition of a sorbent such as lime to the combustion zone can result in the capture of halides on or in particles, which may then be trapped by filtration systems. With dry sorbent injection in the combustion chamber, HCl and HF reduction is limited as SO₂ reduction releases HCl and HF from the sorbent at high temperatures.

A common dry FGD system for both utility and industrial boilers is the spray dryer (semi-dry system). The flue-gas comes into contact with an atomised lime slurry or sodium carbonate solution. The hot flue-gases dry the droplets and precipitate the dissolved chemicals, which can then be collected, along with any remaining boiler fly ash in a bag filter or ESP. Other dry systems such as dry sorbent injection or the CFB scrubber can be used for reducing halide emissions, for instance as a second abatement step for HCl and HF, including in a CFBC system of > 300MW_{th}.

In wet FGD systems, flue-gases can be initially washed in a pre-scrubber, which stops the potential build-up of chlorides in the FGD absorber circulation loop. In the pre-scrubber, most of the fly ash and soluble gases such as HCl and HF are captured and the effluent is removed to a waste water treatment plant.

SCR and SNCR are technologies designed to remove NO_x from flue-gases. In SNCR, the ammonia used to reduce NO_x can react with HCl and HF in the fly ash to produce ammonium chloride and fluoride. It may be assumed that if an ESP or other particulate controls are in place, the ammonia may still react with any HCl/HF in the flue-gas, although this effectively neutralises the acidity of the HCl/HF.

Achieved environmental benefits

Reduced HCl and HF emissions.

Environmental performance and operational data

The actual halide removal efficiency of combustion plants using a wet FGD system varies greatly. The chlorine (HCl) removal efficiency ranges from 87 % to 97 %, fluorine (HF) from 43 % to 97 %, bromine from 85 % to 96 % and iodine from 41 % to 97 %. When using a rotating heat exchanger, the highest removal efficiencies cannot be reached due to the adsorption/desorption of halides to/from the heat exchanger surface (material).

Chlorine and fluorine removal efficiencies in dry FGD systems are equivalent to those of wet FGD systems. [148, CIEMAT 2000]

Cross-media effects

When using SCR/SNCR techniques, the ammonium chloride produced can lead to visible plumes at stack level.

Technical considerations relevant to applicability

See Section 3.2.2.2.

Economics

See sections on corresponding techniques.

Driving force for implementation

No information provided.

Example plants

See sections on corresponding techniques.

Reference literature

[148, CIEMAT 2000]

3.2.2.6.2 Wet scrubbing**Description**

Use of a liquid, typically water or a water-based solution, to capture the acidic gas by absorption from the flue-gas.

Technical description

HCl/HF is scrubbed using either a venturi scrubber, with the mixing of liquid and gas streams enabling the transfer of HCl/HF from the gas phase to the scrubbing liquid phase, or a counter-current packed tower for achieving higher efficiencies.

The scrubbing liquid typically contains a reactive agent that neutralises the acid absorbed, making the small amount of liquid effluent from the scrubber relatively easy to dispose of or to treat in existing waste water treatment facilities.

Achieved environmental benefits

Reduced HCl and HF emissions.

Environmental performance and operational data

A single-stage ejector venturi gas scrubber can typically achieve a 95 % HCl removal efficiency. A counter-current packed tower is used to achieve HCl removal efficiencies up to and exceeding 99.9 % and is typically used in waste incineration plants.

Table 3.35 provides technical information related to the wet scrubbers mainly used in the incineration sector for reducing halide emissions.

Table 3.35: Plant data of HCl scrubbers implemented at waste incineration facilities

Flue-gas flow rate	Unit	System 1	System 2	System 3	System 4
	Nm ³ /h	92 000	70 000	85 640	131 000
Scrubber inlet temperature	°C	170	170–250	169	220
Scrubber type		Two-stage spray tower scrubber	Venturi quench / spray tower, without internals	Two-stage spray tower scrubber, without internals	Venturi scrubber, without internals
Gas-liquid routing		Co-current	Co-current	Co-current	Co-current
Diameter	m	3.8 / 4	3.40	3.80	5.00
Scrubber height	m	10.4 / 11.8	17.6 (incl. quench)	29.60	8.25
Number of spraying levels		1 / 1	1 / 1	1 / 1	1
Scrubbing liquid circulation rate	m ³ /h	1 000	225 / 450	1 064 / 880	350
pH in scrubber sump		0.5	0.8	0.4	0.5–0.7
Flue-gas-side pressure drop	hPa	10	6	2.1	12
Type of reagent		Water	Ca(OH) ₂	Water	Ca(OH) ₂
Raw gas before scrubber (nominal daily average - HCl)	mg/Nm ³	1 200	1 100	1 040	1 140
Clean gas after scrubber (nominal daily average - HCl)	mg/Nm ³	NA	4	60	20
Raw gas before scrubber (nominal daily average - HF)	mg/Nm ³	13	20	53	17
Clean gas after scrubber (nominal daily average - HF)	mg/Nm ³	NA	1.5	4	2

Source: [30, VDI 2013]

Cross-media effects

Waste water generation.

Technical considerations relevant to applicability

No information provided.

Economics

No information provided.

Driving force for implementation

No information provided.

Example plants

Plant 470V.

Reference literature

[30, VDI 2013] [31, CHIRONNA 2011]

3.2.2.7 Techniques to reduce unburnt carbon

3.2.2.7.1 Combustion optimisation

See also Section 3.1.7.

Description

Measures taken to maximise the efficiency of energy conversion, e.g. in the furnace/boiler, while minimising emissions (in particular of CO). This is achieved by a combination of techniques including good design of the combustion equipment, optimisation of the temperature (e.g. efficient mixing of the fuel and combustion air) and the residence time in the combustion zone, and/or use of an advanced control system.

Technical description

The technique includes the good design of the furnace, combustion chambers, burners and associated devices and the regular planned maintenance of the combustion system according to suppliers' recommendations.

Achieved environmental benefits

Reduction of NO_x, N₂O, NH₃ (when SCR and/or SNCR are used), CO and other unburnt emissions to air in a balanced way.

Technical considerations relevant to applicability

There are techno-economic limitations in the possibilities to improve the boiler design.

3.2.2.7.2 Oxidation catalyst

Description

Use of catalysts (that generally contain precious metals such as palladium or platinum) to oxidise carbon monoxide (CO) and unburnt hydrocarbons (UHC) to form CO₂ and water vapour.

Technical description

The catalytic oxidation system can be installed in the gas turbine/engine exhaust.

The oxidation reaction between oxygen and carbon monoxide and unburnt hydrocarbons, which is enhanced by the catalyst, occurs at 500 °C and above to form carbon dioxide. Oxidation catalysts suitable for short chain alkanes (CH₄, C₂H₆, C₃H₈,) are still in development stage for gas engines, see Section 11.6.1.2.1 for more information.

The principle of operation for the catalytic converter is a chemical reaction dependent only on temperature and which requires no control instruments (the maximum exhaust temperature to be considered is around 560 °C).

The oxidation catalyst is assembled in modules. Each module is formed by a special stainless steel foil, corrugated and folded back and forth upon itself to make a honeycomb core. The core is encased in a stainless steel enclosure measuring approximately 0.4 m². The modules are fitted into an internal support frame made of carbon steel. Expansion seals on the outside of the internal support frame ensure that the exhaust passes through the catalyst. The expansion seals also accommodate thermal expansion. The above-mentioned components are installed in an external support structure which serves as a duct spool piece.

This catalyst structure is constructed of carbon steel with a stainless steel liner over the insulation, and has an access point on one side wall. The access point is for installation and removal of catalyst modules.

The converter duct spool is also equipped with a series of gas ports for access to measure total and static pressures for developing a velocity profile. These ports can also be used to take samples from the front and back of the converter, or to mount any customer-supplied instruments.

Test catalyst cores or 'buttons' (cylinders of about 8 cm in diameter) are located in various catalyst modules. The test catalyst buttons are mounted for easy replacement from time to time for lab testing.

Achieved environmental benefits

CO and unburnt hydrocarbon reduction in emissions to air.

Environmental performance and operational data

At maximum load, in the case of a natural-gas-fired gas turbine/engine, the typical reduction efficiency is about 90 %, being higher when the load decreases.

The typical useful lifetime is about 40 000 operating hours.

Cross-media effects

- Waste generation when the catalyst has to be replaced;
- Increase in CO₂ emissions.

Technical considerations relevant to applicability

The oxidation catalyst needs a maximum upstream flow rate variation of about +/-15 %. For this reason, perforated plates, guide vanes or straightening grids are necessary to uniform the flue-gas velocity. Consequently the flue-gas duct should have the required space not only for the catalyst module but also for the other devices.

The maximum flue-gas temperature is limited to about 560 °C.

Economics

No information provided.

Driving force for implementation

Regulation.

Example plants

Plant 162, 164, 195, 196, 295 and 296.

Reference literature

No information provided.

3.2.3 Techniques to increase energy efficiency

3.2.3.1 Heat recovery techniques

Description

Recovery of heat lost from all combustion and energy generation processes, to avoid such heat being wasted and to efficiently use the fuel's energy content.

Technical description

Different techniques can be implemented to recover and use the heat, depending on the combustion process, combusted fuel and/or configuration of the installation:

- combined cycle combustion (see Section 3.2.3.11);
- combined heat and power production (see Section 3.2.3.2);
- feed-water preheating (see Section 3.2.3.7);
- fuel drying/preheating (see Section 3.2.3.18);
- combustion air preheating (see Section 3.2.3.4);
- flue-gas temperature decrease;
- flue-gas condenser (see Section 3.2.3.15);
- cooling grate (see Sections 2.2.4 and 5.2.3.3);
- heat recovery from recirculated bed materials.

Achieved environmental benefits

Increased energy efficiency.

Environmental performance and operational data

See related information in each specific section of this BREF.

Cross-media effects

See related information in each specific section of this BREF.

Technical considerations relevant to applicability

See related information in each specific section of this BREF.

Economics

See related information in each specific section of this BREF.

Driving force for implementation

See related information in each specific section of this BREF.

Example plants

See related information in each specific section of this BREF.

Reference literature

See related information in each specific section of this BREF.

3.2.3.2 Cogeneration or combined heat and power (CHP)**Description**

Cogeneration is the recovery of heat (mainly from the steam system) for producing hot water / steam to be used in industrial processes/activities or in district heating. Additional heat recovery is possible from:

- the flue-gas;
- grate cooling;
- the circulating fluidised bed.

Technical description

Cogeneration is a means of improving the energy efficiency by influencing the energy supply system structure.

The heat from the combustion plant (e.g. turbine, engine) flue-gases may be used for steam production in a recovery boiler (also called heat recovery steam generator) or be extracted partially (or sometimes fully) and used for steam supply to consumers, who can then use the steam in their own processes or for other purposes such as district heating or seawater desalination.

There are many possible configurations to meet the specific plant requirements. For example in the case of gas turbines, depending on the demand for heat and power, the most common are the following:

- Gas turbine with a heat recovery steam generator and supply of all the generated steam to steam consumers.
- Gas turbine with a heat recovery steam generator with a back-pressure steam turbine, and supply of all the generated heat to steam consumers.
- Gas turbine with a heat recovery steam generator with steam extractions to consumers and/or the use of extraction steam for other heating purposes and a vacuum steam condenser. This design usually gives more flexibility in the power to heat ratio.
- Steam-injected gas (STIG) cycles in which steam is also generated by the exhaust heat but partly injected to the gas turbine. These are used primarily with aeroderivative gas turbines without the application of a steam turbine. These cycles are mainly applied in cogeneration applications with intermittent process steam demands.

An important measure of a cogeneration power plant is its power to heat output ratio. Because electric power can be more economically valuable than heat, it is preferable to have as high a power to heat ratio as possible, in combination with a low overall heat rate.

A CHP-ready plant includes the measures taken to allow the later export of a useful quantity of heat to an off-site heat load in a way that will achieve at least a 10 % reduction in primary energy usage when compared to the separate generation of the heat and power produced. This includes identifying and retaining access to specific points in the steam system from which steam can be extracted, as well as making sufficient space available to allow the later fitting of items such as pipework, heat exchangers, extra water demineralisation capacity, standby boiler plant and back-pressure turbines. Balance of Plant (BoP) systems and control/instrumentation systems are suitable for upgrade. Later connection of back-pressure turbine(s) is also possible. More information on CHP readiness is given in Section 7.1.3.1.3.1

Further information on cogeneration is given in Sections 3.1.1.1 and 2.5.

Achieved environmental benefits

One benefit is energy efficiency improvement.

For baseload applications, cogeneration can save fuel compared to the separate generation of heat and power from fossil fuels.

Advantages of a cogeneration system include [213, COGEN 1999]:

- high overall energy efficiency;
- CO₂ reduction possible in comparison to separate generation of heat and power.

Environmental performance and operational data

In cases where, for steam turbine-based power processes, the cooling of the steam turbine condenser is provided by the district heating network, fuel utilisation rates of 75 % to 95 % can

be reached on a yearly basis, and a significant reduction of emissions of greenhouse gases, NO_x, SO_x and particulates can be achieved, compared with the separate production of power and heat. The fuel to electric power conversion rate is however somewhat lower in these plants than at plants producing only power, because of the higher condensing temperature at the turbine condenser, which in this case is the district heat exchanger. The high total efficiency achieved, however, by far supersedes this lower electrical output.

At a condensing CCGT, two thirds of the power output comes from the gas turbine, and the cogeneration-related power loss only occurs in the steam turbine producing the other third of the output. The power to heat output ratio of a CCGT at nominal load can be 1.1 in district heating applications and 0.9 in the pulp and paper industry, while the figures in steam-only cogeneration are 0.6 and 0.3 respectively. The annual average figures are typically clearly lower, due to, among others, part-load operation and start-up/shutdown cycles.

CHP plants can be optimised so that they can flexibly respond to changing heat and power demands.

Table 3.36: Indicative comparison of cogeneration with separate power and heat generation

	Power generation heat rate ⁽¹⁾	Power to heat ratio ⁽²⁾	Total cogeneration system heat rate ⁽³⁾	Separated system heat rate; coal ⁽⁴⁾	Separated system heat rate; CCGT ⁽⁵⁾
Conventional coal condensing	2.3	NA	NA	NA	NA
CCGT condensing	1.8	NA	NA	NA	NA
Industrial conventional cogeneration ⁽⁶⁾	5.0	0.28	1.1	1.36	1.25
Industrial CCGT cogeneration	2.4	0.9	1.15	1.67	1.43
DH conventional cogeneration	2.9	0.6	1.1	1.55	1.36
DH CCGT cogeneration	2.1	1.1	1.1	1.73	1.47
Heat only boilers/coal	NA	NA	1.1	NA	NA
Heat-only boilers/HFO	NA	NA	1.1	NA	NA
Heat-only boilers/gas	NA	NA	1.07	NA	NA

⁽¹⁾ Fuel input (LHV)/Net power output.
⁽²⁾ Net heat output/Net power output.
⁽³⁾ Fuel input (LHV)/(Net power + heat output).
⁽⁴⁾ Combined heat rate of producing separately in conventional coal condensing plants and heat-only boilers (HR = 1.1) the same amounts of power and heat as in the cogenerating system. To be compared with the HR indicated in row 3.
⁽⁵⁾ Combined heat rate of producing separately in CCGT condensing plants and heat-only boilers (HR = 1.1) the same amounts of power and heat as in the cogenerating system. To be compared with the HR indicated in row 3.
⁽⁶⁾ Live steam 80 bar 480 °C; back-pressure 4 bar.
 All figures refer to nominal full load operation.
 NB:
 NA: Not available.
 Source: [130, Finland 2000]

In Figure 3.51, the total system heat rates (the final three columns on the right) are comparable in each row. They indicate how much fuel is needed in a cogeneration system and in a system with the same power and heat outputs but with heat and power generated separately. It can be seen that, in each case, the separated system – whether conventional or CCGT-based – clearly consumes more fuel than the cogeneration system providing the same energy service. When the comparison basis is conventional condensing power, the reduction in fuel consumption by cogeneration ranges from 20 % for conventional industrial cogeneration to 57 % for district heating CCGT cogeneration. If CCGT condensing is assumed for the separate power generation, the savings are smaller, 12 % and 34 % respectively. These figures are quoted only to give a

general idea of fuel savings through cogeneration; the actual figures always depend on the specifics of each project and the energy supply system of which it is a part.

In general, the combined production of electricity and heat saves approximately 3 to 20 percentage points of primary energy compared with the separate production of electricity and heat. However, with the combined production of electricity and heat, it is important that the heat sink can be operated, and the power consumed, all whole year long. If the heat sink or power consumption with combined products (during summer months heat consumption is mostly used for a relatively small amount of hot water production only) are not available, it might be possible that the annual thermal utilisation efficiency of the 'combined heat and power plant' (annual efficiency factor) compares unfavourably with the temporary (six-monthly) production of heat in a separate boiler combined with the separate power production in a power plant producing electricity only. In this case, the CHP plant might produce more CO₂ for the production of the same amount of heat and power than the production in separate plants, e.g. heat in a gas-fired boiler and power in a high-efficiency power plant.

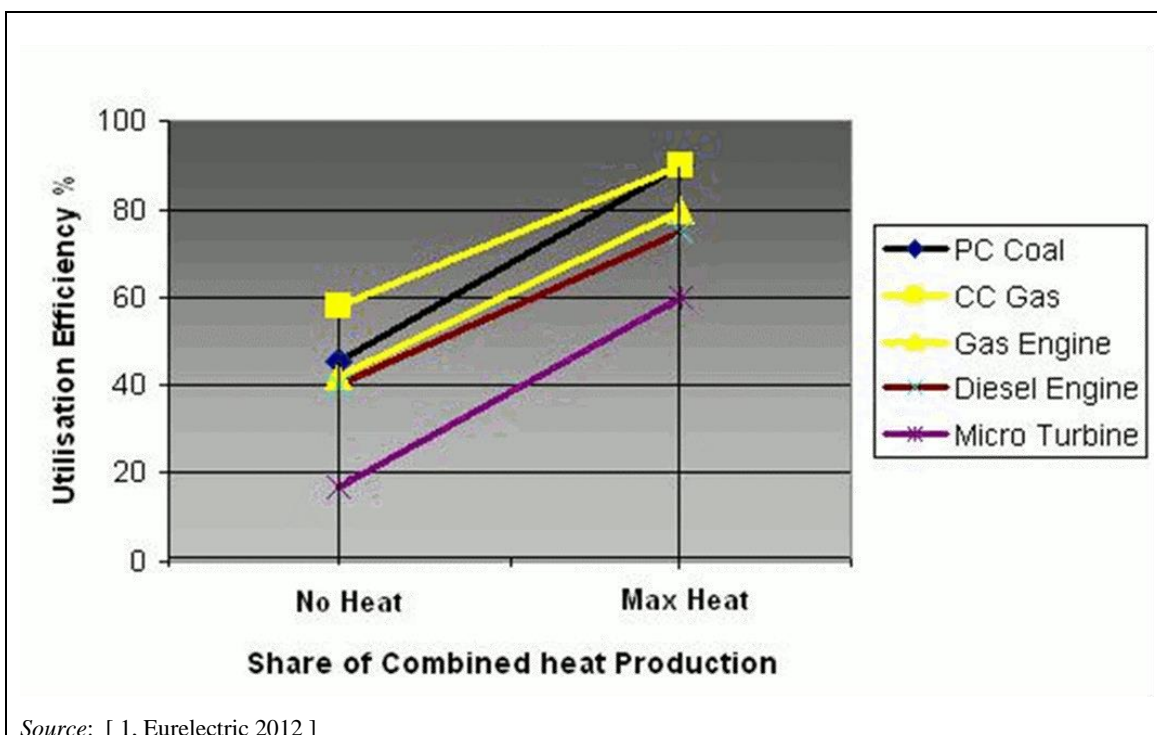

Figure 3.51: Influence of heat production on utilisation efficiency in a CHP plant

A district heating system is an entity where emissions are minimised at the system level. Baseload CHP plants are dimensioned in such a way that the yearly CHP usage is high and an overall yearly efficiency of 80–90 % (heat + electricity) can be reached. Peak load units operate only tens or hundreds of hours a year. For large cities located in cold climate regions, this system replaces thousands of separate very small domestic combustion units.

The nominal CCGT efficiency in the Termica Cologno (IT) combustion unit (Plant 292) is 50.7 % (full condensing asset without post-combustion), and 81.3 % (cogenerative asset without post-combustion). Load factor (average CCGT load 90 %), age degradation and variable thermal heat demand from the utilities have an impact on the design values: Reported yearly net efficiencies for 2010 are 43.8 % for net electrical efficiency and 53.8 % for total fuel utilisation.

Cross-media effects

The disadvantages of a cogeneration system are [213, COGEN 1999]:

- high heat to power ratio;
- high cost.

Plant operation depends on the demand for electricity and hot water. Hot water production is needed to supply the district heating networks. Therefore it may be necessary to change the operating modes (full/partial load) in the short term. Short-term changes can move emission values to a higher level.

For heat recovered from the flue-gas, care should be taken to consider corrosion issues (the flue-gas temperature should be a minimum of 20 °C above the acid dew point).

Technical considerations relevant to applicability

This technique is generally applicable for new plants, with locations near a heat demand to be favoured. It is also applicable for existing plants where there is an existing heat demand available near the combustion plant.

In particular, district heating is applicable for areas where there is a demand for heating.

From the technical point of view, all combustion plants can be modified for cogeneration.

The applicability may be limited in the case of gas compressors with an unpredictable operational heat profile.

Economics

For cogeneration to compete successfully in the market, a high electricity price and a sufficient local heat demand are required. For a small heat demand, the plant size may be under the limit of economic competitiveness. Big local industrial heat loads typically exist in the pulp and paper industry, in refineries and in the chemical industry and, in some cases, in the food and textile industries.

A relatively steady heat load is a prerequisite for effective and economical operation of a combined heat and power plant. District heating can provide fairly steady heat loads for a large part of the year in a cold climate.

Driving force for implementation

Replacement of old combustion plants / steam turbines by power plants with higher production yields, when there is a possibility for a combined generation of electricity and steam/hot water for process/heating purposes.

Example plants

Plants 49, 111 (district heating).

Plant 149-1 (CHP for chemical production and power plant).

Plant 292 (CHP for paper mill and district heating).

Plant 24 (retrofit to be included in a district heating network).

Reference literature

No information provided.

3.2.3.3 Cheng Cycle

Description

Steam is generated in gaseous-fuel-fired gas turbines by means of an open-cycle steam circuit, by recovering heat losses from the flue-gas. The generated steam is then injected into the combustion chamber, to increase the turbine output and energy efficiency and to reduce NO_x emissions by cooling down the flame.

Technical description

In the 'Cheng Cycle', the heat of the exhaust gases from a gas turbine is used for steam generation on one pressure level, which is fully injected into the gas turbine, increasing the power output. As the steam will achieve the same pressure and temperature as the flue-gas in the combustion chamber, the increase in power output will be greater than with a combined cycle.

In practice the Cheng Cycle is applied in combined heat and power (CHP) units providing a normal steam supply to users with a varying heat demand. In situations where no or less heat is required, the generated steam can be used for electric power generation by injecting it directly into the gas turbine, increasing the power output by 50–70 % in this mode, without a supplementary steam turbine. [123, Eurelectric 2001]

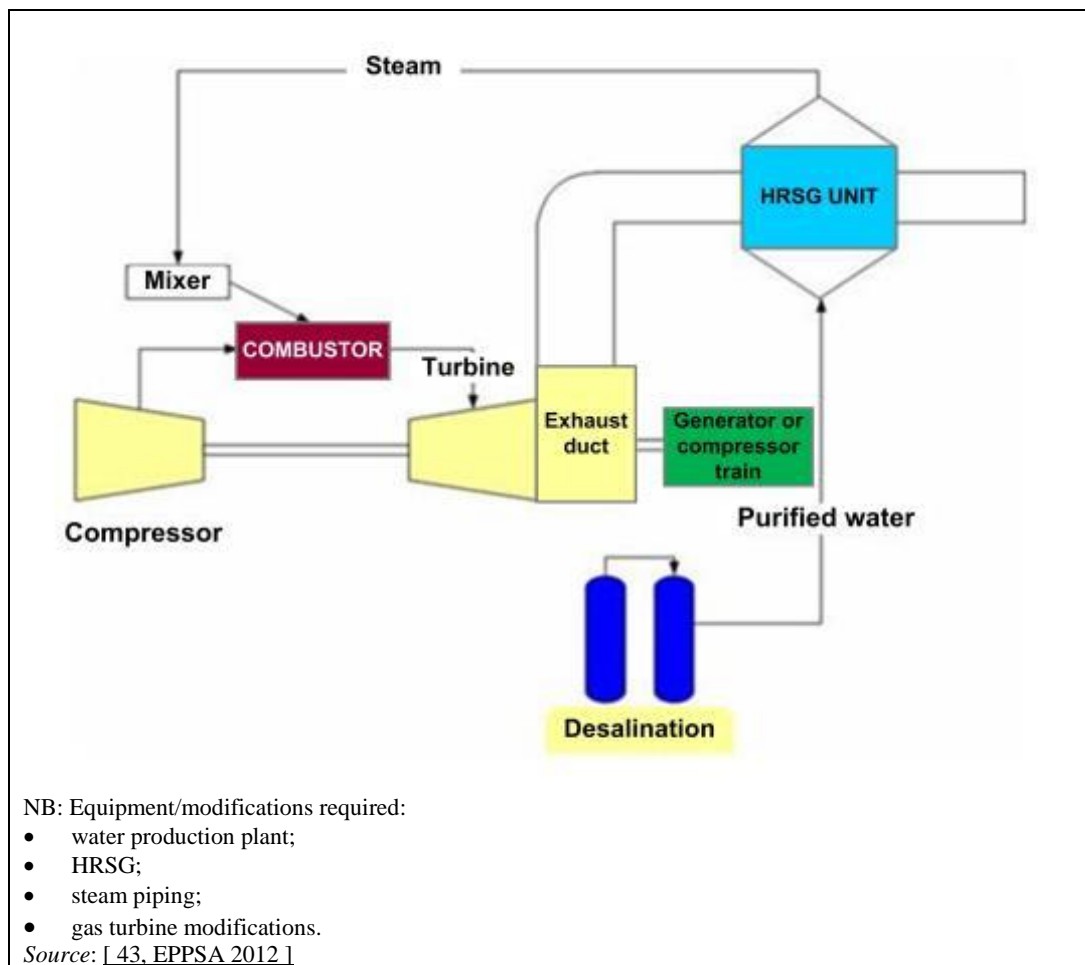

Figure 3.52: Principle sketch of the Cheng Steam Injection Cycle

Achieved environmental benefits

- NO_x reduction (up to 95 %).
- No penalty in terms of increased CO associated with steam injection.
- Higher steam to fuel ratio possible than other steam injection technologies.
- Increase in thermal efficiency, up to 45 %, which reduces CO₂ emissions per kWh produced.
- Contrary to other steam injection concepts, the Cheng Cycle also features a unique control system that allows the power plant peak (maximum) thermal efficiency to follow load changes. This makes it very suitable for offshore installations, where the turbine load is not constant.

Environmental performance and operational data

A turbine efficiency of more than 50 % at a turbine inlet temperature of 1 200 °C is calculated. The efficiency increases with the decreasing compressor ratio. The Cheng Steam Injection Cycle technique provides unique mixing of gaseous fuel and steam, so that NO_x can be reduced by up to 95 %, with no significant increase in CO emission.

Table 3.37: Achieved NO_x emissions and thermal efficiencies for conventional combustor turbines with modified fuel nozzles

Steam/fuel ratio	Achieved NO _x level (ppm)	Thermal efficiency
0	Standard configuration	34.5
1.5	25	39
3	7	44

The Cheng Steam Injection Cycle can be used at all operational loads. When needed, the steam injection can simply be turned off during operation. The only effect will be higher NO_x emission rates and increased fuel consumption in order to maintain the same power output level.

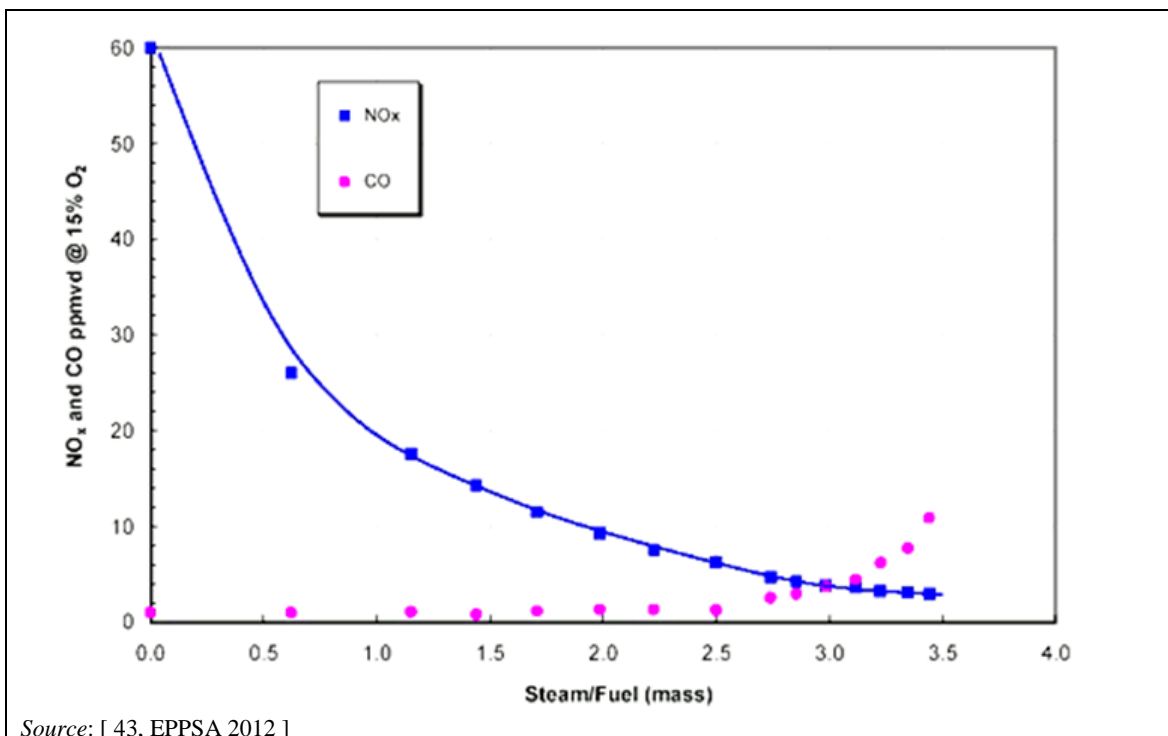

Figure 3.53: NO_x and CO emission as a function of steam ratio

The Cheng Steam Injection Cycle is utilised at about 100 installations in Japan, the US and Europe. The technology can, in general, be applied on all gaseous-fuel-fired turbines with conventional combustion (diffusion flame technology).

Cross-media effects

Make-up water is required for the steam generation, which has to be considered as an overall loss because it is discharged to air together with the exhaust gases.

Technical considerations relevant to applicability

Generally applicable.

Economics

Less expensive than a dry low-NO_x (DLN)/combined-cycle retrofit.

Calculation example:

- installed power: 3 x 22 MW each, 66 MW total;
- one HRSG installed in the exhaust duct of one gas turbine produces steam for three turbines;
- steam to fuel ratio of 2.5;
- reduction of NO_x to < 10 ppm;
- additional costs for support structure for the installation on an offshore platform needs to be taken into account.

Table 3.38: Costs and weight for a Cheng steam injection cycle on a GE LM 2500 package

	Cost (million NOK)	Weight (t)
Gas turbine rebuild	30	~1
HRSG	10	30
Desalination plant for water production	6	16

Driving force for implementation

- Retrofit to the Cheng Cycle is possible for all gas turbines with conventional combustion technology (diffusion flame combustor).
- Little space is required in the gas turbine package for modification. Therefore, emission levels lower than dry low-NO_x emissions systems (DLE)/DLN can be achieved in offshore installations that are not prepared for DLE/DLN turbines.
- Retrofit and maintenance costs are lower than for the DLE/DLN available.
- A conventional combustion system with Cheng steam injection has a higher availability than DLE/DLN, hence it is more applicable to gas compression trains.
- Emissions lower than DLE/DLN without CO/unburnt hydrocarbon trade-off.
- Many offshore installations already have a HRSG, which lessens the need for modifications and investment and results in lower installation costs.
- Increased power output or reduced fuel consumption.

Example plants

No information provided.

Reference literature

[272, Wang et al. 2002] [273, Sahai et al. 2003] [274, Cheng et al. 2002] [275, Cheng 1997]

3.2.3.4 Combustion air preheating

Description

Preheating of combustion air by heat recovered from the process/flue-gas.

Technical description

Preheating of combustion air by heat recovered from the process/flue-gas. This enables transferring enthalpy to the combustion chamber, thus reducing the fuel consumption and improving the energy efficiency.

Achieved environmental benefits

Increased energy efficiency.

Environmental performance and operational data

High operational experience.

Cross-media effects

Thermal NO_x generation can be increased.

Technical considerations relevant to applicability

Applicable within the constraints associated with the NO_x emissions control.

Economics

This technique is only economical if there is a good low-value heat source available (e.g. process waste heat, vented low-pressure steam).

Driving force for implementation

No information provided.

Example plants

Plant 539.

Reference literature

No information provided.

3.2.3.5 Advanced material use**Description**

Use of advanced materials able to operate at high temperatures for increased turbine (gas/steam) efficiencies.

Technical description

In natural gas (NG) and integrated gasification combined-cycle (IGCC) power plants, the combustion takes place with excess air, lowering the flame temperature from about 2 000 °C to ~1 400–1 500 °C, so that it can be used in a Brayton cycle gas turbine. In conventional coal plants, the heat is lowered to ~600°C, so it can be used in steam turbines. This downgrading of the heat quality is counterintuitive to a major objective in the power industry, which is to raise the hot-side temperature as much as possible so that the efficiency can be higher. The reason for rejecting the highest heat quality is because of the lack of materials with high enough mechanical strength and durability at such extreme temperatures to be used for turbo-machinery components.

Achieved environmental benefits

Increased energy efficiency.

Environmental performance and operational data

Data are available for newly built plants; they are combustion process/fuel-specific.

For coal- and/or lignite-fired plants, using advanced materials enables steam pressures of up to 300 bar and steam temperatures of up to 600 °C to be reached.

Cross-media effects

None.

Technical considerations relevant to applicability

Applicable for new plants.

Economics

The main limitation of advanced materials is the high cost of such new materials.

Driving force for implementation

No information provided.

Example plants

No information provided.

Reference literature

No information provided.

3.2.3.6 Steam double reheating

Description

Improved plant performance is possible by a double, rather than single, steam reheat cycle.

Technical description

The benefit of using the double reheat cycle is further enhanced by the feasibility of using ultra-supercritical pressures and temperatures.

Achieved environmental benefit

Increased thermal efficiency.

Environmental performance and operational data

No information provided.

Cross-media effects

No information provided.

Technical considerations relevant to applicability

Only applicable for new plants.

Economics

No information provided.

Driving force for implementation

No information provided.

Example plants

Plant 191.

Plant 34 (Nordjyllandsværket 3).

Reference literature

No information provided.

3.2.3.7 Feed-water preheating using recovered heat

Description

Preheating water from the steam condenser with recovered heat before reusing it in the boiler.

Technical description

In steam power and CHP plants, the steam condensate stream that was cooled down by the condenser is reheated using either a steam stream extracted between the stages of the steam turbines or heat extracted from the flue-gas downstream of the air preheater of the boiler. The delivered heat remains, however, inside the system.

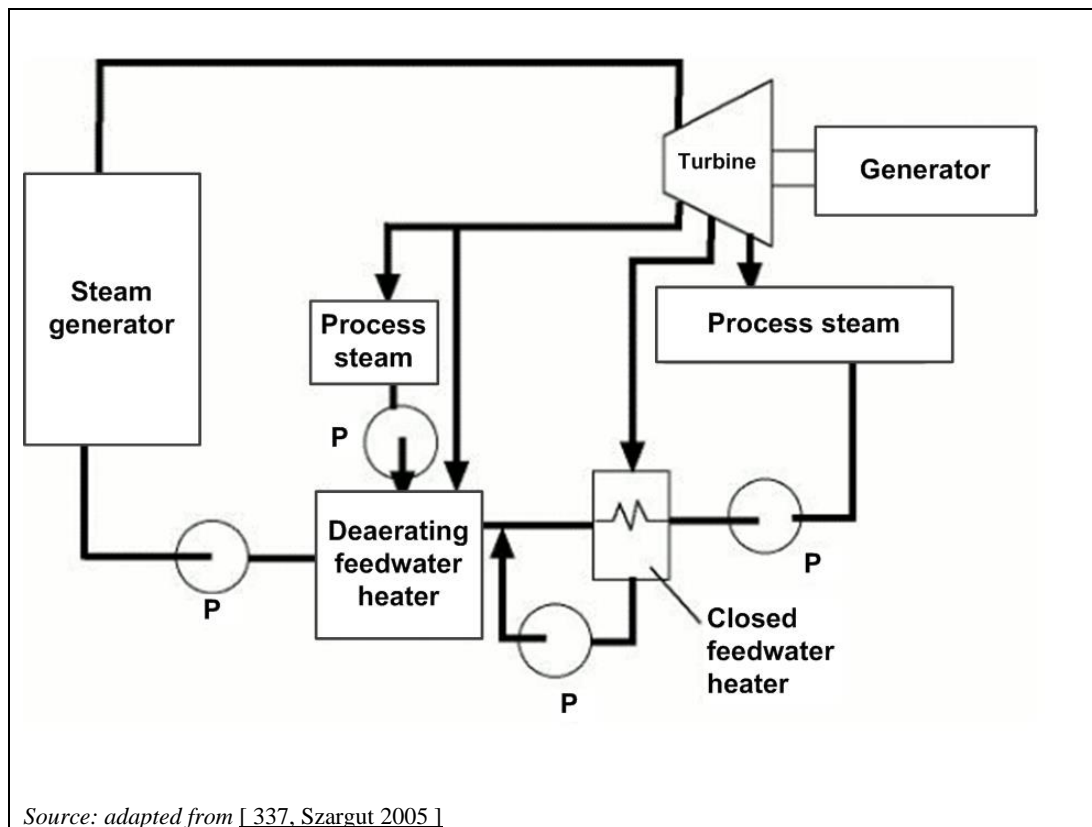

Figure 3.54: Feed-water preheating

Achieved environmental benefits

Increased thermal efficiency.

Environmental performance and operational data

- Increase in electrical efficiency in turbines of 0.8–0.9 percentage points.
- Feed-water preheating in coal- and/or lignite-fired plants can be made up of up to 10 stages, resulting in a feed-water temperature of about 300–320 °C.
- Plant 191 (GT) has a heat recovery steam generator with a triple pressure reheat design, with a feed-water preheating circuit. This results in a low flue-gas temperature (approximately 75 °C) at the stack and correspondingly less stack losses.

Cross-media effects

If heat is recovered from the flue-gas, there is a risk of corrosion due to the possible condensation if the flue-gas temperature is too low. The latter should be kept at a minimum of 20 °C above the acid dew point.

Technical considerations relevant to applicability

Only applicable to steam circuits and not to hot boilers.

Applicability to existing units may be limited due to constraints associated with the plant configuration and the amount of recoverable heat.

Economics

No information provided.

Driving force for implementation

No information provided.

Example plants

Plant 191.

Reference literature

No information provided.

3.2.3.8 Advanced control system

Description

Combustion efficiency can be improved by using computer-based automatic systems, which includes the use of high-performance monitoring. This improvement minimises the heat loss due to unburnt gases and to elements in solid wastes and residues from combustion, e.g. through the slag. Boiler efficiency is optimised, and unburnt substances and NO_x generation are reduced.

Technical description

Varying combustion conditions and fuel quality, together with changing loads, upset combustion. As a result, the boiler efficiency can decrease, and flue-gas emissions and oxygen levels increase. Advanced computerised control systems improve the combustion efficiency, acting on/considering the following variables:

- combustion temperature;
- inlet air excess;
- temperature profile;
- temperature at the combustion chamber outlet;
- flue-gas oxygen content;
- NO_x/CO balance;
- fuel feeding;
- steam pressures in the whole steam network;
- air to fuel ratio at each burner or row of burners.

Acting on and monitoring these parameters allows the combustion to be enhanced, thus improving the thermal efficiency, reducing the unburnt carbon-in-ash, and reducing the CO and NO_x concentrations in the flue-gas.

The emissions of unburnt gases, which can be divided into two main groups: carbon monoxide (CO) and hydrocarbons (C_xH_y), can be reduced by advanced combustion techniques. Emissions of CO and unburnt hydrocarbons are a consequence of incomplete combustion and can be caused by excessively low combustion temperatures; too short a residence time in the combustion zone; or by inefficient mixing of the fuel and combustion air, leading to local areas of oxygen deficiency.

Carbon monoxide is the most important unburnt gas. It is a stable compound even at high temperatures if there is no oxygen present. Hydrocarbons, on the other hand, can be decomposed and form soot at high temperatures in an oxygen-poor atmosphere. In general, emissions of unburnt hydrocarbons may be generated when a low combustion temperature zone and inefficient mixing of fuel and air occur together. However, such conditions are rare in large modern combustion plants.

Engines and turbines may be equipped with catalytic converters (generally precious metals such as palladium or platinum), where an oxidising reaction converts carbon monoxide (CO) and unburnt hydrocarbons (UHC) to CO₂ and water vapour, using the O₂ contained in the flue-gas:

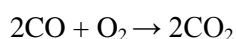

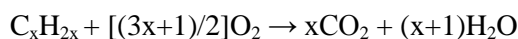

A palladium-based catalyst is very sensitive to impurities in the flue-gas (thus natural gas or clean distillate oil are prerequisites) and may deactivate fast. The NMVOC reduction rate depends on the level of hydrocarbon compounds in the flue-gas. The shorter chain alkanes, methane, ethane and propane, are stable molecules and difficult to oxidise (methane is the most difficult, then ethane and then propane).

Emissions of unburnt gases are affected by several parameters. Typically, the emissions of unburnt gases are highest when there are problems controlling the fuel to air ratio in the combustion chamber or when the fuel quality is not homogeneous (as is the case with waste or biomass). Coals with low reactivity and volatile content (anthracites) tend to increase the emissions of unburnt gases. Higher emissions can also be a consequence of a low combustion temperature, caused by using a low-rank fuel, partial loading, or through malfunction of the burner.

Some measures to reduce NO_x emissions, such as combustion with lower excess air or strong air staging, can increase emissions of the unburnt gases. In these cases, the importance of ensuring efficient mixing of air and fuel in the combustion system must be emphasised. NO_x reduction with the SNCR method can also cause higher CO emissions. CO emissions can be decreased when limestone feeding is increased in fluidised bed combustion boilers.

Similarly to the costs of NO_x reduction, it is impossible to separate the cost of these measures from the total investment. If there are problems with unburnt gases in an existing power plant, the case has to be assessed separately, and the possible expenses clearly set out in a feasibility evaluation.

The use of primary measures, either for coal or lignite, tends to cause incomplete combustion, resulting in a higher level of unburnt carbon in the fly ash and some carbon monoxide emissions. With a good design and control of combustion, these negative impacts can mostly be avoided. The amount of unburnt carbon-in-ash varies according to the fuel and is normally somewhat higher than without primary measures. For most of the utilisation options for the fly ash, the level of unburnt carbon-in-ash is below 5–10 %. Levels of unburnt carbon below 5 % can normally be achieved, but with some coals only at the cost of somewhat higher NO_x emissions. Primary NO_x reduction measures also have an impact on the total energy efficiency of the process. If the combustion remains incomplete, the energy efficiency remains lower. A normal rise in the amount of unburnt carbon due to low-NO_x combustion has a negative impact of approximately 0.1–0.3 percentage points on the unit efficiency.

The boiler efficiency and NO_x generation depend largely on the correct distribution of fuel and air in the combustion chamber. An efficient control system allows gas concentration measurements to be taken in the interior areas of the combustion chamber, especially near the burners.

Figure 3.55 shows the principles of an advanced control system applied to a 60 MW_{th} biomass-fired boiler.

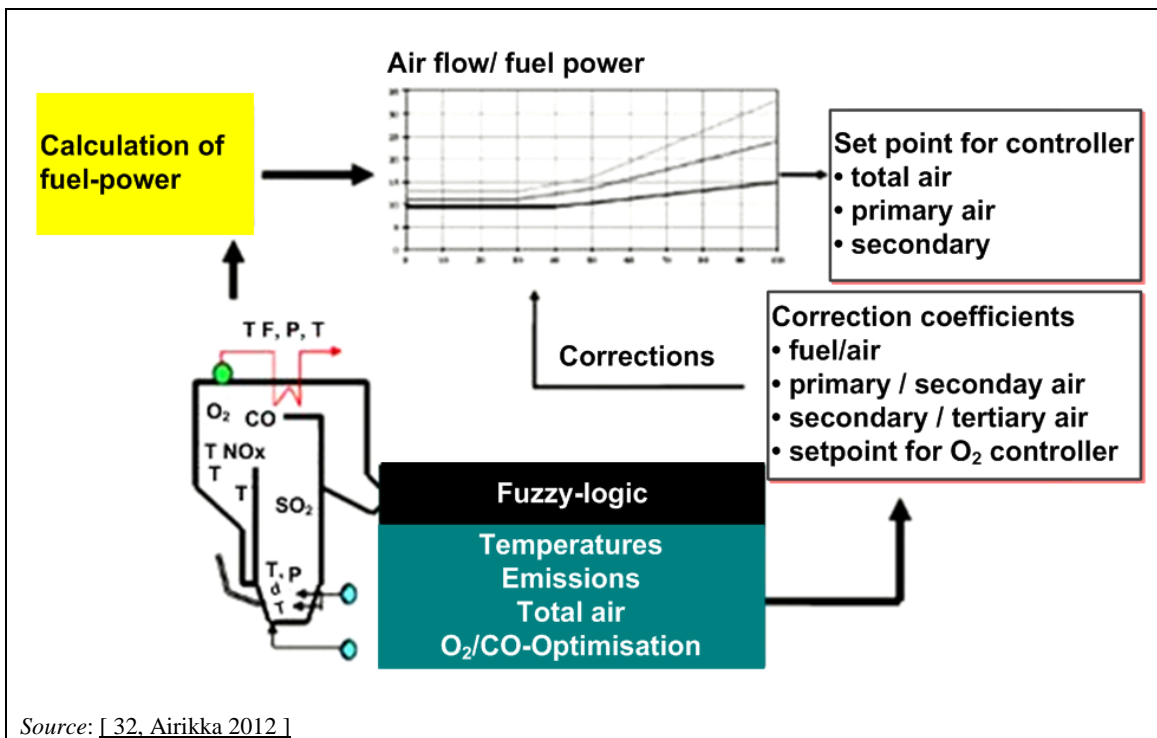

Figure 3.55: Advanced control system applied at the Billerud AB Karlsborg plant, Sweden

Achieved environmental benefits

- Increased thermal efficiency.
- Air pollutant emission reduction (NO_x, CO, TOC).
- Low unburnt carbon-in-ash.
- Lower risk of the formation of dioxins (and precursors), due to a more stable process in the combustion chamber.

Environmental performance and operational data

High operational experience.

Generally, CO emissions from boilers burning international coals can be kept under 50 mg/Nm³ if the combustion is well controlled. Hydrocarbon emissions in modern power plant boilers are negligible, typically below 5 mg/Nm³.

Table 3.39 presents achieved environmental benefits related to the implementation of advanced process control systems.

Table 3.39: Environmental results of a combustion optimiser (Metso advanced process control solution)

Year	Customer	Country	Fuel	Results
1996	Rovaniemi energy	Finland	Peat	Reduced NO _x and thermal flue-gas losses
1998	SE Kaukopää	Finland	Biofuels	CO levels reduced by 67 %, NO _x emissions down by 18 %, and exit O ₂ reduced by 5 %
1999	SE Anjalankoski	Finland	Bio, RDF	Excess NO CO- limited, NO _x reduced by 30 %
2003	MB Kemi	Finland	Biofuels	Thermal efficiency increase 1 percentage point; NO _x emissions down by 30 %
2004	SE Kemi	Finland	Biofuels	Reduced NO _x , CO and thermal flue-gas losses
2005	E.ON Kemsley	UK	Refuse sludge	Waste incineration increased by 10 %
2007	Toppila I	Finland	Peat	Increased stability with low-quality fuels
2008	Billerud Karlsborg	Sweden	Biofuels	Reductions of NO _x , CO ₂ and flue-gas O ₂
2009	Dalkia Factice	France	Biofuels	

Source: [32, Airikka 2012]

Cross-media effects

None.

Technical considerations relevant to applicability

The applicability to old combustion plants may be constrained by the need to retrofit the combustion and/or control command system(s).

Economics

Plant-specific.

Driving force for implementation

No information provided.

Example plant

See Table 3.39.

Komati coal-fired power plant in South Africa and Irsching CCGT (Plant 136).

Coal fired-plants co-incinerating waste (Plants 121 and 142).

Reference literature

[3, LCP TWG 2012] [32, Airikka 2012] [23, Finland 2012]

3.2.3.9 Heat accumulation (heat storage) in CHP or heat-only mode**Description**

Heat accumulation storage in CHP mode.

It is also possible to use it only in boilers.

Achieved environmental benefit

- Reduced emissions.
- For heat-only boilers, the use of peak load gas oil or HFO boilers may be avoided as well.

Environmental performance and operational data

No information provided.

Cross-media effects

No information provided.

Applicability consideration

Applicable to new and existing plants. The applicability may be limited in the case of low heat demand.

Economics

No information provided.

Driving force for implementation

The accumulator allows heat-only boilers (e.g. gas-oil-, HFO-, biomass-fired boilers) and CHP plants (e.g. biomass-fired boilers) to keep emission levels low even with varying load demand.

Example plant

Plants in Sweden and Finland.

Reference literature

No information provided.

3.2.3.10 Integrated gasification combined cycle (IGCC)

See Chapter 4.

3.2.3.11 Combined-cycle combustion

Description

Combination of two or more thermodynamic cycles, e.g. a Brayton cycle (gas turbine/combustion engine) with a Rankine cycle (steam turbine/boiler), to convert heat loss from the flue-gas of the first cycle to useful energy by subsequent cycle(s).

Technical description

The gas turbine or engine exhaust gas typically has a temperature of 430–630 °C, depending on the turbine/engine type and on ambient conditions. This hot gas is led to a heat recovery steam generator (HRSG), where it is used to generate steam, which then expands at a steam turbine power plant, in principle, similar to a condensing power plant.

In today's combined-cycle gas turbines (CCGTs), approximately two thirds of the output comes from the gas turbine and the remaining third from the steam turbine.

The fuel generally used is natural gas or gas oil, but the use of coal in a gasification plant, which will need to be installed upstream of the gas turbine, is also possible (see Chapter 4). A schematic drawing of the combined cycle without supplementary firing (HRSG) technology is given in Figure 3.56.

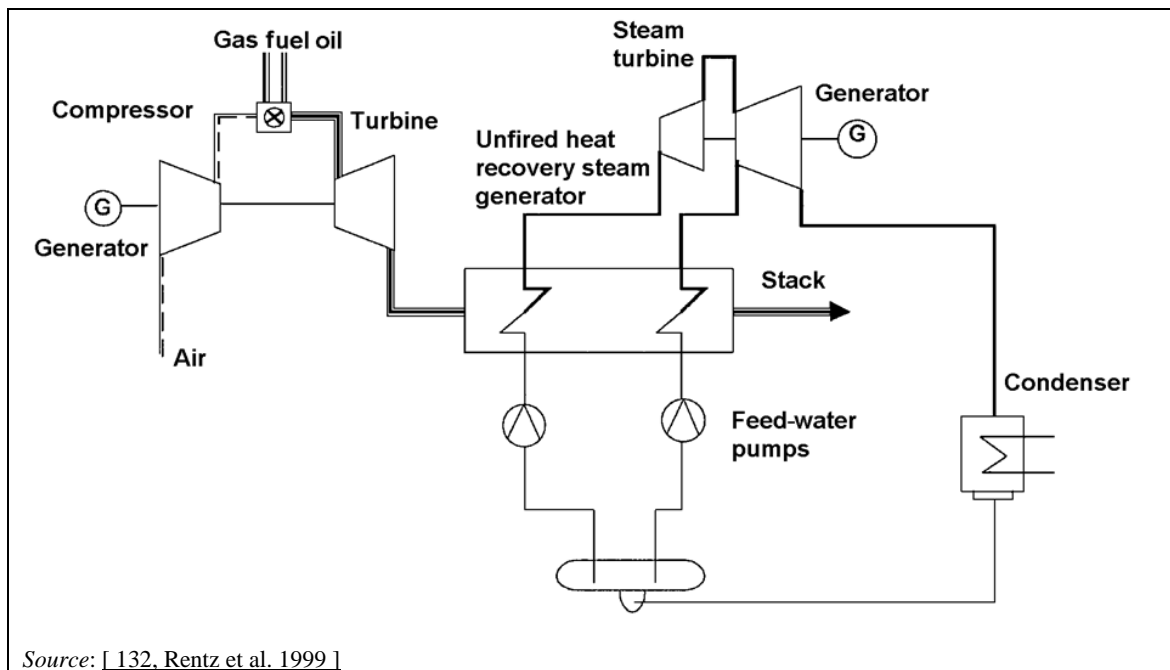

Source: [132, Rentz et al. 1999]

Figure 3.56: Schematic of a combined-cycle power plant with a heat recovery steam generator (HRSG)

A multi-shaft configuration is applied, mostly in phased installations in which the gas turbines are installed and operated prior to the steam cycle operation and where the intention is to operate the gas turbines independently of the steam system. Multi-shaft combined-cycle systems have one or more gas turbine generators and HRSGs that supply steam through a common header to a separate single steam turbine generator unit.

Exhaust gas bypass systems, which are applied in multi-shaft combined-cycle systems to provide fast start-up and shutdown and flexibility of operation, are not required with single-shaft systems or with multi-shaft systems with one gas turbine and one steam turbine.

HRSGs are generally heat exchangers of the convection type, provided with fin tubes, and which exchange the heat from the exhaust gases to the water steam cycle. The exhaust gases are cooled down as much as possible to achieve the highest efficiency. The temperature is restricted due to the risk of corrosion caused by the possible condensation of the acid (sulphur) products from the exhaust gases. Exhaust temperatures of 100 °C are considered normal when combusting natural gas.

HRSGs are constructed in horizontal and vertical configurations. The choice depends on the space requirements and/or the client preferences. Both types are widely used.

Because both natural gas and gas oil are very clean fuels and allow almost complete combustion in gas turbine combustors, there are no problems with ash, char or SO₂ at CCGT plants. The only problem is NO_x, which, at modern plants, is controlled by using special low-NO_x burners and sometimes SCR added to the HRSG. In older burners, the NO_x can be controlled by water or steam sprays into the burners, but this is at the expense of the plant heat rate.

Because less than a third of the oxygen in the gas turbine inlet air is consumed for combustion in the gas turbine combustor, supplementary firing of fuel in the gas turbine exhaust gas is possible. Stationary engines can also apply supplementary firing. In modern CCGTs, this causes a slight increase in the power generation heat rate. However, in industrial cogeneration, it is frequently used as a means of controlling the HRSG's steam generation independently of the gas turbine output. In cogeneration applications, supplementary firing also improves the overall efficiency of heat and power generation.

Achieved environmental benefits

Increased thermal efficiency.

Environmental performance and operational data

At combined-cycle power plants, gas turbines generate power at an efficiency of approximately 33–38 %. In the past 20 years, the heat rate of a CCGT plant has decreased from 2.2 to 1.7, i.e. the LHV efficiency has grown from 45 % to 60 %. Gas turbines are currently still undergoing rapid development, and a CCGT heat rate below 1.61 (efficiency over 62 %) should be possible in the near future. However, commissioning experiences suggest that there are difficulties in achieving the very high efficiencies forecast.

Cross-media effects

No information provided.

Applicability consideration

Generally applicable.

Economics

The great attractions of a CCGT plant are its low heat rate and its low investment cost, which have made CCGTs competitive, despite the high cost of the natural gas fuel.

Driving force for implementation

No information provided.

Example plants

See Chapter 7.

Reference literature

No information provided.

3.2.3.12 Topping cycle

Description

In a topping cycle, the hot flue-gas from the gas turbine is used as combustion air in a conventional power plant with coal- or gas-fired steam boilers. Several options for integrating this cycle with a conventional power plant process are possible.

Technical description

Although this integration is feasible in new designs, topping cycles have typically been applied in the past as repowering options to improve the efficiency of existing plants and/or to increase the heat supply capability of cogeneration plants. The idea of combined cycles for repowering coal-fired plants has grown out of the need to improve the simple ‘Brayton’ (Joule) cycle efficiency by utilising the waste heat in the turbine exhaust gas. This is a natural solution because the gas turbine is a relatively high-temperature machine and the boiler steam turbine a relatively low-temperature machine. In the context of existing coal-fired combustion plants, combined-cycle combustion is normally known as repowering.

The main objectives for repowering are to [82, Ciemat, 2000]:

- increase the power output;
- enhance the performance;
- improve the use of installed plants;
- obtain a greater operating flexibility;
- increase the reliability and availability;

- reduce the operating and maintenance costs;
- extend the plant lifetime;
- reduce emissions and the volume of residues.

A schematic drawing of this technology is shown in Figure 3.57.

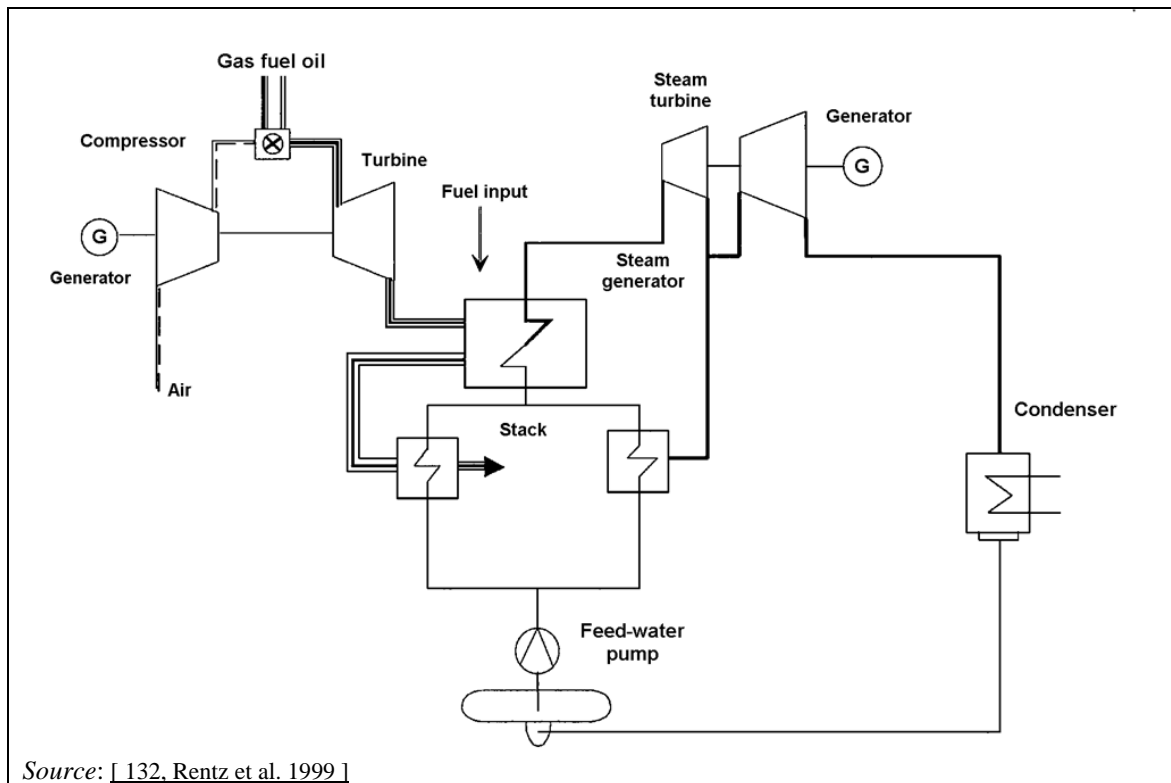

Figure 3.57: Schematic of a topping cycle in a power plant

In a topping cycle, the air preheaters that previously heated the inlet air are not needed and should be removed. A gas turbine is usually selected with approximately the same exhaust gas flow as the design combustion airflow of the boiler. Because of the lower oxygen content of the exhaust gases of the gas turbine (in comparison to normal combustion air), less fuel can be combusted in the existing boiler. This results in a lower average temperature of the boiler and consequently a lower steam production in the boiler. The temperature of the flue-gas at the outlet of the radiation part of the boiler will be about the same as in the existing situation. This results in excess heat at lower temperatures. To use this excess heat, a high-pressure and a low-pressure economiser have to be installed in the boiler. In these economisers (parallel to the existing feed-water preheaters), part of the feed water will be preheated and, therefore, the amount of extraction steam from the steam turbine will decrease. The electrical capacity of the gas turbine is 20–25 % of the total capacity of the power plant.

Topping cycle with feed-water heating

This process configuration is a combination of the two combined cycles mentioned above. Here, part of the condensate and of the feed water is preheated in the heat recovery steam generator. The gas turbine or reciprocating engine HRSG is linked to the steam turbine/steam generator but only on the water/steam side; replacement of the combustion air by the gas turbine or reciprocating engine exhaust gas does not, therefore, take place. Reciprocating engines are suited for low-pressure feed-water preheating.

By using feed-water heating, the prime mover (gas turbine or reciprocating engine) exhaust gases are cooled in the heat exchangers by preheating the feed water. In general, two heat exchangers, (or strings) one each for low-pressure and high-pressure feed-water heating, are installed. The heat exchangers are equipped parallel to the existing (steam-fed) feed-water preheaters.

Heat extractions from the prime mover can be eliminated or reduced, which thus results in an increase in the electrical power output of the prime mover. This implies that the heat in the exhaust gases of the prime mover contributes fully to the electrical power output and efficiency of the unit. It appears that the best solution with feed-water heating will be obtained with a prime mover with a high efficiency and enough heat capacity to achieve the complete feed-water heating of the bottoming cycle.

The increase in power production is, however, limited by the flow capacity of the steam turbine and by the power rating of the generator.

A comparison of the capacity of the preheating system of the unit with the heat available in the gas turbine exhaust gases determines the number of prime movers required and the ultimate increase in heat capacity.

The increased flexibility (electrical power versus thermal heat production) is an important advantage gained by the modifications described. The steam plant can operate independently of the prime mover. The flexibility, however, is limited by the maximum allowable flow through the low-pressure steam turbine.

Achieved environmental benefits

Increased thermal efficiency.

Environmental performance and operational data

Various types of topping cycle gas turbines are in use in applications with outputs of up to 765 MW_e (1 600 MW_{th}), and can achieve efficiencies of up to 48 %. A two-stage combustion process can also be created by using exhaust gases from the gas turbine in the existing boiler, resulting in a considerable reduction of NO_x emissions. In one case, a reduction of NO_x emissions of 50 % has been achieved in the Netherlands.

The efficiency improvement with the feed-water heating option is about 2–5 %, dependent on the prime mover and the existing steam turbine capacity. Because a topping cycle with feed-water heating does not affect the combustion process of the boiler, the boiler emissions are also unaffected. Total emissions are influenced by the contribution of the prime mover exhaust gases.

Cross-media effects

No information provided.

Technical considerations relevant to applicability

Applicable to boilers.

Economics

No information provided.

Driving force for implementation

No information provided.

Example plants

No information provided.

Reference literature

No information provided.

3.2.3.13 Steam turbine and other component upgrades

Description

Upgrade of the steam turbine (ST) and/or of other plant components to increase the energy efficiency.

Technical description

In general, the following measures enable the energy efficiency to be increased:

- operating at the highest possible pressure and temperature of medium-pressure steam, including repeated superheating of the steam to increase net electrical efficiency;
- operating at the highest possible pressure drop in the low-pressure end of the steam turbine through the lowest possible temperature of the cooling water (fresh water cooling);
- adding an additional low-pressure turbine;
- improving the blade geometry of the turbines, e.g. by changing turbine blades to three-dimensional blades during regular maintenance intervals.

An additional low-pressure steam turbine (two-shaft design) increases the turbine outlet area of the existing turbo-generating set. By this measure, it is possible to decrease the uninfluenced steam turbine outlet losses. The steam for the additional low-pressure turbine is fed by the main turbine. Up to a load of about 50 %, the existing outlet area is sufficient and is optimal for the process (the operation with an additional low-pressure turbine would decrease the efficiency in this case). But for an operation with a load of more than 50 %, the additional turbine is used. Using this special operation mode, it is possible to optimise the turbine outlet losses.

Achieved environmental benefit

Increased energy efficiency.

Environmental performance and operational data

An additional low-pressure ST, in full load operation, increases the output power by up to 5 percentage points (with constant fuel flow), by decreasing the steam turbine outlet losses. Replacing the blades of the steam turbine can lead to an increase of electrical efficiency of about 1 percentage point (see Plant 138V).

The impact of other component upgrades on energy efficiency is given in Table 3.40.

Table 3.40: Impact on plant efficiency of component refurbishments and upgrades

Measure	Efficiency improvement	Comments
Replacement/upgrade of burners	Up to 4–5 percentage points	Site-specific considerations (ability to retrofit)
Improvement of economiser	A 40 °F increase in flue-gas temperature equals a ~1 percentage point efficiency loss	
Improvement of air preheater	A 300 °F decrease in gas temperature represents an improvement of about 6 percentage points	
Combustion optimisation	0.5–3.0 percentage points	Neural network based
Instrumentation and controls	0.5–3.0 percentage points (in addition to optimisation)	
Reduction of slagging and fouling of heat transfer surfaces	1–3 percentage points	Site-specific; fuel quality and operating conditions have large impact
Reduction of air leakages	1.5–3.0 percentage points	Requires routine maintenance procedures
<i>Sources:</i> [53, UNEP 2010] [214, EEB 2013]		

Cross-media effects

No information provided.

Technical considerations relevant to applicability

Turbine blade upgrade is generally applicable to existing plants.

Addition of a low-pressure ST is applicable for steam turbines with very high exhaust losses; sufficient space is required.

A key condition is the cooling available and the resulting condenser vacuum at the steam turbine exhaust.

The applicability may be restricted by demand / steam conditions and/or limited plant lifetime.

Economics

No information provided.

Driving force for implementation

No information provided.

Example plant

Plant 138V (blade change).

Plant 131V (addition of low-pressure ST).

Plant 168 (ST upgrade).

Reference literature

No information provided.

3.2.3.14 (Ultra-) Supercritical steam parameters

Description

Operating with supercritical (SC) and ultra-supercritical (USC) steam parameters provides the highest efficiency (which leads to the lowest possible fuel consumption and fuel costs, and lowest overall emissions), by minimising energy fuel costs. SC steam parameters are: pressure above 220.6 bar and temperature above 374 °C. USC steam parameters are not clearly defined. The following levels are often used as a reference: pressure above 250–300 bar, and temperature above 580–600 °C.

Technical description

Increasing steam parameters (SC steam) is another means to increase efficiency when CHP mode is not possible. The technology includes a system for pulverising solid fuel to dust, and a feeding system for combustion in low-NO_x burners with a tangential or wall-firing arrangement in a water-cooled furnace. The traditional fuel used is coal, which can be combined with NG, HFO/gas oil or biomass.

A pressure of ~180 bar and superheated/reheated temperature of 540/565 °C, represent the design limits in natural circulation drum-type boilers for steam pressure and temperature. At these limits, the unit electrical efficiency can reach approximately 42 % (on an LHV basis). Steam double reheating has been introduced in order to increase the efficiency. To further increase the efficiency, SC steam conditions are required.

The 'critical point' of a substance is a well-defined thermodynamic parameter. For water, SC conditions are obtained at the point where water is converted to steam without boiling and with no latent heat addition.

Boilers have been supplied with sizes between 400 MW_e and 1 100 MW_e.

Further development of the technology is ensured due to the continued development of new high-temperature-resistant materials.

Achieved environmental benefits

- Increased thermal efficiency.
- Waste: compared to an SC or subcritical boiler, no new types of waste are generated, but the higher efficiency results in a lower consumption of fuel and a lower production of resulting by-products such as CO₂ (flue-gas), FGD gypsum, NO_x, slag, and ashes.

Environmental performance and operational data

By applying (ultra-) supercritical steam parameters to improve the efficiency, such as a double reheat, and the most advanced high-temperature materials, coal- and/or lignite-fired condensing power plants with a designed energy efficiency of 48 % have been built using direct water cooling.

The heat rate and the efficiency level for recent coal- or lignite-fired condensing power plants (pulverised coal or lignite combustion in DBB or WBB) with direct water cooling (with a capacity of over 300 MW_{th}) is between 2.3 and 2.2 (43 % and 47 %), using supercritical steam parameters.

The highest efficiencies are achieved with the extremely high steam parameters used in baseload plants. Peak load plants with frequent start-up cycles have to be designed with lower steam parameters, resulting in lower efficiencies.

The use of a double reheat cycle increases the net electrical efficiency by about 0.8 percentage points.

The achievable improvement in efficiency is around 1 % (relative) for each 20 °C rise in the reheat temperature and 0.2 % (relative) for a 10 bar pressure increase.

Moving from subcritical to supercritical steam parameters will induce an increase in net cycle efficiency from 38 % to 45–47 %, equivalent to a reduction in coal consumption of 16 % to produce a unit of electricity. For a dedicated biomass application, a slightly lower efficiency will be achieved, due to the restriction in steam data and other technical constraints.

The world's most efficient coal-fired unit (Nordjyllandsværket) has been in operation since 1998 with a documented net efficiency of 47 %, and an availability exceeding 98 %.

It is expected that, with the technology and materials currently available, up to 49 % efficiency is achievable under the right circumstances.

Cross-media effects

An USC boiler compared to a SC or subcritical boiler presents no significant issues. The technology and designs are well proven today, at least up to 305 bar and 610 °C.

Technical considerations relevant for applicability

- Applicable to new units of ≥ 600 MW_{th} operated $> 4\,000$ h/yr.
- Not applicable when the purpose of the unit is to produce low steam temperatures and/or pressures in process industries.
- Not applicable to gas turbines and engines generating steam in CHP mode.
- For units combusting biomass, the applicability may be constrained by high-temperature corrosion in the case of certain biomasses.

Economics

In the event that the steam turbine sets are not adapted, a substantial increase of the investment costs for the steam turbine is expected and therefore the retrofit with a double reheat cycle will not necessarily be profitable at every site.

The technology is mainly competitive for larger thermal power plant units, typically boilers with steam production greater than 1 000 t/h corresponding to approximately 350 MW_e.

As USC boilers are for plants with larger output power requirements, coal is typically the most cost-efficient primary fuel option.

Driving force for implementation

Efficiency and costs are generally the main drivers for investing in (ultra-) supercritical technology.

Environment / Political / Clean coal technology: a substantial part of the world's growth in power generation is expected to be based on coal for at least the next 20–30 years. At the same time, there is a requirement for the reduction of harmful emissions from coal-fired units and also an increasing demand to limit greenhouse gas (CO₂) emissions. The current approach for addressing these requirements is called 'Clean Coal Technology'. The ultra-supercritical (USC) power cycle is one of the most favoured solutions.

Example plants

Plant 27 (Avedøre 2, DK).

Plant 34 (Nordjyllandsværket, DK).

Plant 253 (Torrevaldaliga, IT).

Plant 116 (Niederaußem, DE).

Since 2011, several projects with superheated steam parameters of 27.2 MPa, 600 °C / 5.5 MPa, 605 °C and an efficiency of > 43 % have been put into operation in Europe: Walsum 10, Boxberg R, Neurath BOA 2 and 3, Ledvice, etc. The first two experienced material problems and had to change the T24 alloy to a more common one, reducing the achievable energy efficiency. The latter two also experienced problems and delays in their commissioning but were built using the T24 alloy. [215, CZ 2013] [216, E&P 2013]

Reference literature

[3, LCP TWG 2012] [217, Poulsen 2005] [218, Bendixen 2003] [219, IEA 2008] [220, IEA 2010] [221, Kaplan 2008] [222, World Bank 2008].

3.2.3.15 Flue-gas condenser

Description

The flue-gas condenser is a heat exchanger where the return flow of district heating water is preheated by the flue-gases before it is heated in the steam condensers. The vapour content in the flue-gases thus condenses as it is cooled by the district heating water. A flue-gas condenser is used both to increase the energy efficiency of the combustion unit and to clean the flue-gas.

Technical description

The warm (e.g. 180 °C) wet flue-gas is cooled down (e.g. by the return water from the district heating system). The flue-gas temperature drops to 55 °C, and at the same time water is condensed from the flue-gases. On the other side (district heating side) of the flue-gas condenser, the return water from district heating is heated up to approximately 60 °C.

Approximately 20 % extra energy can be obtained from the flue-gas condenser (depending on the moisture in the fuel), without increased fuel consumption. At the same time, the flue-gas is cleaned of dust and other pollutants, such as acid gases.

The effectiveness of the flue-gas condenser is mainly dependent on the moisture content of the fuel and on the temperature of the district heating water. Normally with a 90 MW boiler, the condenser could provide up to 25–30 MW of heat energy at full load. However, the effect can be reduced by bypassing the district heating water past the condenser, which is normally done during summer when the district heating load goes below the minimum load for the boiler. This action may also be called for during periods when the boiler operates above minimum load (but below maximum load), e.g. when there is a preference for electricity production, as the electricity production is otherwise limited by the district heating load (no other cooling available).

Achieved environmental benefits

- Increased overall energy efficiency.
- Reduced specific fuel consumption.
- Reduced dust, particulate-bound metals and SO_x emissions.

Environmental performance and operational data

No information provided.

Cross-media effects

No information provided.

Technical considerations relevant to applicability

The technique is applicable to plants where there is a possibility of using large quantities of low-temperature (< 60–65 °C) heat.

When the technique involves condensing the flue-gas below its dew point, it requires the use of appropriate materials like corrosion-resistant stainless steel.

Economics

No information provided.

Driving force for implementation

No information provided.

Example plants

Plants 453, 454, 455, 456, 470, 472 and 473.

Reference literature

[223, Cortina 2006]

3.2.3.16 Cooling tower air emission discharge**Description**

Air emission release through the cooling tower and not a dedicated stack.

Technical description

The purified flue-gas is discharged downstream of the flue-gas desulphurisation system via the cooling tower. In this process, the clean gas is delivered to the cooling tower via a fibreglass-reinforced duct above the distribution level and mixed completely with the cooling water cloud in such a way that contact with the walls of the cooling tower is avoided. In recent plants, the tower walls are made of acid-resistant concrete. In the interior of the cooling tower, the flue-gas is distributed either via a distribution piece or a shutter system across the cooling tower cross section.

Achieved environmental benefits

- Increased thermal efficiency: reheating of the flue-gas after the FGD plant is not necessary.
- No stack is needed.

Environmental performance and operational data

No information provided.

Cross-media effects

Potential for emission of liquid pollutants, especially acid aerosols.

Technical considerations relevant for applicability

Only applicable to units fitted with wet FGD where reheating of the flue-gas is necessary before release, and where the unit cooling system is a cooling tower.

Economics

No information provided.

Driving force for implementation

No information provided.

Example plants

Plants 116V, 23, 130 (retrofit).

Reference literature

[276, Matthee 2014]

3.2.3.17 Wet stack

Description

Design of the stack to enable water vapour condensation from the saturated flue-gas, and thus avoid the need to use a gas-gas heater after the wet FGD.

Technical description

Many plants with wet FGD systems use reheated flue-gas to dry the saturated gases exiting the wet FGD before they are sent to the stack.

New plants no longer use flue-gas reheating; this is also being removed from existing plants to improve energy efficiency and when changing WFGD systems.

In the wet stack system, the water content of the flue-gas condenses on the walls of the absorber outlet ducting and stack liner. This formed liquid is collected and drained. Condensates are treated together with the FGD waste water, and the wet stack should be properly designed in order to avoid the release from the stack of uncondensed liquid droplets.

Achieved environmental benefits

- Increased thermal efficiency.
- Prevention of potential emissions to air of SO₂ and other pollutants such as Hg, due to the leakage that can exist in the rotating heat exchanger after the wet FGD.

Environmental performance and operational data

No information provided.

Cross-media effects

- Visible plume.
- Stack liquid discharge (SLD) phenomenon, whereby entrained droplets in the flue-gas are deposited near the plant before evaporating.

Technical considerations relevant for applicability

Applicable to boilers. Generally applicable to new and existing plants fitted with wet FGD.

Economics

Condensates drained from the stack need to be neutralised.

Driving force for implementation

No information provided.

Example plants

Plants 122aV and 122bV.

Reference literature

[224, EPRI 2012]

3.2.3.18 Fuel preheating/drying**Description**

Fuels are preheated or dried before entering the combustion chamber, often by recovering the flue-gas energy content.

Technical description

With steam or flue-gas, low value heat can be recovered from power processes to increase the fuel energy (e.g. by recovering the heat from the flue-gas). Many alternative technologies are commercially available and new technical alternatives are under development (e.g. lignite pre-drying with low-pressure superheated steam via heat exchanger, see Section 11.4.1.1).

Achieved environmental benefits

Increased thermal efficiency.

Environmental performance and operational data

No information provided.

Cross-media effects

Additional emissions to water and air are possible, depending on the configuration.

Drying/pressing of fuel requires additional auxiliary power, to be weighed against the expected improvement in thermal efficiency.

Technical considerations relevant to applicability

Generally applicable to new gas-fired plants. The applicability may be limited for existing gas-fired plants due to operation and maintenance constraints in the gas specification.

Drying is applicable to biomass, peat and lignite within the constraints associated with spontaneous combustion risks (e.g. the moisture content of peat is kept above 40 % throughout the delivery chain). Press drying is applied to bark fuel.

The retrofit of existing plants may be restricted by the extra calorific value that can be obtained from the drying operation (e.g. some pelletised biomass) and by the limited retrofit possibilities offered by some boiler designs or plant configurations.

Economics

The investment cost and energy consumption of fuel dewatering equipment are generally prohibitive except for very wet fuels.

Driving force for implementation

No information provided.

Example plants

Plant 191: a fuel gas efficiency preheater heats fuel gas to 150 °C via IP economiser feed-water extraction.

Plant 116: prototype drying plant for lignite (WTA technique), offering potential for an efficiency increase in the range of 4–6 percentage points for Rhenish lignite.

Rauma BFB boiler (FI): the combustion plant includes a fuel drying plant, where the bark and sludge available from the neighbouring mill are dried, reducing the moisture from 55–60 % to 40–45 %. The drying is performed using the heat recovered from paper mill waste waters (55–65 °C). The drying lasts about one hour on a 120 m long conveyor belt and at a temperature between 55 °C and 65 °C.

Reference literature

No information provided.

3.2.3.19 Cooling system

For the different cooling system techniques, see the Industrial Cooling Systems (ICS) BREF.

3.2.4 Techniques to prevent and/or reduce emissions to water

In order to decide which are the best waste water management and treatment practices for a specific LCP, a thorough assessment of the expected waste water streams is carried out. The waste water is characterised regarding the nature and concentrations of the pollutants and the pattern of the expected flows from the various sources. Waste water streams that are typically segregated include surface water run-off, cooling water, and waste water from flue-gas treatment. Then a decision is taken as to the configuration of the most appropriate waste water treatment plant for each specific case. Figure 3.6 and Figure 3.7 show examples of waste water from flue-gas treatment systems.

The removal of polluting substances from the waste water prior to discharge to the environment is effected by the application of the appropriate combination of a wide range of physical, chemical and biochemical processes, including:

- filtration;
- pH correction/neutralisation;
- coagulation/flocculation/precipitation;
- sedimentation/filtration/flotation;
- dissolved hydrocarbon treatment;
- oil-water separation systems;
- biological treatment.

The selection of the appropriate treatment and/or management technique depends on the main quality characteristics and volume of the waste water and the quality standards required by the receiving waters of the treated effluents.

Thus, effluents containing high amounts of suspended solids, present in LCPs burning solid fuels, are normally subjected to a primary settling stage for the removal of heavier suspended solids. This is followed by flocculation, with coagulant and organic polymer dosing aided by pH adjustment, before final settling and removal of the sludge. A final pH adjustment of the treated effluent may be required before discharge to the receiving water.

Acid or alkali effluents (e.g. ion exchangers' regeneration effluents, boiler cleaning chemicals, boiler blowdown) need to be neutralised before discharge.

Oily effluents arising from the fuel oil treatment systems, leakage or dewatering of fuel oil storage facilities, unloading stations, transformer area, etc., may contain high amounts of oil. Therefore, a primary oil separation stage is needed for the collection of these oils, normally carried out in gravity separation tanks equipped with oil retention baffles.

The residual waste waters, which may still contain small amounts of oil in oil-water emulsion form, are treated in API or lamella separators equipped with oil skimmers or using air flotation. Sanitary waste water may be treated in a municipal sewerage system, if one is available. Otherwise, it may be either discharged to a septic tank or treated in an on-site biological unit, normally of the extended aeration activated sludge type.

In certain cases, instead of being treated in the LCP waste water treatment plant along with other effluents, special waste waters (e.g. water containing hydrocarbons used for analysis in the laboratory) are collected separately and disposed of off site by an authorised contractor. The management of firefighting water, which occurs only in emergency situations, depends on the location of the fire. Such waters are collected by the drainage systems corresponding to the fire location, retained in firewater retention ponds and treated, if necessary, before discharge. Effluents from LCPs may be treated either separately by stream, or using combined treatment techniques. Examples are given below.

The issue of water and waste water management is important within an LCP. By optimising the recycling of the various intermediate discharges in the plant, a significant reduction in overall water consumption can be achieved, as well as minimising the final liquid effluent quantities that require further treatment. For example, in several cases it is possible to collect all waste water from the various discharge points of the FGD plant and to reintroduce them into the process (scrubber).

In addition, various waste water streams may be used for fly ash humidification instead of service or raw water. Clean waste water downstream of the waste water treatment plant is usually collected in retention ponds to supply water to points of consumption where the water quality is adequate to the demand, e.g. limestone slurry preparation for FGD or for FGD gypsum and fly ash mixture stabilisation prior to disposal in a landfill. However, it is not possible to create a waste-water-free FGD system only by direct recirculation and circuitry in the FGD system. If the chloride value increases, it is necessary to elutriate. The reduction of the waste water and of the withdrawal rate is possible by recycling other streams like rainwater, cooling water, etc. The alternative, evaporating this waste water, may require considerable additional energy and waste disposal may offset the environmental benefits.

[1, Eurelectric 2012]

Another technique to reduce water usage and the volume of contaminated waste water discharged is the handling of bottom ash from the boilers. Dry bottom ash handling is described in Section 3.2.5.2.

3.2.4.1 Filtration

Description

Filtration is the separation of solids from waste water effluents passing through a porous medium. It includes different types of techniques, e.g. sand filtration, microfiltration and ultrafiltration. It is generally used in addition to coagulation and sedimentation or precipitation softening for the removal of solids from surface water or waste water. Filtration does not remove dissolved solids. Filters typically require a cleaning operation – backwashing – with a reverse flow of fresh water.

Technical description

Commonly used filter systems include:

- granular-medium filter, or sand filter, which is widely used as a waste water treatment device (the medium of sand filters need not be literally sand), mainly used for waters with a low solids content;
- gravity drum filter, used for sewage treatment and removal of activated sludge flocs; its efficiency is dependent on the screen fabric;
- rotary vacuum filter, well-suited to precoat filtration, which is used for oily sludge dewatering and slop de-emulsification;
- membrane filter;
- belt filter press, which is largely used for sludge dewatering, but also for liquid-solid separation operations;
- filter press, which is usually used for sludge dewatering, but also for liquid-solid operations, suitable for a high solids content.

Achieved environmental benefits

Reduction of suspended solids and metals in the waste water discharge.

Environmental performance and operational data

See the CWW BREF.

Cross-media effects

No information provided.

Technical considerations relevant to applicability

Generally applicable.

Economics

No information provided.

Driving force for implementation

No information provided.

Example plants

Plants 455 and 476.

Reference literature

CWW BREF.

Robinson, J. 2000. Water, Industrial Water Treatment. Kirk-Othmer Encyclopaedia of Chemical Technology.

3.2.4.2 Coagulation, flocculation, sedimentation and precipitation

Description

Coagulation and flocculation are used to separate suspended solids from waste water and are often carried out in successive steps. Coagulation is carried out by adding coagulants with charges opposite to those of the suspended solids. Flocculation is carried out by adding polymers, so that collisions of microfloc particles cause them to bond thereby producing larger flocs.

Sedimentation is the separation of suspended solids by gravitational settling.

Precipitation is the conversion of dissolved pollutants into insoluble compounds by adding chemical precipitants. The solid precipitates formed are subsequently separated by sedimentation, flotation or filtration. If necessary, this may be followed by microfiltration or ultrafiltration. Typical chemicals used for metal precipitation are lime, dolomite, sodium hydroxide, sodium carbonate, sodium sulphide and organosulphides. Calcium salts (other than lime) are used to precipitate sulphate or fluoride.

Technical description

When the particles cannot be separated by simple gravitational means, e.g. when they are too small, their density is too close to that of water, or when they form colloids, special chemicals are added to cause the solids to settle, e.g.:

- aluminium sulphate (alum);
- ferric sulphate;
- ferric chloride;
- lime;
- polyaluminium chloride;
- polyaluminium sulphate;
- cationic organic polyelectrolytes;
- non-ionic polyelectrolytes;
- anionic polyelectrolytes;
- (organo)sulphides.

These chemicals cause the destabilisation of colloidal and small suspended particles (e.g. clay, silica, iron, heavy metals, dyes, organic solids, oil in waste water) and emulsions entrapping solids (coagulation) and/or the agglomeration of these particles to flocs large enough to settle (flocculation). In the case of flocculation, anionic and non-ionic polymers are also used. A controlled pH range is essential to avoid poor clarification performance.

Achieved environmental benefits

- Removal of fluoride, sulphate, metal, TOC and particulates.
- Reduced waste water discharge from non-settleable material and metals.

Environmental performance and operational data

See the CWW BREF.

Cross-media effects

Sludge production. Sludge can be added to coal internally and in some cases sludge (e.g. from decarbonisation) could be added in the FGD, or as a filling material in the mining industry.

Technical considerations relevant to applicability

Generally applicable.

Economics

No information provided.

Driving force for implementation

No information provided.

Example plants

Plants 662 and 464.

Reference literature

CWW BREF.

Robinson, J. 2000. Water, Industrial Water Treatment. Kirk-Othmer Encyclopaedia of Chemical Technology.

3.2.4.3 Flotation

Description

Flotation is a process whereby solid or liquid particles or particulates are separated from the waste water phase by attaching to air bubbles. The buoyant particles accumulate at the water surface and are collected with skimmers.

Technical description

There are three methods of flotation, distinguished by the way air is added:

- vacuum flotation, where air is dissolved at atmospheric pressure, followed by a pressure drop to allow the formation of bubbles;
- induced air flotation (IAF), where fine bubbles are drawn into the waste water via an induction device such as a venturi or orifice plate;
- dissolved air flotation (DAF), where pressurised air (0.4–0.8 MPa, or 1.0–1.2 MPa for aluminium compounds) is dissolved into the waste water, or a part of the total waste water, and subsequently released to form small bubbles.

Flocculant additives, such as aluminium and ferric salts, activated silica and various organic polymers, are commonly used to support the flotation process. Their function, besides coagulation and flocculation, is to create a surface or a structure able to absorb or entrap the air bubbles.

Achieved environmental benefits

Reduced non-settleable material and free oil from the waste water discharge.

Environmental performance and operational data

See the CWW BREF.

Cross-media effects

Sludge generation.

Technical considerations relevant to applicability

No information provided.

Economics

No information provided.

Driving force for implementation

No information provided.

Example plants

Plant 253.

Reference literature

CWW BREF.

Robinson, J. 2000. Water, Industrial Water Treatment. Kirk-Othmer Encyclopaedia of Chemical Technology.

3.2.4.4 Oil-water separation**Description**

The separation of oil and water and subsequent oil removal can be divided into:

- gravity separation of free oil, using separation equipment;
- emulsion breaking, using emulsion-breaking chemicals, e.g.:
 - polyvalent metal salts such as alum, aluminium trichloride, ferrous chloride, ferrous sulphate;
 - mineral acids such as sulphuric acid, hydrochloric acid, nitric acid;
 - adsorbents such as pulverised clay, lime;
 - organic polymers such as polyamines, polyacrylates;

and subsequent separation of de-emulsified oil by coagulation/flocculation and air flotation.

Technical description

The commonly used oil-water separators are the following:

- **American Petroleum Institute Separator (API)**, is the simplest type, consisting of an open rectangular basin and a flight scraper, which moves the sludge to a collection pit and the oil to the skimming device; able to intercept large slugs of oil.
- **Parallel Plate Interceptor (PPI)**, equipped with plates parallel to the current, which enlarge the active surface area considerably, and an oil skimming device; not suitable for intercepting large slugs.
- **Corrugated Plate Interceptor (CPI)**, equipped with corrugated plate packs placed counter-current and an oil skimming device; not suitable for intercepting large slugs, but with good separation efficiency.

Achieved environmental benefits

Reduced oil and solids from the waste water discharge.

Environmental performance and operational data

See the CWW BREF.

Cross-media effects

No information provided.

Technical considerations relevant for applicability

Generally applicable.

Economics

No information provided.

Driving force for implementation

No information provided.

Example plants

No information provided.

Reference literature

CWW BREF.

Robinson, J. 2000. Water, Industrial Water Treatment. Kirk-Othmer Encyclopaedia of Chemical Technology.

3.2.4.5 Crystallisation

Description

The removal of ionic pollutants from waste water by crystallising them on a seed material such as sand or minerals, working in a fluidised bed process.

Some combustion plants use crystallisation after evaporation.

Technical description

The crystallisation device consists mainly of:

- the cylindrical reactor with bottom influent and top effluent;
- seed material, i.e. pellets of filter sand or minerals, kept in a fluidised bed condition;
- the circulation system with a recirculation pump.

The principle of the circulation system is to mix the influent waste water with the circulation stream with the lower anion or metal concentration. Because of the circulation system the reactor can work more flexibly, e.g.:

- fluctuations in the influent flow and composition are easily eliminated;
- all kinds of waste water with concentrations in the range of 10–100 000 ppm can be treated by simply adapting the circulation ratio (more highly concentrated waste water requires a larger circulation ratio);
- fluidisation of pellets is also maintained if no waste water is fed into the reactor.

Achieved environmental benefits

Reduction of metals and metalloids, sulphate (SO_4^{2-}) and fluoride (F^-) in the waste water discharge.

Environmental performance and operational data

No waste water is discharged.

Cross-media effects

- Energy consumption.
- Residues handling and disposal.

Technical considerations relevant to applicability

Generally applicable.

Economics

No information provided.

Driving force for implementation

No information provided.

Example plants

Plant 211 and Plant 253.

Reference literature

CWW BREF.

Robinson, J. 2000. Water, Industrial Water Treatment. Kirk-Othmer Encyclopaedia of Chemical Technology.

3.2.4.6 Evaporation**Description**

Evaporation of waste water is a distillation process where water is the volatile substance, leaving the concentrate as a bottom residue to be disposed of. The aim of this operation is to reduce the volume of waste water or to concentrate mother liquors. The volatile steam is collected in a condenser and the condensed water is, after subsequent treatment if necessary, recycled.

Technical description

There are many types of evaporators. Their suitability depends on the individual requirements. Examples of evaporators are:

- natural-circulation evaporators, suitable for material that is not sensitive to heat;
- short-tube vertical evaporators, suitable for non-corrosive or non-crystallising liquors;
- basket-type evaporators, same application as short-tube evaporators;
- falling film evaporators, used in the fertiliser industry to concentrate urea, phosphoric acid, ammonium nitrate, etc.;
- agitated thin film evaporators, used for concentrating, fractionating, deodorising and stripping in the production of pharmaceuticals, polymers, organic and inorganic chemicals.

Evaporators are usually operated in series, where the condensation heat of one stage heats the condensate (i.e. waste water) of the preceding stage. Operation under vacuum minimises the energy demand. Normal operation conditions are 12–20 kPa and 50–60 °C.

Achieved environmental benefits

Reduction of the pollutants in the waste water discharge.

Environmental performance and operational data

No waste water is discharged.

Cross-media effects

- Energy consumption.
- Residues handling and disposal.

Technical considerations relevant to applicability

Generally applicable.

Economics

No information provided.

Driving force for implementation

No information provided.

Example plants

Plant 211 and Plant 253.

Reference literature

CWW BREF.

Robinson, J. 2000. Water, Industrial Water Treatment. Kirk-Othmer Encyclopaedia of Chemical Technology.

3.2.4.7 Air stripping

Description

Waste water stripping is an operation in which waste water is brought into contact with a high flow of a gas current in order to transfer volatile pollutants from the water phase to the gas phase. The pollutants are removed from the stripping gas so that it can be recycled into the process and reused. Organic and inorganic volatile substances (e.g. ammonia) are transferred from waste water to waste gas, greatly increasing the surface area of the contaminated water exposed. Water evaporation, however, decreases the temperature of the waste water, thus decreasing the volatility of the contaminants.

Technical description

The most common stripping facilities are:

- packed tower stripper, with:
 - spray nozzles at the top to distribute waste water over the packing, and the stripping gas led counter-current through the packing;
 - a sump at the bottom to collect the decontaminated water, additionally equipped with an air heater (for air stripping);
 - an automated control system and air emission control system (GAC unit, catalytic oxidiser or incinerator);
- stripping tank, in which volatile compounds are stripped by bubbling gas (air, steam) into a waste water ducting tank.

The equipment consists of:

- a buffer tank for waste water;
- a pretreatment tank for pH adjustment;
- stripping column(s), operated counter-flow;
- feed preheater, recovering heat from the subsequent stripping steam condenser;
- condenser, air- or water-cooled;
- downstream facilities for gas treatment.

Strippers can be operated continuously or batchwise, the latter ensuring consistent performance and higher energy efficiency than continuously operated units.

Achieved environmental benefits

Reduced ammonia content in waste water.

Environmental performance and operational data

The ammonia content may be reduced by up to 90 % (Plant 464).

Cross-media effects

If the gases are not returned to the combustion unit, then transfer of ammonia from water to air.

Technical considerations relevant to applicability

Applicable in the case of a high ammonia content in waste water, e.g. due to SCR/SNCR use for air pollution control.

Economics

No information provided.

Driving force for implementation

No information provided.

Example plants

Plant 473 and Plant 464.

Reference literature

CWW BREF.

Robinson, J. 2000. Water, Industrial Water Treatment. Kirk-Othmer Encyclopaedia of Chemical Technology.

3.2.4.8 Ion exchange**Description**

Ion exchange is the removal of undesired or hazardous ionic constituents of waste water and their replacement by more acceptable ions from an ion exchange resin, where they are temporarily retained and afterwards released into a regeneration or backwashing liquid.

Technical description

The equipment of an ion exchanger usually consists of:

- a vertical cylindrical pressure vessel with corrosion-resistant linings that contains the resin, usually as a packed column with several possible configurations;
- a control valve and piping system, directing the flows of waste water and regeneration solution to the proper locations;
- a system to regenerate the resin, consisting of salt-dissolving and dilution control equipment.

An inlet distribution system is located at either the top or the bottom of the vessel and provides an even distribution of the influent waste water, to avoid hollowing out flow channels in the resin bed. It also acts as a collector for backwash water.

Ion exchangers commonly in use are macro-porous granule resins with cationic or anionic functional groups. Some resins need acid and caustic for regeneration. If organics are present, the resins may be subject to fouling. The regenerant streams will need to be neutralised.

Achieved environmental benefits

Reduced metal ions content in waste water.

Environmental performance and operational data

See the CWW BREF.

Cross-media effects

Production of sludge and brine to be treated or disposed of.

Technical considerations relevant to applicability

Generally applicable.

Economics

No information provided.

Driving force for implementation

No information provided.

Example plants

Plant 464 and Plant 473.

Reference literature

CWW BREF.

3.2.4.9 Biological treatment

Description

Biological treatment is the degradation of dissolved organic substances with microorganisms (i.e. bacteria) as oxidising agents.

Technical description

There are basically three types of metabolic processes: aerobic processes (using dissolved oxygen), anoxic processes (using the biological reduction of oxygen donors) and anaerobic processes (without an oxygen supply).

Some plants in the United States operate biological treatment systems to reduce biochemical oxygen demand and some other coal-fired power plants use anoxic/anaerobic biological systems to reduce certain pollutants (e.g. selenium, mercury, nitrates) more effectively than has been possible with sedimentation, chemical precipitation or aerobic biological treatment processes. Plants employing an anoxic/anaerobic biological treatment system operate a fixed-film bioreactor that consists of an activated carbon bed, such as granular activated carbon or some other porous substrate that is inoculated with naturally occurring, beneficial microorganisms that reduce selenium and other metals. [210, USA EPA 2013]

Untreated waste water can contain nitrogen in the form of organic nitrogen, ammonia ($\text{NH}_3\text{-N}$), nitrite ($\text{NO}_2\text{-N}$) and nitrate ($\text{NO}_3\text{-N}$). Biological nitrogen removal involves the initial conversion of the nitrogen contained in the waste water to nitrate and, then, conversion of the $\text{NO}_3\text{-N}$ to inert nitrogen (N_2), which is released from the waste water to the atmosphere. More in detail, biological treatment of waste water for the removal of nitrogen occurs in three steps:

- ammonification (breakdown of organic N to $\text{NH}_3\text{-N}$);
- nitrification (oxidation of $\text{NH}_3\text{-N}$ to $\text{NO}_3\text{-N}$);
- denitrification (conversion of $\text{NO}_3\text{-N}$ to N_2).

Achieved environmental benefits

Reduced organic content, nitrogen and metals in waste water.

Environmental performance and operational data

See Reference Literature below.

Cross-media effects

When the nitrification/denitrification stages are part of the central WWTP, they may contribute to the release of odours and volatile substances.

Technical considerations relevant to applicability

Nitrification may not be applicable in the aerobic biological treatment of ammonium (NH_4^+) in the case of high chloride concentrations (i.e. around 10 g/l). Studies of nitrogen removal from waste water with high salinity (30 g/l) have been reported.

Economics

No information provided.

Driving force for implementation

No information provided.

Example plants

Duke Energy Carolinas' Allen Steam Station (USA).

Belews Creek Steam Station (USA).

Reference literature

[210, USA EPA 2013] [211, Wylie et al. 2008] [212, Ramos, A. F., et al. 2007] [289, COM 2014]

3.2.4.10 Techniques to consider for plants equipped with flue-gas treatment with emissions to water (Wet FGD, FG condenser)

Table 3.41: Techniques for the prevention and control of water pollution from plants operating flue-gas treatment with emissions to water

Technique	Technical description	Achieved environmental benefits	Environmental performance and operational data	Cross-media effects	Technical considerations relevant to applicability	Economics	Example plants
1 Mechanical treatment							
Filtration	Separation of solids from waste water effluents passing through a porous medium	Reduction of oil and solids in the waste water discharge	NA	Sludge production	Generally applicable	Plant-specific	Plants 455, 476
Oil separation	Separation of oil and water by gravity	Reduction of oil in the waste water discharge		Sludge production	Generally applicable	Plant-specific	NA
2 Physico-chemical treatment							
Flocculation, sedimentation, precipitation, neutralisation	Addition of special chemicals to cause solids that cannot be separated by simple gravitational techniques to settle	Removal of fluoride, metals, TOC, suspended solids	NA	Sludge production	Generally applicable	Plant-specific	Plants 662, 464
Softening, crystallisation, evaporation	Crystallisation is closely related to precipitation. In contrast to it, the precipitate is produced on seed material such as sand or minerals	Reduction of the pollutants in the waste water discharge. Avoidance of water discharge		Concentrated waste water or sludge production . Energy consumption.	Applicable to ZLD (zero liquid discharge) system	Plant-specific	Plants 211, 253

Stripping	Waste water is brought into contact with a high flow of a gas current in order to transfer volatile pollutants from the water phase to the gas phase	Reduction of ammonia content in waste water		Transfer of ammonia to air by stripping	Applicable if high ammonia content in waste water because of SCR/SNCR	Plant-specific	Plants 470, 464
Ion exchange	Removal of undesired or hazardous ionic constituents of waste water and their replacement by more acceptable ions from an ion exchange resin	Removal of ions and ionisable species from waste water		Sludge and brine production	Generally applicable	Plant-specific	Plant 464
3 Reduction of waste water							
Reuse of water	Mixing the waste water from WFGD for ash transport, by-products, etc.	Avoidance of water discharge	NA	Stabilised material can be used as filling material in opencast mines	Applicable to plants close to opencast mines	Plant-specific	Plant 170
Water recycling	Return of waste water to the production process	Reduction of water discharge		High salt content in water discharged	Generally applicable. Compulsory for soft water used as make-up water for WFGD	Plant-specific	Plants 547, 137
4 Biological treatment							
Biological treatment	Degradation of dissolved organic substances with microorganisms (i.e. bacteria) as oxidising agents	Reduction of organic content, nitrogen and metals in waste water	EPA-821-R-13-002	It may contribute to the release of odours and volatile substances	Nitrification may not be applicable in the case of high chloride concentrations (i.e. around 10 g/l)	Plant-specific	Duke Energy Carolinas' Allen Steam Station (USA), Belews Creek Steam Station (USA)
NB: NA: No relevant specific information available.							

Environmental performance and operational data

Graphs corresponding to waste water emissions are presented in Figure 3.58 to Figure 3.72. The emissions correspond to the direct discharge to receiving waters of large combustion plants applying wet abatement techniques to treat the flue-gases. These emissions cover only the situations in which the waste water streams arising from the wet abatement techniques used to treat the flue-gases are treated before discharge.

The plants' emissions to water may, in certain cases, include not only the emissions of the named plant but also the emissions of other plants whose data have been submitted in the data

collection or the emissions of other plants that are not part of the data collection. In the first case, the waste water emissions are reported with the plant code indicated in Table 3.42 and the emissions correspond at least to emissions of the named plant and of the associated plants shown in the table.

Table 3.42: Plant emissions included in the plant codes shown in Figure 3.58 to Figure 3.72

Plant code shown in the graphs	Plant emissions included in the plant code
117-1	117-2
122a	122b
124-1	124-2; 134
127-1	127-2
128-1	128-2; 128-3; 128-4; 129-1; 129-2
211	212
26	27
384-1	384-2
386-1	386-2; 386-3; 386-4
415-1	415-2
435-2	435-1
441-2	441-1
478-1	478-2
487-2	487-1; 487-3; 487-4
138	139
456	457
197	198; 199; 200
77	78
130	137
219	221
223	224
470	472
258	259
262	263

The plants of the data collection that discharge the waste water to off-site plants are not included in the graphs (e.g. Plants 26, 24, 77, 470). The effect of downstream waste water treatment plants in the case of indirect discharges is unknown.

A number of plants without discharge of waste water from the abatement techniques for emissions to air are not represented. These are those plants which are reusing or recycling the waste water (e.g. Plants 170, 116) or using ZLD (e.g. Plants 253, 211).

The following graphs represent the average emissions over one year in direct discharges to a receiving water body, where the waste water originates from the combustion plants' flue-gas treatment alone or mixed with other waste water streams from the plant. The plants are marked depending on the specific stream, i.e. only from wet flue-gas desulphurisation, only from the flue-gas condenser or from the flue-gas desulphurisation stream mixed with other streams. The maximum and minimum emissions are also represented in the graphs. The fluctuation of the maximum values around the average depends on the pollutant, but is generally lower than in other industry sectors where biological waste water treatment is used (e.g. the chemical

industry). In the EU, emission limit values for emissions to water are usually expressed as short-term averages, often based on 24-hour composite samples.

TSS emissions

Figure 3.58 shows the yearly total suspended solids (TSS) emissions in direct discharges to a receiving water body, where the waste water originates from the combustion plants' flue-gas treatment alone or mixed with other waste water streams from the plant. A number of plants, including plants treating waste water originating exclusively from flue-gas treatment, achieve maximum TSS emission levels below 30 mg/l while a few achieve maximum emission levels below 10 mg/l.

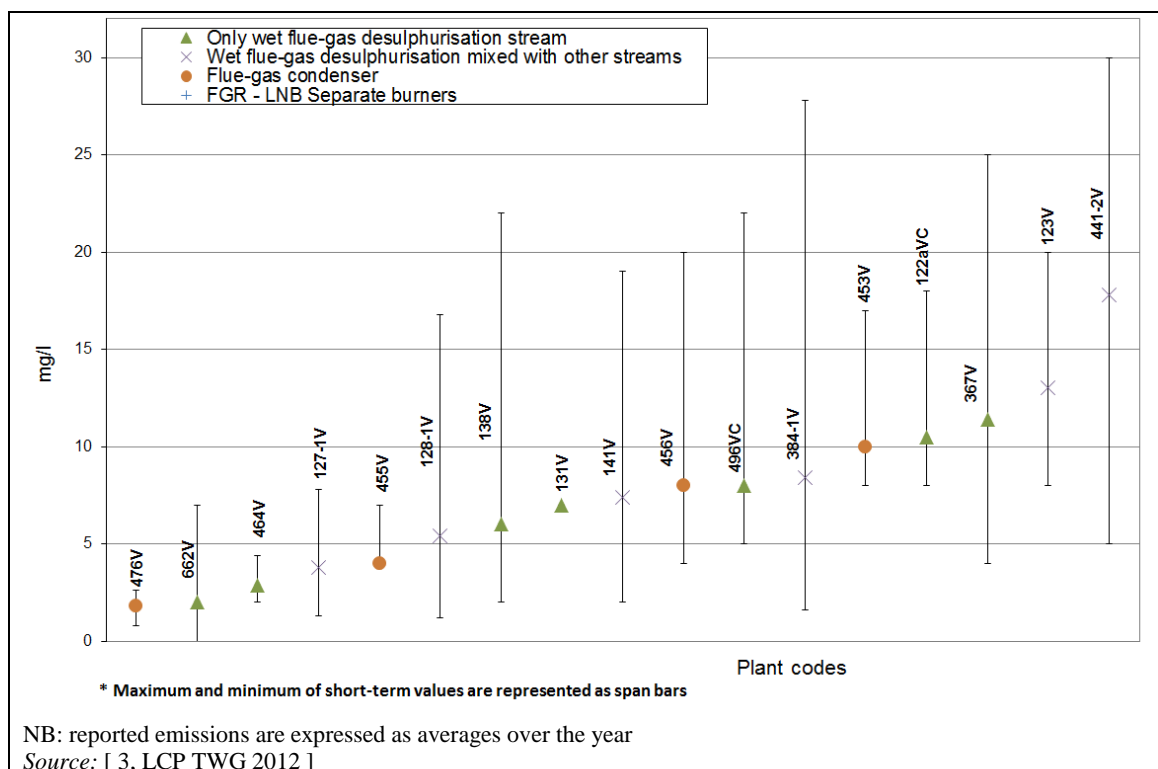

Figure 3.58: Total suspended solids (TSS) emissions in direct discharges to a receiving water body

TOC/COD emissions

TOC/COD loads in waste water can be reduced by optimised design and operation of combustion and waste gas abatement techniques, independent of the fuel. TOC/COD is also partially co-precipitated during the precipitation of metals.

The parameter COD is widely used for the monitoring of emissions of organic compounds. However, it is increasingly replaced by the parameter TOC which does not require the use of very toxic compounds (i.e. mercury and Cr(VI)) for its measurement. Moreover, high chloride concentrations may impede the measurement of COD.

The COD to TOC ratio is site-specific. Theoretically, it ranges from 0.67 to 5.3 for organic compounds. At the end of the 1990s, a study carried out in Germany examined the COD to TOC ratio in a number of industry sectors. For waste water from the scrubbing of flue-gases from firing systems, the median was 2.7.

For TOC, as shown in Figure 3.59, a number of plants, including plants treating waste water originating exclusively from flue-gas treatment, achieve maximum emission levels below 50 mg/l, while a few achieve maximum emission levels below 20 mg/l. For COD, as presented in Figure 3.60, a number of plants, including plants treating waste water originating exclusively

from flue-gas treatment, achieve maximum emission levels below 150 mg/l, while a few achieve maximum emission levels below 60 mg/l.

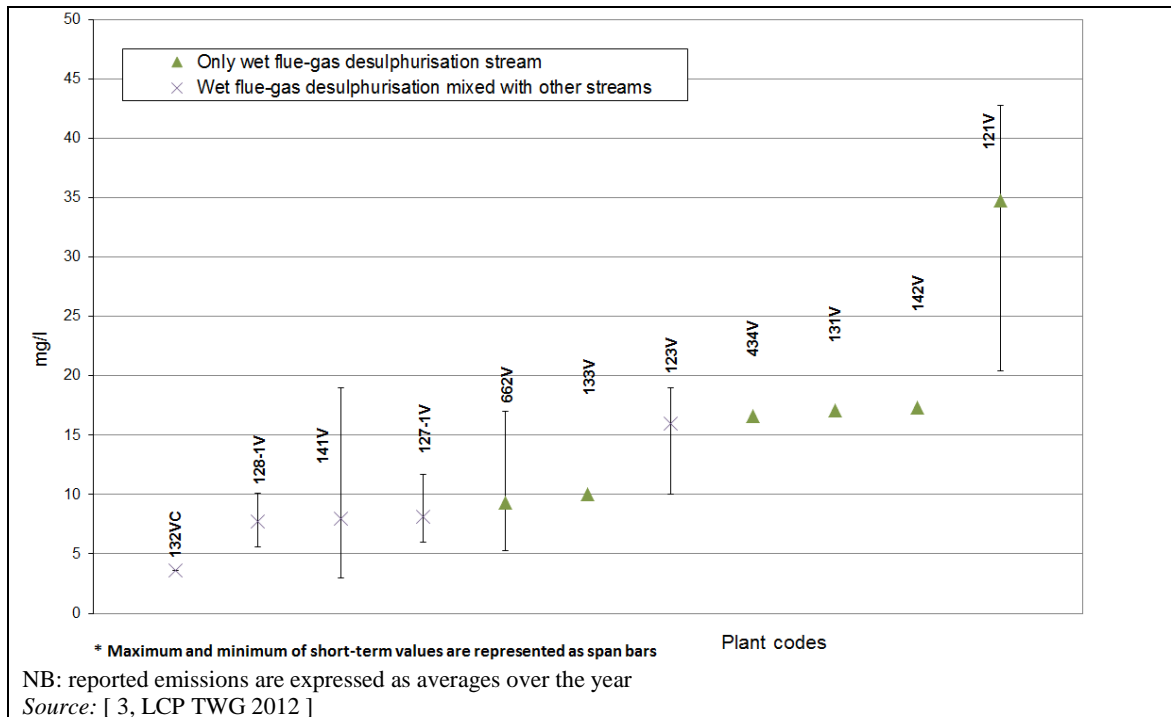

Figure 3.59: Total organic carbon (TOC) emissions in direct discharges to a receiving water body

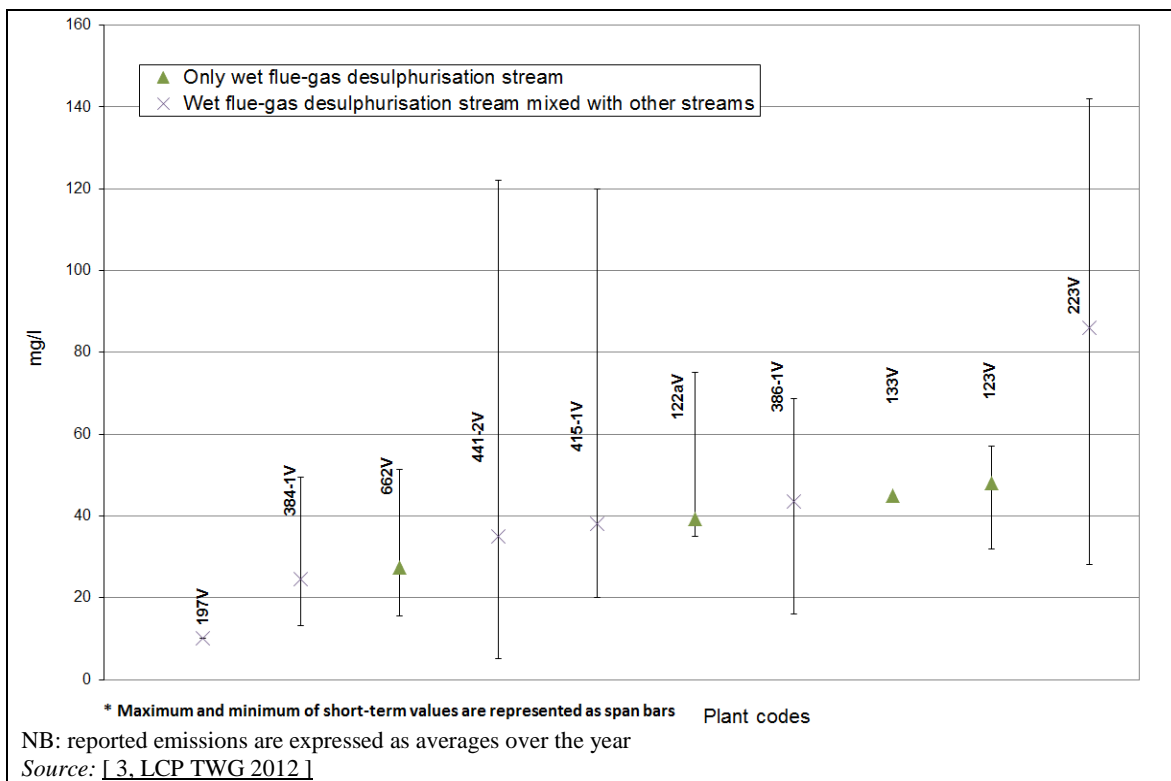

Figure 3.60: Chemical oxygen demand (COD) emissions in direct discharges to a receiving water body

Fluoride emissions

Fluoride levels are usually reduced by precipitation with calcium. In pure water, calcium fluoride has a solubility of 16 mg/l at 20 °C corresponding to a fluoride concentration of 7.8 mg/l. Using the solubility product constant and assuming a calcium concentration of 300 mg/l (corresponding to a calcium sulphate concentration of 1 000 mg/l), a theoretical fluoride concentration of 1.3 mg/l could be calculated. In practice, however, treated waste water frequently has much higher fluoride concentrations because of slow nucleation and/or high ionic strength. As shown in Figure 3.61, a number of plants, including plants treating waste water originating exclusively from flue-gas treatment and including Plants 121, 122 and 138 using precipitation with calcium achieve maximum emission levels below 25 mg/l, while a few achieve maximum emission levels below 10 mg/l.

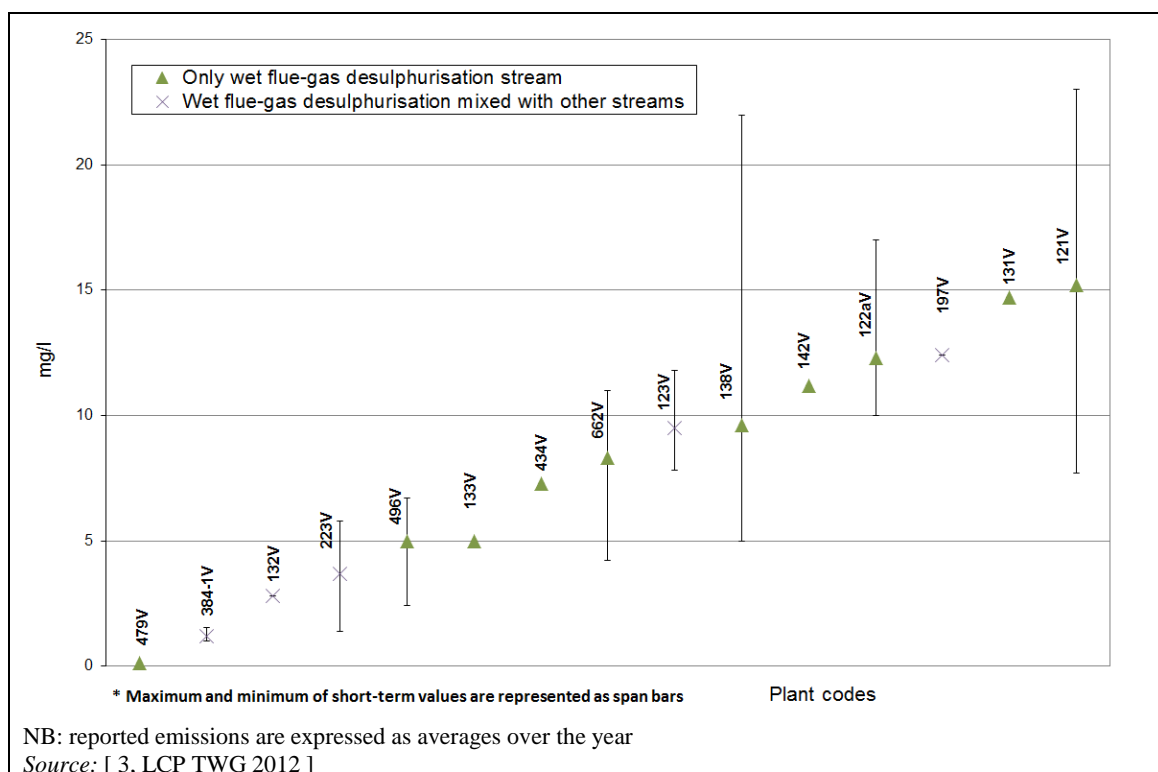

Figure 3.61: Fluoride (F⁻) emissions in direct discharges to a receiving water body

Sulphate emissions

Figure 3.62 represents the yearly sulphate emissions in direct discharges to a receiving water body, where the waste water originates from the combustion plants' flue-gas treatment alone or mixed with other waste water streams from the plant. Sulphate levels in untreated waste water from flue-gas treatment depend on the raw water quality, the fuel quality and the water recycling rate. Sulphate levels are usually reduced by precipitation with calcium salts (limestone/lime). Other techniques such as evaporation-crystallisation and precipitation with barium are rarely used and imply cross-media effects. Residual sulphate levels thus depend on the solubility of calcium sulphate, which increases with increasing temperatures and salinity (e.g. chloride concentration). The chloride concentration is determined by the raw water quality (e.g. seawater), the fuel quality and the water recycling rate in the flue-gas treatment system.

A number of plants, including plants treating waste water originating exclusively from flue-gas treatment and including Plants 123 and 131 using precipitation with calcium achieve maximum sulphate emission levels below 2 g/l, while a few achieve maximum emission levels below 1.3 g/l. The reported chloride concentrations are in all cases below 5 g/l. The concentration range of 1.3–2 g/l corresponds to the solubility of calcium sulphate in low-salinity water.

Sulphate levels in waste water with chloride levels above 5 g/l were not reported, but the literature indicates that the solubility of sulphate could increase up to 4 g/l and higher at chloride levels of about 20 g/l, depending on the temperature.

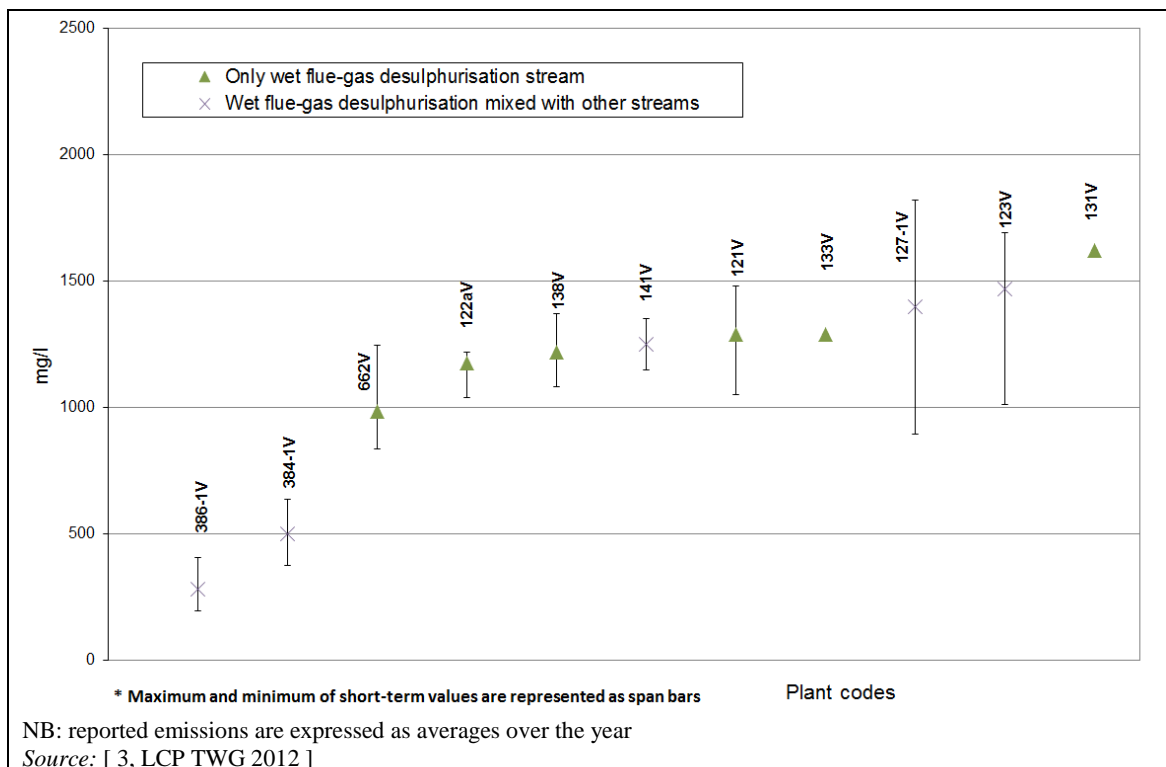

Figure 3.62: Sulphate (SO_4^{2-}) emissions in direct discharges to a receiving water body

Sulphide / sulphite emissions

As shown in Figure 3.63 and Figure 3.64, few sulphide and sulphite emission data were reported. Maximum sulphide emission levels below 0.1–0.2 mg/l and sulphite emissions below 20 mg/l are set in the 2006 LCP BREF.

No EN standard for the measurement of sulphide is available. ISO 13358 allows the measurement of easily released sulphide and ISO 10530 the measurement of dissolved sulphide, both in the concentration range of 0.04–1.5 mg/l. Emission levels were reported on the basis of easily released sulphide, which covers the sum of dissolved sulphides and of those undissolved sulphides that are easily released upon acidification.

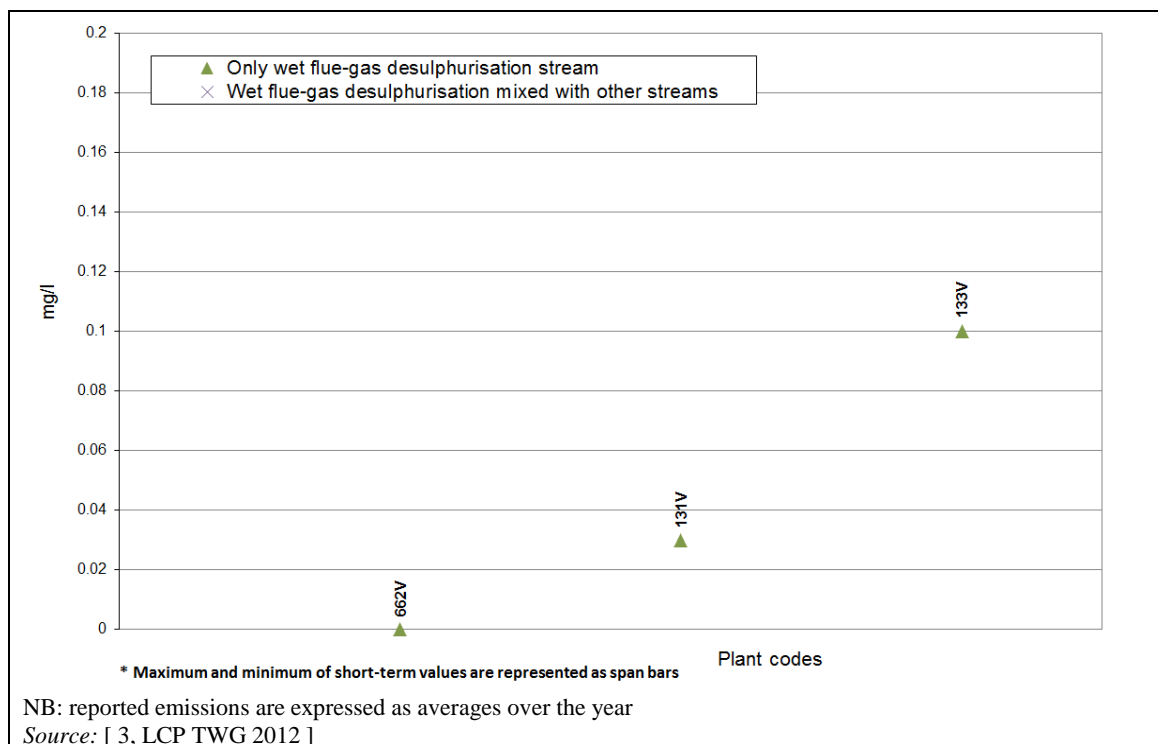

Figure 3.63: Sulphide (S^{2-}) emissions in direct discharges to a receiving water body

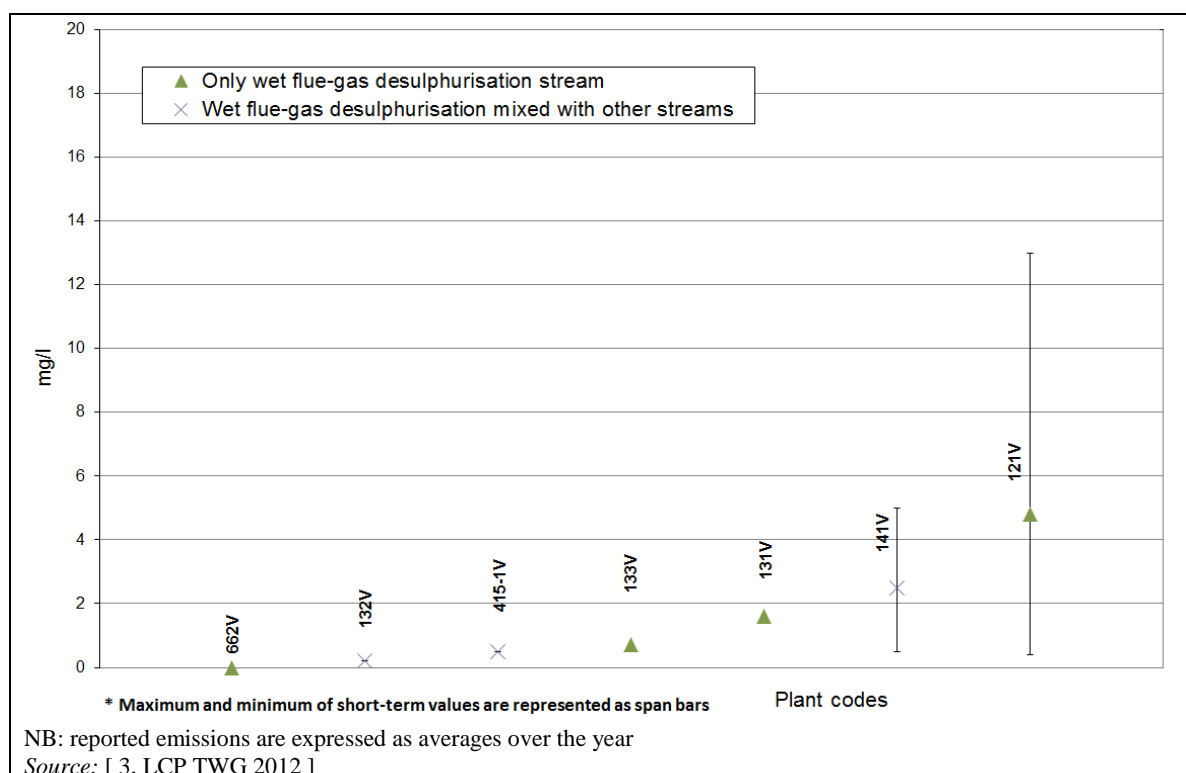

Figure 3.64: Sulphite (SO_3^{2-}) emissions in direct discharges to a receiving water body

Metal emissions

Metals show different properties and toxicities. Emissions for relevant metals and metalloids (i.e. As, Cd, Cr, Cu, Hg, Ni, Pb, Zn) are shown in Figure 3.65 to Figure 3.72. Dissolved metals are usually removed by precipitation with hydroxide and (organo)sulphides. As and Hg cannot be precipitated with hydroxide, but with (organo)sulphides. A number of plants, including plants treating waste water originating exclusively from flue-gas treatment, achieve the

following maximum emission levels: As 50 µg/l, Cd 5 µg/l, Cr 50 µg/l, Cu 50 µg/l, Hg 3 µg/l, Ni 50 µg/l, Pb 20 µg/l, and Zn 200 µg/l. A few plants achieve the following maximum emission levels: As 10 µg/l, Cd 2 µg/l, Cr 10 µg/l, Cu 10 µg/l, Hg 0.2 µg/l, Ni 10 µg/l, Pb 10 µg/l, and Zn 50 µg/l.

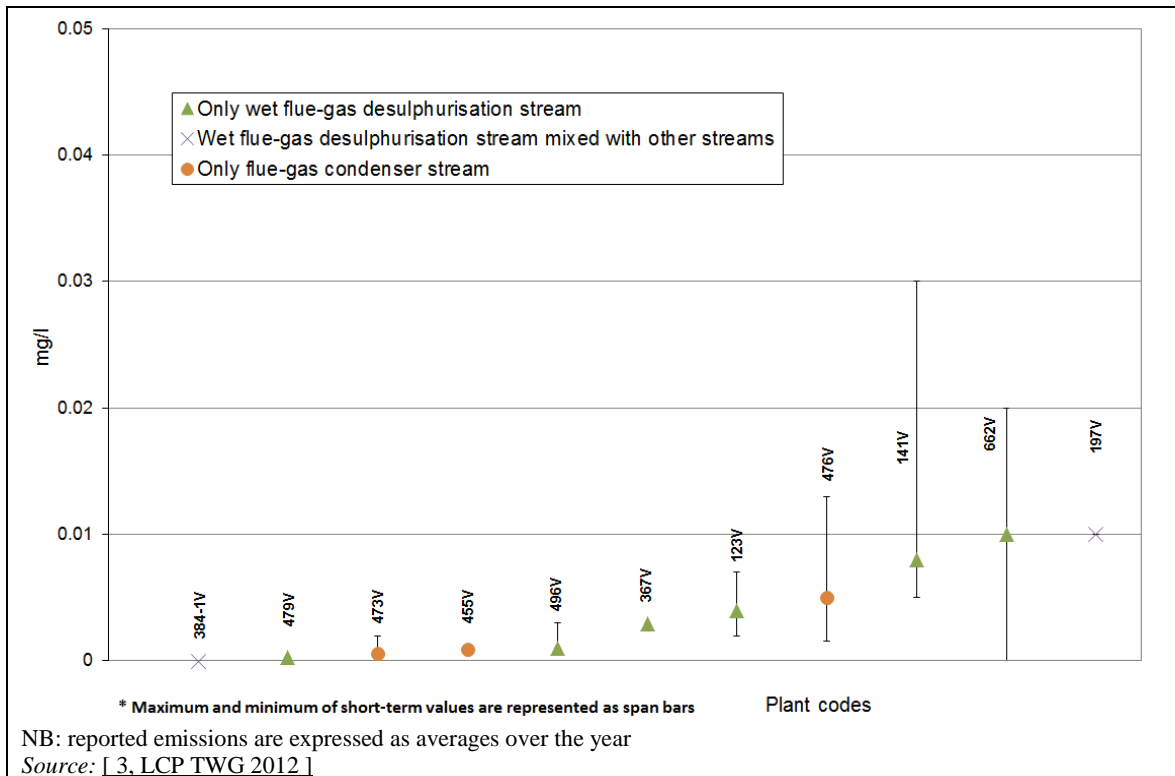

Figure 3.65: Arsenic (As) emissions in direct discharges to a receiving water body

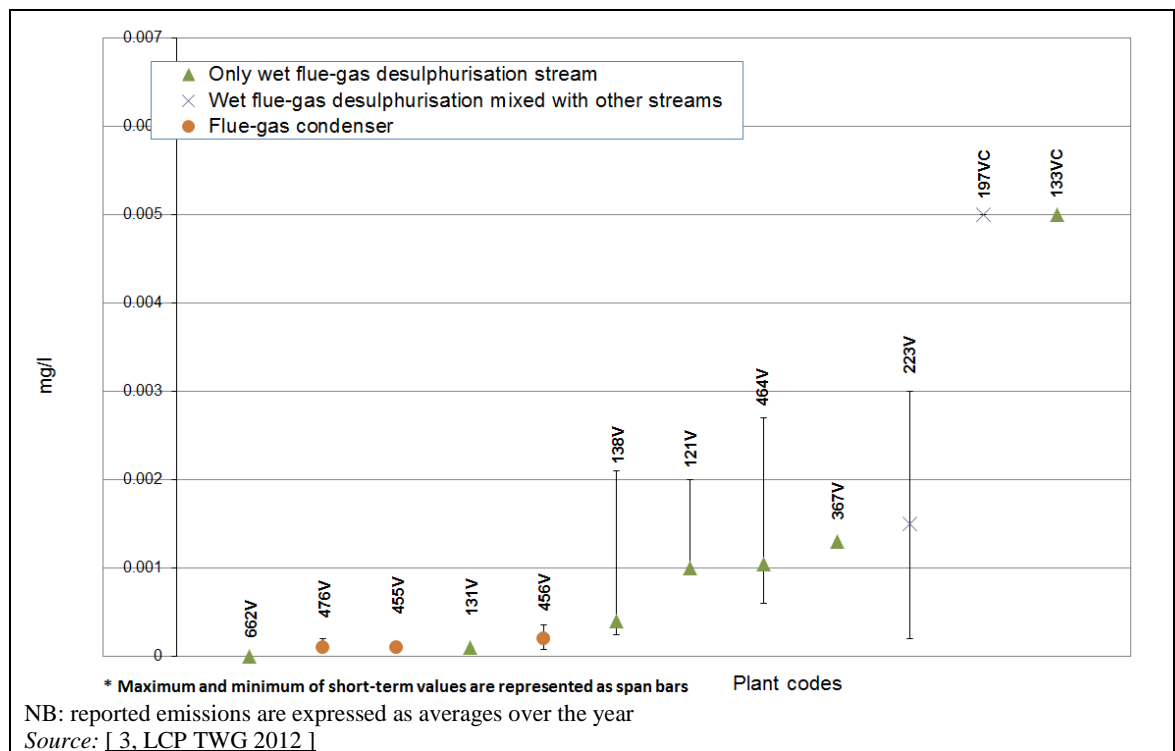

Figure 3.66: Cadmium (Cd) emissions in direct discharges to a receiving water body

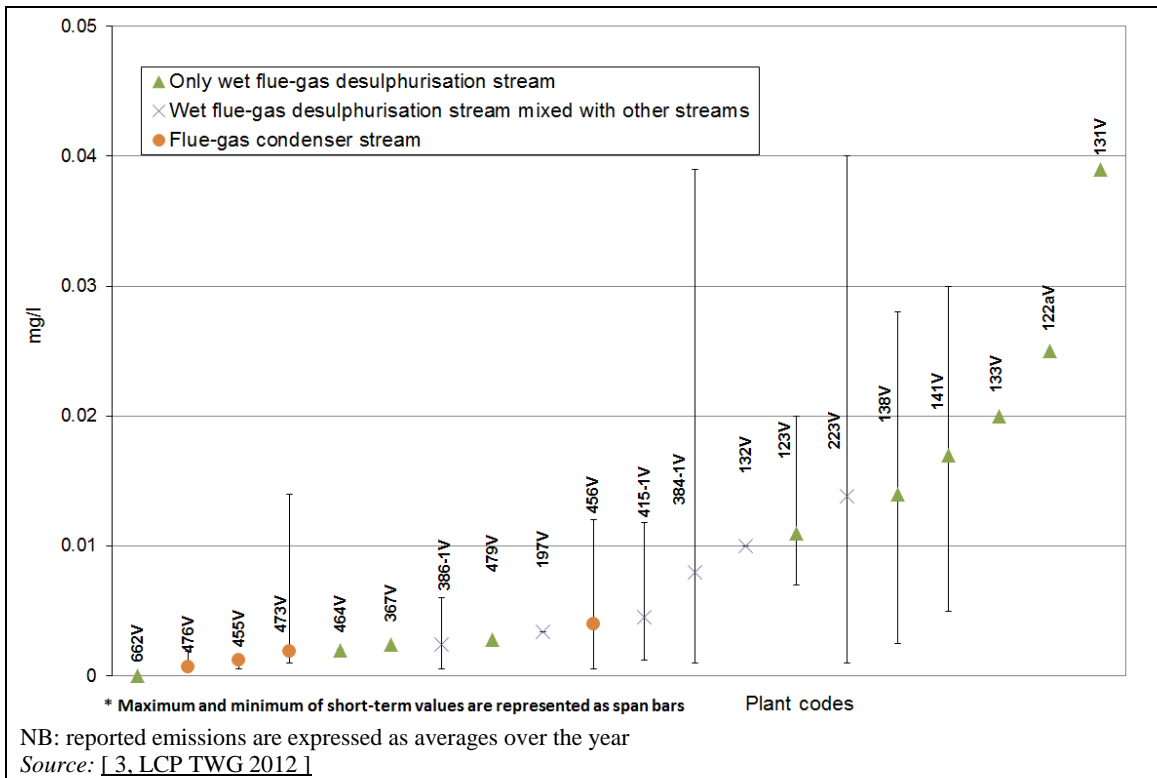

Figure 3.67: Chromium (Cr) emissions in direct discharges to a receiving water body

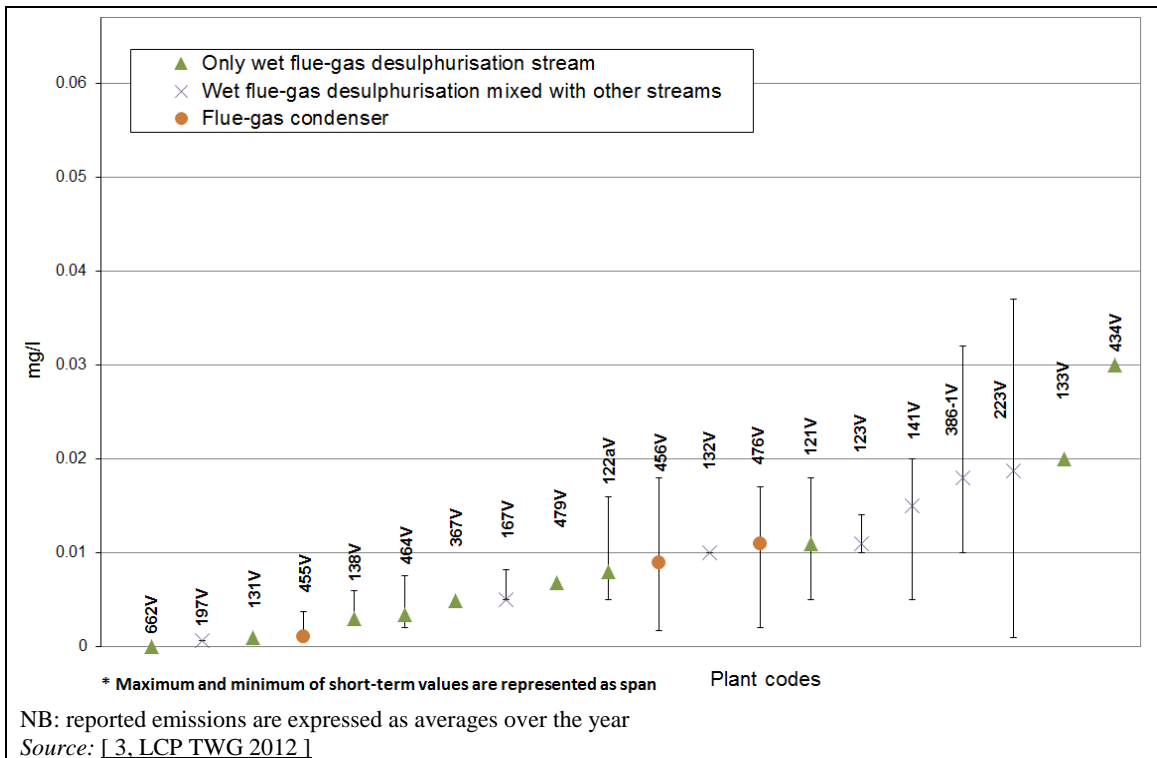

Figure 3.68: Copper (Cu) emissions in direct discharges to a receiving water body

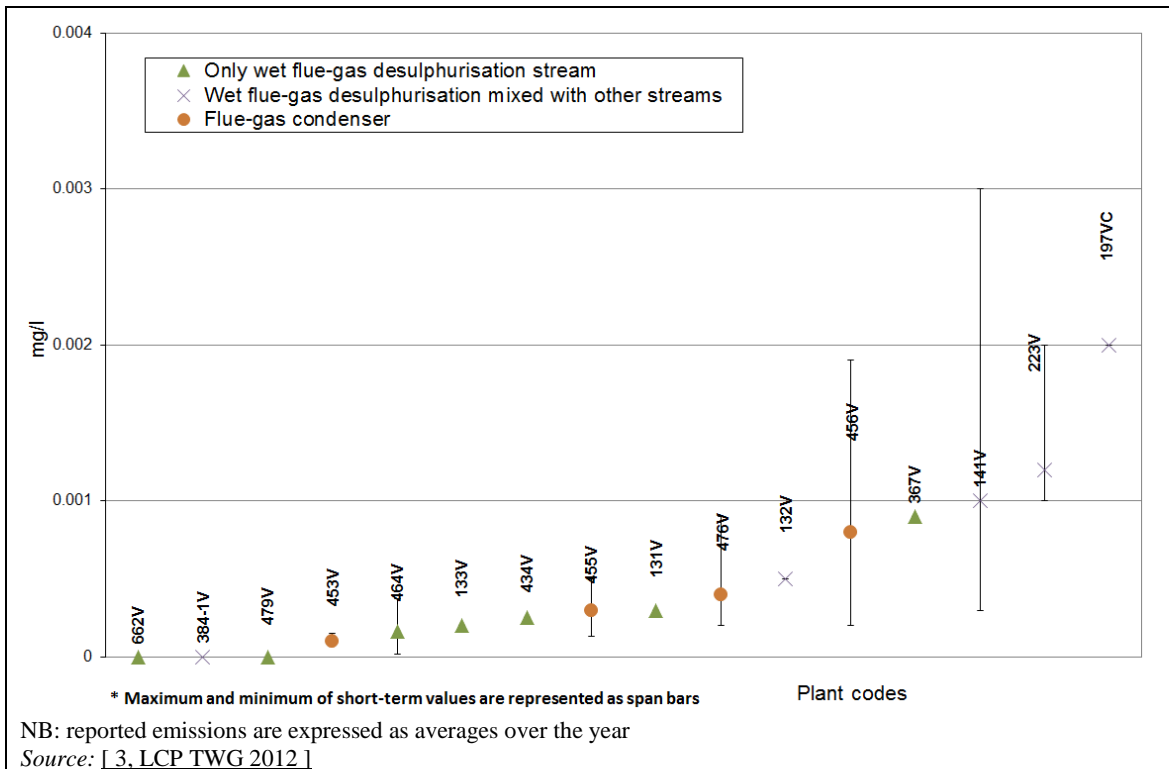

Figure 3.69: Mercury (Hg) emissions in direct discharges to a receiving water body

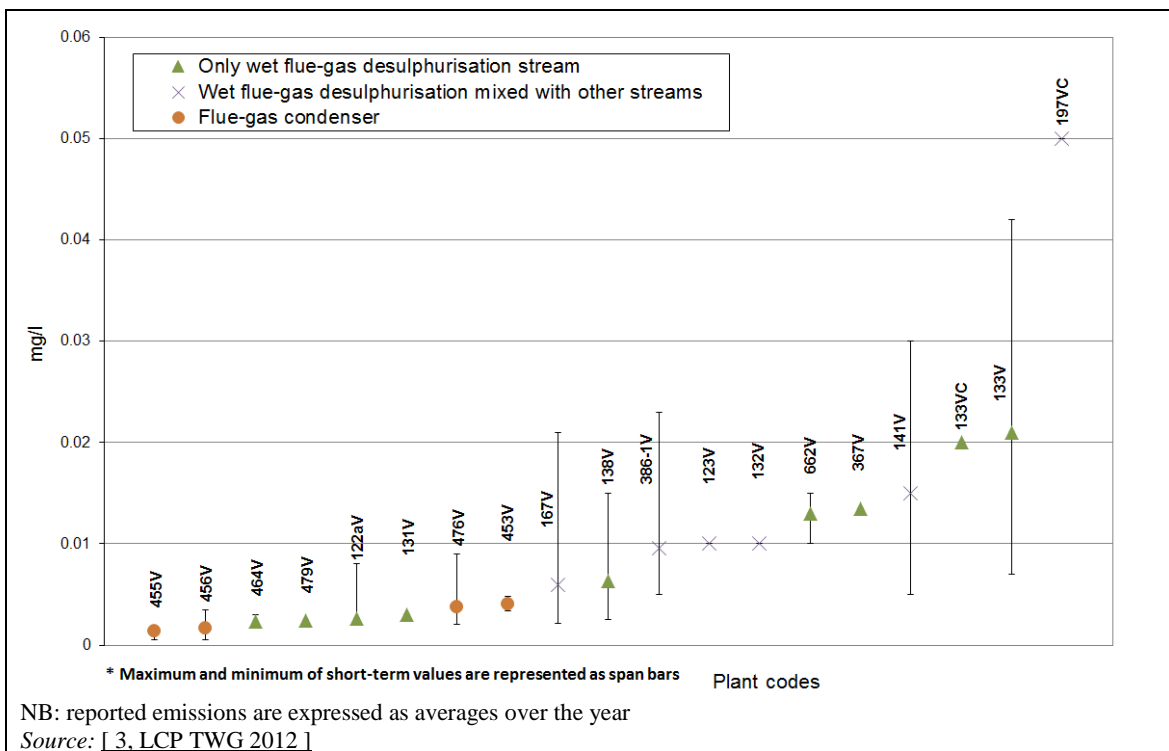

Figure 3.70: Nickel (Ni) emissions in direct discharges to a receiving water body

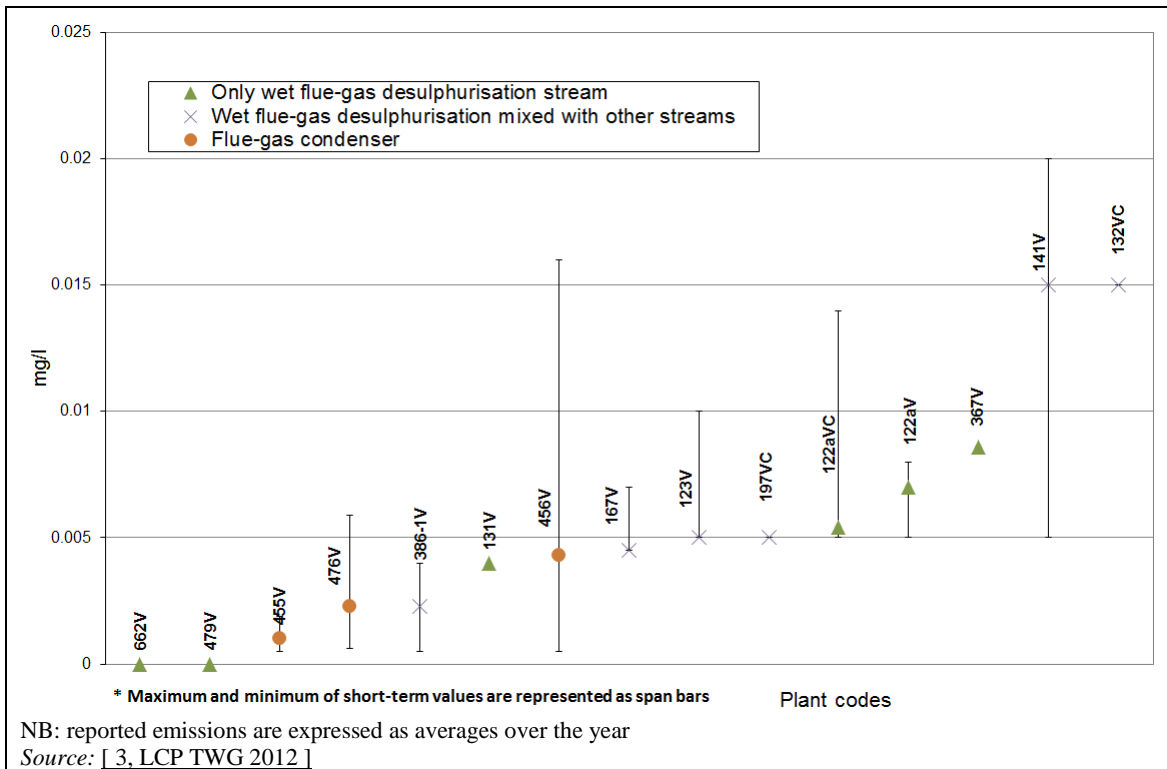

Figure 3.71: Lead (Pb) emissions in direct discharges to a receiving water body

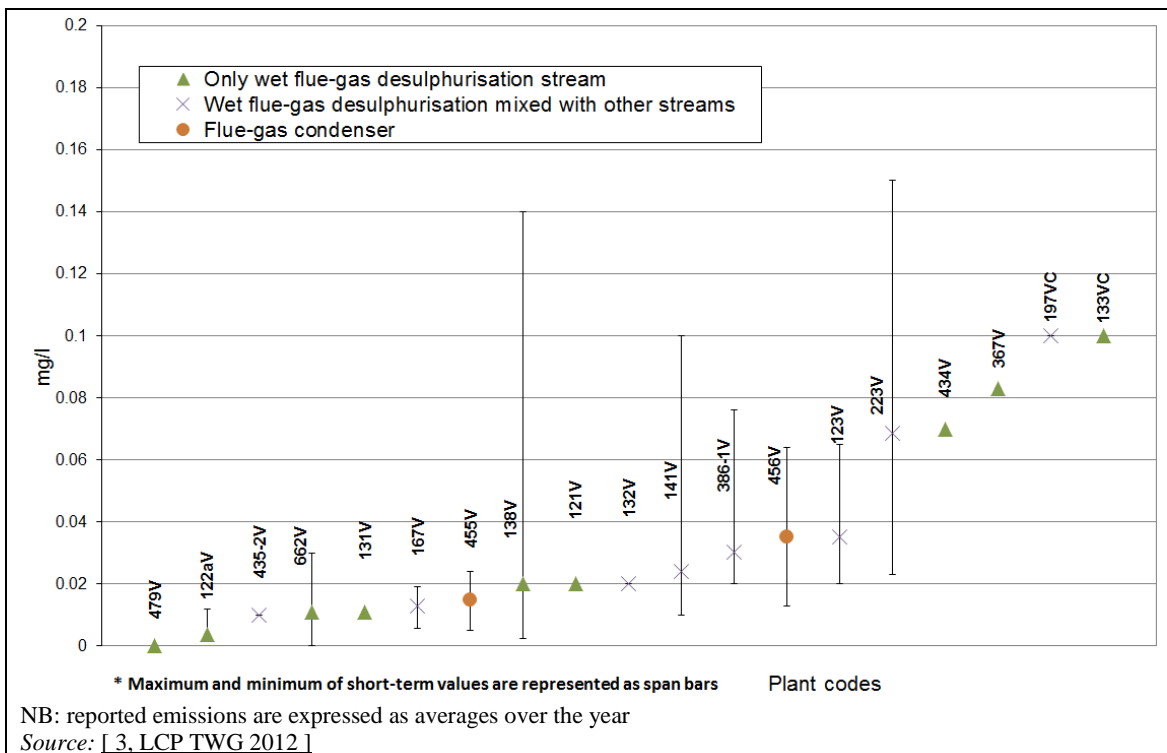

Figure 3.72: Zinc (Zn) emissions in direct discharges to a receiving water body

3.2.5 Techniques for the management of residues

Details and information about the handling of residues are given in the EFS BREF.

To reduce the quantity of waste sent for disposal from combustion and/or abatement techniques, it is important to organise operations in the following order of priority and take into account life-cycle thinking:

- a waste prevention, e.g. maximise the proportion of residues which arise as by-products;
- b waste preparation for reuse, e.g. according to the specific requested quality criteria;
- c waste recycling;
- d other waste recovery (e.g. energy recovery).

Some techniques may be used for this purpose, i.e. the preparation of spent catalysts for reuse (e.g. up to four times for SCR catalyst, depending on the mechanical condition of the catalyst and on the required performance related to NO_x and NH₃ emissions), energy recovery by using waste in the fuel mix (e.g. carbon-rich ash and sludges), generation of FGD gypsum as a by-product and/or recycling or recovery of residues in the construction sector.

In relation to the generation of gypsum as a by-product, the quality of the calcium-based reaction residues generated by wet FGD is optimised so that they can be used as a substitute for mined gypsum (e.g. as raw material in the plasterboard industry). The quality of the limestone used in wet FGD influences the purity of the gypsum produced.

The optimisation of the quality of the gypsum generated as a by-product in wet desulphurisation systems may be carried out using a FGD pre-scrubber and a dehydration centrifuge.

Recovery or recycling of residues (e.g. from the semi-dry desulphurisation processes, fly ash, bottom ash) as a construction material (e.g. in road-building; in concrete production, to replace sand; or in the cement industry).

The optimisation of the quality of the bottom ash generated as a by-product of the combustion may be carried out by means of dry de-ashing and afterburning.

3.2.5.1 Optimisation of gypsum quality

Description

Optimisation of the quality of the gypsum generated as a by-product in wet desulphurisation systems using two-stage dewatering systems including hydrocyclone and vacuum belt filter with centrifuge, or more exceptionally a FGD pre-scrubber and a dehydration centrifuge.

Technical description

The two-stage dewatering systems including hydrocyclone and vacuum belt filter with centrifuge allow the separation of gypsum crystals by size to return small crystals into the scrubber and to remove large crystals for dewatering.

FGD pre-scrubbers can be used to reduce levels of acid-forming constituents (flue-dust, F, Cl), thus improving the gypsum quality. In addition, the gypsum obtained is dehydrated by means of a centrifuge.

Achieved environmental benefits

Increased level of gypsum reuse thanks to a reduction in chloride/fluoride levels in the gypsum (saleable by-product).

Environmental performance and operational data

No information provided.

Cross-media effects

None.

Technical considerations relevant to applicability

Applicable to slag tap boilers fitted with wet desulphurisation systems.

Economics

Revenues from the gypsum sales.

Driving force for implementation

No information provided.

Example plants

Plant 121.

Reference literature

No information provided.

3.2.5.2 Optimisation of bottom ash quality

Description

Optimisation of the quality of the bottom ash generated as a by-product of the combustion, by means of dry de-ashing and afterburning.

Technical description

Unburnt portions of fuel drop out of the boiler onto a conveyor belt (dry de-ashing), below the boiler hopper, and are redirected to the boiler where they are reburnt (afterburning). Due to the partial vacuum prevailing in the boiler, the flue-gases produced are passed into the flue-gas conduit.

Dry de-ashing avoids the need for a separate effluent treatment plant (reduction in COD) and increases the value of the ash by reducing the carbon content. At the same time, afterburning also reduces the water content of the ash.

The air used to cool the ash re-enters the boiler, recovers a significant amount of energy and increases the boiler efficiency.

Achieved environmental benefits

- Reduced emissions to water and reduced waste generation: there is no generation of de-ashing process effluent that would require separate treatment, thus avoiding COD emissions from the combustion and ash treatment processes.
- Improved energy efficiency.

Environmental performance and operational data

The boiler efficiency, compared with the use of a wet bottom ash handling system, is improved by 0.1–0.2 percentage points for normal bituminous coals and by 0.5 percentage points for low-rank coals.

Cross-media effects

Minimal additional emissions in the flue-gas stream as a result of the afterburning process.

Technical considerations relevant to applicability

- Afterburning applicable to dry-bottom boilers.
- Dry bottom ash handling only applicable to plants combusting solid fuels. There may be technical restrictions that prevent retrofitting to existing combustion plants.

Economics

Plant-specific.

In the example of Plant 142: capex about EUR 4.5 million and opex about EUR 170 000/yr (2010 price levels).

Driving force for implementation

- Reduction in emissions (effluent/COD).
- Reduction in quantities of additional feedstocks (e.g. activated carbon, effluent treatment).
- Improvement in ash quality.

Example plants

Plant 142.

Reference literature

[225, Carrea et al. 2014]

3.2.6 Techniques to prevent emissions to soil and groundwater

Soil and groundwater contamination is more widely related to uncontrolled and/or unplanned (accidental) discharges. This contamination may be difficult and costly to mitigate. IED Article 14(1) (b) and (c) require permit conditions to include measures to protect soil and groundwater). Measures to prevent or control soil/groundwater contamination may be included in the EMS.

3.2.7 Techniques to reduce noise emissions**3.2.7.1 Strategic planning of the location of equipment, units and buildings****Description**

This technique consists of strategically planning the location of equipment, units and buildings with the aim of increasing the distance between the emitter and the receiver and of using buildings or other structures as noise screens.

Technical description

The low-noise design of plants and sites aims at minimising the resulting environmental noise at the closest receptor premises. A simple, but in general effective, method is to increase the distance between the emitter and the receiver. In addition, buildings can act as a noise screen for other sources. In the case of existing plants, it may be possible to relocate specific units.

The basic options to reduce noise are to modify the noise source, to change the transmission path of the noise or to make changes affecting the receiver. The first step that needs to be taken in any noise assessment is to identify the principal sources and paths of noise. The prediction of the levels of environmental noise at a certain distance from the source(s) may be based on ISO 9613-2. A noise management plan where a noise nuisance at sensitive receptors is expected or sustained may be implemented. A method to decrease the level of noise is to increase the distance between the receiver and the source.

Optimising the location of noisy equipment and of the whole plant is, therefore, perhaps the most cost-effective means of avoiding noise problems. A straightforward method to remedy noise effects is to modify the noise generation mechanism. Another alternative is to place the noise source in an enclosure. Acoustic barriers are commonly used to modify the sound path. Inside the buildings, the use of noise-absorptive material, particularly on the walls and ceiling,

is an effective method to decrease reflection or reverberation inside the building. If the internal surfaces of the room are totally reflective, the noise theoretically approaches infinity. This is why interior noise levels are, in some cases, controlled by adding absorptive material inside the building.

Achieved environmental benefits

Reduction of noise emissions.

Environmental performance and operational data

No information provided.

Cross-media effects

- In the case of existing plants, some raw materials and energy are consumed for the relocation of equipment or production units.
- Reduced accessibility for maintenance and inspections.

Technical considerations relevant to applicability

The technique is applicable to new plants. The relocation of equipment and production units in existing plants is subject to space availability.

Economics

Optimising the layout of noisy equipment and of the whole plant/site is probably the most cost-effective means of reducing noise emissions. In the case of existing plants, relocation may lead to excessive costs.

Driving force for implementation

Environmental legislation.

Example plants

No information provided.

Reference literature

[301, UK Environment Agencies 2004]

3.2.7.2 Primary techniques: noise reduction at source

Description

Primary techniques aim at reducing noise at source. These include management, operational and maintenance techniques as well as low-noise equipment and buildings.

Technical description

Primary techniques to reduce noise emissions at source include the following [301, UK Environment Agencies 2004]:

1. A noise-reduction programme, which may be part of the EMS, including the following steps:
 - a) listing of all major sound sources and determination of their sound power levels, in octave segments and including analysis of impulses;
 - b) determination of the affected areas such as housing areas;
 - c) computer-based calculation of the noise propagation (modelling of the site and its surroundings) including checks of the real noise level in neighbouring areas by direct measurements;
 - d) ranking of the noise sources according to their relevance for individually affected areas (separately for day- and night-time);

- e) evaluation of noise abatement techniques with regard to their relevance for the noise level in affected areas and the estimated costs;
 - f) identification of the most cost-effective combination of techniques that ensures compliance with the legal requirements such as noise zoning;
 - g) Verification of the programme efficiency and monitoring of noise emissions at regular intervals.
2. Operational and management techniques in buildings containing noisy equipment:
 - a) improved inspection and maintenance of equipment to prevent excessive wear and failures leading to higher noise generation (e.g. in blowers and bearings);
 - b) closing of doors and windows of covered areas;
 - c) equipment operation by experienced staff;
 - d) avoidance of noisy activities at night-time;
 - e) provision for noise control during maintenance activities.
 3. Use of low-noise equipment.
 4. Installation of noise-reducers (e.g. mufflers, silencers) on equipment and ducts. For noise reduction in blowing lines and safety valves, special mufflers are used based on the 'throttling principle'. Absorptive mufflers are suitable for reducing noise that covers a wide frequency band. Typical examples are a lined duct, a silencer consisting of parallel lined plates or a lined pressure chamber. Reactive mufflers are mainly based on the geometry of the muffler. These mufflers are effective only at specific frequencies or over a narrow frequency band. Expansion chambers or cavity resonators are typical examples of reactive mufflers. The air in the cavity forms a spring that affects the airflow directed through a neck to the cavity. The airflow acts as a mass, producing a low-frequency tuning effect in a very limited frequency band. Commercial mufflers are often combinations of the absorptive and the reactive types. In valves, the broadband noise usually relates to the pressure drop, and noise can be reduced by arranging for the pressure drop to occur in several stages. The use of mufflers or silencers, increased pipe-wall thickness and the lining of piping with an absorptive or isolating material are common solutions to noise problems at existing power plants.
 5. Vibration insulation of machinery, good design and decoupled arrangement of noise sources and potentially resonant components such as compressors and ducts. Rotating machines such as turbines, generators, pumps, compressors, and electric motors are important sources of vibration and noise in power plants. The noise is often caused by machine vibration, which creates structure-borne noise. An effective method to limit the spreading of structure-borne noise is the use of machine foundations supported by vibration isolators such as specifically tuned springs or rubber elements. The principle of isolators is that the natural frequency of the system resting on the isolators is much lower than the principal running frequency of the machine. The isolated system balances the excitation force by inertia. The greater the mass on isolators, the smaller the vibrations of the system are, but, in any case, the isolators considerably decrease the vibrations passing through them to the surrounding structures. If the machine is on an isolated foundation, the connections from the machine to other structures, like pipes and ducts, have to be flexible. This effectively prevents the spreading of structure-borne noise to the ducts and piping. Expansion joints and bellows are examples used for such isolation purposes. With respect to flow-generated noise, piping and ducts should be designed for smooth uniform fluid flow. Sudden changes in geometry increase noise that strongly depends on the flow velocity. In some cases, the noise is even exponentially proportional to the fluid velocity, and the most effective method to reduce the noise is thus to decrease the local fluid velocity. One practical method for doing this is to provide piping with a sufficient diameter and the use of a large bending radius. Piping noise is of two characteristic types: noise with a broad frequency range and noise concentrated at discrete frequencies. Pumps, fans and blowers produce noise at their blade passing frequencies. The latter depend on the number of blades around the impeller. These discrete frequencies can sometimes be affected by a special design of the machine.
 6. Enclosure of noisy equipment (e.g. compressors) in separate structures such as buildings or soundproofed cabinets with an internal lining made of absorbent material.

7. Soundproofing of buildings to shelter any noisy operations potentially including:
 - a) sound-absorbing materials in walls and ceilings;
 - b) sound-isolating doors;
 - c) double-glazed windows.

Achieved environmental benefits

Reduction of noise emissions.

Environmental performance and operational data

Target noise levels in permits are normally set at measurement points outside the site boundaries and on a case-by-case basis. These levels usually differ depending on the affected area (residential or business) and the time of day (daytime, typically 7.00–22.00, or night-time, typically 22.00–7.00). The operator of a plant usually has to give information on noise dissemination and measures taken for noise abatement. As most plants operate continuously all day and night, the target noise levels during the night will determine the techniques for the whole site. In the case of impulse noise, it is common practice to add 5 dB(A) to measurement results when comparing to limit values.

Cross-media effects

Noise insulation may limit access for maintenance and inspections.

Technical considerations relevant to applicability

- Technique 2.b) can be limited by heat accumulation, requiring forced removal of heat.
- The applicability of noise control equipment may be restricted by lack of space.

Economics

Noise-reducing techniques lead to additional investment and operational costs which are generally higher for existing plants than for new plants.

Driving force for implementation

- Environmental legislation.
- Health and safety legislation at the workplace.

Example plants

No information provided.

Reference literature

[301, UK Environment Agencies 2004]

3.2.7.3 Secondary techniques: noise abatement

Description

Secondary techniques aim at reducing noise propagation by inserting appropriate obstacles such as protection walls, embankments and buildings.

Technical description

If primary noise reduction techniques (see Section 3.2.7.2) are not sufficient to reach the required noise target levels, secondary techniques may be considered appropriate.

In many cases, the noise may spread through the entire casing and may be difficult to correct by changes in the machine or its connections. The solution then is to either line the machine with an absorptive or isolating material or to use separate enclosures.

In order to screen the source of the noise, obstacles such as protection walls, embankments and buildings are inserted between the emitter and the receiver. [301, UK Environment Agencies 2004]

Achieved environmental benefits

Reduction of noise emissions.

Environmental performance and operational data

No information provided.

Cross-media effects

Some raw materials and energy are consumed for erecting noise-absorbing obstacles.

Technical considerations relevant to applicability

The use of secondary techniques is subject to space availability.

Economics

No information provided.

Driving force for implementation

Environmental legislation.

Example plants

No information provided.

Reference literature

[301, UK Environment Agencies 2004]

4 GASIFICATION

The gasification technologies covered within this document include techniques linked to combustion processes and with a minimum total rated thermal input of 20 MW_{th} (i.e. 'fuel pretreatment technology' for LCPs). While a number of different gasification technologies are included in this definition, at the time of writing (2013), no dedicated pyrolysis or liquefaction technologies with a size relevant for the purpose of this document have been identified. Therefore, the technologies described in this document focus mainly on gasification processes.

Gasification is a partial oxidation process whereby a carbon source such as coal, pet coke, heavy oil, biomass, heavy residues from a crude oil refinery process, or RDF, is converted, by means of heat with a limited/controlled supply of oxygen, into carbon monoxide (CO) and hydrogen (H₂), plus carbon dioxide (CO₂) and possibly hydrocarbon molecules such as methane (CH₄), and tar. This mix of gases is known as 'producer gas' or 'synthesis gas' (syngas); the precise characteristics of the gas will depend on the gasification parameters, such as the temperature, the type of feedstock fed to the gasification process, and the oxidiser used. The oxidiser may be air, in which case the syngas will also contain nitrogen (N₂), or steam or oxygen. The syngas can be used in many different ways, e.g. to produce power, steam, hydrogen and basic chemicals, such as methanol and ammonia.

Gasification is an efficient means of converting low-value fuels and residuals into a syngas, as it can be applied to a variety of feedstocks: fossil fuels such as coal or oil, biomass (such as wood, agricultural waste or various crops), manure, asphalt, sewage sludge, plastics and municipal solid waste. In addition, gas cleaning techniques can be used to remove corrosive ash elements, such as chloride and potassium, allowing clean gas production from otherwise problematic fuels.

A number of factors contribute to a growing interest in gasification. The product and feedstock flexibilities are two key reasons for the popularity of gasification in a market characterised by volatile oil and natural gas prices. Furthermore, using the syngas is potentially more efficient than direct combustion of the original fuel because it can be combusted at higher temperatures or even in fuel cells. In addition, gasification syngas is much denser than combustion flue-gases produced from the same fuel, and consequently the pollutants are at much higher concentrations, making it easier to remove them more efficiently before final use. For this reason, gasification systems generally offer environmental advantages over competing combustion systems, due to the ability to achieve extremely low emissions, e.g. of sulphur oxides and dust.

Gasification process

The following reactions are important in coal gasification:

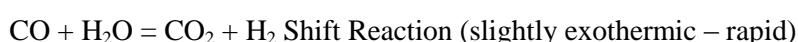
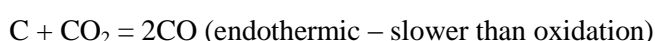
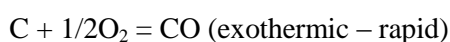
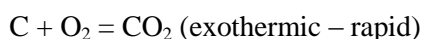

High pressures and low temperatures favour the methanation reactions. However, in most cases the methane content is higher than would be predicted by equilibrium alone, as methane is also

formed during the primary devolatilisation (thermal decomposition of the coal's volatile compounds) of the coal (this methane has sometimes been called 'prompt' methane).

Under the reducing conditions of gasification, the sulphur in the coal is converted primarily to hydrogen sulphide (H_2S), with ~3–10 % of the sulphur converting to carbonyl sulphide (COS). This typically necessitates the use of a COS hydrolysis reactor to convert the COS to H_2S , prior to H_2S removal by well-known solvent absorption processes widely used in the gas processing and petroleum industries.

Gasification conditions favour the conversion of fuel-bound nitrogen to gaseous nitrogen and ammonia (NH_3). Higher temperatures favour the further destruction of ammonia to nitrogen and hydrogen, so the ammonia content of the raw syngas is primarily a function of the gasifier outlet temperature. Small amounts of HCN and other sour gases like ammonia, sulphur or halide compounds are present too and can be treated in a wet scrubber system.

Tars, oils, and phenols survive in the lower temperature outlets of fixed-bed and fluidised bed gasifiers and these species contain some of the fuel's oxygen, nitrogen and sulphur as more complex molecules.

In low-temperature gasifiers (fixed-bed and fluidised bed) and especially with high-volatile fuels, such as biomass, municipal solid wastes and lignites, the devolatilisation stage and the secondary cracking and reforming reactions of primary pyrolysis products have a significant role on the overall gasification process performance. The presence of condensable organic compounds, tars, is a special challenge of biomass and waste gasifiers and has a significant effect on the overall gas cleaning process design.

Gasification processes associated with combustion processes

In principle, a gasification process can be connected to all types of combustion plants, as described below.

If the gasification takes place at a relatively low temperature, such as 700–1 000 °C, the syngas has a relatively high level of hydrocarbons compared with high-temperature gasification. As a result it may be used directly, to be burnt in a boiler for heat or electricity generation via a steam turbine with clean-up of the flue-gases to meet the same emission levels as for any combustion process or, with suitable syngas clean-up before combustion, to run a gas turbine or an internal combustion engine for electricity generation.

The combustion chamber for a simple boiler may be close-coupled with the gasifier, or the syngas may be cleaned of longer chain hydrocarbons (tars), transported, stored and burnt remotely. Syngas can also be converted into synthetic natural gas (SNG), which may be transported to consumers via a natural gas network. Gas turbines can work with tars and other liquid or gas hydrocarbons too in specific circumstances.

A gasification system may be closely integrated with a combined cycle gas turbine for electricity generation (IGCC - integrated gasification combined cycle).

Higher temperature gasification (1 200–1 600 °C) leads to very low concentrations of hydrocarbons in the syngas, and a higher proportion of CO and H_2 , making the clean-up process before the final use of syngas easier. This can be used to produce basic chemicals or to synthesise longer chain hydrocarbons, using techniques such as Fischer-Tropsch (FT) synthesis. Gasification for synthesis purposes only is not covered in this document.

Emissions/by-products generation

The emissions/by-products generated from gasification associated with combustion processes include slag/bottom ash from the gasifier, and, depending on the level of syngas cleaning, potentially also dry and/or wet gas cleaning residues, such as fly ash/filter dust from syngas filtration, wet scrubber residues, recovered sulphur, waste water, and spent catalysts.

Because the syngas produced is used directly in the combustion plant, gasification processes associated with combustion processes produce no direct emissions to air, except from possible transport gas emissions, and incineration and flaring, e.g. from syngas cleaning during start-up and shutdown periods. Diffuse emissions from fuel handling and pretreatment, such as dust and VOCs, may be produced.

The characteristics of gasification ashes may be different to ashes produced by direct combustion. Some gasification processes treat ash-containing heavy metals at very high temperatures so that they are released in a glassy and chemically stable form. In this case, the quality – and hence the reuse potential – of the gasification slags may be better than for the corresponding combustion ashes.

For the fly ashes, the quality and reuse potential may vary significantly, depending on the syngas cleaning technology used, the gasification technology and the quality of the original feedstock. Some (coal gasification) fly ashes have a quality similar to coal combustion fly ash and do not contain sorbents, and these ashes may be marketable. In other cases, the filter dust from syngas filtration may contain a mixture of sorbents, unreacted carbon and all the impurities of the original feedstock, and disposal is the only option.

4.1 Applied processes and techniques

Many design variations of gasifiers are available for commercial use. Depending upon the type of flow conditions present in the equipment, they all fall into one of the general categories: fixed-bed (sometimes also called moving-bed), fluidised bed, entrained-flow, and plasma reactor.

The air pollutants contained in the stack emissions from gasification associated with combustion processes are essentially the same as those in the direct combustion systems, and are influenced by the conversion technology employed, the nature of the fuel being processed, and especially by the syngas cleaning processes applied.

If the gasifier is close-coupled with a boiler, the environmental clean-up (air emissions) relies on the main boiler flue-gas cleaning techniques. On the other hand, the opportunity to clean the syngas (upstream cleaning), instead of downstream flue-gas cleaning, presents some advantages over dedicated combustion, e.g. with coal-based IGCC it is possible to achieve sulphur, NO_x and particulate emission values similar to those of CCGTs operating with natural gas.

Some air emission streams other than the one from the turbine stack may arise from IGCC plants, such as tail gas from the Claus unit or streams from venting trains from the grinding and drying of coal. These minor streams are treated with the aim of recovering any valuable material (e.g. the tail gas from the ELCOGAS Claus unit is hydrogenated before being recycled to the COS hydrolysis unit, allowing a higher total sulphur fuel recovery ratio and preventing a new emission point to the atmosphere) or reducing the pollution emitted to air (e.g. the tail gas from the Nuon Claus unit is hydrogenated and treated before discharge to the atmosphere through an incinerator).

In refineries, an IGCC configuration may include the reburning in multiple-hearth furnaces of the compressed sludge generated by the syngas water-scrubbing step. The related emissions to air are covered by the Refining of mineral oil and gas BREF, in particular where multi-fuel firing is dealt with.

Techniques for syngas filtration/cleaning

Syngas cleaning is generally not needed for immediate oxidation or co-firing in boilers, except for removing corrosive compounds when their concentration is higher than can be accepted in the boiler. However, cleaning is essential for direct firing in combustion engines or gas turbines/IGCC plants. Cleaning of sour and sulphur compounds is advisable to avoid corrosion, fouling or other effects in the boilers downstream of the combustion process, and, in the case of combustion in gas turbines, the amount of dust has to be minimal to extend the life of the hot components.

In coal-based IGCC plants, high-efficiency dust removal and desulphurisation of syngas is carried out before direct combustion in gas turbines. This may be accomplished by commercial dust removal and wet scrubbing technologies. Additional separation processes, necessary in refineries, are not needed. The main efficiency penalty of gasification processes to obtain syngas as a fuel in combustion processes is that syngas has to be cooled down enough to remove particles and, mainly, sour and sulphur compounds. But this efficiency penalty is always lower than the efficiency penalty when the cleaning is carried out on the flue-gas after combustion.

Syngas cooling and filtration can be seen as a mature technology, which has regularly been applied in large-scale IGCC plants. Filtration of air-blown CFB gasification gases was developed and thoroughly tested on a pilot scale in early 2000; the first commercial-scale demonstration plant, the Kymijärvi plant, was in the commissioning phase in spring 2012 in Lahti, Finland.

In biomass gasification, the occurrence of tars in the syngas is a specific challenge, and there are two main strategies for dealing with them once they are present in the syngas: removal or *in situ*

conversion. Hot filtration, cyclones and wet scrubbing systems have been utilised for the removal of tar, chlorides, ammonia, and alkaline compounds. Scrubbing cools the gas and produces a waste water stream. An emerging technique is the removal of tars by catalytic cracking, which could reduce or eliminate the waste water, avoid the loss of thermal energy in scrubbing, and enhance gas quality and quantity. Another way to efficiently convert the tars is to keep the gas temperature above the tar condensation temperature until the gas reaches the burners firing the syngas. This technique is used for example at the following gasifiers: Kymijärvi 1, Ruien, and Vaskiluoto. With this method, the high heating value of the tars is, in practice, fully utilised in the boiler, but there may be a need for end-of-pipe cleaning techniques and there may be potential corrosion and deposits on the boiler's heat exchanger surfaces.

As for combustion, most solid- and liquid-fed gasifiers produce solid by-products, primarily bottom ash/slag, depending on the temperature of the gasification process, and fly ash/filter dust from syngas filtration. Sulphur may also be recovered as a solid by-product.

4.1.1 IGCC (Integrated gasification combined cycle) plants

Integrated gasification combined cycle (IGCC) is a technique whose purpose is to produce steam and electric power from a variety of low-grade fuel types with the highest conversion efficiency possible. Impurities are removed from the syngas before it is combusted.

The primary feedstock in large-scale IGCC plants is often coal, petroleum coke, and/or heavy oil or other heavy residues from crude oil refinery processes. These plants often use pure oxygen for gasification (from an air separation unit, ASU), with a gas cleaning system (e.g. Nuon Buggenum, ELCOGAS Puertollano and most large-scale IGCC plants). However, more simple IGCC configurations with biomass also exist, although on a small scale and with different emission levels in the flue-gas depending on the fuel used (e.g. Varnamo, Sweden).

Pressurised gasification is preferred for IGCC plants to avoid large auxiliary power losses in the compression of the syngas to the gas turbine inlet pressure. In addition, since synthesis reactions are generally improved by higher pressure, pressurised gasification is also favoured for the synthesis application. The majority of, but not all, gasification processes currently in use or planned for IGCC applications are oxygen-blown.

There are many variations in the basic layout of an IGCC plant, with the level of integration between the units being the fundamental aspect of the design. Figure 4.1 shows the typical configuration of an IGCC plant, and its integration possibilities.

Some methane is always produced by decomposition of the coal's volatile matter and by thermal reactions of the higher-molecular-weight primary devolatilisation products. At lower gasifier outlet temperatures, more of the methane survives. As both fixed-bed gasifiers and fluidised bed gasifiers have lower outlet temperatures (below the ash slagging temperatures) than the single-stage entrained gasifiers, the syngas from these gasifiers has a much higher methane content, representing typically 10–15 % of the coal's carbon content at 28–35 barg. It must also be noted that because of their operating temperatures, fluidised bed gasifiers also have lower carbon conversion and their ash contains more carbon than the typical slag from slagging gasifiers. Generally, fluidised bed gasifiers are more suited to highly volatile and highly reactive fuels, such as lignites and biomass, than to bituminous coal, which requires high gasification temperatures.

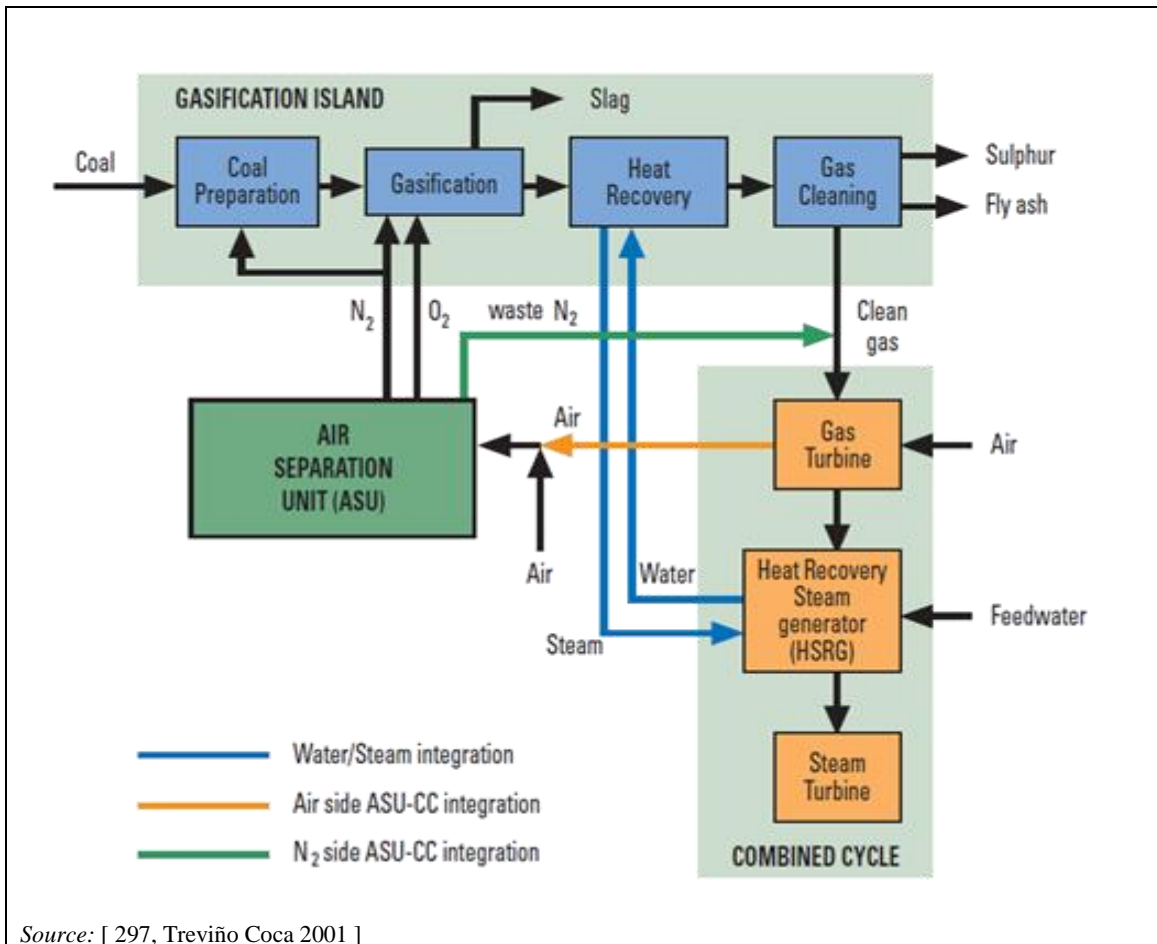

Figure 4.1: Block diagram and integration options for an IGCC plant

The production of methane from the methanation reactions is favoured by higher pressures. Some actual data on the effect of pressure can be seen in Table 4.1, which shows the syngas compositions from several fixed-bed and fluidised bed gasifiers.

Table 4.1: Syngas compositions from fluidised bed and fixed-bed gasifiers (typical bituminous coal)

Parameter	Units	Gasifier type				
		Fixed dry ash	Fixed slagging	Fixed slagging	Fluidised KRW	Fluidised synthane
Pressure	barg	27.5	27.5	69	31	69
H ₂	(mol % clean dry basis)	40	28	25	34	32
CO	(mol % clean dry basis)	17	59	59	45	13
CH ₄	(mol % clean dry basis)	9	7	10	7	15
CO ₂	(mol % clean dry basis)	32	3	3	12	36
N ₂ + Ar	(mol % clean dry basis)	2	3	3	2	4

In single-stage entrained-flow gasifiers (see the example in Figure 4.2), the fine coal particulates react with the concurrently flowing steam and oxygen. The residence time is very short (a few seconds) and the operating temperature is above the ash fusion temperature, ensuring the destruction of tars and oils and achieving a high carbon conversion rate. The methane content is very low and the raw gas has a high sensible heat content. The various designs of entrained-flow gasifiers differ in their feed systems (dry pneumatic or coal/water slurries), vessel containment for the hot flows (refractory or membrane water wall), and configurations for recovery of the sensible heat from the raw gas.

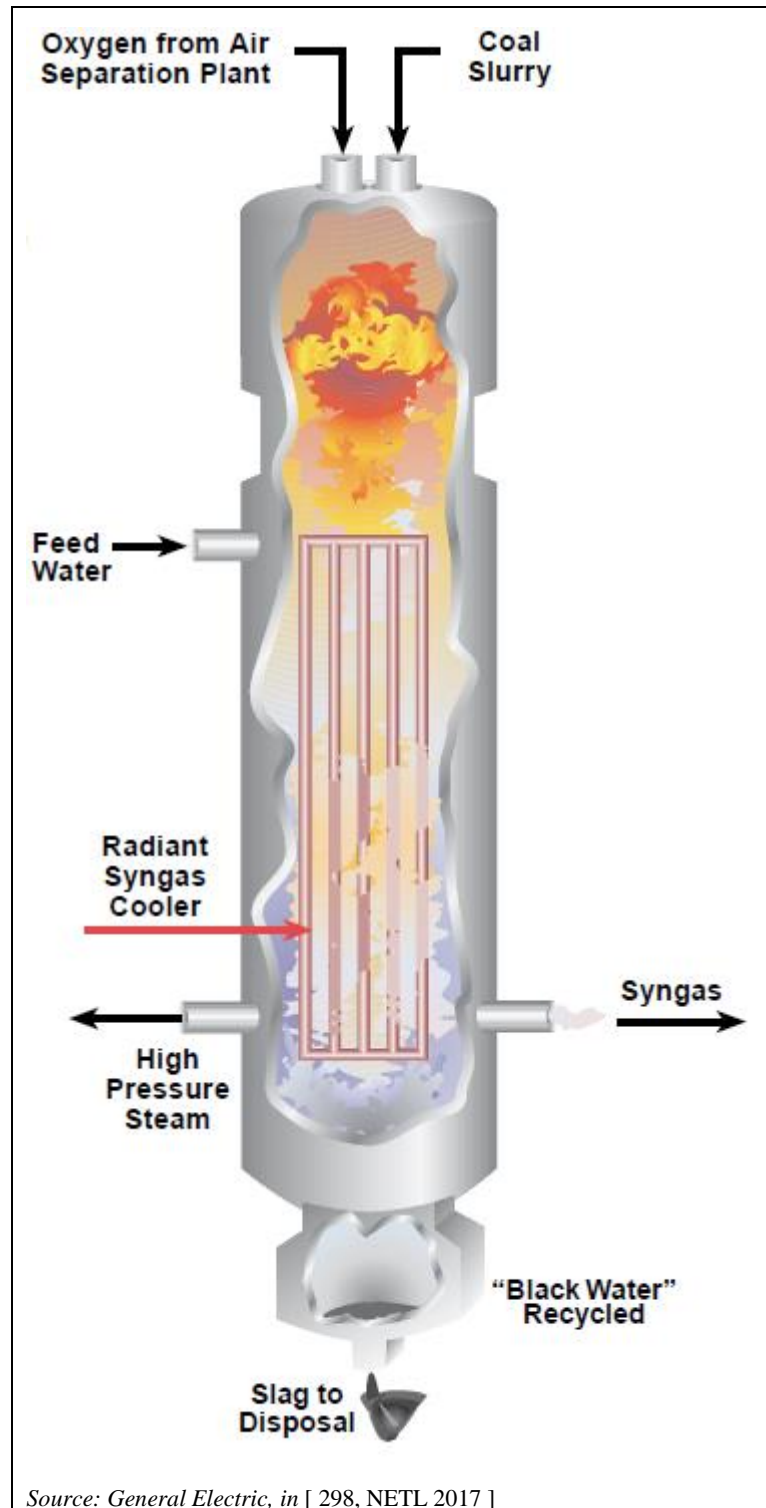

Figure 4.2: General Electric single-stage entrained-flow gasifier

Some gasifier designs use two stages to improve the gasifier cold gas efficiency, to reduce the sensible heat in the raw gas, and to lower the oxygen requirements. In a two-stage entrained-flow gasifier, the coal fed to the second stage reduces the outlet temperature and produces some methane which survives in the syngas. The methane content will increase if a higher proportion of the coal is fed to the second stage. The typical syngas compositions from several entrained-flow gasification processes are shown in Table 4.2.

Table 4.2: Syngas compositions from entrained-flow coal gasification processes (typical bituminous coal)

Parameter	Units	Gasifier stages / feed				
		Single / Slurry	Single / Dry	Two / Slurry	Two / Slurry with more feed to 2 nd stage	Two / Dry
Pressure	barg	69	34	31	31	69
H ₂	(mol % clean dry basis)	37	28	33	30	32
CO	(mol % clean dry basis)	47	64	54	49	29
CH ₄	(mol % clean dry basis)	< 0.1	< 0.1	1	6	15
CO ₂	(mol % clean dry basis)	14	2	10	12	22
N ₂ + Ar	(mol % clean dry basis)	2	6	2	3	2

Entrained-flow gasifiers are used in the majority of commercial-sized IGCC projects. A major advantage of the high-temperature entrained-flow gasifiers is that they avoid tar formation and its attendant problems. Their syngas has little methane and is very suitable for hydrogen and synthesis gas products. The high reaction rate also allows single-stage gasifiers to be built with large gas outputs sufficient to fuel large commercial gas turbines.

IGCC plants based on petroleum residuals all use entrained-flow gasifiers. There are also over a hundred of these heavy oil gasifiers in operation worldwide for the manufacture of ammonia, methanol, hydrogen, other chemicals and power.

Two air-blown gasification technologies are in construction at the Mississippi Power (Southern Company subsidiary) nominal 585 MW_e IGCC + CCS project in Kemper County, Mississippi and a two-stage entrained-flow gasifier is in commercial operation at the Nakoso 250 MW_e Clean Coal Power R&D plant, in Japan. Representative gas compositions from these two air-blown processes are shown in Table 4.3.

Table 4.3: Syngas compositions for air-blown KBR and MHI gasification processes

Parameter	Unit	Gasifier	
		KBR Transport	MHI
Pressure	barg	34	51
Coal	(mol % clean dry basis)	PRB sub-bituminous	Shenhua China
H ₂	(mol % clean dry basis)	12	10
CO	(mol % clean dry basis)	24	31.9
CH ₄	(mol % clean dry basis)	2.5	1.4
CO ₂	(mol % clean dry basis)	7	2.7
N ₂ + Ar	(mol % clean dry basis)	54.5	54

Figure 4.3 summarises the composition of the syngas, i.e. content in CO, CO₂, H₂O, CH₄, H₂S, (excluding nitrogen and using Illinois coal) as a function of the O₂ to coal feed ratio.

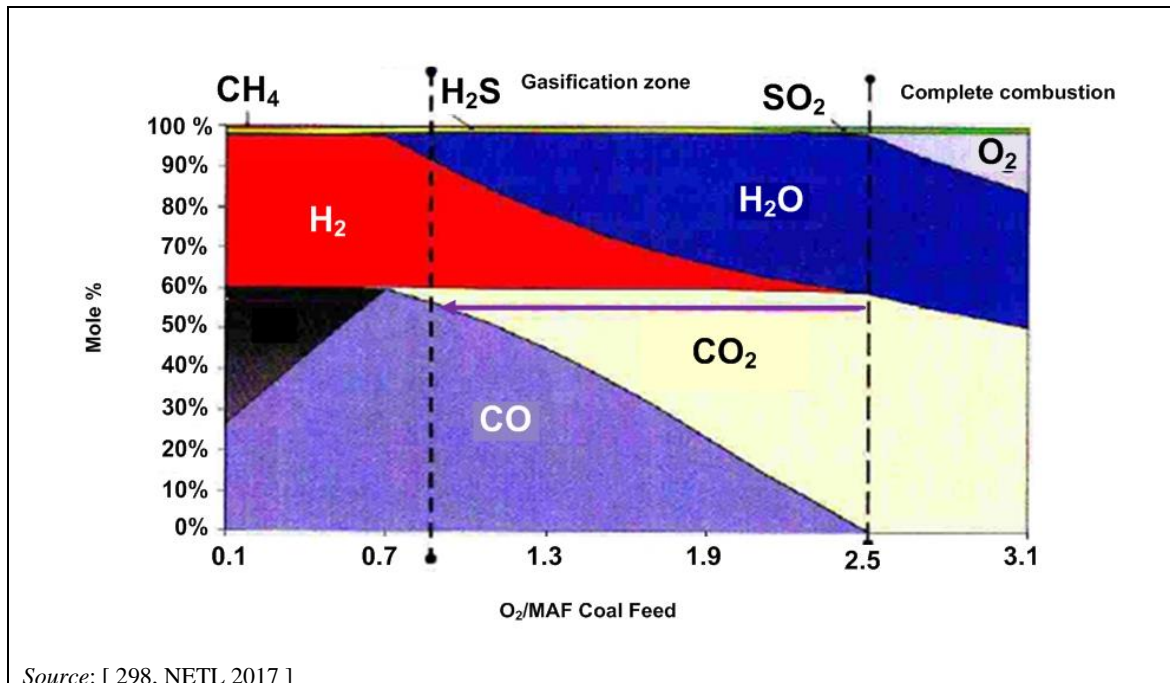

Figure 4.3: Syngas composition as a function of the O₂ to coal feed ratio

Along with gasification, the power plant is a combined-cycle gas turbine and may be integrated with a high-pressure air separation unit (ASU) for nitrogen and high-purity oxygen supply. The air used by the ASU is supplied by the gas turbine compressor or not, depending on the level of integration of the IGCC; the produced nitrogen not used in the gasification process or in auxiliary systems may be injected into the combustion chamber to reduce NO_x emissions.

Integration concept

There are many variations in the basic layout of an IGCC plant, with the level of integration between the units being the fundamental aspect of the design (see also Figure 4.1):

- In most plants, the combined cycle and the gasification island water/steam systems are fully integrated. The gasification island feed water comes from the combined-cycle heat recovery steam generator (HRSG). The steam produced in the gasifier waste heat boiler is exported to the HRSG for superheating and then expanded in the steam turbine, generating additional electricity. Part of the steam produced in the gasifier and in the HRSG is used for internal consumption, e.g. to saturate syngas with water, in order to reduce NO_x formation in the gas turbine combustion chamber (also increasing the mass flow evolving in the gas turbine and thus the power output), as an alternative method for nitrogen dilution.
- Nitrogen-side integration of the ASU and the combined cycle. The residual nitrogen, a by-product of the ASU, is compressed and mixed with the syngas to reduce NO_x emissions and to increase the capacity of the gas turbine.
- Air-side integration of the ASU and the combined cycle. The compressed air required by the ASU is partially or totally extracted from the gas turbine compressor. In this case it is necessary to use all of the nitrogen in order to maintain the full capacity of the gas turbine. If nitrogen dilution is desirable despite the ASU having its own feed air compressor, some modifications to the gas turbine may be required (e.g. extra compressor blade rows).

- Integration of the gasification island and the combined-cycle power production. Part of the power production from the combined cycle is used to satisfy the power requirement of the gasification island.

Various suppliers propose commercial IGCC solutions, and between 10 and 15 IGCC plants were in operation worldwide in 2012.

A few examples of coal IGCC plants are presented in the block diagrams below.

Polk IGCC Power Plant (Florida, US), owned by the Tampa Electric Company (TEC), has been operating since 1996, and has a net capacity of 250 MW. The block diagram of the process is shown in Figure 4.4.

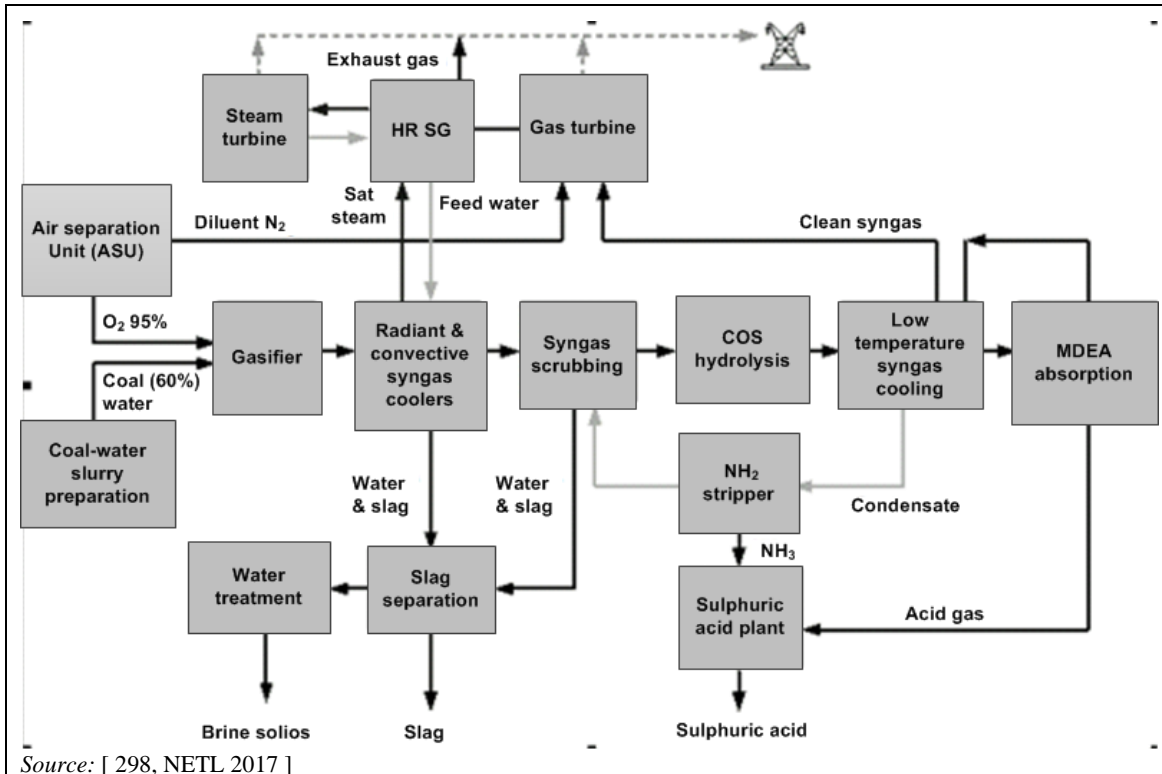

Figure 4.4: Block diagram of the Tampa IGCC plant process

The block diagram of the Nuon (formerly SEP/Demkolec) IGCC plant process in the Netherlands is shown in Figure 4.5.

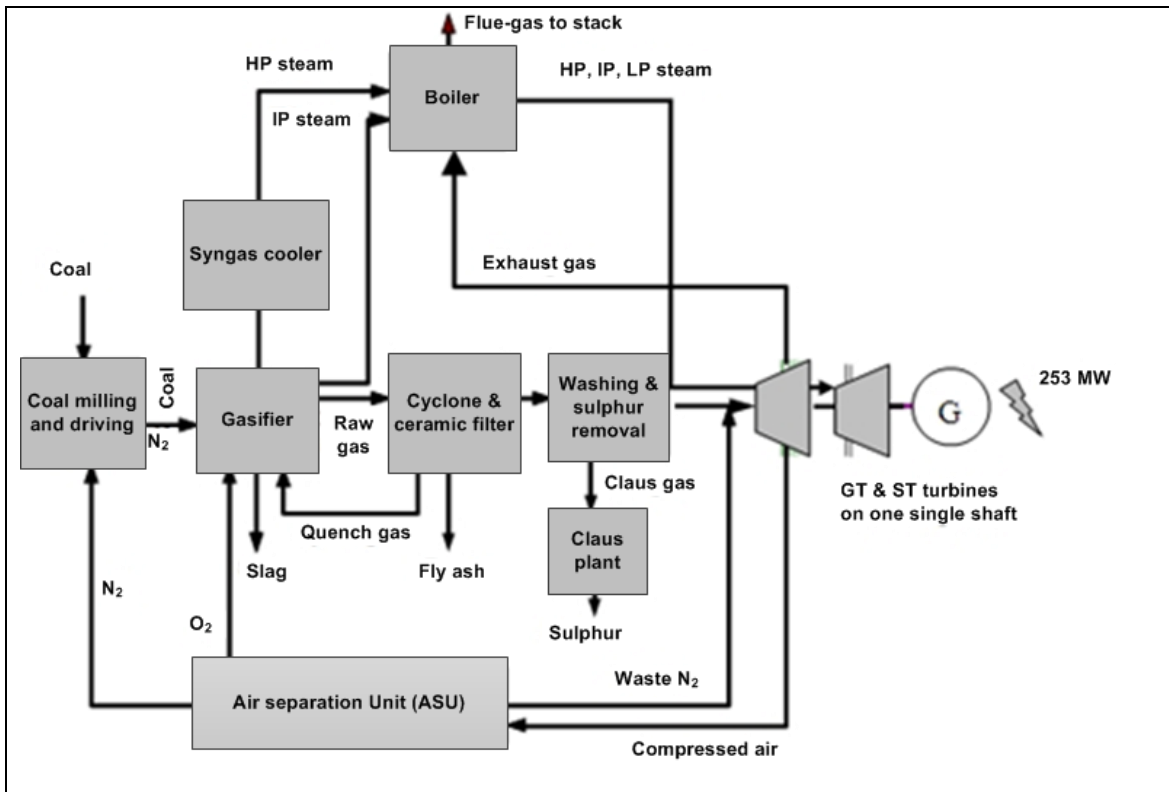
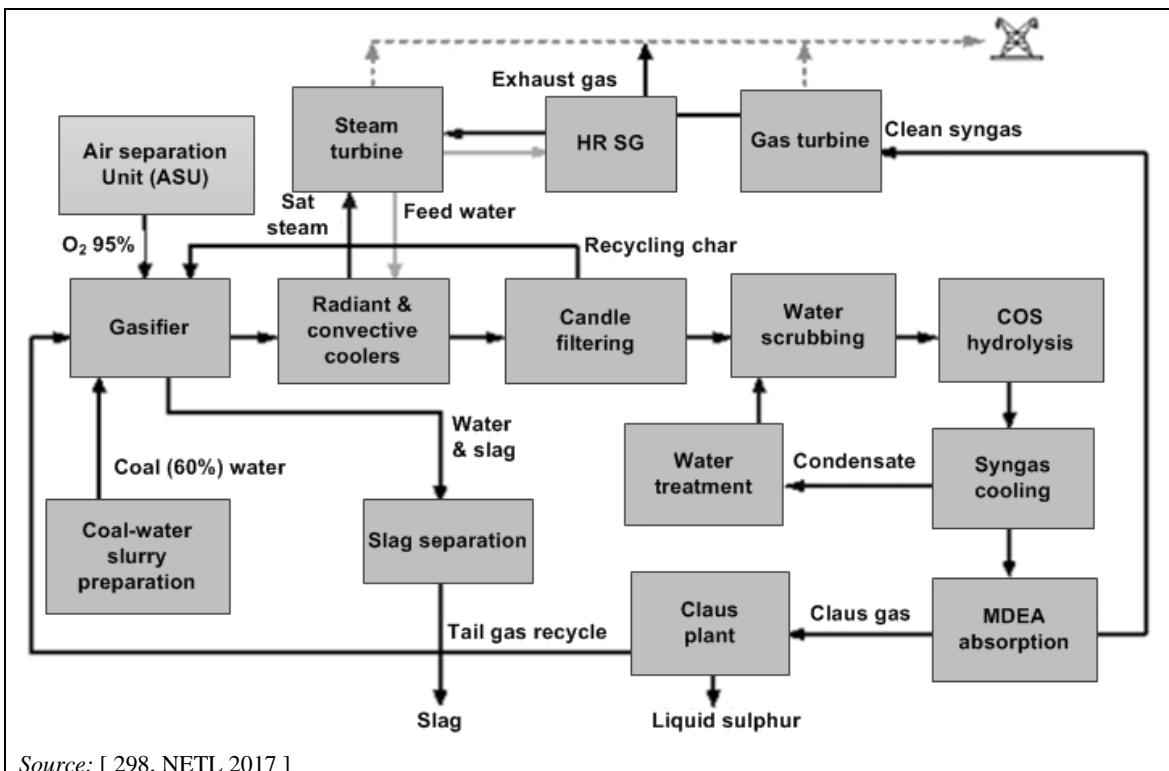

Figure 4.5: Block diagram of the Nuon IGCC plant process

The block diagram of the Wabash River IGCC repowering project (USA) is shown in Figure 4.6.



Source: [298, NETL 2017]

Figure 4.6: Block diagram of the Wabash River IGCC repowering project

The block diagram of the pressurised entrained-flow gasifier, dry-fed ELCOGAS IGCC plant in Puertollano, Spain is shown in Figure 4.7.

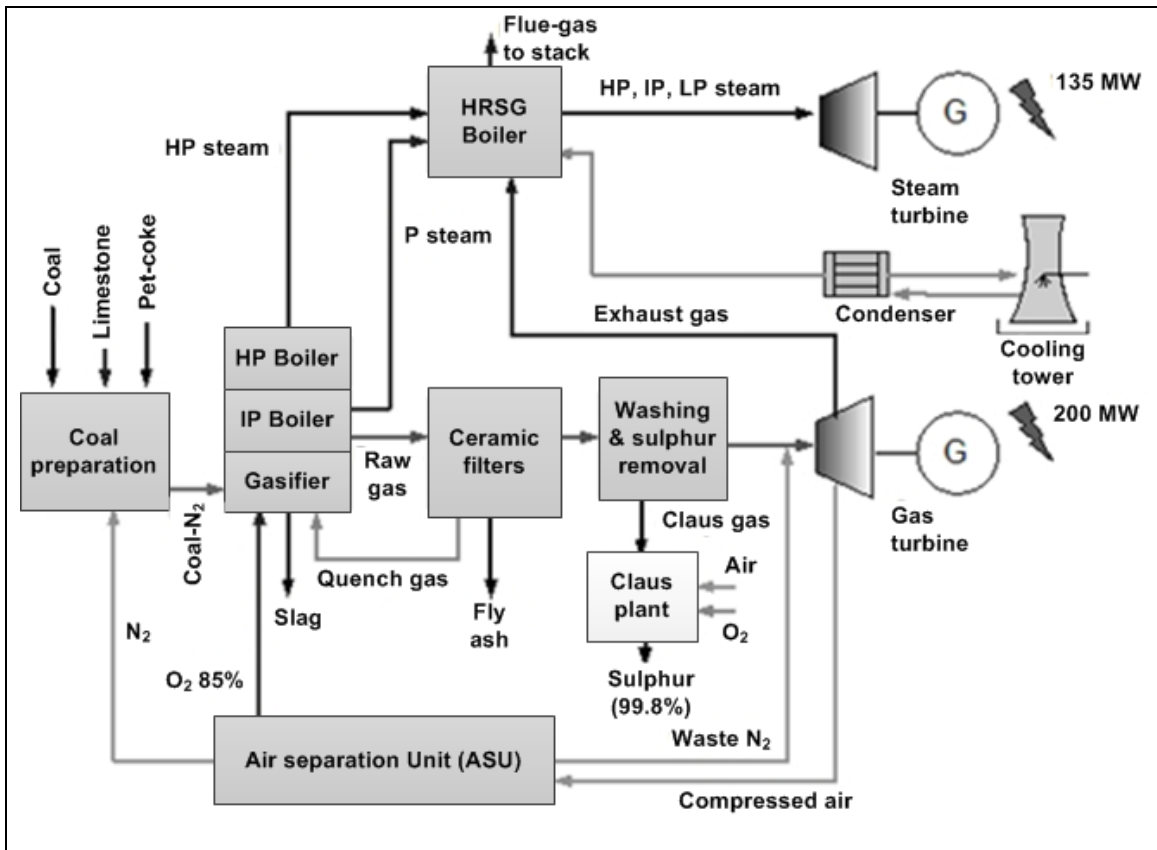

Figure 4.7: Block diagram of the ELCOGAS IGCC plant process

IGCC plants based on fossil fuels other than coal

In Europe and Asia, most of the refinery IGCC plants are based on various refinery heavy oil streams (e.g. vacuum resin, deasphalter bottoms, visbreaker residue), while in the US, petroleum coke is more often used as the feedstock for IGCC plants.

Heavy oil gasification

Heavy oil gasification technology has been widely commercially available since the 1950s with more than 200 units licensed worldwide. Most of the applications prior to 1990 were to supply syngas for chemical manufacture or hydrogen to refineries. The IGCC application only appeared in the 1990s. Available gasifiers are based on single-fuel injector, downflow, oxygen-blown, refractory-lined, entrained-flow reactors:

- Three plants in Italy entered full commercial service in 2001. These are an Isab Energy S.r.l. 510 MW plant in Sicily, an Api Energia 260 MW plant in Falconara and a Sarlux 550 MW plant in Sardinia. In 2000, three additional heavy oil gasification plants were commissioned (one in the US and two in Singapore). In 2003, a single-train 342 MW IGCC plant entered commercial service at the Negishi refinery in Japan. Several other gasifiers operating on heavy oil/pitch have also been supplied to China and India in the past decade, most of them being for ammonia, chemicals and fuel gas, not for IGCC.
- Pernis (the Netherlands) and ENI, Sannazzaro-Ferrera E. (Italy) are other examples of IGCC plants gasifying heavy oil in refineries.

Petroleum coke gasification

The main gasification technologies are able to use pet coke as fuel:

- Coffeyville Resources (US) uses pet coke to produce hydrogen for ammonia manufacture; some of the captured CO₂ is used to form urea through reaction with some of the produced ammonia, and it also provides CO₂ for enhanced oil recovery (EOR). Also, the Tampa IGCC plant in Polk County, Florida usually runs on a mixture of 55 % petroleum coke and 45 % coal in order to reduce feedstock prices.
- The ELCOGAS IGCC plant runs on a fifty-fifty mixture of petroleum coke and coal.
- Since the conclusion of the DOE demonstration programme in January 2000, the Wabash River plant has been running on 100 % petroleum coke.

4.1.2 Biomass gasifiers

The incentive for biomass gasification is generally attributed to the potential for a much higher power generation efficiency with a biomass IGCC, or with the multi-fuel firing of biomass gas in existing boilers, than can be accomplished with direct combustion boilers and steam turbines in the smaller size range appropriate for dedicated biomass projects. Because of the nature of biomass, and the economics and logistics of its gathering and supply, such projects are generally considered in the much smaller 10–190 MW_{th} size range than the larger 500 MW_{th} coal-based IGCC plants or other coal-fired units, so the main challenge for potential projects is the diseconomy of scale. Because of the heightened concern over global warming, there is an increased interest in renewable energy projects, including those associated with biomass.

The availability of biomass is a limiting factor for the commercialisation of biomass gasification. However, the occurrence of tars in syngas is also a major problem that has to be overcome in striving to commercialise biomass gasification processes for various purposes, and efforts by vendors and research organisations to alleviate this problem are ongoing. The use of entrained-flow gasifiers may eliminate tar problems, but these are mainly suited to large industrial-scale gasification (> 100 MW_{th}) and are therefore generally not relevant for most biomass gasification applications [293, Brandin et al. 2011]. However, in coal-based IGCC plants (Nuon Buggenum, the Netherlands and ELCOGAS Puertollano, Spain), the viability of biomass co-gasification in small relative percentages, which still represents considerable biomass power (5–30 % of biomass as fuel represents up to 30–200 MW_{th}), has been demonstrated.

There are two main strategies for dealing with the tar once it is present in the syngas: removal or *in situ* conversion. Removal includes wet/oil scrubbing systems; partial oxidation and catalytic tar cracking are examples of *in situ* conversion methods [293, Brandin et al. 2011]. Another solution for conversion is to keep the gas above the tar dew point and use the tar as a part of the gas to be combusted in the boiler, which increases the energy efficiency by 5–10 %. [328, Blomberg et al. 2012]

Fixed-bed (updraught and downdraught) and fluidised bed gasifiers are the three primary varieties of biomass gasification technologies; they are mainly applicable on a small or medium scale.

Updraught and downdraught fixed-bed designs are less complex than a fluidised bed, but generate lower energy value syngas and are most suitable for small-scale biomass gasification (in the range of a few hundred kW_{th}). The market attractiveness of fixed-bed biomass gasifiers of a scale relevant for this document (> 20 MW_{th} rated input) is currently very limited.

Most of the larger biomass gasification projects in both the US and Europe are based on fluidised bed gasification under either atmospheric or pressurised conditions.

Circulating and bubbling fluidised bed gasifiers

Fluidised bed gasifiers may be circulating (CFB) or bubbling (BFB), and are most useful for a wide range of fuels, mainly because the feeding size requirement is not as strict as it is in entrained-flow gasifiers. CFB/BFB fluidised bed gasifiers produce higher fuel value syngas and accept a wider range of feedstocks, compared to updraught and downdraught fixed-bed gasifiers. They are well suited for continuous operation and scalable to a wide range of sizes, allowing for large-scale industrial plants. Hence, CFB/BFB fluidised bed gasifiers are state-of-the-art technology for biomass gasification at the scale covered in this document ($> 20 \text{ MW}_{\text{th}}$).

CFB/BFB fluidised bed gasifiers may be air-blown, oxygen-blown and/or steam-blown and may be pressurised or operate at atmospheric pressure. Steam and/or oxygen or air are introduced below the fluidised bed, which is suspended by the fluidisation gases. In a BFB gasifier, the fuel is fed into the dense bed, flows upwards through the reactor tower, and remains suspended in this stream while gasification takes place. Moderate-temperature syngas exits the top of the reactor, while dry (unmelted) ash is removed at the bottom. Issues to be addressed in the design include the quality and replenishment of the heat transfer medium and erosion of the reactors (Pytlar, 2010).

The circulating fluidised bed (CFB) gasifier (see Figure 4.8) consists of a reactor in which the air-blown fluidised gasification takes place, a cyclone to separate the circulating bed material from the gas, and a return pipe for returning the circulating material to the bottom of the gasifier.

Ranges of syngas compositions from CFB and BFB biomass gasifiers are shown in Table 4.4.

Table 4.4: Typical syngas compositions for BFB and CFB biomass gasifiers (range)

Parameter	Unit	BFB gasifier	CFB gasifier
Pressure	barg *	1–35	9–108
Feedstock	(mol % clean dry basis)	Various	Various
H ₂	(mol % clean dry basis)	6–38	11–32
CO	(mol % clean dry basis)	14–40	14–33
CH ₄	(mol % clean dry basis)	< 1–5	3–8
CO ₂	(mol % clean dry basis)	15–17	11–34
N ₂	(mol % clean dry basis)	3–58	3–47
* In 2013, highest operating pressures were approximately 20 barg [89, EPPSA 2013]. Sources: [294, Ciferno and Marano 2002] [295, E4Tech 2009]			

The operating temperature area (window) of a fluidised bed gasifier is determined by the ash melting temperature and by the temperature needed for the gasification reactions. The possibility to lower the gasification temperature is limited because it can lead to incomplete gasification and increase the tar compounds in the syngas. Gas produced in high-temperature operation typically contains less tars than gas produced at lower temperatures. This is because high temperatures favour tar-cracking reactions. Tar is harmful to scrubbers when it condenses there. Tar can generate coke in the filters if high-temperature dust removal is adopted. Selection of the right method to handle the tar-containing gas is essential.

The technical operating temperature window of biofuel gasification in CFB/BFB gasifiers is relatively limited, and it can be a big economic drawback in new power plant investments, compared to the conventional power plant technology which is more flexible in terms of the diversity of fuels that can be used.

Biomass gasification at atmospheric pressure

Air-blown fluidised bed gasification units operating at atmospheric pressure and low temperature were originally developed for woody biomass feedstocks, but they can also be utilised with other types of biomass and with a wide range of waste-derived fuels.

The atmospheric CFB gasification system (see Figure 4.8) is relatively simple. All the gasifier components are entirely refractory-lined. From the cyclone, the hot product gas flows into an air preheater located below the cyclone. The units are usually close-coupled to a boiler with no gas clean-up other than the primary cyclone of the CFB, so the tars and any entrained char are burnt together with the fuel gas in the boiler. The units generally rely on the boilers for the environmental clean-up of the combustion gases. Fuel drying is often necessary to achieve the required flame properties. Units in the 10–190 MW_{th} size range are feasible.

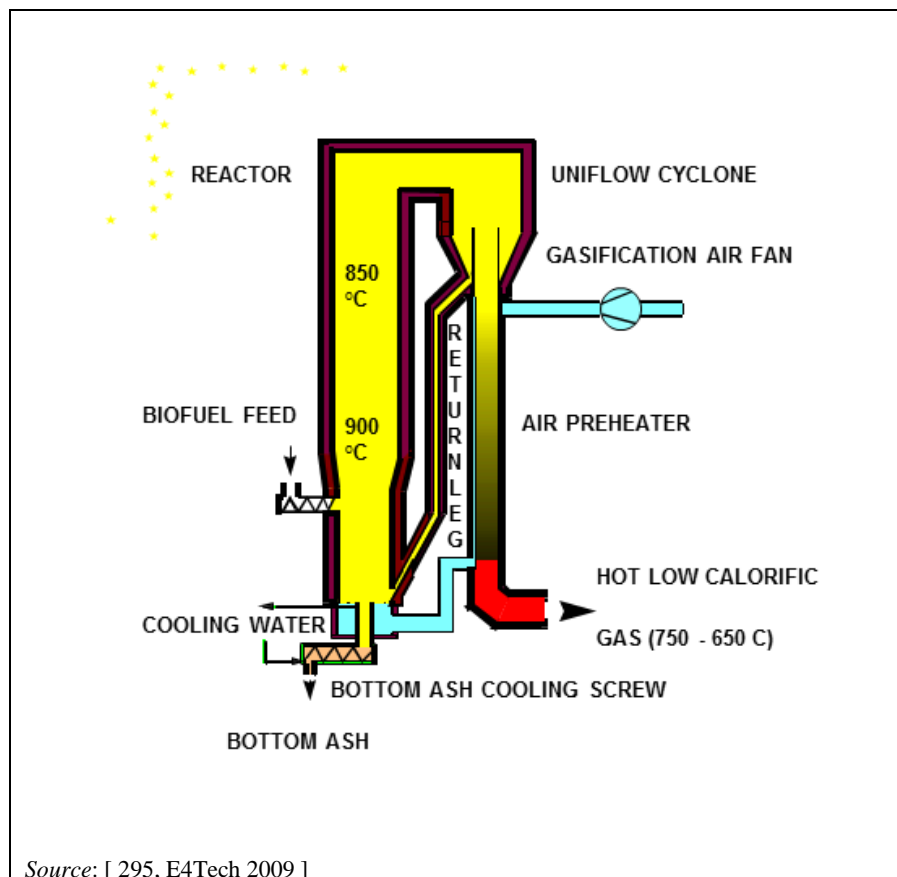

Figure 4.8: Foster and Wheeler atmospheric CFB gasifier

There are several biomass gasification projects in Europe in which the syngas from atmospheric fluidised bed gasification is co-fired in existing boilers. This approach has the advantage of avoiding the need to build a completely dedicated biomass power plant. One of the plants with more experience of this system is the Kymijärvi plant in Lahti, Finland.

Atmospheric pressure CFB gasifiers have also found application in waste gasification projects located adjacent to coal-fired boilers, with the gas being fed into the boiler firebox.

Pressurised biomass gasification

Pressurised fluidised bed gasification (see Figure 4.9) is often used for biomass IGCC. A demonstration plant at Varnamo, Sweden (6 MW_e + 9 MW_{th} for district heating) was operated by Sydkraft between 1993 and 1999. A combined heat and power biomass gasification plant (I/S Skive Fjernvarme in Denmark) has also started operating in 2007.

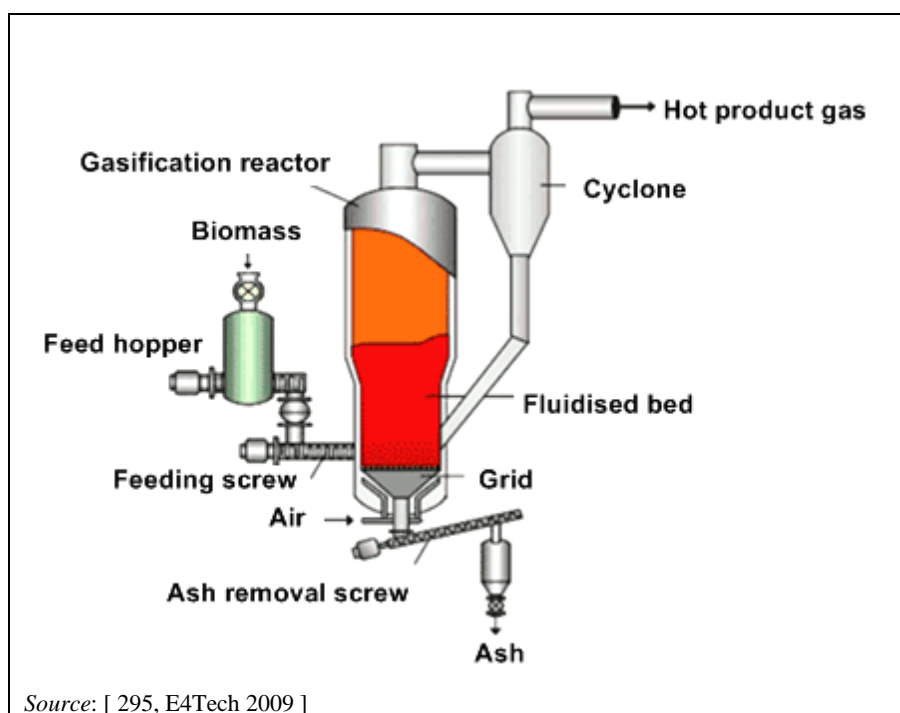

Figure 4.9: ANDRITZ Carbona air-blown pressurised BFB gasifier

Co-gasification of biomass in IGCC plants and coal gasifiers

Substantial amounts of biomass and wastes (5–25 t/h) can be added to the feed in coal gasifiers without compromising the operation or quality of the slag, as long as the percentage of biomass in the fuel mix is limited. These limits are mainly determined by the syngas clean-up systems and the specific composition of biomass used. Some biomass ashes are high in alkalis, such as sodium and potassium, which above a certain percentage of biomass usage could increase fouling and could negatively impact the slag leaching properties.

An example of a co-gasification plant is the Nuon Buggenum gasifier, which can now handle up to 15 % (LHV basis) clean white wood without significant modification; 30 % (LHV basis) biomass has been permitted and up to 70 % (LHV basis) has been tested with refined biomass. The ELCOGAS IGCC plant has also demonstrated viability for feed with 2–10 % biomass (2–10 t/h), without modification of the preinstalled equipment.

Biomass gasification connected to coal boilers

Fluidised bed biomass gasifiers linked to combustion processes can be divided into two main categories: CFB/BFB gasifiers directly connected to a boiler and CFB/BFB gasifiers with gas filtration/cleaning.

The filtered syngas can be used for co-combustion in PC boilers in the same way as unfiltered biomass-derived gas. In addition, clean gas can be combusted alone in large-scale boilers designed for gaseous fuels.

The clean gas can also be used for other applications, such as SNG (synthetic natural gas) production, and hence the CFB/BFB gasifiers with gas filtration/cleaning can be further classified into two sub-categories, depending on the main product application:

- those connected to a boiler/gas engine (for power production);
- those for SNG production.

SNG can be used for example in the natural gas grid or for transport purposes, but these applications are not included in this document. However, SNG production plants can also

include the possibility for some of the SNG to be used in a gas engine or gas turbine; this application is covered by this document.

Figure 4.10 illustrates different gasification and gas cleaning options.

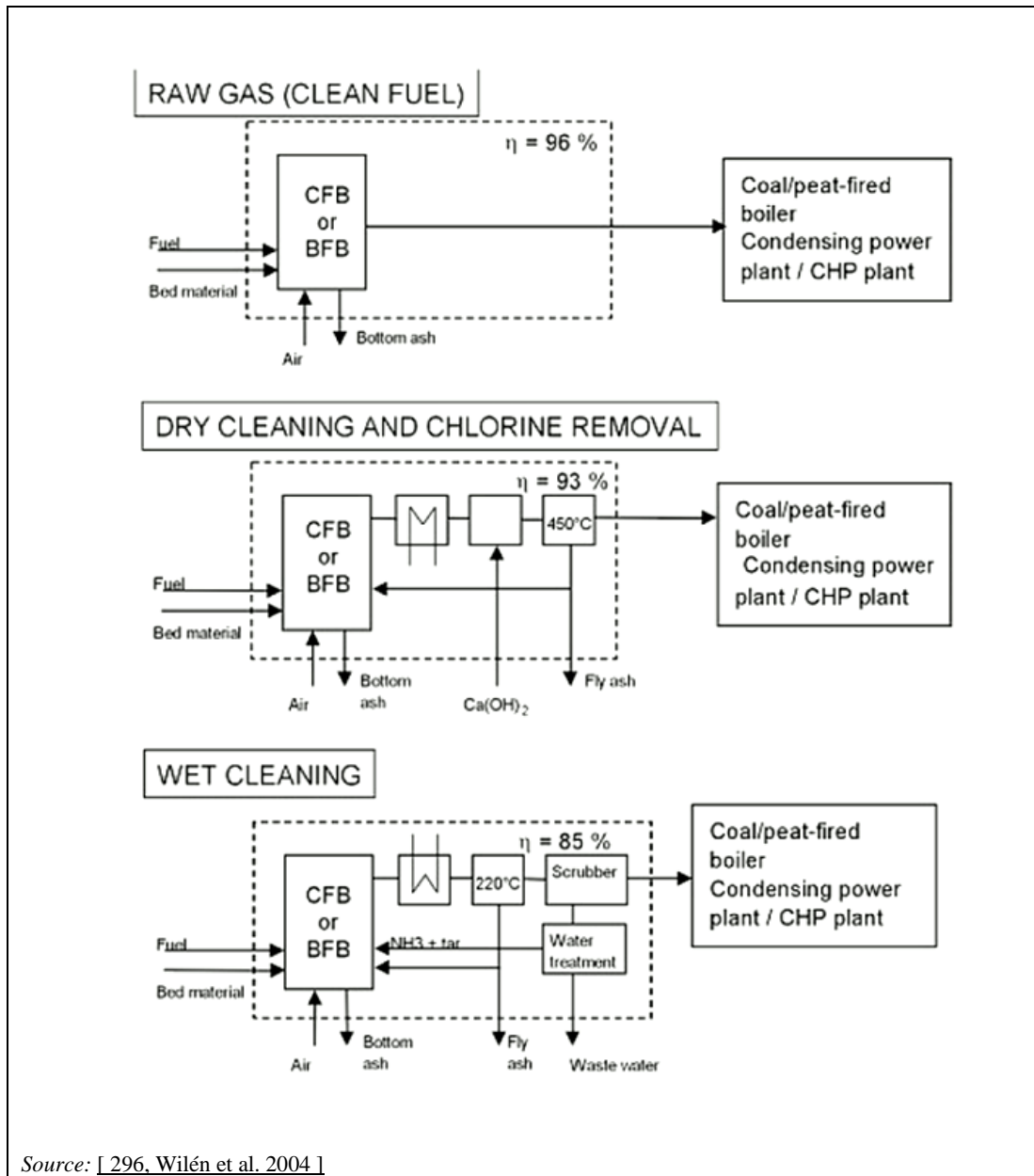

Figure 4.10: Different principal options for CFB/BFB gasifier connections to boilers

4.1.3 Plasma gasification of waste material

In a plasma gasifier, a high-voltage current is fed to a torch, creating a high-temperature arc. The inorganic residue is retrieved as a glass-like substance. This gasification method operates at very high temperatures and can process any kind of waste.

Several organisations have developed plasma gasification units for the destruction of several types of waste, including hospital wastes, industrial organic chloride and nitrogenous wastes, and municipal (MSW) solid waste.

4.2 Current emission and consumption levels

The main environmental issues include:

- waste water release (organic content, cyanides, sulphides, ammonia, heavy metals);
- waste and by-product generation: slag, bottom/fly ash, sulphur/sulphuric acid from the desulphurisation stage, used/saturated catalyst;
- consumption of water, chemicals (solvent) and energy;
- fuel handling and pretreatment (diffuse emissions such as dust, VOCs);
- should the process be integrated with combustion: overall influence on energy efficiency and on emissions to air/water, and synergies/drawbacks induced by the integration.

Efficiency and emissions to air

Table 4.5, Table 4.6 and Table 4.7 contain information on efficiency and emissions of pollutants to air of European gasification plants (aggregation from submitted questionnaires and any additional information available).

Table 4.5: General information on efficiency and emissions to air of European IGCC plants

Gasifier / size	Feedstock	Syngas output efficiency (%)	Emissions to air (mg/Nm ³) – 15 % O ₂				
			NO _x	SO _x	Dust	CO	Hg
Buggenum (NL) / Entrained-flow / 585 MW _{th}	Coal (90 %) – Biomass pellets (10 %)	77.1	15	3		< 1	6E-06
ELCOGAS (ES) / Entrained-flow / 726 MW _{th}	Coal (50 %) – Pet coke (50 %)	74.1	45	15.5	0.4	2.8	1.8E-4
IGCC in refineries (ENI – ISAB – SARAS (IT)) / Entrained-flow / 2x272 – 2x663 – 3x530 MW _{th}	Heavy residual oils (95–100 %) – Heavy crude oil (0–5 %)	74.1–88.2	12.2–42	3–15.8	0.7–2.5	< 1–18	5E-3–5E-4

Source: [3, LCP TWG 2012]

Table 4.6: Comparison of the boiler gas emission measurement results from 100 % coal firing (1997) and from co-firing of gasifier gas and coal (2001)

Fuel composition:	MW _{th}	1997	2001
		Coal	350
Natural gas		350	293
Gasifier, total (1)		0	0
		ND	56
Flue-gas emissions			
O ₂ content (dry gas)	%	6	6.8
SO ₂ emission	mg/MJ	237	208
SO ₂ concentration	mg/Nm ³ (dry gas)	638	636
NO _x emission	mg/MJ	264	187
NO _x concentration	mg/Nm ³ (dry gas)	710	572
Dust emission	mg/MJ	11	7
Dust concentration	mg/Nm ³ (wet gas)	29	19
CO emission	mg/MJ	11	10
CO concentration	mg/Nm ³ (dry gas)	30	30
HCl concentration	mg/Nm ³ (dry gas)	0.4	34
HF concentration	mg/Nm ³ (dry gas)	2.4	7
PAH compounds, total	mg/Nm ³ (dry gas)	0.03	1
Polychlorinated benzenes	ng/Nm ³ (dry gas)	4	15
Polychlorinated biphenyls	ng/Nm ³ (dry gas)	2	16
Chlorophenols	ng/Nm ³ (dry gas)	50	20
PCDD total conc.	ng/Nm ³ (dry gas)	0.14	0.01
PCDF total conc.	ng/Nm ³ (dry gas)	0.19	0.001
PCDD/PCDF, I-TEQ	ng/Nm ³ (dry gas)	0.005	0.001
Total heavy metal concentrations in dry flue-gas			
Cr	mg/Nm ³	< 9	4
Ni	mg/Nm ³	< 9	3
Cd	mg/Nm ³	< 2	0.2
As	mg/Nm ³	< 4	2
Cu	mg/Nm ³	< 9	4
Zn	mg/Nm ³	< 35	16
Pb	mg/Nm ³	< 9	< 11
Hg	mg/Nm ³	< 0.6	1
Sum of heavy metals	mg/Nm ³	ND	59
⁽¹⁾ Wood: 29 MW; glulam wood: 8 MW; SRF: 16 MW; sewage sludge: 3 MW. NB: ND: Not determined. Sources: Air emissions, Kymijärvi I, Lahti, Finland: [296, Wilén et al. 2004]			

Table 4.7: Emission per MWh produced (heat and electricity) over 2007–2012

Emissions to air	Skive CHP plant, Denmark				
	2007/08	2008/09	2009/10	2010/11	2011/12
Emission per MWh produced					
CO ₂ (tonnes)	0.098	0.090	0.083	0.105	0.083
NO _x (kg)	0.516	0.540	0.538	0.549	0.559
SO ₂ (kg)	0.123	0.144	0.152	0.146	0.193
Source: [329, Skive Fjernvarme 2012]					

Gasification systems vs combustion

The following figures (Figure 4.11 to Figure 4.13) are based on data from the US NETL and compare emission levels from coal-fired IGCC plants and conventional pulverised coal (PC) power plants for three emission types, in order to assess gasifiers' environmental performance against combustion. The results are similar for other feedstocks and products when compared with combustion.

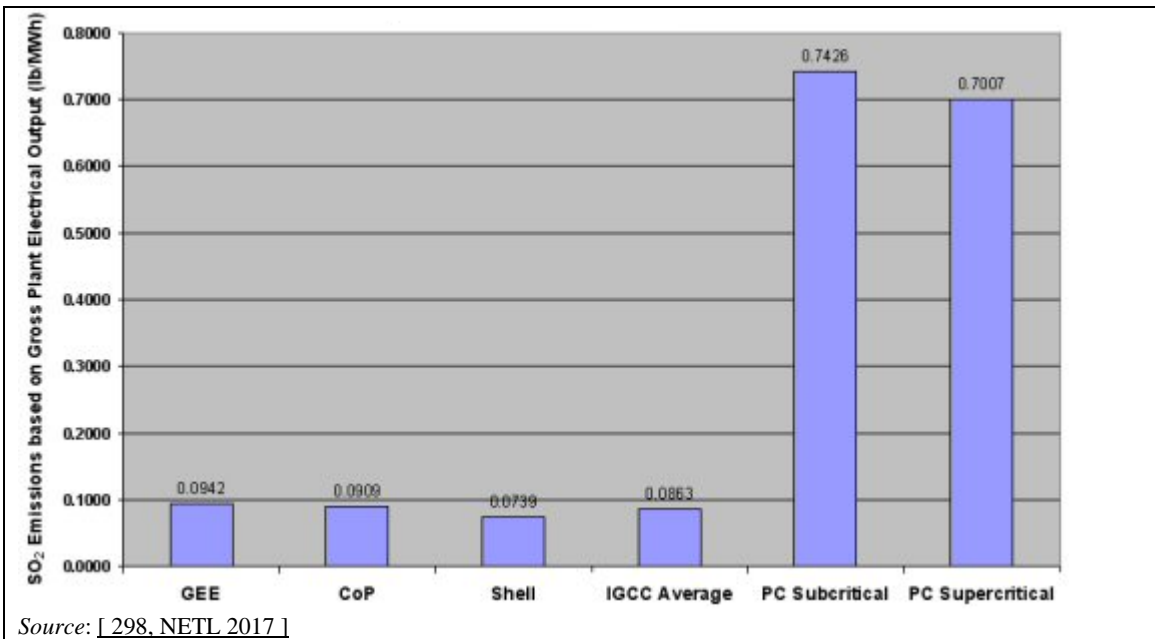

Figure 4.11: SO₂ emissions of currently feasible coal-to-electricity technology options without CO₂ capture

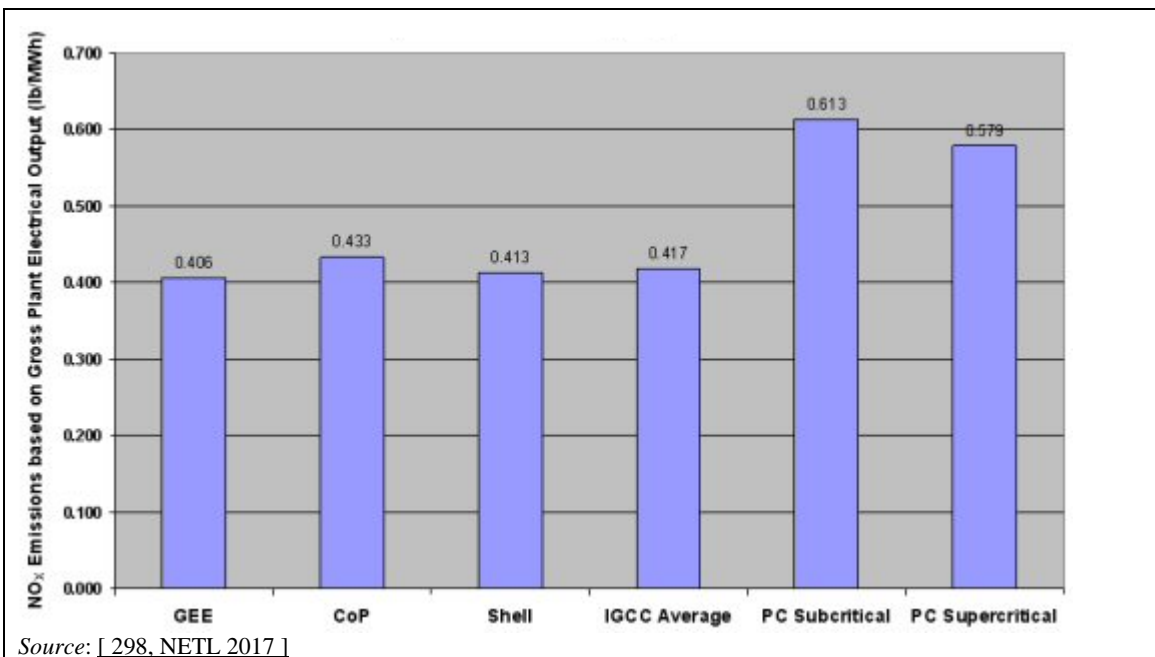

Figure 4.12: NO_x emissions of currently feasible coal-to-electricity technology options without CO₂ capture

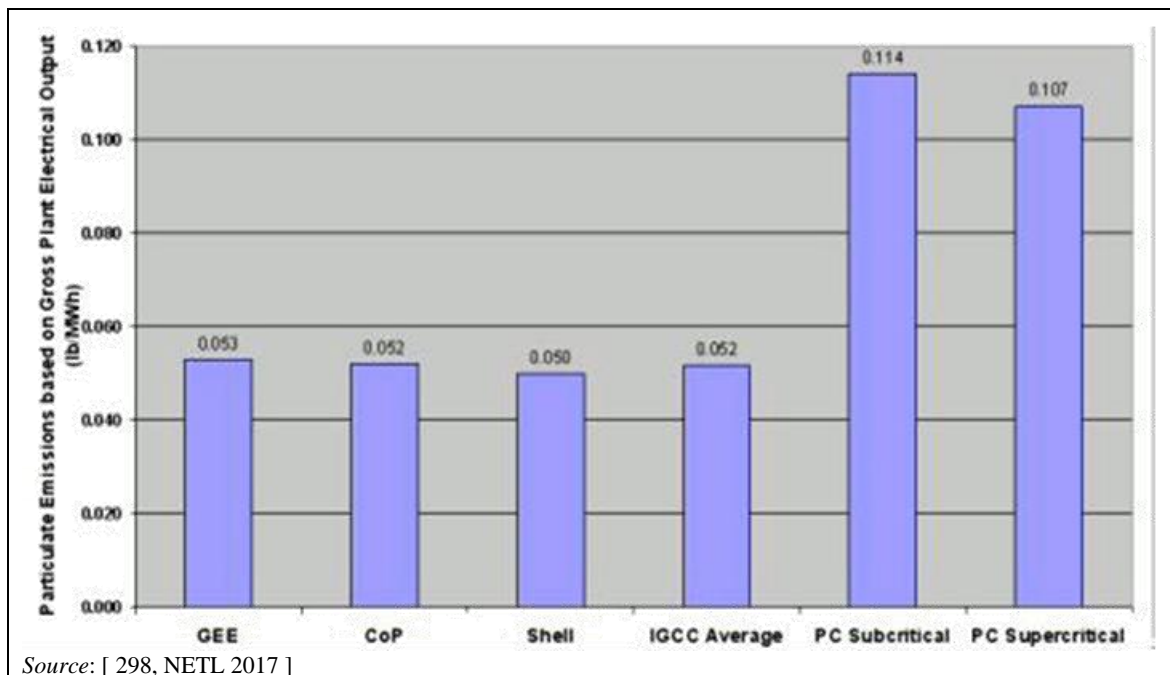

Figure 4.13: Particulate emissions of currently feasible coal-to-electricity technology options without CO₂ capture

Figure 4.11 shows that, other things being equal, the current IGCC technologies provide a SO₂ emissions reduction of nearly one order of magnitude compared with their PC counterparts.

Figure 4.12 shows that known methods for controlling NO_x formation keep these levels to a minimum in IGCC processes and result in NO_x emissions far below those associated with PC firing. During gasification, most of the nitrogen in the coal is converted into nitrogen gas (N₂). Small levels of ammonia (NH₃) and hydrogen cyanide (HCN) are produced, however, and can be removed during the syngas cleaning process.

Figure 4.13 shows that gasification offers two main advantages for dust control over combustion processes. First, gasification of coal provides the capability to remove most of the ash as slag or bottom ash for disposal or sale as a by-product. Secondly, since the syngas leaving the gasifier is much denser than combustion flue-gases, dust can be removed more easily with a proper gas cleaning system, to achieve a syngas quality similar or better than natural gas, as required by the final use, and allowing better optimisation of the environmental and efficiency performance.

Emissions to water

The water emissions correspond to the waste water released at specific release points and to the WWT facilities of only the gasification plant and its auxiliary systems. Examples of emission levels from the European IGCC plants gasifying coal are given in Table 4.8 and Table 4.9.

Table 4.8: Waste water emissions from the WAC Buggenum IGCC power plant, the Netherlands

Waste water release points	Water emission to municipal WWT	Water emission to river	Water emissions to on-site WWT for reuse	
Specification	Discharge without treatment	Regeneration water from demineralisation plant	No emissions (zero liquid discharge principle)	
Pollutant control	NA	NA	Dissolved gases, such as H ₂ S, NH ₃ and CO ₂ , need to be stripped out	
Special driving forces	NA	NA	Water is reused for moistening syngas – salts need to be removed	
Units				
Flow	m ³ /yr	NA	4E+04	Internal flow only
COD	mg/l kg/yr	400 1 800	NA	NA
TOC	mg/l kg/yr	NA	NA	200 9 000
TKN	mg/l kg/yr	370 16 650	NA	NA
Cl ⁻	mg/l kg/yr	NA	10 000 400 000	NA
F ⁻	mg/l kg/yr	NA	NA	50 2 250
SO ₄ ²⁻	mg/l kg/yr	NA	860 34 400	NA
N (total)	mg/l kg/yr	NA	NA	250 11 250
NB: NA: Not available Source: [3, LCP TWG 2012]				

Table 4.9: Waste water emissions from the ELCOGAS IGCC plant, Puertollano, Spain

Flow	Water emission to river	
	m ³ /yr	
Liquid effluents	Sulphide, S ²⁻	1.10E+06
	Fluoride, F ⁻	0.12 mg/l
	Cyanide, CN ⁻	9.9 mg/l
	Arsenic, As	0.15 mg/l
	Selenium, Se	0.02 mg/l
	Ammonia, NH ₄ ⁺	0.04 mg/l
	Total suspended solids, TSS	39 mg/l
	Chemical oxygen demand, COD	44 mg/l
	Sulphate, SO ₄ ²⁻	63 mg/l
	Cadmium, Cd	360 mg/l
	Mercury, Hg	0.01 mg/l
	Lead, Pb	0.01 mg/l
	Chrome, Cr	0.05 mg/l
	Copper, Cu	0.01 mg/l
Nickel, Ni	0.17 mg/l	
Zinc, Zn	0.27 mg/l	
Other parameters:	pH	7.981
NB: The plant is finishing the commissioning of a new liquid effluents treatment plant, under the concept of zero liquid discharge. Source: [3, LCP TWG 2012]		

4.2.1 Residues

Residues generated by gasification plants include fly ash, slag, elemental sulphur, waste from the gas cleaning, spent catalysts, sludge from waste water treatment, and scrap.

Examples of emission levels from European plants gasifying coal or biomass are given in Table 4.10 to

Table 4.12.

Table 4.10: Solid by-products, residues and waste from the WAC Buggenum IGCC power plant, the Netherlands

Solid by-products, residues and waste	Source	Generation during reference year (t)	Loss on ignition (%)	Final destination
Salt	WWT facilities	298	NA	Utilisation – others
Sludge	WWT facilities	110	NA	Temporary stockpile
Bottom ash	Gasification process	37 324	0.5	Utilisation – construction industry
Fly ash	Gasification process	10 647	0.5	Utilisation – construction industry
Sulphur	Syngas cleaning system	2 124	NA	Utilisation – others
NB: NA: Not available Source: [3, LCP TWG 2012]				

Table 4.11: Solid by-products, residues and waste from the ELCOGAS IGCC plant, Puertollano, Spain

Solid by-products, residues and waste	Source	Generation during reference year (t)	Unburnt carbon (wt-%)	Final destination
Fly ash	Fuel pretreatment facilities	14 320	1.75	Utilisation – construction industry
Vitrified slag	Fuel pretreatment facilities	58 207	3.6	Reclamation/ restoration of open mines, quarries and pits
Elemental sulphur	Fuel pretreatment facilities	16 927	NC	Utilisation – sulphuric acid and fertilisers industry
MDEA waste (from coal gas cleaning)	Fuel pretreatment facilities	215	NC	NA
Spent catalysts	Fuel pretreatment facilities	47	NC	NA
Contaminated ceramic material	Fuel pretreatment facilities	18	NC	NA
Sludge	WWT facility	15	NC	NA
NB: NA: Not available. NC: Not applicable. Source: [3, LCP TWG 2012]				

Table 4.12: Solid by-products, residues and waste from the Kymijärvi I plant, Lahti, Finland

Solid by-products, residues and waste	Source	Generation during reference year (t)	Unburnt carbon (wt-%)	Final destination
Bottom ash (gasifier)	The only direct solid output is gasifier bottom ash	2 810	NA	Landfilling
NB: NA: Not available. Source: [3, LCP TWG 2012]				

4.2.2 Consumption of water, chemicals and energy

Examples of consumption levels from European plants gasifying coal or biomass are given in Table 4.13 to Table 4.16.

Table 4.13: Consumption data from the WAC Buggenum IGCC power plant, the Netherlands

Consumption and output data			
Parameter		Unit	Quantity
Energy	Fuel energy input (as LHV)	MW _{th}	2 815 717
	Syngas energy output (as LHV)	MW _{th}	2 171 191
	Recovered heat from the gasification	MW _{th}	418 748
Water:	Total inlet flow	m ³ /yr	9.00E+04
	Process water consumption	m ³ /yr	9.00E+04
	Water for cooling system	m ³ /yr	2.79E+08
NB: Zero liquid discharge in the permit, most water (except cooling water) is recycled Source: [3, LCP TWG 2012]			

Table 4.14: Consumption data from the ELCOGAS IGCC plant, Puertollano, Spain

Consumption and output data			
Parameter		Unit	Quantity
Energy	Fuel energy input (as LHV)	MW _{th}	3.28E+06
	Syngas energy output (as LHV)	MW _{th}	2.43E+06
	Recovered heat from the gasification	MW _{th}	560 000
Water:	Total inlet flow	m ³ /yr	5.74E+05
	Process water	m ³ /yr	2.88E+05
	Water for steam system	m ³ /yr	2.35E+05
	Water for cooling system	m ³ /yr	1.82E+06
NB: Consumed water streams are lower than the inlet flow, as more raw water is needed to produce demineralised water. Source: [3, LCP TWG 2012]			

Table 4.15: Consumption data from the Kymijärvi I plant, Lahti, Finland

Consumption and output data			
Parameter		Unit	Quantity
Energy	Fuel energy input (as LHV)	MW _{th}	3.20E+05
	Syngas energy output (as LHV)	MW _{th}	3.13E+05
Water:	Total inlet flow	m ³ /yr	0
Source: [3, LCP TWG 2012]			

Table 4.16: Consumption levels per MWh produced (heat and electricity) over 2007–2012 for the Skive CHP plant

Consumption data					
Parameter	Quantity				
	2007/08	2008/09	2009/10	2010/11	2011/12
Value per MWh produced					
Water consumption (L)	236	279	146	176	201
Electricity consumption (kWh)	24	31	32	30	42
Source: [I/S Skive fjernvarme]					

4.2.3 Emissions to land/soil

Emissions to soil/land from gasification facilities may include unexpected incidents, such as leakages from waste water pipes.

4.3 Techniques to consider in the determination of BAT for gasification

4.3.1 Gasification integrated with the combustion process

This section presents relevant techniques to consider in the determination of BAT for gasification processes associated with combustion processes and with a minimum total rated thermal input of 20 MW. The gasification of refinery residues (e.g. heavy fuel oil) linked to combustion is not covered by this document but is addressed in the Mineral Oil and Gas Refineries BREF. However, as the techniques used are the same as those used when gasifying coal or other feedstocks in an integrated way with combustion processes, information provided by such plants gasifying refinery residues is used to further improve the description of the techniques to consider in the determination of BAT.

4.3.1.1 Prevention of emissions and efficient energy use in coal- and multi-fuel-based integrated gasification combined cycle (IGCC) plants

Description

Coal/multi-fuel gasification prior to combustion of the produced syngas in a combined-cycle gas turbine is an alternative to direct coal/multi-fuel combustion in a boiler and enables, by implementing a set of appropriate techniques to clean the produced syngas, reduce pollutant emissions and increase energy efficiency.

Technical description

All IGCC plants have demonstrated SO₂ and NO_x emissions comparable to or lower than those from a coal-fired pulverised combustion (PC) plant or a combined-cycle plant using natural gas (NGCC). Some pollutants, such as sulphur, can be turned into reusable by-products.

The plant is called *integrated* because (1) the syngas produced in the gasification section is used as fuel for the gas turbine in the combined cycle, and (2) steam produced by the syngas coolers in the gasification section is integrated into the normal steam cycle of the combined-cycle process. In a normal combined cycle, so-called waste heat from the gas turbine flue-gas is used in a heat recovery steam generator (HRSG) to make steam for the steam turbine cycle.

SO_x emissions to air

Sulphur compounds from the feedstock of a gasification process are generally removed from the syngas via an acid gas removal (AGR) process (e.g. including a (HCN)/COS hydrolysis reactor and the absorption of H₂S using a solvent such as MDEA or Sulfinol M Wash) as a concentrated hydrogen sulphide (H₂S) stream. Sulphur is then recovered as either liquid or solid elemental sulphur (e.g. through a Claus unit), or as sulphuric acid, depending on market demands. In the case of the Nuon plant (the Netherlands), the remaining H₂S levels are below 20 ppm by volume. In Nakoso (Japan), the H₂S-rich gas is burnt and the flue-gases scrubbed with limestone slurry to produce gypsum for sale, since there is very little market for elemental sulphur in Japan.

NO_x emissions to air

Due to the reducing atmosphere in which the gasification process takes place, the syngas does not contain NO_x, but ammonia (NH₃) in low proportions, which is eliminated during the gas cleaning process by water washing. In addition to dry low-NO_x burners, other techniques are used in the gas turbine, such as:

- syngas saturation with hot water/steam recovered with low-level heat or intermediate-pressure steam available in the plant (example plants: Nuon, ELCOGAS, and Wabash River, as well as Isab Energy S.r.l., Sarlux Sarroch, ENI, Sannazzaro-Ferrera E. (which are Italian IGCC plants gasifying refinery residues));

- syngas mixture with nitrogen from the ASU (Nuon and ELCOGAS);
- direct injection of some intermediate pressure steam into the gas turbine combustors (Wabash River);
- SCR (Nakoso, Japan).

As an alternative to dry low-NO_x burners, diffusion flame burners (should the H₂ content be > 15 %) or lean-premix burners in existing plants are used. Additionally, SCR may also be fitted to reduce NO_x emissions to air (example plants: Nakoso (Japan) and Isab Energy S.r.l. (Italy)).

Dust

Solid particulates are extracted from the syngas using filters and/or washing with water (e.g. at the Polk plant in the US) prior to gas combustion, and, as a result, dust emissions are irrelevant. The filters used are fly ash cyclones and/or candle filters to remove fly ash and unconverted carbon (example plants: Nuon and ELCOGAS). In the case of a low syngas temperature (1 100 °C), tars and ash with a high carbon content, generated in the raw syngas, are separated in cyclones and recirculated to the gasifier.

Gas coolers, cyclones and high-temperature filters are standard equipment in syngas treatment.

Cyclones generally remove particulates from 1 mm down to 5 µm in size and work with dry particulates. Cyclones can operate at actual gas temperatures (up to around 1 000 °C) to avoid chilling the gas [293, Brandin et al. 2011]. Cyclones can be used in series, in a multicyclone installation, to remove successively smaller particulates, but this is still not enough to meet gas turbine specifications. [299, Pytlar 2010]

A high-temperature ceramic filter can avoid thermal energy losses associated with gas cooling and remove particulates. [299, Pytlar 2010]

Candle filters consist of a porous metallic or ceramic filter material that allows gases to pass but not the particulate matter. Candle filters can be operated at temperatures of up to 500 °C and can effectively remove particulates in the 0.5–100 µm range. The filter is regenerated, either by removing the filter cake or by back flushing with steam, dust-free syngas or nitrogen. [293, Brandin et al. 2011]

Conventional electrostatic precipitators may also theoretically be used for dust removal. These can be operated at temperatures of up to around 400 °C and higher (if expensive special steels are used).

Other pollutants: chlorides, ammonia, metals, HCN

Syngas passes through a water scrubber, HCN/COS converter and cooler where chlorides, ammonia, particles, metals and halides are separated (example plants: Tampa, Nuon, ELCOGAS and ENI). Dry feed gasifiers are reporting less mercury emissions than wet feeding gasifiers.

Energy efficiency

Design improvements to existing gasifiers to increase the total fuel utilisation of IGCC plants include:

- geometric modification of the draught dip tube;
- modification of the cooling system;
- geometric modification of the neck and throat gasifier refractory;
- installation of an expander to recover energy from the syngas pressure drop before combustion;

- hot gas cleaning, avoiding the need for gas cooling before cleaning and reheating before feeding the gas turbine.

Excess heat from the primary combustion and syngas-fired heat generation is then passed to a steam cycle, similar to a combined-cycle gas turbine. This may result in improved efficiency compared to conventional pulverised coal combustion but comparable to ultra-supercritical PC combustion. An IGCC plant improves the overall process efficiency by adding the higher temperature steam produced by the gasification process to the steam turbine cycle. This steam is then used in steam turbines to produce additional electrical power.

To achieve an even higher energy efficiency, the plant can be designed with full integration of the air supply unit (ASU) and the gas turbine. All the air fed to the ASU is then supplied (extracted) from the gas turbine compressor (example plant: ELCOGAS).

CO₂ capture

CO₂ capture in IGCC plants is favoured by the high pressure of the gasification process. By means of the water-gas reaction $\text{CO} + \text{H}_2\text{O} \rightarrow \text{CO}_2 + \text{H}_2$, the production of hydrogen can be increased, and CO₂ directly captured using commercial processes, such as MDEA or Selexol absorption technologies, at a pressure that requires less auxiliary power for gas compression. The high moisture content of quenched syngas enables the shift reaction to be conducted with little or no additional steam from the steam cycle.

Achieved environmental benefits

- Reduction in the emissions of SO₂, NO_x and particulates, compared to coal-fired power plants.
- High efficiency and energy security.
- Ability to use lower-grade feedstock while keeping the same low emission levels. In conventional units, low-grade fuels usually result in higher emissions.
- Generation of marketable by-products.

Environmental performance and operational data

Desulphurisation scrubbing can be highly efficient, leading to very low sulphur emissions (e.g. an IGCC unit in Tianjin has an abatement efficiency of > 99 %, and ELCOGAS, see

, has an abatement efficiency of 99.6 %).

If CO₂ scrubbing is installed for subsequent sequestration or other uses, only H₂ is combusted, i.e. only water vapour is emitted by the IGCC process. Very low NO_x emissions can be achieved (according to General Electric, 2 ppmv with hydrogen-rich combustion gas) when in IGCC CCS (carbon capture and storage) operation mode.

Particulate emissions are close to zero, as gas turbines require highly efficient particulate abatement techniques, but levels of NO_x emissions can be higher than from natural-gas-fired turbines.

Table 4.17 to Table 4.22 give emission levels and energy efficiencies achieved by IGCC plants fitted with the techniques described above.

Table 4.17: Data of the Tampa IGCC power plant (Florida, US)

Net output	250 MW				
Design net efficiency, LHV	41.2 %				
Clean gas characteristics	Higher heating value (HHV) 9 932 kJ/Nm ³				
	Composition (vol-%)	42.8 % CO	38.4 % H ₂	14.5 % CO ₂	3.3 % N ₂
		0.9 % Ar	0.1 % CH ₄	200 ppmv S	
NO _x control	Waste N ₂ to combustion chamber				
Sulphur recovery	98 % sulphuric acid production plant				
Emissions (design values), 6 % O ₂	40 mg/Nm ³ SO ₂		100-- 125 mg/Nm ³ NO _x		
<i>Source: [302, Holt 2002]</i>					

Table 4.18: Data of the Nuon IGCC power plant in Buggenum (the Netherlands)

Net output	253 MW	
Design net electrical efficiency, LHV	43.1 %	
Net total fuel utilisation for the gasification block, LHV %, yearly average	92 %	
NO _x control	Gas saturation and mixing with nitrogen	
Sulphur recovery	Claus plant + SCOT plant for tail gas	
Emissions (design values), 6 % O ₂	14 mg/Nm ³ SO ₂	10 mg/Nm ³ NO _x
Emissions (yearly averages – 2011), 6 % O ₂	3 mg/Nm ³ SO ₂	15 mg/Nm ³ NO _x
Emissions (yearly averages – 2011), 6 % O ₂	-	22 ng/Nm ³ Hg
<i>Source: [302, Holt 2002]</i>		

Table 4.19: Data of the Wabash River IGCC power plant (Indiana, US)

Net output	262 MW				
Design net electrical efficiency, LHV	39.2 %				
Clean gas characteristics	Higher heating value (HHV) 10 303 kJ/Nm ³				
	Composition (vol-%)	45.3 % CO	34.4 % H ₂	15.8 % CO ₂	1.9 % N ₂
		0.6 % Ar	1.9 % CH ₄	< 100 ppmv S	
NO _x control	Gas saturation + steam injection				
Sulphur recovery	Claus plant with tail gas recycle				
Emissions (design values), 15 % O ₂	16 mg/Nm ³ SO ₂		40–50 mg/Nm ³ NO _x		
<i>Source: [302, Holt 2002]</i>					

Table 4.20: Data of the IGCC power plant project in Nakoso (Japan)

Net output	250 MW	
Design net electrical efficiency, LHV %	42.0 %	
Gas heating value (LHV)	5 000 kJ/Nm ³ approx.	
NO _x control	SCR	
Sulphur recovery	Gas washing with ash dilution	
Expected emissions, 15 % O ₂	16 mg/Nm ³ SO ₂	8 mg/Nm ³ NO _x

Table 4.21: Data of the Puertollano IGCC power plant (Spain)

Net output	300 MW ISO (282.7 MW at site)				
Design net electrical efficiency, LHV	42.2 %				
Yearly net electrical efficiency (2011)	37.2 %				
Net total fuel utilisation for the gasification block, LHV, yearly average	91.2 %				
Clean gas characteristics	Higher heating value (HHV) 10 472 kJ/Nm ³				
	Composition (% vol.)	60.5 % CO	22.1 % H ₂	3.9 % CO ₂	12.5 % N ₂
		1.0 % Ar	0.01 % CH ₄	< 25 ppmv S	
NO _x control	Gas saturation and mixing with nitrogen				
Sulphur recovery / SO _x removal efficiency (2011)	Claus plant + tail gas recycle / 99.6 % SO _x removal efficiency				
Emissions (design values), 15 % O ₂	10 mg/Nm ³ SO ₂		60 mg/Nm ³ NO _x		
Emissions (yearly averages – 2011), 15 % O ₂	15.5 mg/Nm ³ SO ₂		45 mg/Nm ³ NO _x		
Emissions, (yearly averages – 2011), 15 % O ₂	0.4 mg/Nm ³ dust		120 ng/Nm ³ Hg *		
* Below the detection limit of the analytical technique used.					

Table 4.22: Data of Italian IGCC plants gasifying refinery residues

Emissions (yearly averages – 2011), 15 % O ₂	3–14.5 mg/Nm ³ SO ₂	12–42 mg/Nm ³ NO _x
Emissions (yearly averages – 2011), 15 % O ₂	0.7–2.5 mg/Nm ³ dust	
Yearly net electrical efficiency (2011)	36–46 %	
<i>Source: [3, LCP TWG 2012]</i>		

Availability

The availability of IGCC plants since their start-up is plotted in Figure 4.14. For most of the coal-based plants, the early years had availabilities between 60 % and 80 %. Plants based on petroleum residual oils have performed better, achieving over 90 % availability. The experience accumulated over the past years allows projections to be made for new designs with a significant improvement in the availability.

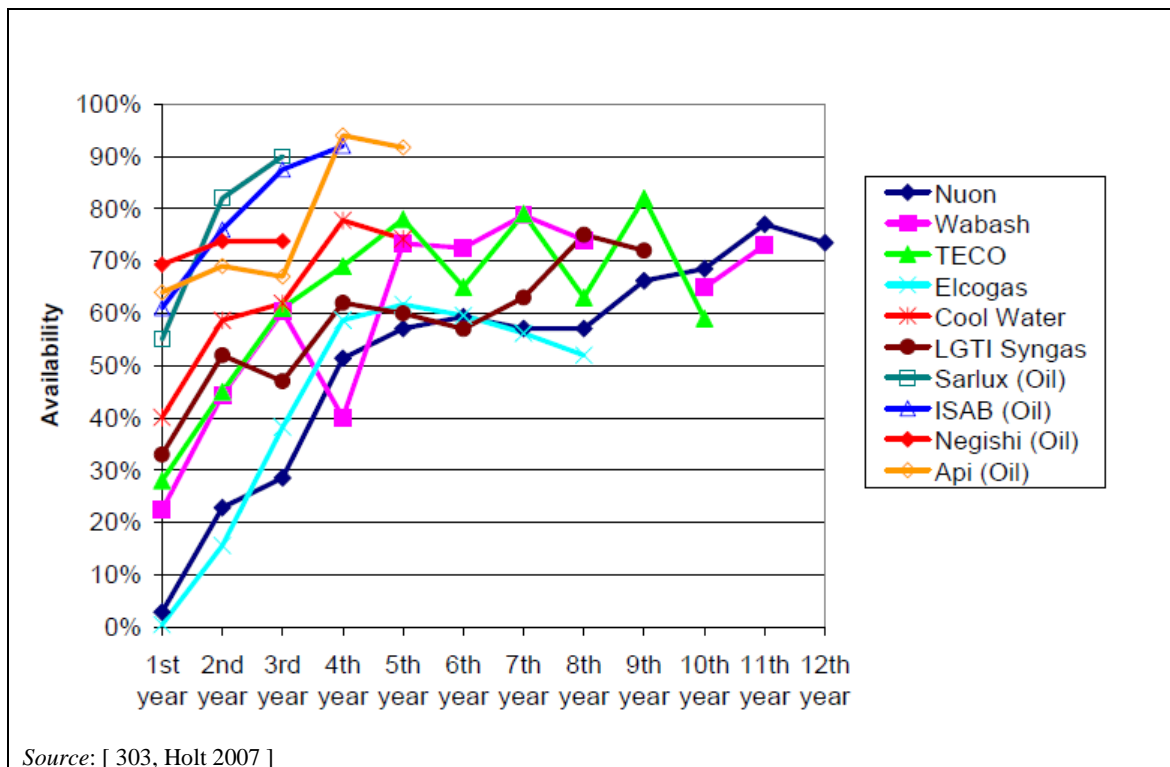

Figure 4.14: Availability statistics for IGCC first-of-a-kind plants

Energy efficiency

In terms of electric power production, the net output of an IGCC plant is given by the output of the gas turbine and of the steam turbine combined, minus the auxiliary power demand. Current IGCC plants have demonstrated that they have enough syngas production capacity to cover the demand of gas turbines at full load, and they all have a net efficiency of around 40 % or higher. (see Table 4.17 to Table 4.22).

Cross-media effects

None.

Technical considerations relevant to applicability

IGCC is a multistage process. Different levels of integration between the gasification island and the combustion block are possible.

The water/steam integration concept has proved successful and most new IGCC projects have adopted it. The integration of the ASU with the combined cycle is also a design option considered. The highly integrated design allows greater power plant efficiency, as the consumption of auxiliary systems for air compressors and ASU products is reduced. Nevertheless, this involves longer start-up times, during which back-up fuel (natural gas in most cases) is used.

With regards to coal-based IGCC power plants that are in operation, in Europe highly integrated design has predominated due to its increased efficiency, whilst in the US increased availability and flexibility has been preferred using non-integrated design alternatives, mainly due to lower fuel prices.

The trend for future IGCC plants is that they will not be designed for total integration of the gas turbine and ASU. The air required by the ASU comes in part from the gas turbine compressor and in part from a separate compressor, so the ASU can be independently started and kept cold. There is still debate about the most appropriate degree of ASU/gas turbine integration. The

optimum amount of air extraction will mainly depend on the overall gas turbine and its compressor characteristics.

Regarding pollutant abatement techniques, they are all generally applicable. The selected techniques depend on the raw fuel and on the required syngas characteristics.

Economics

Capital costs are higher, compared with combined cycles that use natural gas, due to fabrication, cleaning and transport, or compared with combustion boilers with cleaning of the flue-gas. In general, IGCC investment is expected to be higher than for a PC plant without CCS, but the investment for IGCC+CCS is expected to be smaller than for PC+CCS.

Investment is estimated at between EUR 1 million and EUR 1.5 million/MW_{th} (demonstration plant). A study by the International Energy Agency considers that the specific investment for IGCC is about 20 % higher than for pulverised coal combustion. However, there is more uncertainty over IGCC costs as there are no recently built coal IGCC plants and the existing ones were constructed as demonstration plants. Suppliers have plans to bring the capital costs to within 10 % of those of pulverised coal combustion. The challenges are reliability, availability, and investment. IGCC technologies could be commercially available by around 2020 with CCS. [36, EGTEI 2012] [37, EGTEI 2012]

Driving force for implementation

- High fuel and product flexibility.
- High overall efficiency and very low emissions across all pollutants.
- CO₂ capture solution associated with IGCC seems an interesting concept.
- Higher degree of public acceptance than for pulverised-coal-fired units.

Example plants

Coal/water slurry-fed IGCC plants

Polk IGCC power plant, Tampa, Florida, US (55 % petroleum coke/45 % coal).
Wabash River IGCC repowering project, US (petroleum coke).

Dry feed coal

Nuon IGCC power plant, the Netherlands.
ELCOGAS IGCC plant in Puertollano, Spain (fifty-fifty mixture of coal and petroleum coke).
Schwarze Pumpe, Germany.

Dry feed, enriched air-blown

IGCC plant in Nakoso, Japan.

Heavy oil gasification

Isab Energy S.r.l., Italy.
Api Energia, Falconara, Italy.
Sarlux, Sardinia.
Negishi, Japan.
PERNIS, Netherlands.
ENI, Sannazzaro-Ferrera Erbognone, Italy.
Fujian Refinery Ethylene Project, China.

Biomass-fed IGCC plant

Varnamo IGCC, Sweden.

See also Section 4.1.1.

Reference literature

[36, EGTEI 2012] [37, EGTEI 2012]

4.3.1.2 Reduction of emissions from a gasifier connected to an existing coal boiler**Description**

Partial replacement of coal by syngas from biomass and/or other feedstocks, with or without previous syngas cleaning, enables the environmental profile of coal-fired boilers to be improved.

Technical description

The gasifier is connected to an existing coal boiler, either directly (see Figure 4.15) or with intermediate syngas cleaning steps (see Figure 4.16). CFB/BFB gasification with dry gas cleaning prior to the boiler (Figure 4.10 – dry cleaning and chlorine removal) makes it possible to utilise biofuels with a high alkali content (such as straw), as well as SRF with higher chlorine and heavy metal contents.

The gasifier may utilise different feedstocks (solid biofuels and refuse-derived fuels) from the local area. The feedstock is gasified without drying, and the moisture content can be up to 60 %. The capacity of the gasifier depends on the moisture content and on the heating value of the input fuel. Biofuels and/or other feedstocks are gasified at atmospheric pressure at a temperature of about 850 °C.

SO_x emissions decrease due to the lower sulphur content of the syngas replacing the coal. NO_x emissions decrease as the syngas, which has quite a high moisture content due to the gasification of biomass, has a cooling effect in the combustion chamber, allowing a reduction in thermal NO_x generation.

Direct connection gasifier–combustion plant

The hot flue-gas flows through the uniflow cyclone and is slightly cooled down in the air preheater, before being fed into the main boiler. Simultaneously, the gasification air is heated up in the air preheater before feeding it into the gasifier. The syngas is led directly from the gasifier through the air preheater to some boiler burners, which are located below the coal burners in the main boiler. This means that the environmental clean-up (emissions to air) relies on the main boiler flue-gas cleaning installations. The gas can replace roughly 15 % of the coal consumption. Figure 4.15 presents the configuration of the Finnish Kymijärvi plant. Figure 4.16 shows the configuration of the Finnish Vaskiluoto plant.

Connection gasifier–combustion via dry syngas cleaning

The method developed is based on gas filtration at 200–450 °C in a bag filter unit. With solid refuse-derived fuels (SRF) and other fuels containing a lot of plastic material, the filtration temperature has to be higher than 350 °C, in order to avoid tar condensation problems [296, Wilén et al. 2004]. Ceramic (full or light) filter bags are used. Calcium hydroxide or other alkali sorbents are injected into the gas before the filter unit, if necessary, to improve chlorine capture. However, the inherent fuel alkali metals and the calcium-based bed material also react efficiently with HCl during gas cooling and, especially, in the filter cake.

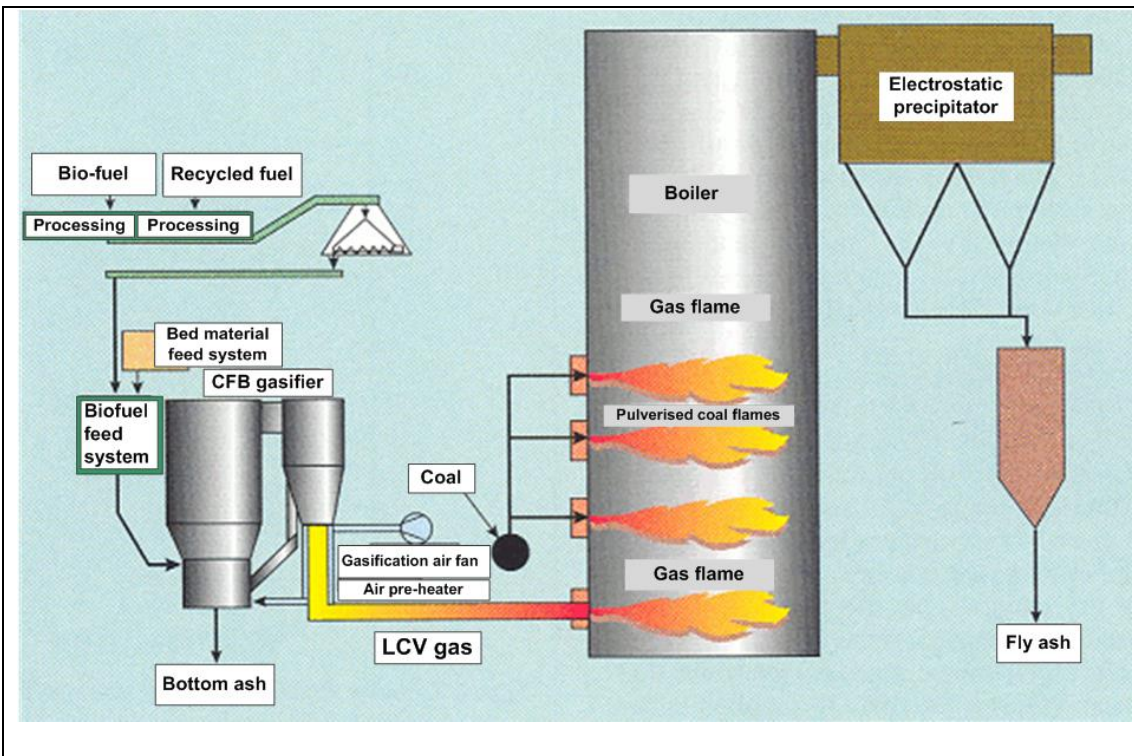
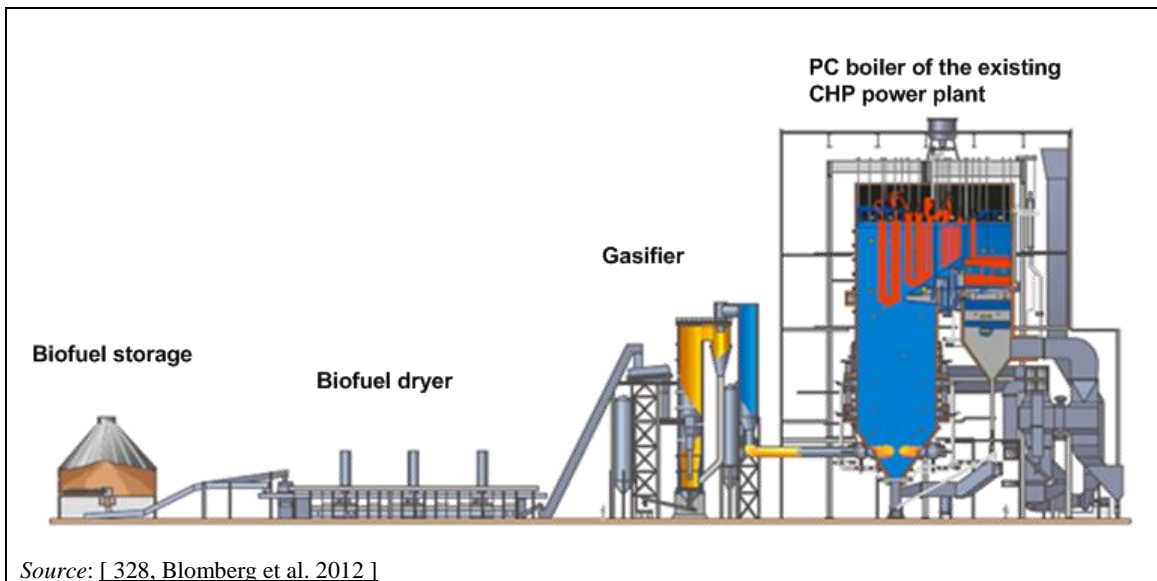

Figure 4.15: Kymijärvi CFB gasifier



Source: [328, Blomberg et al. 2012]

Figure 4.16: Vaskiluoto gasification plant

Achieved environmental benefits

- Reduction of SO₂, NO_x, particulate and metal emissions to air.
- The multi-fuel firing of syngas and coal enables utilisation of an efficient large-scale steam cycle, which results in a high power production efficiency.
- Possible valorisation of challenging fuels, when using syngas treatment techniques.
- Reduced emissions of HCl and metals, when using syngas treatment techniques.

Environmental performance and operational data

The gasification of varying fuel mixes (biomass, SRF, plastic, paper, railway sleepers, shredded tyres) is possible, and with high availabilities (e.g. 96 % availability achieved by the Kymijärvi gasifier, Lahti, Finland). [312, Palonen et al. 2006]

Direct connection gasifier–combustion plant

A comprehensive one-year monitoring program in 1998 studying changes in the main boiler emissions from the Kymijärvi gasifier (Lahti, Finland) demonstrated significantly decreased emissions of CO₂, NO_x, SO_x and particulates from the coal-fired boiler, while the emissions of HCl and some metals increased depending on the quality of the gasified waste when the plant was gasifying 40 % waste and 60 % biofuels. Boiler flue-gas emission measurements from co-firing of syngas and coal in 2001 confirmed these effects [296, Wilén et al. 2004] (see Table 4.6). While no changes were found in the emissions of CO, dioxins, furans, PAHs, benzenes and phenols during monitoring in 1998 [312, Palonen et al. 2006] [316, Raskin et al. 2001], the 2001 measurements indicated a slight increase in the boiler flue-gas emissions of total PAH compounds, polychlorinated benzenes, and polychlorinated biphenyls, while the emissions of chlorophenols and dioxins decreased, as compared to coal-only combustion data from 1997. [296, Wilén et al. 2004]

The most probable reason for the decrease in the dust content of the flue-gas is the increase in the flue-gas moisture content, which enhances the operation of the ESP. The reasons for the decrease in NO_x emissions are, first, the reburning effect of ammonia and, second (and far more importantly), the cooling effect of the low calorific, high-moisture syngas in the bottom part of the boiler.

Because of the extremely low sulphur content of some biofuels, the main boiler's SO_x emissions decrease, while, in contrast, the HCl content of flue-gas increases, because of the higher chlorine content of the SRF and shredded tyres in the gasifier, compared to the low-chlorine coal in the main boiler [316, Raskin et al. 2001]. With regards to the emission of metals, increases in some elements (e.g. Hg) can be seen, but, because of the very low baseline levels in coal combustion, the changes that were measured were in practice very small.

Gasifier–combustion plant connection via syngas treatment techniques

In the case of waste-derived fuels, all heavy metals except mercury can be removed with over 99 % efficiency by filtration [296, Wilén et al. 2004]

. However, final flue-gas cleaning after the boiler may be necessary, in order to fulfil the emission requirements, especially with mercury-containing waste fuels.

Residues

The only residue from the gasifier is bottom ash. In the case of the Kymijärvi gasifier (Lahti, Finland), this consists mainly of sand and limestone. Furthermore, small amounts of solid impurities, such as pieces of metal, concrete and glass may be found in the bottom ash if waste is co-gasified. Typically, the carbon content in the bottom ash is less than 0.5 %. No signs of chlorine are detected [313, Nieminen et al. 2004]. When shredded tyres are used as a fuel in the gasifier, the zinc content in the gasifier bottom ash increases from a few hundred ppm to 3 000 ppm. All other analysed elements are in the range of a few or tens of ppms (As, Cd, Ni, Pb and Hg), or in the range of hundreds of ppms (Cr and Cu). [316, Raskin et al. 2001]

In the case of direct connection of the gasifier to the boiler, the share of the gasifier fly ash of the main coal-boiler total filter ash is small, only 3–5 %, and hence changes in the main boiler filter ash quality caused by the gasifier are very small, even in the case of waste co-gasification. The biggest change is seen in the zinc content when shredded tyres are used as fuel in the gasifier. [316, Raskin et al. 2001]

In the case of syngas pretreatment, a dry filter dust is produced, in addition to bottom ash from the gasifier. The filter dust contains unconverted carbon (char), the finest fraction of the bed material, inert matter from the feedstock, and chlorine removal sorbent.

Cross-media effects

Depending on the gasified feedstock (e.g. if waste is co-gasified with biomass), some pollutants such as HCl and metals may be increased in emissions to air. For instance, the use of contaminated materials (e.g. glue containing nitrogen and sodium) increases the concentration of ammonia, hydrogen cyanide and alkali in the syngas. [316, Raskin et al. 2001]

Technical considerations relevant to applicability

The most simple process configuration without gas cleaning (see Figure 4.10 – raw gas (clean fuel)) is suitable for feedstocks which do not contain significant amounts of alkali and metals or chlorine, as in this process a relatively large part of the biomass ash is led together with the product gas into the coal boiler. Such feedstock includes wood chips, sawdust and bark, forest residue chips and some clean plastic or paper wastes. This technology is available as a commercial technology.

Due to the effective removal of chlorine, alkali metals and heavy metals, the configuration with dry syngas pretreatment can also be applied for many challenging biomasses and waste-derived fuels. For example straw, energy crops and different agricultural residues are fuels which often require gas cleaning to lower the alkali and chlorine content before combustion in a boiler, which involves high steam temperatures.

Economics

The gasifier-PC boiler process connection offers low investment and operating costs, thanks to the utilisation of existing power plant capacity, with only small modifications to the main boiler.

The total costs of the 60 MW_{th} gasification plant at the Kymijärvi power plant were about EUR 12 million, including the fuel preparation plant, civil works, instrumentation and control, as well as electrification works.

Driving force for implementation

Replacement of coal by almost CO₂-neutral biomass-derived gas reduces fossil-fuel CO₂ emissions. In PC boilers, the multi-fuel firing of gas with coal is significantly simpler than the multi-fuel firing of solid biomass with coal.

Example plants

A pioneering plant for the configuration without gas cleaning has been in successful operation in Lahti, Finland (Kymijärvi) since 1998. There the product gas from a 60 MW_{th} gasifier replaces 15 % of the coal input in a PC boiler. A larger unit of 140 MW_{th} was recently put into operation in Vaasa (Finland) to replace about 25 % of the coal in a PC boiler.

The first industrial gasification plant based on the dry syngas treatment was put into commercial operation in 2012 in Lahti Finland (Kymijärvi II gasification plant with two 80 MW gasifiers connected to a separate gas-fired boiler). Source-separated industrial and household wastes and demolition wood are used as the feedstock at this plant.

Other plants:

Corenso Oy, Varkhaus, Finland.

Electrabel, Ruien, Belgium.

Essent, Amercentrale, Netherlands.

Biococomb, Austria.

Reference literature

[314, Kurkela 2002] [296, Wilén et al. 2004]

4.3.1.3 Biomass gasification connected to engine plants with prior wet gas cleaning

Technical description

Gasification with wet gas cleaning (Figure 4.10 – wet cleaning) is a process which can produce a very clean gas for subsequent use, e.g. in gas engines. However, it produces a waste water stream, and the waste water treatment may be difficult to design in a fully environmentally acceptable manner [296, Wilén et al. 2004]. Problematic substances in the waste water from the gas scrubber, which may be difficult to handle/eliminate, include benzene, naphthalene, PAHs and phenol.

A low-pressure biomass gasifier associated with a gas clean-up system has been developed for use in gas-engine-based combined heat and power (CHP) plants. The first plant (Skive, Denmark) produces 6 MW_e and 12 MW_{th} for district heating (Figure 4.17). The gasification plant processes include an air-blown, low-pressure bubbling fluidised bed (BFB) gasifier with limestone-based bed material, a catalytic tar reformer, gas cooling and filtration, and a gas scrubber. The power plant processes include three gas engines with heat recovery (three 2 MW_{th} gas engines) and two optional gas boilers (two 10 MW_{th} gas boilers).

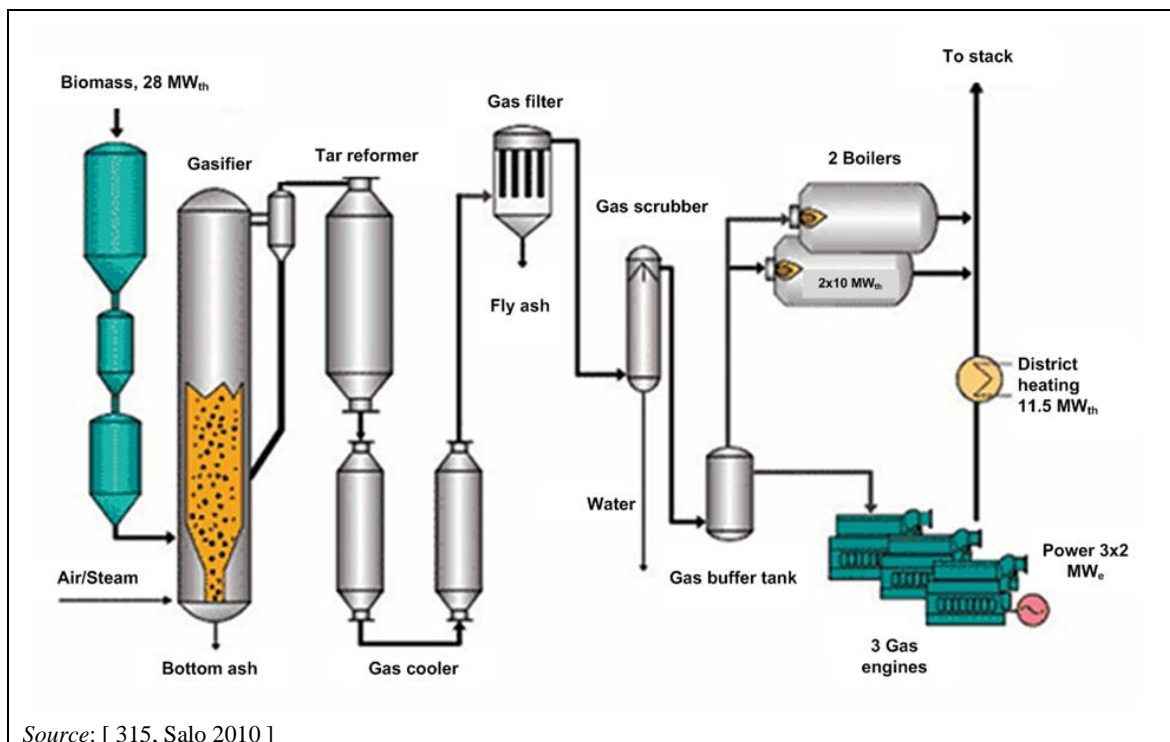

Figure 4.17: The Skive CHP flowsheet

The BFB gasifier is fed with wood pellets and chips and operated at a pressure of 0.5–2 bars. The bed material is dolomite, giving the gasifier some tar cracking capability; the tar level after the gasifier is claimed to be low. Dolomite is a naturally mixed calcium–magnesium carbonate; when used for tar cracking, it is decomposed by heating into calcium–magnesium oxide, which is the active component. However, if the CO_2 partial pressure becomes too high, the oxide reverts to carbonate at the gasification temperature. Other bed material has been or is being tested to find a way to avoid this. [293, Brandin et al. 2011]

Gas cleaning with catalytic tar reforming

The syngas enters the catalytic tar reformer, which operates at a temperature of 850–950 °C. As the reforming reaction is endothermic, this might mean that the syngas enters at 950 °C and leaves at 850 °C. No soot forms and the pressure drop is stable, but steam/nitrogen pulsing is used to clean the catalyst bed.

The ammonia in the gas is decomposed by ammonia cracking over the reforming catalyst. As the ammonia is very water-soluble, it follows the condensate and ends up in the scrubber water and finally the waste water. The nitrogen level in the waste water is too high to be accepted at municipal waste water plants. An activated carbon filter is also needed to treat the waste water to reduce its organic content.

Achieved environmental benefits

- High energy efficiency; high electrical efficiency of gas engines, even at small sizes.
[293, Brandin et al. 2011]
- Overall air emission levels: according to the Environmental Approval for Skive CHP (Skive Municipality, 2005), the most important emissions to air from the gas engines are NO_x, unburnt hydrocarbons, CO and formaldehyde, and, apart from CO, the emission limit values in the legislation are the same as for natural-gas-fired engines.

Environmental performance and operational data

Such a gasification plant, when fully automated, can use all combinations of gas consumers (gas engines and gas boilers), ensuring a large flexibility.

Achieved efficiencies at Skive CHP (Skive Fjernvarme, 2012) are:

- total fuel utilisation: 86 %;
- electrical efficiency: 30 %;
- thermal efficiency (heat for district heating): 56 %.

The initial tar conversion over the catalyst was 90 %, but decreased to 70 %. However, no heavy tars were found after the reformer completed 7 500 hours of operation. The ammonia conversion over the catalyst is low, and a maximum of 60 % is obtained.

The environmental performance (emissions and consumption levels) per MWh produced (heat and electricity) over the 2007–2012 period are given in Table 4.7 and Table 4.16.

Cross-media effects

Waste water produced from the gas scrubber contains sludge, organic compounds and inorganic species. At the Skive plant, this is handled by a combination of mechanical treatment, activated carbon filtering for removal of C_xH_y, and pH neutralisation by NaOH and CH₂O₂ before the waste water from the scrubber is discharged to the municipal waste water plant. According to the waste water discharge permit for Skive CHP (Skive Municipality, 2005), there are potentially four problematic substances in the waste water from the gas scrubber which may compromise the water quality of the recipient: benzene, naphthalene, PAHs and phenol.

The ammonia content of the condensate has also been mentioned as a problem, given the emission regulation at the municipal water treatment plant at the Skive plant, despite the catalytic reforming step for the tars. [293, Brandin et al. 2011]

Another drawback of the system is the gas engine's exposure to corrosive combustion products, resulting in short and expensive maintenance intervals. [293, Brandin et al. 2011]

Technical considerations relevant to applicability

No information provided.

Economics

Investment costs are roughly 50 % higher than in the dry gas cleaning or directly connected options. [296, Wilén et al. 2004]

Driving force for implementation

High electrical efficiencies of gas engines (even at small sizes), low cost, and reliability; they also even work well at low loads. [293, Brandin et al. 2011]

Example plants

Skive CHP, Denmark.

Reference literature

No information provided.

4.3.2 Techniques to prevent and/or control water pollution from the gasification process

Description

Waste water is recirculated after internal treatment in IGCC plants and gasification plants using syngas wet cleaning techniques.

Technical description

Gasification plants may use a water scrubber, HCN/COS converter and cooler for removing pollutants from the syngas, such as chlorides and other halides, ammonia or particulates. The generated stream is sent to the water treatment unit prior to recirculation. Dissolved gases such as H₂S, NH₃ and CO₂ are stripped out.

Because the water is reused for moisturising the syngas before being combusted in gas turbines or engines, the salt content of the water should be low. The water is evaporated to remove the salts (mainly NaCl) and the condensate is also treated in a dedicated demineralisation plant to achieve a low salt content (Cl < 0.05 mg/l).

Achieved environmental benefit

- Reduced overall emissions to water.
- Reduced water consumption.

Environmental performance and operational data

No information provided.

Cross-media effects

No information provided.

Technical considerations relevant to applicability

No information provided.

Economics

No information provided.

Driving force for implementation

Zero liquid discharge in the environmental permit.

Example plants

Nuon, ELCOGAS and Tampa.

Reference literature

No information provided.

4.3.3 Techniques for the management of residues from the gasification process

Description

Residues reuse.

Technical description

The bottom ashes from gasification may either be removed dry, or as slag if the gasifier operating temperature is well above the ash fusion temperature, which is often the case in entrained-flow gasifiers for example. The gasifier slag is separated in a molten state through the bottom of the gasifier, cooled in a bath of water and extracted using lock hoppers. Slag can be removed continuously from the slag bath at the base of the gasifier via a let-down system, which seems to show benefits in relation to lock hopper systems. The quality – and hence the reuse potential – of the gasification slags may be better than that of the corresponding combustion ashes due to their glassy and chemically stable form.

Sour gas is converted to solid sulphur in a Claus unit, and tail gas from the Claus unit is hydrogenated before being recycled to the COS hydrolysis unit, allowing recovery of 98 % of the total fuel sulphur content as elemental sulphur. Sulphur can also be recovered as gypsum, e.g. by washing with a limestone solution. The plant includes a syngas cooler, hot gas filter and cold gas clean-up using COS hydrolysis and MDEA for H₂S removal. The H₂S-rich gas is burnt and the flue-gases scrubbed with limestone slurry to produce gypsum for sale. This technique has been developed where there is very little market for elemental sulphur, like in Japan.

Depending on the market situation, slag and recovered sulphur are likely to be traded. The slag can be used in the manufacturing of flooring tiles for example, and sulphur can be used in the manufacture of fertilisers and sulphuric acid.

For the fly ashes, the quality and reuse potential may vary significantly, depending on the syngas cleaning technology used, the gasification technology and the quality of the original feedstock. In some cases, the fly ash will have a good quality and will not contain sorbents, and these fly ashes may be marketed (example plants: Nuon and ELCOGAS IGCC plants).

If the gasification process is based on low temperatures (700–800 °C), and the fuel is biomass or some waste fractions, it is possible to produce a fertiliser product from the fly ash and bottom ash. The nutrients from the fuel (especially potassium and phosphorus) can thereby be returned to the fields, and the heating value efficiently used for energy purposes. The process temperature is kept low, to maintain a high availability of the nutrients in the fertiliser, especially phosphorus. Carbon-in-ash has a beneficial effect on agricultural soil, where it contributes to lower leaching of nutrients and an increased water-holding effect of the soil for example. The carbon derived from a low-temperature gasification process is also stable in the soil, while for instance when wheat straw is tilled into the soil, only a few per cent of the carbon remains in the soil, and the rest is released as mainly CO₂. [300, Pyroneer 2017]

Achieved environmental benefits

Reduced transfer of pollutants to the environment.

Environmental performance and operational data

See Section 4.2.1.

Cross-media effects

Without proper separation, the slag may contain an intermediate size fraction with a high ash content, which makes its sale difficult.

Technical considerations relevant to applicability

Filter dust from syngas filtration may contain a mixture of sorbents, unreacted carbon, and all the impurities of the original feedstock, and disposal may be the only option. The final disposal methods of the filter dust must be designed on case-by-case basis, depending on the original feedstock composition.

Economics

No information provided.

Driving force for implementation

No information provided.

Example plants

Tampa (US).

Nuon (the Netherlands).

Wabash River (proprietary slag removing system, US).

Nakoso (Japan).

ELCOGAS (Spain).

Reference literature

No information provided.

4.3.4 Techniques to increase the energy efficiency of the gasification process

4.3.4.1 High-temperature and -pressure gasification

Description

The use of a gasification technique with high-temperature and -pressure operating parameters enables the maximum carbon conversion rate to be achieved.

Achieved environmental benefit

Reduced fuel consumption and increased energy efficiency.

Environmental performance and operational data

In the ELCOGAS plant (Spain), the gasification reaction takes place in the gasifier combustion chamber at a high temperature, between 1 600 °C and 1 800 °C, and at a high pressure of 24 bar, enabling a carbon conversion for the gasification of more than 98 %.

In Nakoso (Japan), a low syngas temperature of approximately 1 100 °C simplifies the cooling system but means a lower conversion rate.

Technical considerations relevant to applicability

No information provided.

Cross-media effects

No information provided.

Economics

Pressurised systems significantly reduce the costs of syngas clean-up and overall capital costs. Capital costs decrease largely due to the decreasing gas volume in the cleaning section. The extra costs for air or oxygen compression are more than outweighed by smaller syngas clean-up equipment and reduced compression costs downstream, and hence pressurised systems have a lower total capital cost than atmospheric systems. [295, E4Tech 2009]

Driving force for implementation

No information provided.

Example plants

ELCOGAS (Spain) and Nakoso (Japan).

Reference literature

No information provided.

4.3.4.2 Dry feedstock feeding system

Description

The use of a dry system for feeding the fuel to the gasifier enables improvements in the energy efficiency of the gasification process.

Technical description

In entrained-flow gasification of coal, the fine coal can be fed to the gasifier in either a dry or slurry form. The former uses a lock hopper system, while the latter relies on the use of high-pressure slurry pumps. The slurry feed is a simpler operation, but it introduces water into the reactor which needs to be evaporated. The result of this additional water is a syngas product with a higher H₂ to CO ratio, but with a lower gasifier thermal efficiency. The feed preparation system needs to be evaluated, along with other process design alternatives.

Achieved environmental benefit

Reduced energy consumption and increased energy efficiency.

Environmental performance and operational data

In the Nuon plant (the Netherlands), the cooled syngas heating value typically contains ~80 % of the heating value of the coal feed. This is higher than that achievable with the coal/water slurry-fed systems.

Technical considerations relevant to applicability

No information provided.

Cross-media effects

No information provided.

Economics

No information provided.

Driving force for implementation

No information provided.

Example plants

Nuon (the Netherlands) and ELCOGAS (Spain).

Reference literature

No information provided.

4.3.4.3 Use of recovered heat from the gasification process

Description

The heat recovered from syngas cooling is reused internally to dry the fuel or produce additional heat/power in order to reduce heat losses and to improve the process energy efficiency.

Technical description

Biomass gasification systems differ from combustion systems as for gasification systems it is usually necessary to dry the biomass prior to feeding it into the gasifier. The general

requirement for the moisture content in biomass is $< 20\%$ moisture. However, some systems can handle wet biomass with up to 60% moisture (e.g. at the Kymijärvi plant, Lahti, Finland). A variety of drying methods, including fluidised bed and rotary mechanisms, direct exposure to flue-gas, or a thermal fluid, exist [299, Pytlar 2010]. In order to avoid losing the energy used to drive off water, heat recapture is favoured.

Achieved environmental benefit

Reduced energy consumption and increased energy efficiency.

Environmental performance and operational data

In the ELCOGAS plant (Spain), the raw syngas is quenched with recycled syngas to a temperature of $800\text{ }^{\circ}\text{C}$ upon leaving the combustion chamber. The syngas is then cooled in two water-tube boilers down to $250\text{ }^{\circ}\text{C}$, generating a HP and IP steam that is superheated in the HRSG of the power block and sent to the steam turbine. The recovered energy enables the energy efficiency of the gasification process to be improved from 74.1% to 91.2% (yearly average).

In the Nuon plant (the Netherlands), the raw syngas is quenched with recycled syngas to a temperature of $800\text{ }^{\circ}\text{C}$ upon leaving the gasifier reactor. The syngas is then cooled in a syngas cooler down to $235\text{ }^{\circ}\text{C}$, generating HP and IP steam (which is superheated in the HRSG of the power block and sent to the steam turbine) and LP steam for gasification and gas cleaning. The recovered energy enables the energy efficiency of the gasification process to be improved from 77.1% to 92% (yearly average).

Technical considerations relevant to applicability

No information provided.

Cross-media effects

No information provided.

Economics

No information provided.

Driving force for implementation

No information provided.

Example plants

ELCOGAS (Spain) and Nuon (the Netherlands).

Reference literature

No information provided.

4.3.4.4 Full integration of the air supply unit (ASU) with the gas turbine in IGCC plants

Description

The air separation unit (ASU) and the gas turbine are fully integrated, meaning that the entire air feed for the ASU is supplied (extracted) from the gas turbine compressor.

Achieved environmental benefit

Increased energy efficiency.

Environmental performance and operational data

No information provided.

Technical considerations relevant to applicability

No information provided.

Cross-media effects

No information provided.

Economics

No information provided.

Driving force for implementation

No information provided.

Example plants

ELCOGAS (Spain).

Reference literature

No information provided.

5 COMBUSTION OF SOLID FUELS

5.1 Combustion of coal and/or lignite

The current situation of coal- and/or lignite-fired large combustion plants in the EU, regarding capacity, number of units and age of the plants, is presented in Figure 5.1 to Figure 5.4.

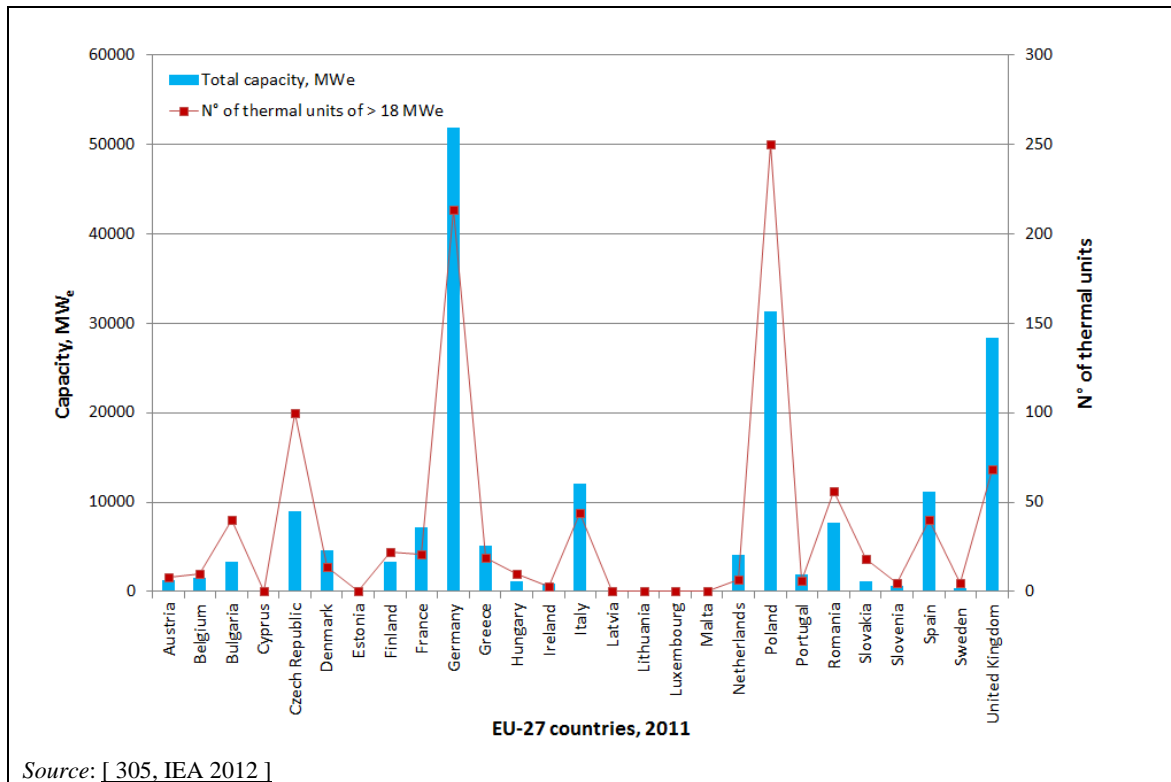

Figure 5.1: Capacities of coal- and/or lignite-fired power plants in EU-27 countries in 2011

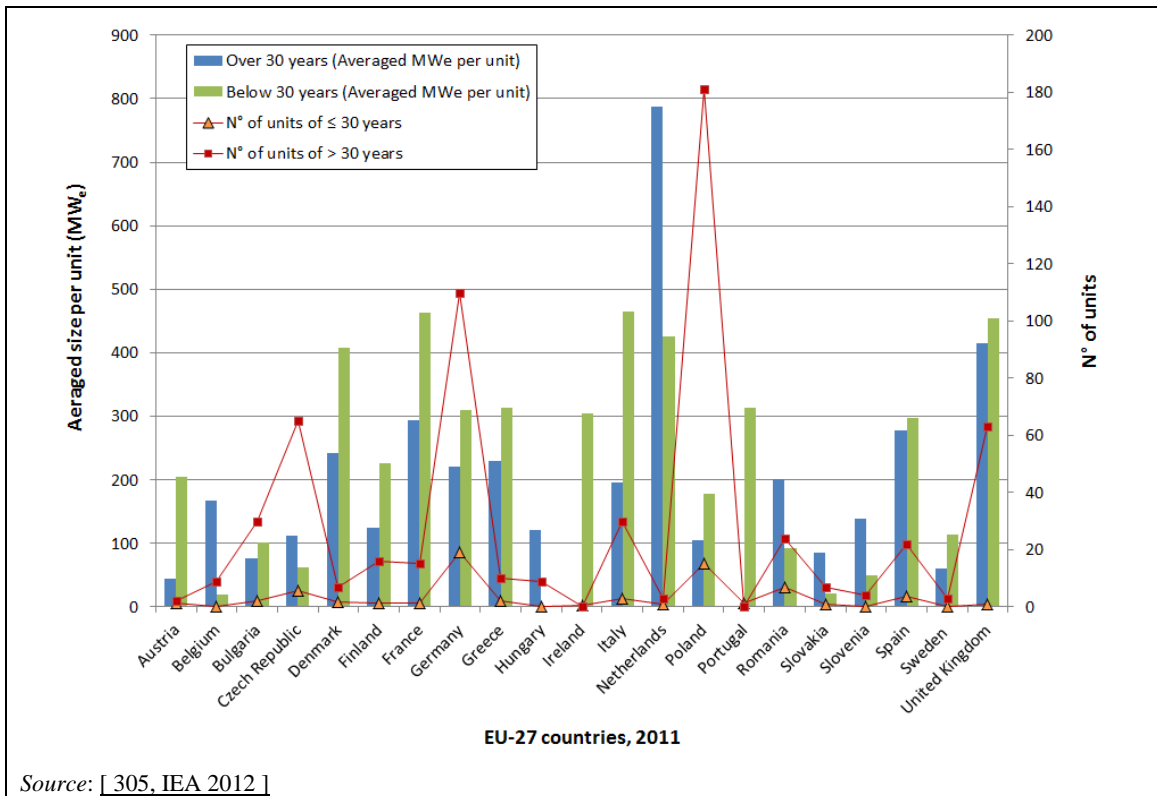

Figure 5.2: Capacity, age and number of units of coal- and/or lignite-fired power plants in EU-27 countries in 2011

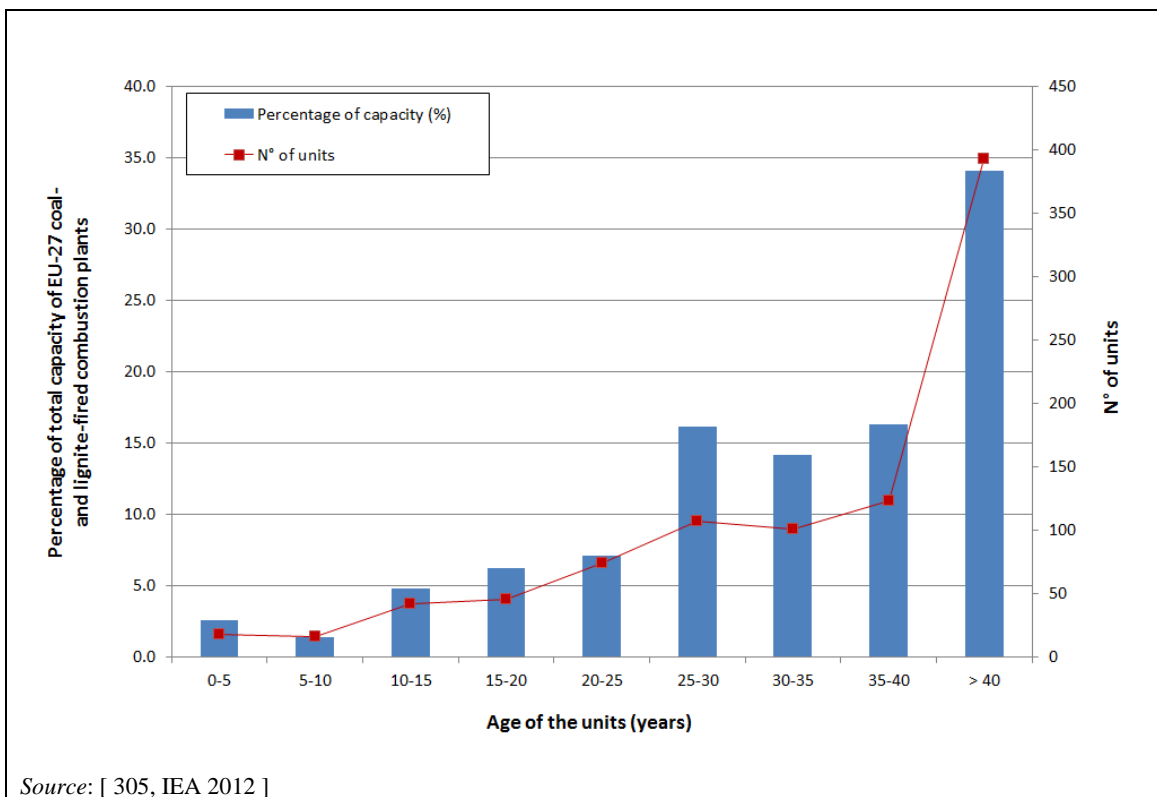

Figure 5.3: Age and number of units of coal- and/or lignite-fired power plants in EU-27 countries in 2011

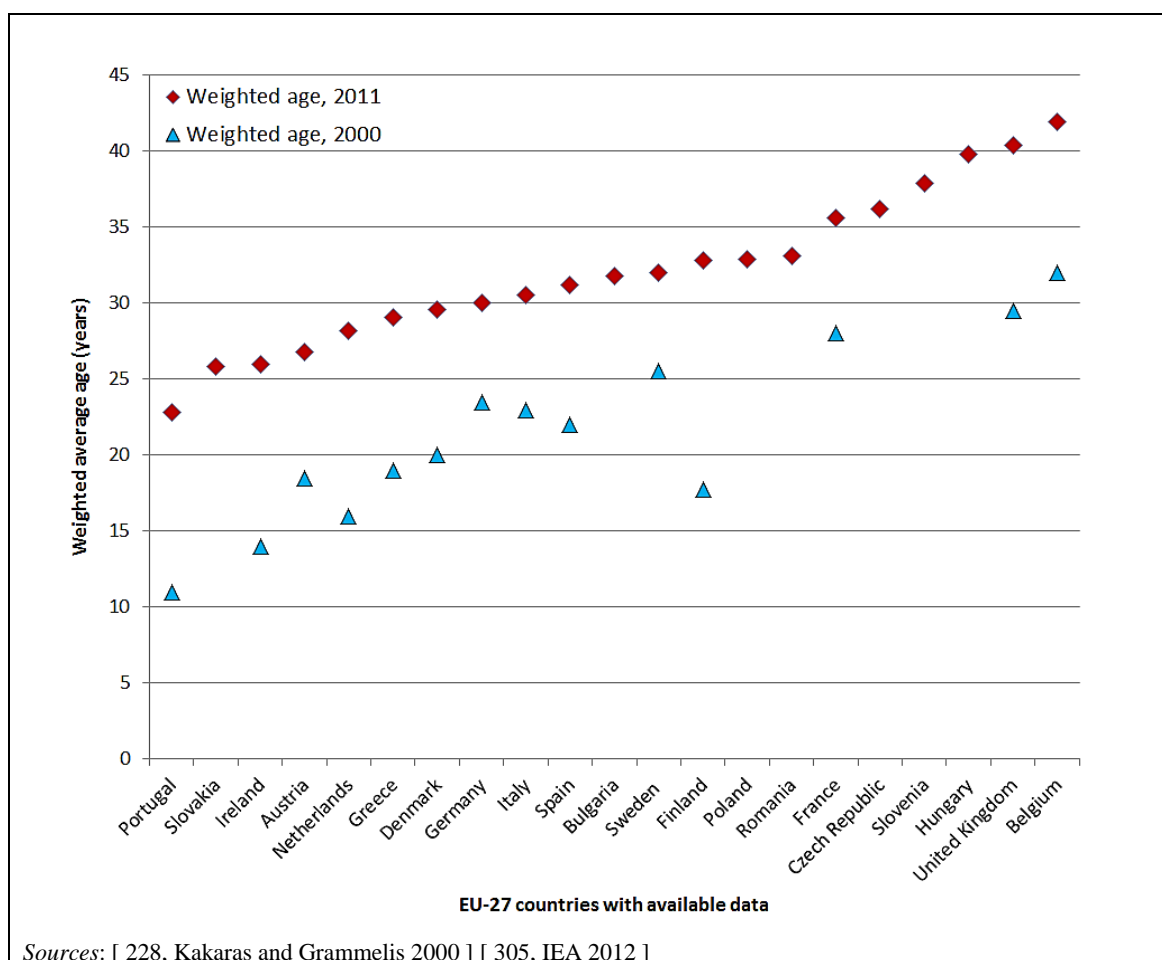

Figure 5.4: Capacity-weighted average age of coal- and/or lignite-fired power plants in EU-27 countries

5.1.1 Applied processes and techniques

In this section, information is provided about processes and techniques applied in large coal- and/or lignite-fired combustion plants.

Coal has a higher energy density than lignite. It is transportable and tradeable worldwide. Therefore coal combustion plants are generally planned universally, unlike lignite combustion plants that are situated at the mining site and tailor-made for the specific fuel quality.

In most steam-only condensing power plants in operation today, the coal input to power output ratio (i.e. heat rate) is in the range of 2.5–3.1 (i.e. efficiency of 32–40 % on a LHV basis). In other words, for each unit of power output, at least 1.5 units of heat are lost into the atmosphere via the stack and into the cooling system, mainly via the condenser. The established standard practice since the 1960s has been to use either natural circulation boilers or forced circulation boilers, with a boiler steam pressure at around 170 bar, or once-through boilers with a pressure of up to 240 bar. In both cases, the superheating and reheating temperatures are around 540 °C or 570 °C, depending on the selected pipe materials. Using the most advanced high-temperature materials, coal-fired condensing power plants with a steam pressure of approximately 300 bar and a steam temperature approaching 600 °C have recently been built. For example, a coal-fired condensing plant (Plant 34) with a net heat rate of 2.08 (efficiency of 48 %) was commissioned in 1998 in Denmark using direct water cooling. [229, MPS 1998] [3, LCP TWG 2012]

A condensing lignite-fired power plant with an ESP, a wet FGD plant and a cooling tower discharge of flue-gases is shown in Figure 5.5.

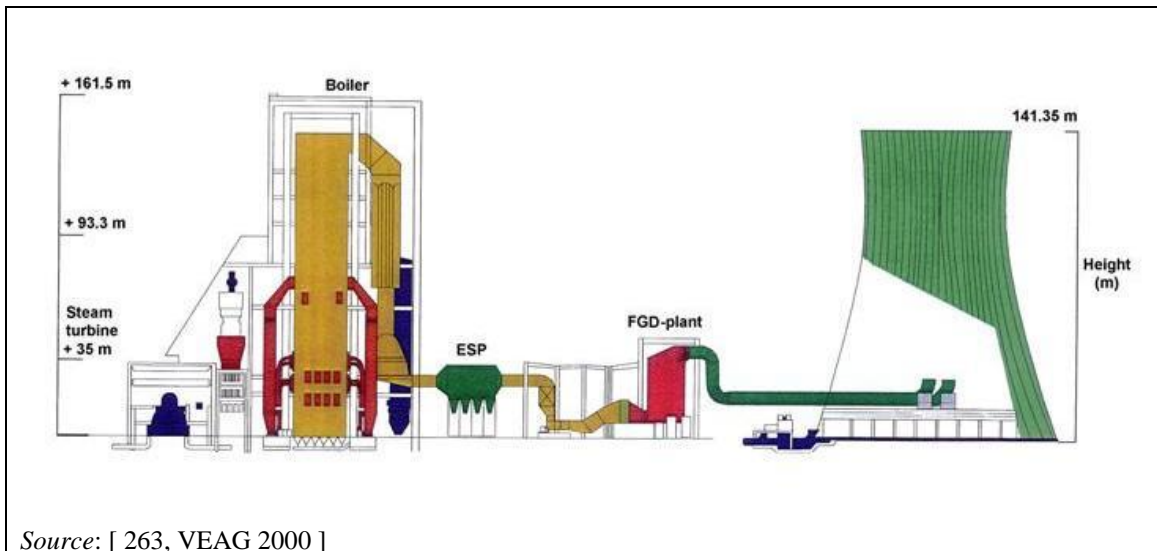

Figure 5.5: Example large lignite-fired power plant with cooling tower discharge

Most of the coal- or lignite-fired condensing power plants built in the 1990s have a net heat rate of around 2.3 (efficiency of 43 %). When possible, direct once-through cooling is used to achieve the lowest possible condenser pressure and temperature, to maximise the plant's power generation efficiency.

Today's condensing power plant units are usually quite large, typically with power outputs from 300 MW_e to 1 200 MW_e. At such big plants, the fuel is burnt in pulverised coal burners. As larger fluidised bed combustion (FBC) boilers have become available, they have also been used in smaller condensing plants. Currently, the largest condensing FBC power generation unit in operation has a power output of 600 MW_e. However, concept studies exist for a 800 MW_e unit.

The fluidised bed technique is used for the combustion of coal rich in ash and/or waste coal such as discarded coal.

5.1.1.1 Fuel characterisation

Coal deposits were formed as the result of complex anaerobic biochemical reactions under the effects of temperature, pressure and time. The reactions took place in stratified underground plant debris, enriching the carbon and hydrocarbon content of the original organic material. The chemical properties of coal depend upon the properties of the different chemical components present in the parent plant debris, the nature and extent of the changes, and the nature and quantity of the inorganic matter present.

The first, immature product of the 'coalification' process is peat, while the product of the last degree of 'coalification' is anthracite. The degree of change of chemical composition of coal within the series of fossil fuels from peat to anthracite is known as the rank of the coal and corresponds to an increase in equivalent energy of coal (calorific value). Coals are classified and ranked based on certain properties, as determined by chemical analyses, and certain other factors, such as their agglomerating nature. Analyses are:

- **proximate analysis** - giving information on the behaviour of coal when it is heated (e.g. moisture, volatile matter, fixed carbon);
- **ultimate analysis** - giving information to assist in the selection of coal for steam generation (e.g. total carbon, hydrogen, nitrogen, oxygen, calorific value, ash fusion temperature, grindability and sulphur content).

Three major classification systems have been developed based upon the proximate analysis of coals:

ASTM classification, developed in the US

According to the ASTM classification, there are four classes of coal, based on fixed carbon and volatile matter (on a dry, mineral matter-free basis) and calorific value (on a moist, mineral matter-free basis):

- anthracite,
- bituminous,
- sub-bituminous,
- lignite.

FRB/NCB classification, developed in the UK

According to the FRB/NCB classification system, based upon volatile matter (on daf) and burning properties (Gray-King Assay) there are four classes of coal:

- anthracite,
- low volatile steam coals,
- medium volatile coals,
- high volatile coals (consisting of six subclasses).

UN/ECE international classification system

According to the 'International Codification System' for medium and high rank coals and the 'International Codification System' for low rank coal utilisation, developed by the UN/ECE, coals are defined as **higher rank** and **lower rank coals**, based upon their gross calorific value (on a moist, ash-free basis) and vitrinite mean random reflectance in oil. These categories are divided further into subcategories. The higher ranking coals are divided into **medium and high rank coals**, while the lower ranking coals are divided into **lignite** and **sub-bituminous coals**.

For the purpose of this document, only the distinction between coal and lignite has been considered, and 'coal' covers the different types of coal.

The composition of lignite and coal differs over a broad range, as shown in Table 5.1. This is also true for the concentration of metals and trace elements in lignite and coal, as can be seen in Table 5.2.

Table 5.1: Indicative analyses of typical coals and lignites (general practice)

Property	Units	Lignite	Coal		
			Bituminous	Low volatile bituminous and semi-anthracite	Anthracite
Moisture	(% as received)	30–70	2–20	2–20	2–20
Ash	(% as received)	5–40	1–30	1–30	1–30
Volatile matter	(daf %)	40–70	> 22	8–22	< 8
Fixed carbon	(daf %)	35–60	55–85	85–92	> 92
Total carbon	(daf %)	60–80	80–95	90–95	92–95
Hydrogen	(daf %)	4.5–6.5	4.5–6.5	3.5–4.5	3–8
Oxygen	(daf %)	12–30	1.5–14	1.2–6	1.2–5
Sulphur	(daf %)	0.5–4.7	0.3–4.5	0.5–1	0.5–0.8
Higher heating value	(MJ/kg daf)	23–35	32–38.5	35–38	35–38
Lower heating value	(MJ/kg raw)	4–30	26–32	25–32.3	30–31.4
N	(dry basis, wt-%)	0.3–1.5	0.6–2	1.4–4	0.9–1.7
Hg	mg/kg	0.03–0.22	0.01–0.9	0.07–0.1	0.06–0.2
Cd	mg/kg	0.3–5	0.01–10	0.2–1	0.06–4
Tl	mg/kg	2–8	0.01–3.5	NA	1–2
Sb	mg/kg	0.5	0.02–20	0.1–2.1	0.5–5.2
As	mg/kg	10	0.1–22	1–8	0.9–15
Pb	mg/kg	0.1–15	0.1–128	5–15	4–122
Cr	mg/kg	65–77	0.6–300	24–32	10–470
Co	mg/kg	11–12	0.5–60	NA	4–60
Cu	mg/kg	35–37	1–165	28	9–35
Mn	mg/kg	141	3–500	37–95	30–530
Ni	mg/kg	32–40	0.7–180	13–26	11.5–225
V	mg/kg	100–107	1.2–390	12–33	18–305
Zn	mg/kg	50–56	1.2–385	8–20	1.4–412
NB: daf: dry and ash-free basis. Lower heating value data from EVT Handbook 1990. Sources: [123, Eurelectric 2001] [3, LCP TWG 2012]					

Table 5.2: Indicative concentrations of metals and trace elements in coals from different regions

Values in mg/kg	Australia	Canada	US	Poland	Russia and CIS	Europe
Ash (%)	12.5	12.9	9.9	15.9	15.4	14.4
As	1.4	2.9	8.7	3.4	4	18.5
Ag	NA	NA	0.86	< 1.7	< 1.6	0.74
Ba	NA	NA	280	500	210	240
Be	1.4	0.8	1.9	1.6	0.7	2
B	12.3	58	46	NA	NA	NA
Cd	0.06	0.3	0.24	0.73	0.27	0.2
Cr	7.4	7.4	13.9	16.3	40	18.7
Cu	13.3	16.9	16.6	NA	NA	NA
Cl	300	300	800	NA	NA	NA
Co	NA	NA	6.2	5.3	3.2	6.2
Cs	NA	NA	1.92	3.3	0.9	1.3
F	62	82	55	NA	NA	NA
Hf	NA	NA	1.1	1.6	1.2	0.7
Hg	0.04	0.05	0.11	0.09	0.12	0.131
La	NA	NA	13.9	11.3	10.4	11.1
Mn	132	149	19	200	135	80
Mo	0.9	1.6	5.3	< 1.1	< 1.1	< 0.87
Ni	9.5	7.3	10.7	< 24	21	< 12.5
Pb	4.8	6.8	8.6	32	12.2	9.9
Rb	NA	NA	16.1	23	12.3	21
Sb	NA	NA	1.15	1.6	0.65	1.12
Sc	NA	NA	5.6	5.9	6.9	5.4
Sn	NA	NA	< 26	< 62	< 57	< 25
Se	0.8	1.1	3.9	NA	NA	NA
Th	2.3	3.3	4.2	4.1	3	3.5
Ti	0.15	0.1	0.5	NA	NA	NA
U	0.7	1.2	1.1	1.7	1.4	1.47
V	14.8	30	23.3	38	39	43
Zn	19	8.9	14.1	< 27	< 6.6	< 3.2
Zr	NA	NA	47	39	28	18.3
NB: NA: Not available. Source: [264, Itkonen, A. and Jantunen, M. J. 1989]						

It is important to know as much as possible about the properties of the solid fuel burnt, in order to be able to appropriately design the LCP installations and equipment to achieve the best performance. It is equally important to burn the correct fuel for which the LCP was designed, or at least a fuel with similar properties. This ensures high efficiency in the long term, as well as trouble-free operation and an optimal environmental performance.

The influence of the coal quality on the performance of the combustion plant is shown schematically in Figure 5.6.

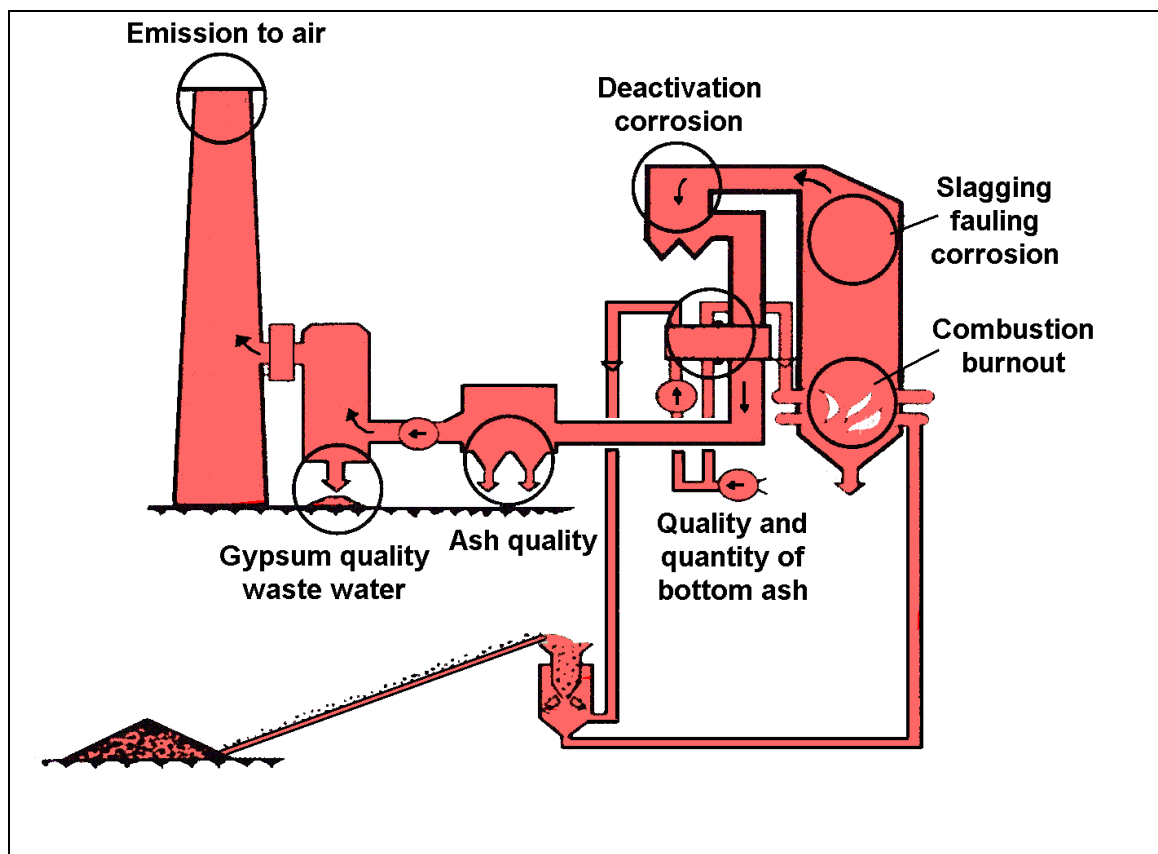

Figure 5.6: Influence of coal quality on the performance of the combustion plant

European operators generally monitor the fuel characteristics according to the frequency reported in Table 5.3, with the general qualitative rule of carrying out full analyses for each new fuel burnt or for each fuel delivery.

Table 5.3: Typical monitoring of fuel characteristics in European coal- and/or lignite-fired plants

Fuel characteristics	Typical monitoring frequency
Lower heating value	1/week (range from 1/day to 1/month)
Proximate analysis	
Moisture	1/week (range from 1/day to 1/month)
Volatiles	
Ash	
Fixed carbon	
Ultimate analysis (dry basis)	
C	1/month (range from 1/year to 3/day)
H	
N	
Total S	
O	
Cl	
F	
Br	6/year (range from 0/year to 1/day)
K	
Na	
Metals (Cd, Tl, Hg, Sb, As, Pb, Cr, Co, Cu, Mn, Ni, V, Zn)	4/year (range from 0/year to 1/week)
<i>Source: [3, LCP TWG 2012]</i>	

5.1.1.2 Pretreatment and preparation of coal and lignite

Careful selection of the coal is an effective way of reducing emissions to air and water and of reducing residues generation. However, possible restrictions related to the worldwide coal market may limit the possibilities for switching coal. Low levels of sulphur, mercury and ash are preferred when using commercially supplied or imported coal as a fuel. It is advantageous to use fuels with a high energy content and which incur minimum transport and handling costs.

To achieve a constant fuel quality, which helps to optimise the combustion process, coal is sometimes blended or mixed, depending on the specification range of the combustion plant. This mixing can be simply achieved by picking coal from the stockpile in a different sequence from the unloading sequence or by blending different types of coal in silos between the coal yard and the raw-coal bunkers. In some cases it may be possible to blend fuels at the port of entry prior to transport to the power plant site.

Fuel blending or mixing may have different goals and effects as presented below.

Aim of a leaner fuel mix:

- drop in combustion chamber temperature (dry-bottom furnace);
- reduction in primary NO_x in flue-gas (less NH₃ consumption, longer operation period of SCR);
- reduction in CO content in combustion gas (less corrosion risk);
- reduction of unburnt carbon in fly ash (utilisation quality of fly ash);
- reduction in consumption of catalysts.

The effects of a leaner fuel mix:

- CO₂ content in flue-gas drops;
- flow of air and flue-gas increases;
- O₂ content in flue-gas rises;
- energy losses through flue-gas increases;
- energy consumption from fans, and specific CO₂ emission increase;
- efficiency decreases.

Aim of a richer fuel mix:

- increase in combustion chamber temperature (slag tap furnace, better ash extraction);
- increased efficiency.

The effects of a richer fuel mix:

- CO₂ content in flue-gas rises;
- flow of air and flue-gas drops;
- O₂ content in flue-gas decreases;
- energy losses through flue-gas drops;
- increase in unburnt carbon in fly ash;
- energy consumption from fans, and specific CO₂ emission decrease.

Qualifying conditions:

- CO content in combustion gas should not increase;
- no increase in unburnt carbon in fly ash;
- acceptable risk regarding higher corrosion or higher ash recirculation.

Aim independent of a lean or rich fuel mix:

- decrease of SO_x in flue-gas for plants without (or with low-efficiency) FGD, or

- increase of SO_x in flue-gas for efficient ESP operation (ash resistance).

Lignite is generally transferred from the lignite storage yard via belt conveyors (normally located under a roof) to the crusher house, where its size is reduced in hammer mills and two roller crushers to pieces of 80–40 mm or less. The crushed lignite is then transported via belt conveyors to the boiler bunkers. There are normally from six to eight bunkers to each boiler. The lignite moisture at this stage is 30–70 %, so only insignificant amounts of lignite dust are emitted during transportation and crushing, except at the transfer points where, due to air draughts, lignite dust may be created, but this occurs only locally and even then only to a limited extent. In order to ensure healthy working conditions in the bunker house, crusher house, and with the lignite handling systems, necessary measures are for example the installation of dedusting systems with air suction at the transfer points and at closed belt conveyors. The air is cleaned in bag filters to keep the dust concentration inside buildings below the maximum allowed concentration for working conditions.

Fuel preparation for pulverised coal combustion

Raw coal normally needs to be properly prepared for safe, economical and efficient use in a pulverised coal combustion system. In all coal pulverising systems, solid fuel is dried, ground, classified and then transported to the boilers.

To reduce the moisture content, the raw coal can be dried inside the coal mill. Pre-drying, whilst employed at some lignite or sub-bituminous coal-firing plants, is less common in coal-fired plants.

Many mills are designed to reject, or are not adversely affected by, small inorganic or metallic materials. However, a magnetic separator could also be installed in the raw coal conveyor system to remove larger metallic objects. If this is not done, these objects could damage the conveyors or the pulverised coal feeder, and could obstruct the coal flow.

A proper size selection of pulverised coal has significant effects on the operation and economics of the furnace system. Fine grinding is necessary to ensure a rapid ignition and complete combustion of coal/lignite for maximum efficiency and to minimise ash and particulate deposits on heat-exchanger surfaces. However, the level of fineness is dictated by the cost of the grinding and is frequently subject to trade-offs between grinding costs and operational and environmental benefits. Changes to the particle size distribution, and hence burning rate, for existing burners may also have an impact on NO_x emissions. Coal pulverisation is currently carried out in ball mills, bowl mills, impact mills, fan mills, or in roller and race mills.

Table 5.4: Types of mills using different coal qualities

Coal quality	Ball-race mills	Bowl mills	Ball mills
Low volatile anthracite			■
High volatile anthracite	■	■	■
Low volatile bituminous coal	■	■	■
High volatile bituminous coal	■	■	■

Source: [123, Eurelectric 2001]

Several methods of supplying and firing coal have been developed, including the direct-fired system or the storage (indirect) system. With the direct-firing system, pulverised coal is carried by the gas or airflow from the mill through transport pipes and distributed to the burners. With the indirect-firing system, the pulverised coal is discharged into a transport loop equipped with a high-flow fan. It first passes through a classifier, where the coarse particles are recirculated to the mill, and is then collected in cyclones feeding the storage bin. Dynamic classifiers are used to achieve optimum particle size distribution for vertically fired plants using low volatile semi-anthracite. Direct-firing schemes are generally most common in pulverised coal-fired plants.

Fuel preparation for pulverised lignite combustion

The lignite is fed from the bunkers through closed feeders to the lignite mills. The mills are specially designed (e.g. fan beater wheel type) for the type of local fuel utilised. They achieve three objectives: they pulverise, dry, and then distribute the fuel to the combustion chamber. Lignite pulverisation is aided by the presence of hot flue-gases, which are extracted from the upper part of the furnace through recirculation ducting. The lignite particles are typically reduced to less than 90 μm (approximately 60 % through a 70-mesh screen). The flue-gas heat reduces the lignite moisture content down from 30–70 % to 10–20 %, i.e. to the required level for optimum combustion conditions. Finally, the mixture of lignite dust, flue-gases and moisture is fed to the boiler burners. This mixture can also contain air and/or cold flue-gas, when fed to the mills for mill temperature control.

For high moisture lignite one separator is built in the pulverised fuel discharge duct, where moisture vapour is separated and directed to vapour burner; a pulverisation beater wheel mill type is used.

Fuel preparation for fluidised bed combustion (FBC)

Fluidised bed combustion needs most solid fuels to be crushed. Depending on the fuel properties, maximum grain sizes of between 3 mm and 20 mm are desired. The prepared fuel is transferred directly to the fluidised bed in the combustion chamber, where the average bed particle size is 1 000 μm for bubbling fluidised bed combustion (BFBC), and 100–1 000 μm for circulating fluidised bed combustion (CFBC).

Fuel preparation for grate firing (GF)

If combustion is to be carried out on grates, then normally there is only limited fuel preparation needed. Large pieces of solid fuel may be reduced in size in order to supply a more or less homogeneous particle size distribution into the combustion chamber for burning on the grate. The maximum size of the fuel particles is often determined by the feed systems for the combustion chamber and depending on the technical conditions of the grate.

Fuel preparation for mercury removal

Coal cleaning is one option for removing mercury from the fuel prior to combustion. There are many types of cleaning processes, all based on the principle that coal is less dense than the pyritic sulphur, rock, clay, or other ash-producing impurities that are mixed or embedded in it.

5.1.1.3 Energy efficiency of coal- and/or lignite-fired LCP boilers

For a new boiler, design boiler energy efficiency levels around 85–95 % (LHV) are currently recorded for solid fuels. The main losses are associated with flue-gas waste heat via the stack, unburnt carbon, waste heat in ash, and radiation losses. The effect of fuel is important, assuming boilers with identical performance (same ambient and flue-gas temperature, same excess air, etc.), different boiler energy efficiencies are obtained depending on the nature of fuel, e.g. (LHV basis):

- international bituminous coal: up to 95 % efficiency;
- lignite: 91 % efficiency;
- low-grade lignite: 85 % efficiency.

Techniques to increase the energy efficiency of coal- and/or lignite-fired boilers

The energy efficiency of a coal- and/or lignite-fired boiler is closely linked with the nature of the fuel and the temperature of the ambient air. However, optimisation of some parameters is possible:

- **Unburnt carbon-in-ash.** Optimisation of combustion leads to less unburnt carbon-in-ash. It should be noted that NO_x abatement technologies by combustion modification show a tendency to increase unburnt carbon. The target is to achieve the best burnout in order to achieve the optimum efficiency or fuel utilisation. However, depending on technical and fuel characteristics, in particular by burning anthracite coal, a higher content of unburnt carbon-in-ash may occur.
- **Air excess.** The amount of excess air is dependent on the type of boiler and on the nature of the fuel. Typically, between 15 % and 20 % excess air is present in a pulverised coal-fired dry-bottom boiler. To preserve combustion quality (CO and unburnt carbon formation) and boiler integrity (air in-leakage), and to avoid corrosion and safety risks (risk of thermal excursions in the boiler), it is often not possible to reduce the excess air any further.
- **Flue-gas temperature.** The temperature of the flue-gas leaving the boiler (depending on fuel type) traditionally lies between 120 °C and 180 °C, so as to avoid the risk of acid corrosion by the condensation of sulphuric acid. In the case of lignite-fired plants, the corrosion effect may occur below 160 °C. Some designs incorporate a flue-gas heat recovery system for second stage preheating or condensate preheating to lower the flue-gas temperature even below 100 °C, but this requires special cladding or special materials for ducting, for heaters and for the stack.

5.1.1.4 Control of emissions to air from coal- and/or lignite-fired LCPs

To control NO_x emissions, special low-NO_x burners and/or other primary NO_x abatement techniques are used. If these measures are not sufficient, selective catalytic reduction (SCR) or selective non-catalytic reduction (SNCR) with urea or ammonia, or a combination of these techniques, can be used to remove NO_x from the flue-gas.

Flue-gas desulphurisation is typically performed with scrubbers fitted between the steam generator and the flue-gas stack. If fluidised bed combustion is used, desulphurisation is best achieved in the fluidised bed itself, e.g. by adding calcium carbonate into the bed. Another end-of-pipe desulphurisation system may in that case not be needed.

The oldest environmental protection measure applied at conventional combustion plants is the removal of ash and char particles from the flue-gas. The most widely used method to achieve this is the electrostatic precipitator (ESP). Bag filters are also frequently used.

5.1.1.4.1 Control of emissions from pulverised fuel combustion

Fuel pretreatment

As a first step to minimise the generation of emissions, the raw materials used as fuels can be improved, for instance by the following measures:

- using a mixture of different coals with different characteristics and from different countries;
- using high quality coals, with respect to high heating value, low water content, low ash content, low content of sulphur, mercury, chlorides and fluorides;
- applying coal washing/cleaning;

- applying coal gasification;
- homogenising the coal to ensure the standard quality of the final fuel before combustion.

Fuel switch/choice

A choice of, or switch to, fossil fuels with a lower content of potential pollution-generating compounds can lead to a significant reduction in pollution from combustion installations. This technique is widely applied. Fuel switching options are limited by some adaptability restrictions for specific combustion installations concerning the use of different fuels, and sometimes by long-term contracts between power-producing companies and fuel suppliers. In the case of lignite-fired power plants, the possibility of a fuel switch is also sometimes limited by the quality of the available fuel deposits in nearby lignite mines. In general, the adaptability depends on the burners installed, and usually a switch from one coal type to another one with a better environmental profile (i.e. low sulphur content and low volatile material) or from coal to heavy oil is often possible based on the burners installed. Switching from coal to gas, however, normally requires a change of burners and the modification of the heat exchangers. Any improvement in emission reduction depends on the characteristics of the initially used fuel and of the new type of fuel [132, Rentz et al. 1999]. However, possible adverse impacts of any new coal on emissions should be considered, e.g. poorer ESP performance due to reduced sulphur content or poorer low-NO_x burner performance with higher volatile coals.

Dust abatement

In pulverised coal combustion, the bulk of the ash is carried with the flue-gas out of the combustion chamber. Only a small quantity (< 20 %) is collected as bottom ash in dry-bottom boilers; 80 % of the ash leaves the furnace as fly ash and this fly ash must be collected in the dust reduction equipment, such as an ESP or bag filter.

In wet-bottom boilers, ash is liquefied by the high combustion temperature. This liquid ash flows with gravitational force to the slag tap. Even with a high velocity gas flow, most ash is extracted as slag. Fly ash is often recirculated for this type of furnace, to extract almost all the ash as slag.

Amongst dust removal techniques, the ESP is (by far) the most commonly used in Europe in combustion plants using coal or lignite. Bag filters are also relatively common. ESPs collect fly ash, generally in dry form, which can then be recycled for use in road-building or for manufacturing products such as cement and concrete or for opencast mine restoration purposes or, as a last solution, it can be landfilled. Fuels can be supplied from different sources in the world, and ESP techniques, including sometimes a high voltage intermittent energising system, are able to react to different fuel qualities, including those with a lower sulphur content. Further developments are connected with high voltage peaking, which allows reducing the electricity consumption of the ESP.

Cyclones are rarely used for dedusting in LCPs. Some plants with pre-extraction of dust using a cyclone upstream of the ESP are operated in Europe.

Abatement of SO_x emissions

For the reduction of SO_x emissions from coal- and/or lignite-fired combustion plants, almost all techniques described for the desulphurisation of flue-gases in Chapter 3 are currently applied. The specific technique used depends on a variety of plant- and site-specific factors, such as the location, the thermal capacity and the load factor of the particular plant, as well as on the fuel and ash quality.

Dry and semi-dry techniques are generally more commonly applied to smaller plants (< 100 MW_{th}), whereas the wet FGD is the dominant technique used in various applications in larger plants, i.e. over 300 MW_{th}. Absorber towers are designed as spray, packed or double loop towers. An example of a wet FGD plant using a spray tower applied to a large coal-fired plant in the UK is presented in Figure 5.7.

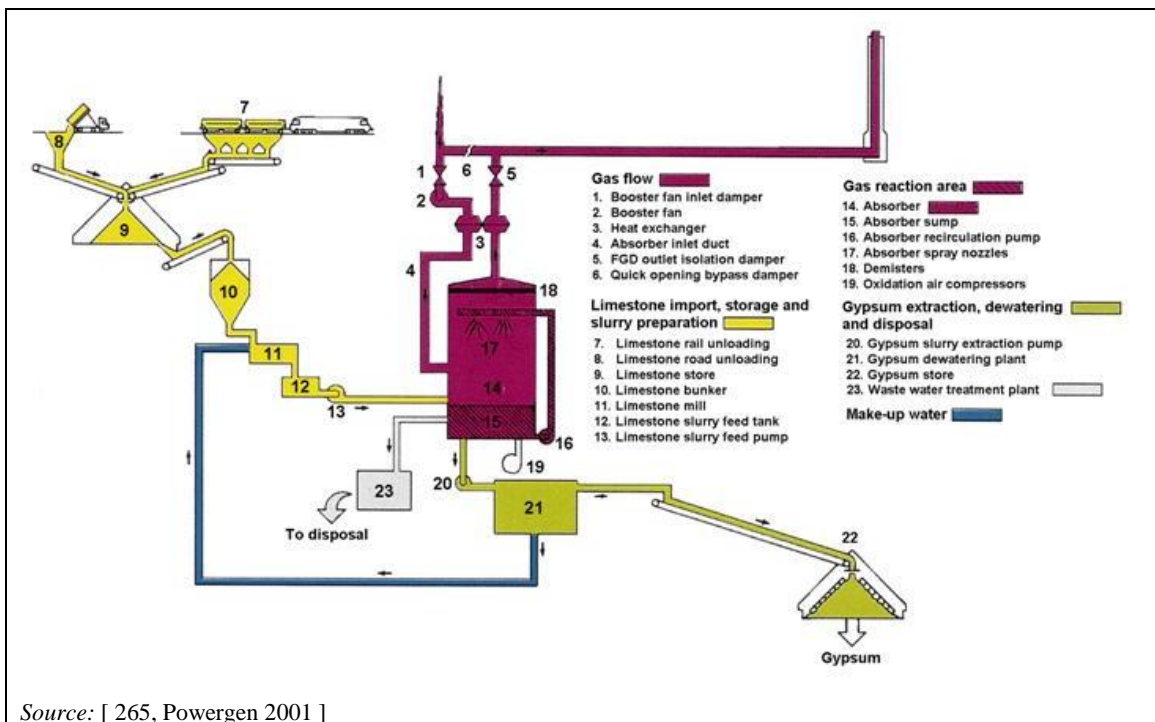

Figure 5.7: Wet FGD process with a spray tower

Because of the location constraints, only a few combustion plants in Europe situated close to the coast have applied seawater scrubbing systems to reduce SO_x emissions. One coal-fired combustion plant has successfully applied the combined DeSONO $_x$ process.

Abatement of NO_x emissions

As is the case for SO_x reduction, almost all the techniques described in Chapter 3 for the denitrification of flue-gases (i.e. primary and secondary techniques, and even in a few cases both types of techniques in combination) are currently applied in coal-fired boilers.

With lignite, since combustion temperatures are lower and the humidity of flue-gas is higher compared to coal, NO_x formation is comparably low. For this reason, only primary techniques have so far been applied to reduce NO_x emissions from lignite-fired LCPs in Europe. However, SCR has recently been installed in a limited number of lignite-fired plants in the US and a lignite-fired power plant using SCR is under construction in Slovenia.

Several techniques for NO_x abatement are described below.

Low excess air: this technique gives better results for wet-bottom boilers than for dry-bottom ones, for wall-fired boilers than for tangential-fired ones, and for coal-fired units than for lignite-fired units.

Flue-gas recirculation: this technique is not used very often in coal-fired boilers, except in wet-bottom boilers. For coal-fired boilers, the NO_x reduction obtained with this technique can be as high as 15–20%. This technique is only used in lignite-fired boilers by hot flue-gas recycling for lignite milling. In this case, the flue-gas is extracted for drying the lignite and is, therefore, not primarily used to reduce NO_x emissions but is still one of the reasons for the generally lower NO_x formation compared to coal furnaces. With additional cold flue-gas recirculation via the lignite milling systems, NO_x can be further reduced; additionally, slagging can be reduced for low temperature melting ash. This technique can also assist with the control of steam temperatures within the plant cycle.

Overfire air' (OFA): this technique is the most commonly used primary technique in coal-fired boilers, often in combination with a LNB. With modern OFA designs (optimised nozzle design, separated and swirled airflow), NO_x reductions of 40–50 % can be achieved in wall- or tangentially fired boilers. OFA is a particularly efficient NO_x reduction technique for tangentially fired boilers, where it can be implemented as 'close-coupled OFA' (i.e. with the addition of OFA ports just above the highest row of burners). Another option is 'separated OFA' (i.e. with the addition of OFA ports above the main combustion zone, separated from the burner rows). A recent development of this technique called either 'Boosted Overfire Air' (BOFA) or 'Rotating Opposed Fired Air staging' (ROFA) has been applied in the UK, Poland and other European countries at coal-fired plants. No references are available for lignite-fired and/or tangential-fired boilers. The technique uses an additional fan to increase the velocity of the OFA entering the furnace, thus allowing a greater degree of flexibility between NO_x reduction and char burnout.

Low-NO_x burners (LNBs): for coal-fired boilers, the most often used are air-staged or fuel-staged type burners, with NO_x emission reductions of 25–35 % and 50–60 % respectively. Low-NO_x burners are the most common technique used to reduce NO_x emissions in both new and existing coal-fired boilers, often in combination with OFA. It is a mature technology with many different designs currently available from worldwide suppliers, often specifically adapted to each type and size of boiler.

LNBs are often used in combination with OFA, especially with tangentially fired boilers, together with tilting or pulverised coal injectors and various OFA types.

Reburning in coal-fired boilers: this technique is implemented with coal – or far more commonly – natural gas as reburning fuel. Reburning is easier to apply to new power plants but it has also been successfully adapted to existing units.

Gas reburning has been implemented in several wall-, tangential-, or cyclone coal-fired boilers in the US (from 33 MW_e to 600 MW_e). The gas reburning technique has only been installed in units already equipped with low-NO_x burners and/or OFA.

An 'advanced gas reburn' technique (AGR), mixing regular gas reburning with injection of a nitrogen agent (ammonia or urea, see SNCR paragraph below for details), has also been installed in one coal-fired boiler. This promising technique has been claimed to achieve a NO_x reduction of up to 85 % from the initial NO_x level, but it is not yet a proven technique. Due in part to the performance levels achieved by BOFA/ROFA (see above), reburning has not been widely applied.

SNCR and SCR: these are secondary techniques that have largely been applied to coal-fired combustion plants. In Europe, SCR systems are mainly applied in Austria, Germany, Italy, Denmark, France, the Netherlands. Outside Europe, they are mostly applied in Japan and the US. The SCR technique has proven to be successful for coal-fired combustion plants, but has not yet been widely applied to lignite-fired plants. In a few cases where an SCR system has been applied to lignite-fired power plants, concerns regarding the deactivation and damage to the catalyst due to the characteristics of the ash were raised. However, SCR has been operated successfully at several lignite-fired units worldwide. The fuel characteristics dictate the catalyst and system design, and key issues for the design of SCR for lignite burning include its heterogeneous quality, its high ash content, its high silica or alumina content, its high S and Ca content and its high Na and K content. Lignite combustion is generally at a sufficiently low furnace temperature to achieve emissions of 200 mg/Nm³ or even lower, without the need for SCR when other primary techniques are applied and combined. NO_x emissions of 80 mg/Nm³ were achieved at a lignite-fired plant in the US that was recently retrofitted with SCR.

5.1.1.4.2 Control of emissions from fluidised bed combustion

For fluidised bed systems, fuel is used coarsely ground. In circulating fluidised bed combustion systems (CFBC), the bed zone is expanded by higher airflow velocities and ash (necessary for this type of combustion) has to be recirculated through a cyclone, which is an integral component of CFBC to recover coarse particles.

Dust abatement

For dust abatement from fluidised bed combustion (FBC) boilers, both ESPs and bag filters are currently applied.

Abatement of SO_x emissions

FBC boilers can achieve SO_x removal efficiencies of 80–90 % in BFBC boilers and more than 90–95 % in CFBC boilers, the abatement efficiency depending also on fuel sulphur content. Lime or limestone is added directly to the fuel and injected into the fluidised bed. These additives support the natural capability of alkaline ashes to capture SO_x. Good desulphurisation is achieved by adding limestone with a Ca/S ratio of 1.5 to 3.5. Besides the Ca/S ratio, the bed temperature also plays an important role in ensuring effective SO₂ reduction. Since the calcination process begins at around 700 °C and improves with higher temperatures, the most favourable combination of calcination and sulphation occurs at about 840 °C. This system is simple to operate, as the feeding of the sorbent and removal of the reaction product are incorporated into the combustion process.

To achieve more than 90 % SO_x absorption, the mass of calcium hydroxide in the bed must be in excess of stoichiometric conditions. This overdosing results in an increase of NO_x emissions, especially in CFBC boilers, because CaO catalyses the reactions of nitrogen compounds. However, the greatest increase does not take place until the SO_x concentration is very low.

Sorbent injection into the FBC boiler is an inexpensive method for sulphur capture. Investment costs are low, because the desulphurisation is incorporated into the combustion process and separate reactor equipment may not be needed. Secondary techniques for desulphurisation are not yet very common, but have already been used occasionally in a few FBC plants.

The largest operating expenses are due to the consumption of sorbent and the handling of combustion residues. The by-product of fluidised bed combustion is a mixture of ash, CaSO₄, unburnt fuel and unreacted sorbent. Relatively large amounts of sorbent are needed to achieve sufficient SO_x absorption; thus the volume of the solid waste from FBC is also large. Up until now, disposal in landfills has been the most common means of handling ash from the FBC boiler at power plants. Also, the ash can be used for construction purposes, such as in a road base or as a structural fill, provided there is not too much calcium in the ash.

An increased dust load may result in the need to enlarge the dust precipitator.

Abatement of NO_x emissions

The low combustion temperature (between 850 °C and 950 °C) of fluidised bed combustion systems is advantageous for the suppression of NO_x emissions. However, the FBC boilers may generate a significant proportion of nitrogen emissions as N₂O, which has a high global warming potential. Other techniques such as SNCR are applied in some plants. However, adding limestone to improve desulphurisation also promotes the conversion of NH₃ to NO_x through catalysis by unreacted lime. This means that the more lime (for SO_x control) is added to the fluidised bed, the more NO_x is formed.

Different types of fluidised bed combustion, usually BFBCs, are used in smaller capacity LCPs and tend to have higher NO_x emissions.

5.1.1.4.3 Control of emissions from grate firing

When burning coal or lignite in grate combustion systems, most of the ash is left on the grate and collected as bottom ash. Only a small quantity of ash leaves the furnace as fly ash and is collected in the dust reduction devices.

Dust abatement

For dust abatement from grate-fired combustion plants, both ESPs and bag filters are currently applied.

Abatement of SO_x emissions

For grate firing, which is mainly applied to smaller (< 100 MW_{th}) industrial combustion plants, low-sulphur fuel is mostly used for SO_x control. Because the combustion temperature varies between 850 °C and 950 °C, additives such as lime or limestone can also be added directly to the fuel for SO_x capture. These additives support the natural capability of alkaline ashes to capture SO_x. CaSO₃ becomes unstable at temperatures greater than 850 °C, and CaO and SO_x coexist in chemical balance. For this reason, grate combustion is not as effective for the abatement of SO_x emissions as fluidised bed combustion.

Abatement of NO_x emissions

The low combustion temperatures of grate systems are advantageous for the limitation of NO_x emissions. Grate systems (without additional control techniques) emit about 450 mg/Nm³ of NO_x, which is much less than from an uncontrolled Pulverised coal-burning combustion plant. Overfire air is also sometimes used in addition, to reduce the generation of NO_x emissions. SNCR may also be used on grate-fired systems, but may not be necessary due to the inherently low NO_x levels generated through this combustion process.

5.1.1.4.4 Control of mercury (Hg) emissions from coal- and/or lignite-fired LCPs

In most cases in Europe, no specific systems for Hg removal have been applied at combustion plants burning coal or lignite only. Indeed, bag filters and ESPs or wet scrubbers, which are designed for dust and SO_x, HCl and HF removal respectively, provide an additional side benefit by also removing Hg emissions.

It should also be noted that, in recent years, systems have been put in place for mercury control in many US plants including non-specific (like in Europe) and specific systems.

The abatement of Hg by non-specific flue-gas cleaning devices is based on Hg properties that are different depending on its speciation:

- Both gaseous elemental mercury (Hg⁰) and gaseous oxidised mercury (Hg²⁺) are in the vapour phase at flue-gas cleaning temperatures. Hg⁰ is hardly soluble in water and normally cannot be captured in wet scrubbers. The predominant Hg²⁺ compounds in coal flue-gas are weakly to strongly soluble, and the more soluble species can generally be captured in wet FGD scrubbers.
- Particle-bound mercury Hg_p is attached to solids that can be readily captured in an ESP or bag filter. [266, UNECE 2002]

Native capture (i.e. mercury capture without additional mercury-specific techniques such as activated carbon or sorbents) depends on the halide content in the coal and on the unburnt carbon content in the fly ash, both of which contribute to higher levels of oxidised and particulate mercury, which are easier to capture in existing air pollution control equipment than elemental mercury. The halide content in the fuel and the unburnt carbon content in the fly ash may be higher within bituminous coals than within sub-bituminous coals or within lignite.

The Hg removal efficiency of these non-specific techniques varies significantly depending upon the type of coal burnt and the specific control technique configuration. This is shown in Table 5.5, which displays the results of US field tests examining the co-benefit removal efficiency.

When using mercury-specific techniques, both Hg^0 and Hg^{2+} are partly adsorbed onto porous solids such as fly ash, powdered activated carbon, or calcium-based acid gas sorbents for subsequent collection in a dust control device. Alternatively, Hg may be captured in a packed carbon bed. Hg^{2+} is generally easier to capture by adsorption than Hg^0 .

Table 5.5: Example mercury removal efficiency for US coal-fired plants fitted with different combinations of techniques

System	Coal type B=Bituminous S=Sub-bituminous L=Lignite	Native capture (%)	Range of capture	Number of units tested	Effect on mercury capture
CS-ESP	B	29	0–63	4	Good capture of particulate- or sorbent-bound mercury; better native capture for bituminous coals than low rank coals
	S	3	0–18	3	
	L	0	0–2	1	
HS-ESP	B	11	0–48	3	Low native capture; probably requires specially formulated sorbents for high-temperature mercury capture
	S	0	0–27	4	
	L	None tested			
BF	B	89	84–93	2	Good co-benefit. Elemental mercury may be oxidised across the BF
	S	73	53–87	2	
	L	None tested			
CS-ESP + wet FGD	B	69	64–74	2	Good native capture for bituminous coals because of presence of soluble oxidised mercury in the flue-gas; relatively poor capture for low rank coals
	S	16	0–58	3	
	L	42	21–56	2	
HS-ESP + wet FGD	B	39	6–54	3	Moderate native capture for bituminous coals; poor native capture for low rank coals
	S	8	0–42	3	
	L	None tested			
BF + dry scrubber	B	None tested			Very high native capture expected for bituminous coals; less for low rank coals
	S				
	L				
BF + wet FGD	B	75	62–89	2	Good co-benefit capture for bituminous coals; elemental mercury may be oxidised across the BF and captured in the wet scrubber
	S	None tested			
	L	None tested			
SCR + CS-ESP	NA	NA	NA	NA	Good capture of particulate- or sorbent-bound mercury and better native capture for bituminous coals than low rank coals are expected
SCR + HS-ESP	NA	NA	NA	NA	Low native capture is expected
SCR + CS-ESP + wet FGD	NA	NA	NA	NA	Good capture of particulate- or sorbent-bound mercury; better native capture for bituminous coals than low rank coals; SCR will tend to enhance capture for bituminous coals by oxidising elemental mercury
SCR + Spray dryer + BF	B	97	94–99	2	Very high native capture for bituminous coals; less for low rank coals; SCR may enhance capture by oxidising elemental mercury
	S	23	0–47	3	
	L	17	0–96	2	
SCR + HS-ESP + wet FGD	NA	NA	NA	NA	Poor capture of particulate-bound mercury in general and total mercury for low rank coals; SCR may enhance capture for bituminous coals by oxidising elemental mercury
SCR + BF + wet FGD	NA	NA	NA	NA	High level of mercury capture would be expected for all coals. SCR may enhance capture for bituminous coals by oxidising elemental mercury

NB:
NA: Not available.
CS-ESP: Cold-side electrostatic precipitator.
HS-ESP: Hot-side electrostatic precipitator.
BF: Bag filter.
Wet FGD: Wet flue-gas desulphurisation.
SCR: Selective catalytic reduction.
Source: [56, Srivastava et al. 2006]

5.1.1.5 Water and waste water treatment

A variety of waste water types (see Chapter 1, Section 1.3.3) is generated from the operation of coal- and/or lignite-fired combustion plants. The techniques described for waste water treatment in Chapter 3 (Sections 3.1.10 and 3.2.4) are applied to a large extent for the purification of waste water from coal- and/or lignite-fired plants.

Managing the run-off water from coal/lignite yards, slag piles and by-product storage needs special attention. Before discharging surplus water, it is safeguarded by treatment and monitoring. Dilution, e.g. with fresh water, to meet the limits is not acceptable.

5.1.1.6 Treatment of combustion residues

When coal is burnt, most of the mineral matter is captured and removed as solid material at various places in the system, such as at coal mills, at the bottom of the boiler, in the economiser flue-gas cleaning system and in the stack. Bottom ash is recovered from all types of coal- and lignite-fired combustion plants, although the percentage of total ash it accounts for varies. Because of the recycling of fly ash in wet-bottom boilers, 100 % is recovered as slag tap granulate. Only when a certain amount of unburnt fuel remains in the fly ash is it recovered separately and stored in a special silo. With circulating fluidised bed combustion, a cyclone precipitator returns most of the ash to the furnace, where it agglomerates to bed material and is recovered as bottom ash.

With lime/limestone-based wet FGD systems, gypsum is recovered with a definite crystalline structure. This is necessary to separate gypsum from smaller undissolved limestone particulates and to dry the recovered gypsum. Excessively small particulates increase the humidity of this by-product, normally by about 10 %. When this by-product is washed, a high quality marketable product (comparable to or better than natural gypsum) can be achieved, with only trace impurities giving any indications of the fuel from which it is derived. Gypsum is usually stored in closed stockpile (see Figure 5.8). When FGD systems started being retrofitted, in some plants gypsum was further dried from 10 % down to 4 % or even 1 %, to reduce transport costs and to increase product quality.



Source: [330, UMWELT + TECHNIK 2000]

Figure 5.8: Closed gypsum storage facilities

In cases where there is no market potential for direct use, FGD gypsum can be stored separately outdoor in a controlled manner (without any fly ash or wet ash). FGD gypsum landfilling is

another option. It has been found that mixing FGD gypsum with fly ash and FGD waste water produces a mixture, often called 'stabilisate', which has better landfill properties than that of each component alone. These properties are: mechanical strength, permeability, and leachability.

The most usual management of the residues from lignite combustion is as restoration material in exhausted opencast mines, but they are still also disposed of in dumping sites, depending on their quality and composition. Fly ash is also very often used as a material for strengthening the overburdened slopes during the exploitation of lignite mines.

The 'stabilisate' has desirable properties because it combines the pozzolanic properties of the fly ash, as well as its potential for binding heavy metals and trace elements, with the properties of gypsum. No adverse environmental impacts are observed from the controlled landfills of LCP solid residues.

In general, combustion residues such as ashes and FGD by-products are collected at various points, such as the boiler, dedusting hoppers, ESPs, bag filters and FGD systems. These materials are transported by means of hydraulic or mechanical devices and stored in closed silos or in specially designed storage buildings, like those used for the storage of gypsum from the FGD systems.

Table 5.6 shows a summary of the possible reuse options for the residues from coal- and/or lignite-fired combustion plants. The most suitable option is determined on a case-by-case basis.

Table 5.6: Examples of marketing and removal of residues from coal and lignite combustion

	Fly ash		Bottom ash		Sorptions process products	Gypsum
	Lignite	Coal	Lignite	Coal		
Construction industry						
Concrete additive	x	x				
Lightweight aggregates for concrete	x	x	x	x		
Foam mortar, porous concrete	x	x			x	
High-performance concrete	x	x				
Blend additive in the cement industry	x	x				
Raw meal constituent in the cement industry	x	x				
Cement additive to delay setting					x	x
Isolation walls	x	x			x	
Construction gypsum						x
Ceramic industry	x	x	x	x	x	
Road-building and landscaping	x	x	x	x		
Dam construction with the RCC (roller-compacted concrete) technique	x	x	x	x		
Filler for bituminous surfacing, bonding layers and sub-base binders	x	x				
Ground stabilisation, loose building materials for earth work and road construction	x	x	x	x	x	
Soundproofing		x		x	x	
Landfill technology, waste treatment	x	x	x	x		
Landfill	x	x	x	x	x	
Hazardous substance immobilisation	x	x				
Lining material for landfill bottom lining	x	x			x	
Surface filter for landfill sealing			x	x		
Sewage sludge conditioning					x	
Base material for biological waste water cleaning			x	x		
Filler for pipeline ditches						
Stabilised ash cement mixture	x	x			x	
Ditch filling	x	x			x	
Other methods of utilisation	x	x	x	x		
Reclamation material in mining	x	x	x		x	
Zeolite production	x	x				
Alpha- and beta-half hydrate production						x
Filling material in the paper industry					x	x
Production of anhydrite					x	
Thermal recovery			x	x		
Flue-gas desulphurisation					x	

Source: [145, UBA AT 2000]

5.1.2 Current emission and consumption levels

This section provides information on currently observed (measured) emission levels to air from LCPs burning coal and/or lignite. Information is given about the fuels used in this sector, their chemical and physical properties and the ranges of impurities that can generally be expected. As far as available, the data include information about plant energy efficiencies and about any residues that may arise in the different operations, and also reflect any options for recycling and reuse of output streams within the whole process.

The extent of cross-media complexity is indicated where interdependency exists between various inputs and outputs, for example where different parameters are dealt with simultaneously or where some trade-off has been made such that certain levels cannot be achieved at the same time.

Performance data are qualified as far as possible by including details of operating conditions (e.g. equivalent full load factor), sampling and analytical methods, and on the statistical presentation of figures (e.g. averages, maxima, ranges). Actual performance data may be compared to relevant standards set in national or international legislation.

Current emission data in this document are normally reported as hourly, daily or yearly (when stated) averages. Dilution is not considered acceptable. The standard conditions of 273 K, 101.3 kPa, 6 % level of oxygen content, and dry gases are used.

5.1.2.1 Coal and lignite used in LCPs

Coal and lignite are currently the dominant solid LCP fuels in the EU. Figure 5.9 presents the lignite production, the coal production and imports in Europe in 2012.

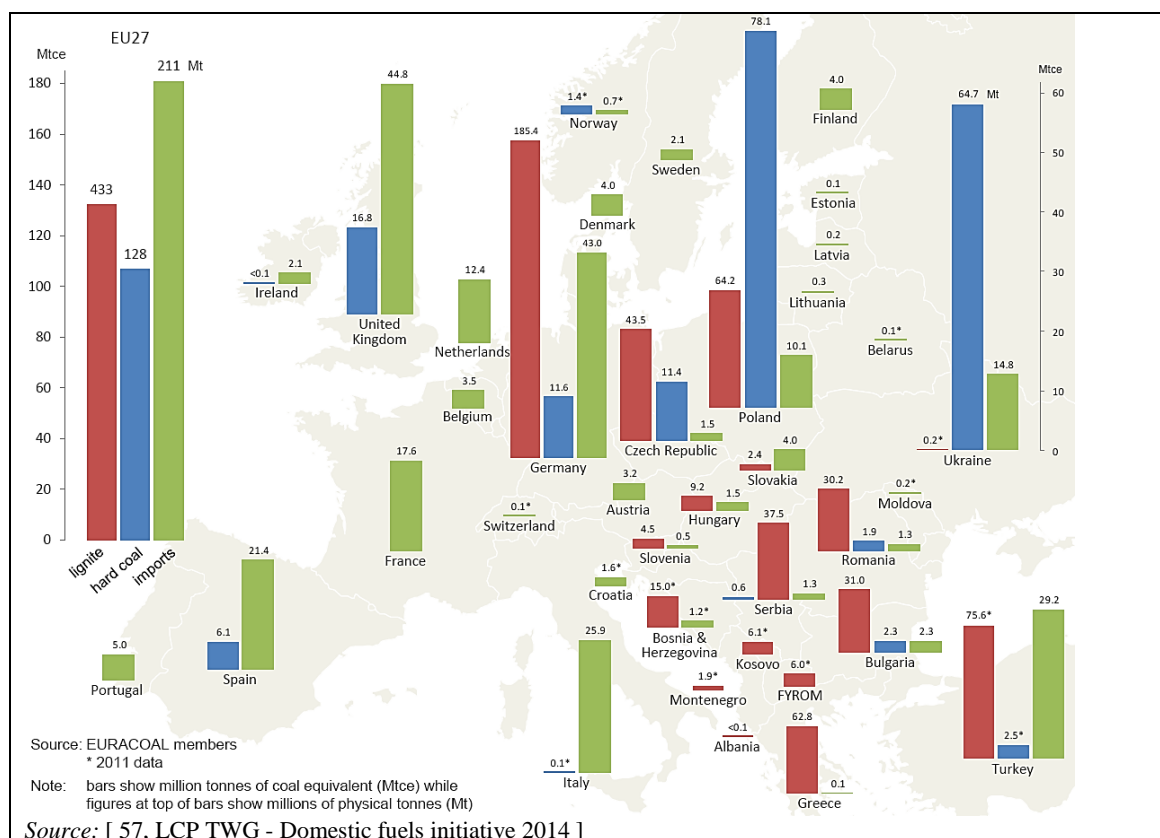

Figure 5.9: Coal in Europe in 2012 - Lignite production, coal production and imports

As shown in Figure 5.10, Germany is the largest source of lignite in the EU, producing about one third of the total output in 2000.

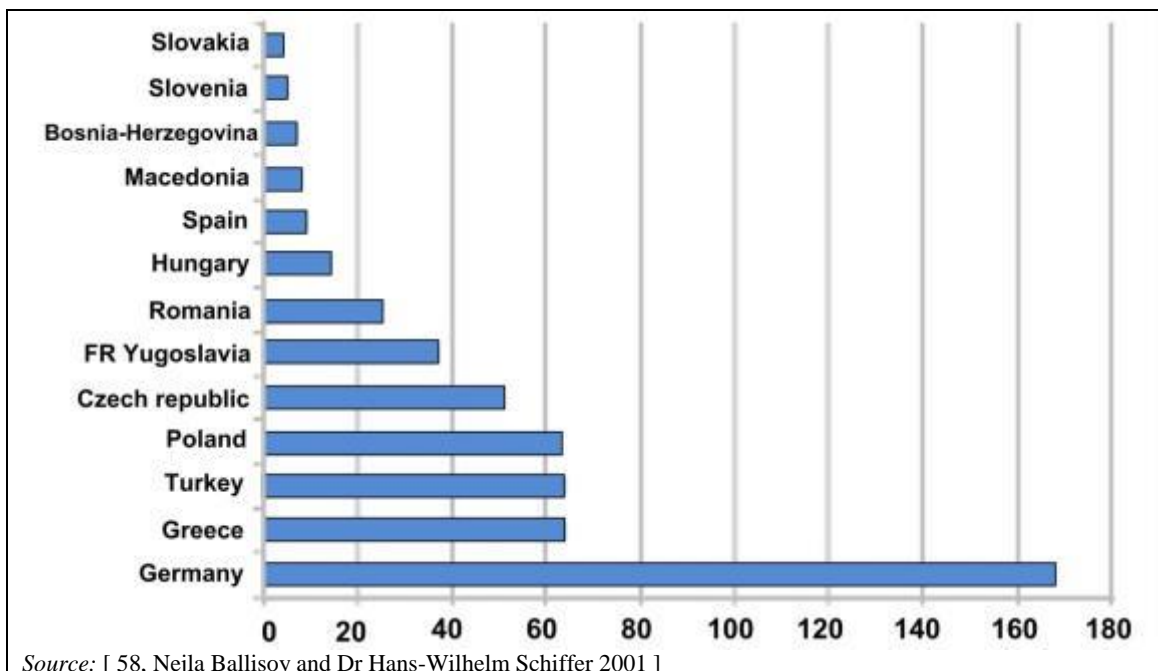

Figure 5.10: Europe's most important lignite mining countries, 2000 (in million tonnes)

Within this German dominance of EU lignite output, Rhineland lignite is the largest source, accounting for more than half of the German output in 2000 (Table 5.7). Table 5.8 gives the key characteristics of the German lignite.

Table 5.7: Output of German lignite in 2012 by region

Mining area	Output (million tonnes)	Output (%)
Rhineland	101.7	54.8
Lusatia	62.4	33.7
Central Germany	19.2	10.4
Helmstedt	2	1.1
Total	185.3	100.0

Source: [40, EEB 2012]

Table 5.8: Key characteristics of German lignite

Mining area	Rhineland	Lusatia	Central Germany	Helmstedt
LHV (kJ/kg)	7 800–10 500	7 800–9 500	9 000–11 300	8 500–11 500
Proximate analysis				
Moisture	50–60 %	48–58 %	49–53 %	40–50 %
Ash	1.5–8 %	2.5–16 %	6.5–10 %	5–20 %
Sulphur	0.15–0.5 %	0.3–1.5 %	1.5–2.1 %	1.5–3.5 %
Ash analysis				
SiO ₂	20–65 %	NA	NA	NA
Al ₂ O ₃	4–27 %	NA	NA	NA
CaO	2.5–22 %	NA	NA	NA
SO ₃	2.5–30 %	NA	NA	NA
NB: NA: Not available.				

Source: [40, EEB 2012] [59, DEBRIV 2011]

Figure 5.11 shows the sulphur and ash distribution in EU lignites, including from Germany, the Czech Republic, Greece, Poland, Bulgaria, Romania and Slovakia.

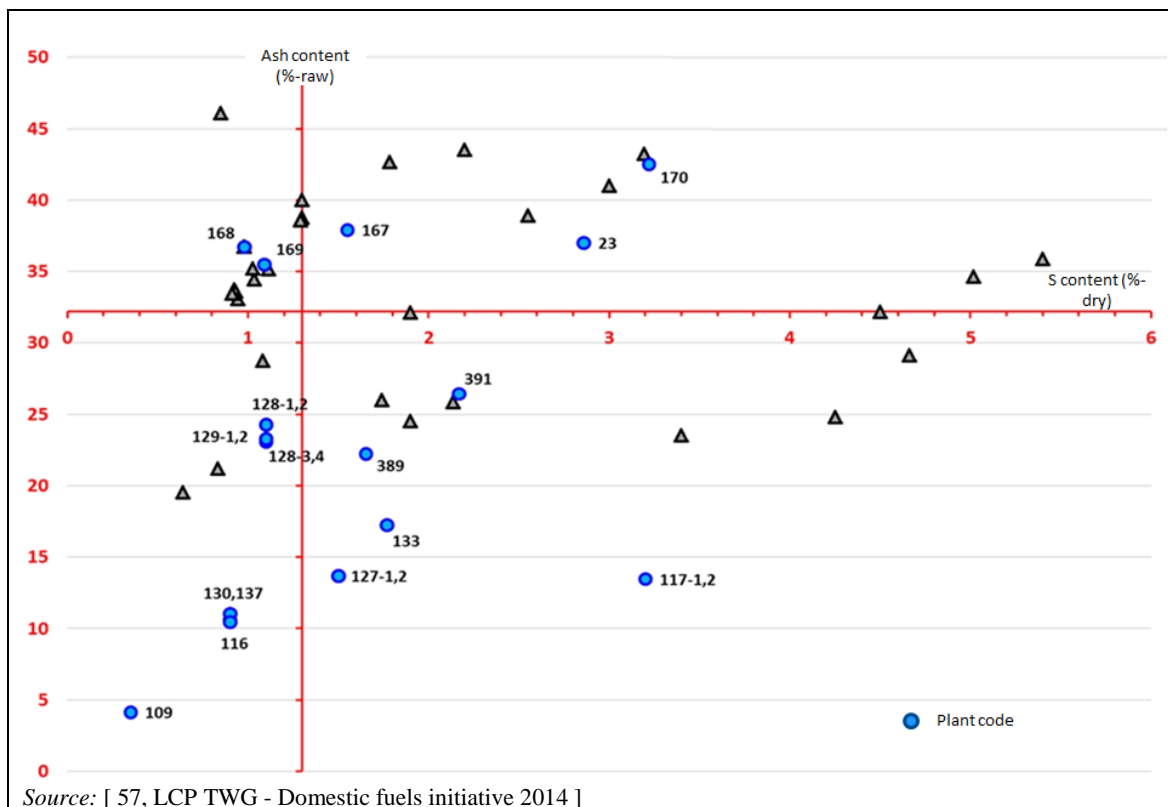

Figure 5.11: Sulphur and ash content in EU lignites ([wt-%], cross in medians)

Table 5.9 below shows the different contents of mercury in coals from different origins.

Table 5.9: Mercury content in coal from different origins

Origin	Number of samples (n)	Mean value of Hg content (mg/kg)		Variance v (%)
Indonesia	7	0.04	± 0.02	63
New Zealand	1	0.05	NA	NA
Colombia	7	0.06	± 0.03	57
Russia (Kuzbass)	1	0.06	NA	NA
Australia	17	0.08	± 0.06	70
Venezuela	2	0.08	NA	NA
South Africa	12	0.09	± 0.02	23
Blend	36	0.09	± 0.07	72
Egypt	1	0.10	NA	NA
Norway (Spitsbergen)	2	0.14	NA	NA
US (eastern)	15	0.14	± 0.12	84
China	2	0.15	NA	NA
Germany (Ruhr area)	1	0.16	NA	NA
Poland	10	0.35	± 0.55	154

NB:
NA: Not available.
Source: [123, Eurelectric 2001]

For more information regarding coal characteristics, see also Section 5.1.1.1.

5.1.2.2 Energy efficiency of coal- and lignite-fired combustion plants

Figure 5.12 and Figure 5.13 show the total design efficiency of coal-fired power plants in Europe in relation to their capacity and year of commissioning.

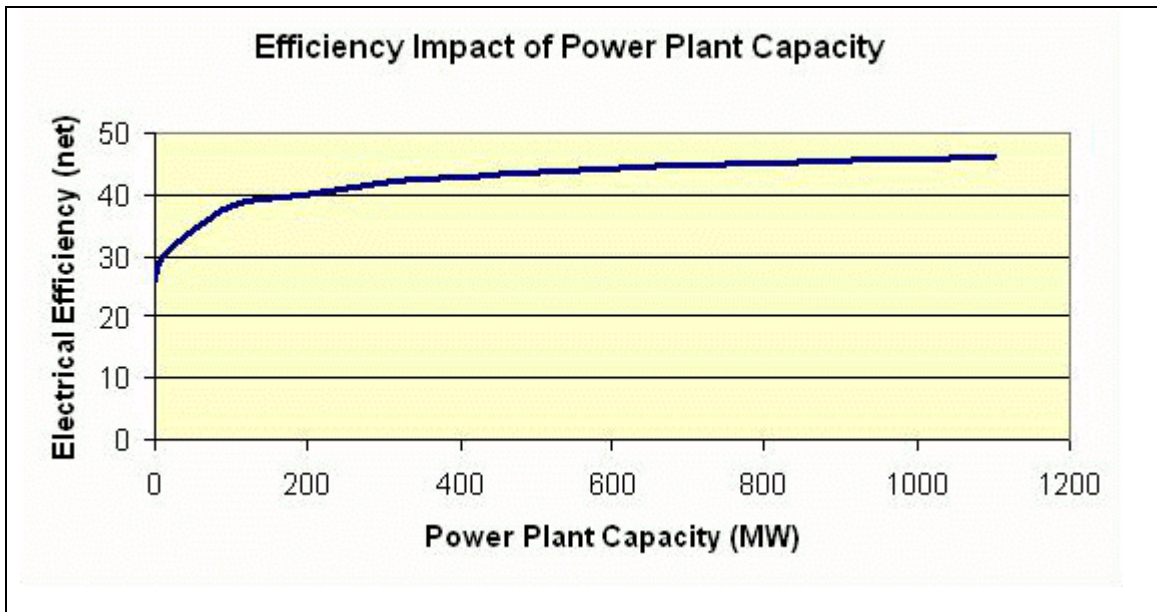
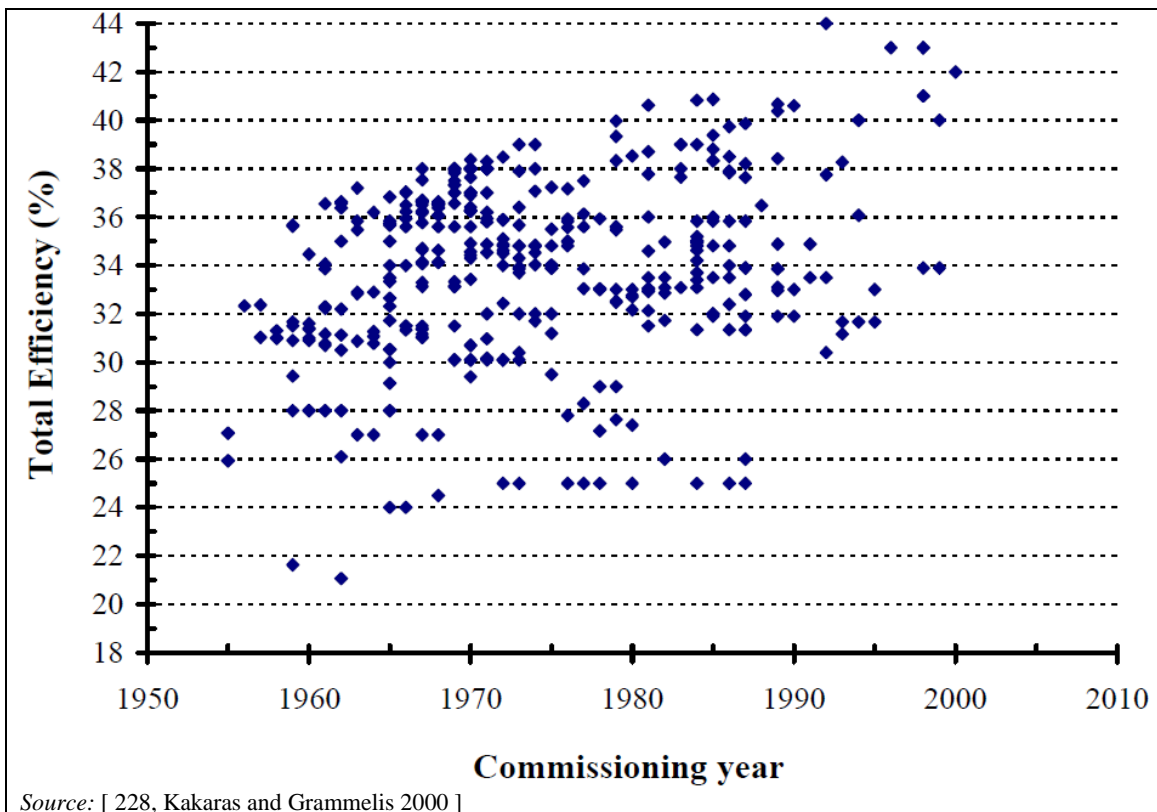

Figure 5.12: Efficiency impact of the power plant capacity (MW_{th}) based on design values



Source: [228, Kakaras and Grammelis 2000]

Figure 5.13: Efficiency of coal-fired power plants in Europe in relation to the commissioning year based on design values

Figure 5.14 and Figure 5.15 show the total yearly average efficiency of coal-fired power plants in Europe in relation to their capacity and year of commissioning.

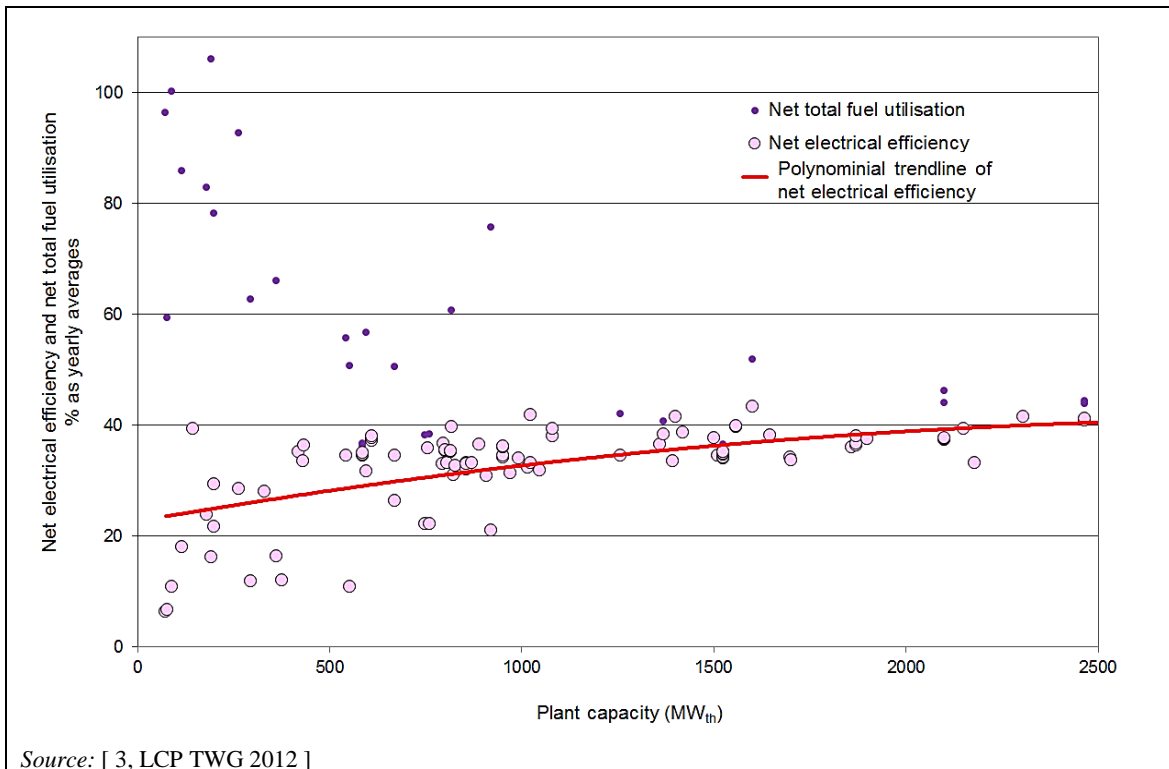

Figure 5.14: Efficiency impact of the power plant capacity based on operating yearly average energy efficiency values

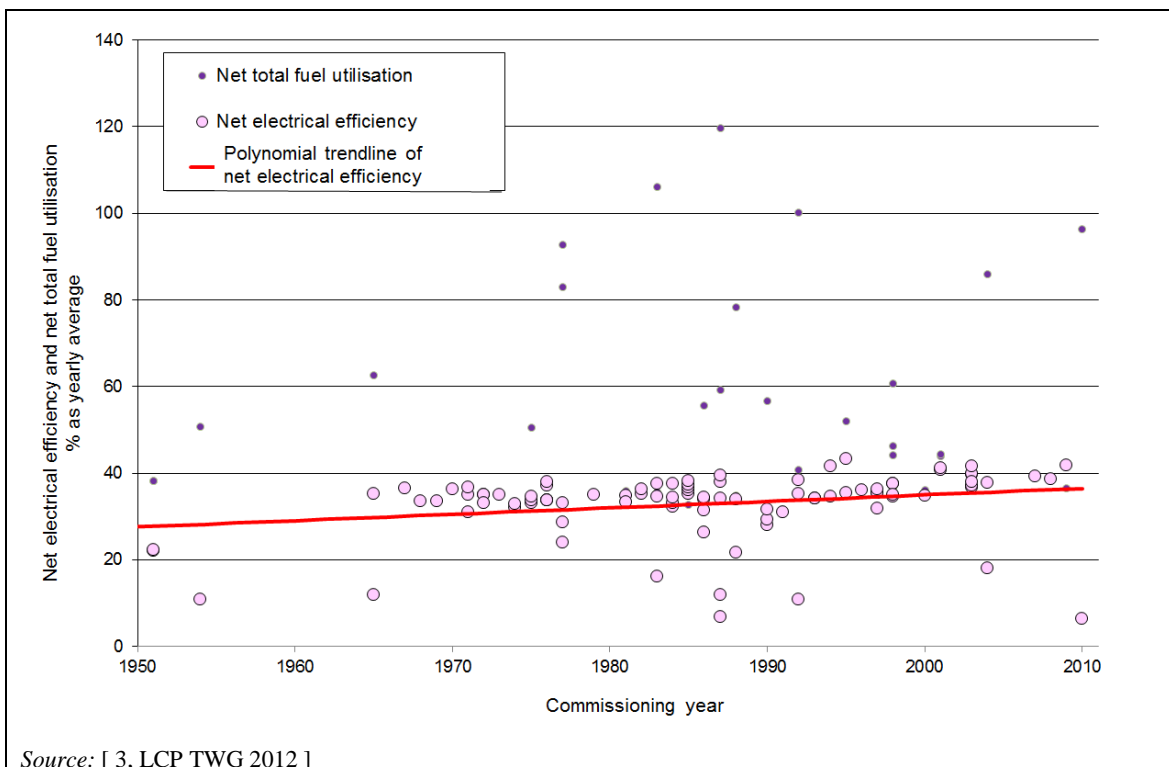

Figure 5.15: Efficiency of coal- and/or lignite-fired power plants in Europe in relation to the commissioning year based on operating yearly average energy efficiency values

Table 5.10 shows design energy efficiencies (LHV) for different types of well-performing LCPs burning different types of solid fuel.

Table 5.10: Typical design net electrical efficiencies (LHV) for different LCP technologies

LCP technology	PC	PC	PC	PC	PC	CFBC (retrofit)	IGCC
Electrical capacity	600 MW _e	750 MW _e	412 MW _e	375 MW _e	808 MW _e	250 MW _e	318 MW _e
Steam pressure	180 bar	260 bar	300 bar	190 bar	268 bar	163 bar	115 bar
Life steam temperature	540 °C	600 °C	580 °C	540 °C	547 °C	565 °C	507 °C
Reheater temp. I	540 °C	620 °C	580 °C	540 °C	550 °C	565 °C	-
Reheater temp. II	-	-	580 °C	-	-	-	-
Condenser pressure	33 mbar	39 mbar	21 mbar	61 mbar	40 mbar	44 mbar	70 mbar
Cooling system	Seawater	Cooling tower	Seawater	Cooling tower	Cooling tower	Cooling tower	Cooling tower
Type of fuel	Coal	Coal	Coal	Lignite ⁽¹⁾	Lignite	Lignite	Coal/Pet Coke
Net electrical efficiency (LHV)	41.2 %	45.5 %	47.5 %	37.5 %	40–43 %	38.8 %	42.5 %

⁽¹⁾ Lignite characteristics: 5440 MJ/kg - 14.6 % ash.
Sources: [1, Eurelectric 2012] [123, Eurelectric 2001]

Table 5.11 shows typical energy efficiencies (LHV) for different LCP technologies based on the same fuel (international coal HHV = 26 630 kJ/kg with 1 % sulphur, 7 % moisture and 16 % ash), with the same pollutant emissions (SO_x = 200 mg/Nm³ - O₂ = 6 %, NO_x = 200 mg/Nm³, dust 50 mg/Nm³) but for different steam cycles.

Table 5.11: Effect of the steam characteristics on design efficiencies for different combustion processes

Steam pressure/temperature/ condenser pressure	PC	AFBC	IGCC
165 bar, 2 x 565 °C, 45 mbar	38.5 %	38.0 %	44.5 %
165 bar, 2 x 565 °C with hot gas cleaning	NA	NA	47 %
250 bar, 2 x 565 °C, 45 mbar	42.0 %	41.5 %	NI
300 bar, 3 x 580 °C, 45 mbar	45.0 %	44.5 %	

NB:
PC: Pulverised combustion
AFBC: Atmospheric fluidised bed combustion
IGCC: Integrated gasification combined cycle
NA: Not available
NI: No information provided
Source: [123, Eurelectric 2001]

Information on the impact of individual measures and the material development to increase the efficiency of a coal-fired power plant is shown in Figure 5.16 and Figure 5.17.

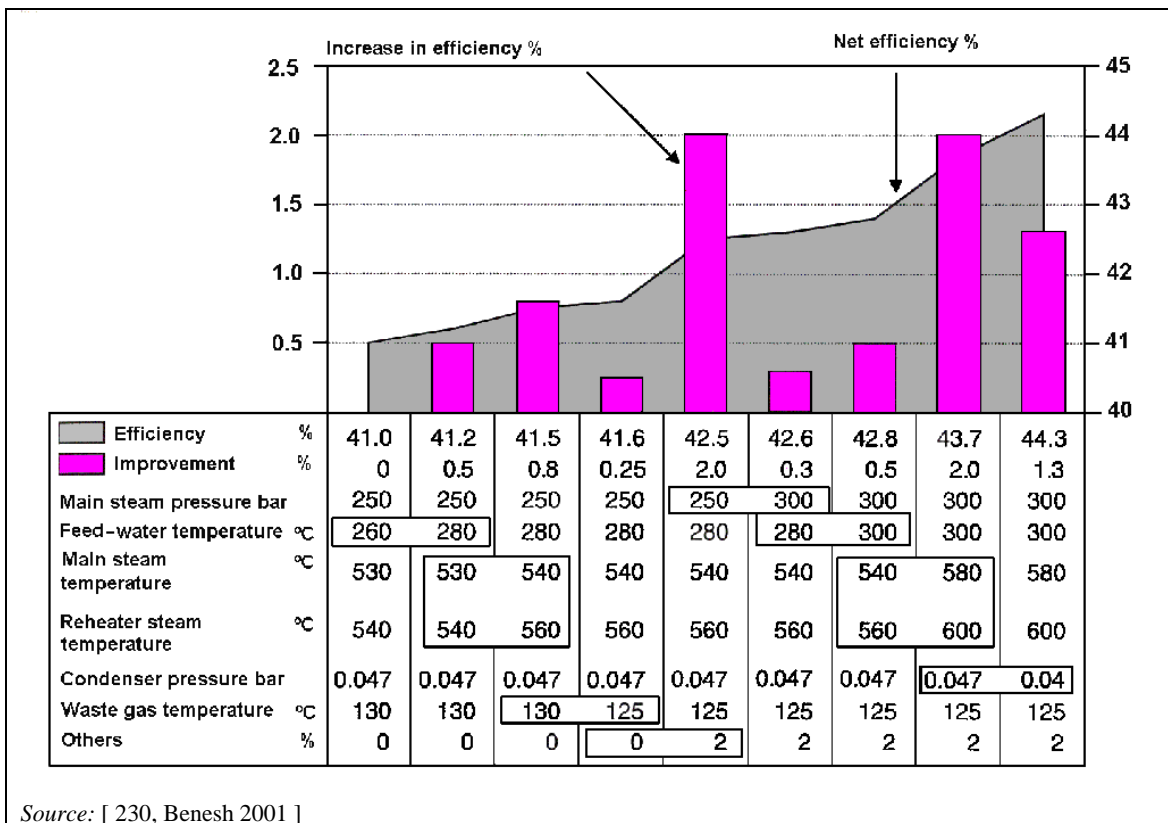

Source: [230, Benesh 2001]

Figure 5.16: Increased efficiency of a coal-fired power plant – individual measures

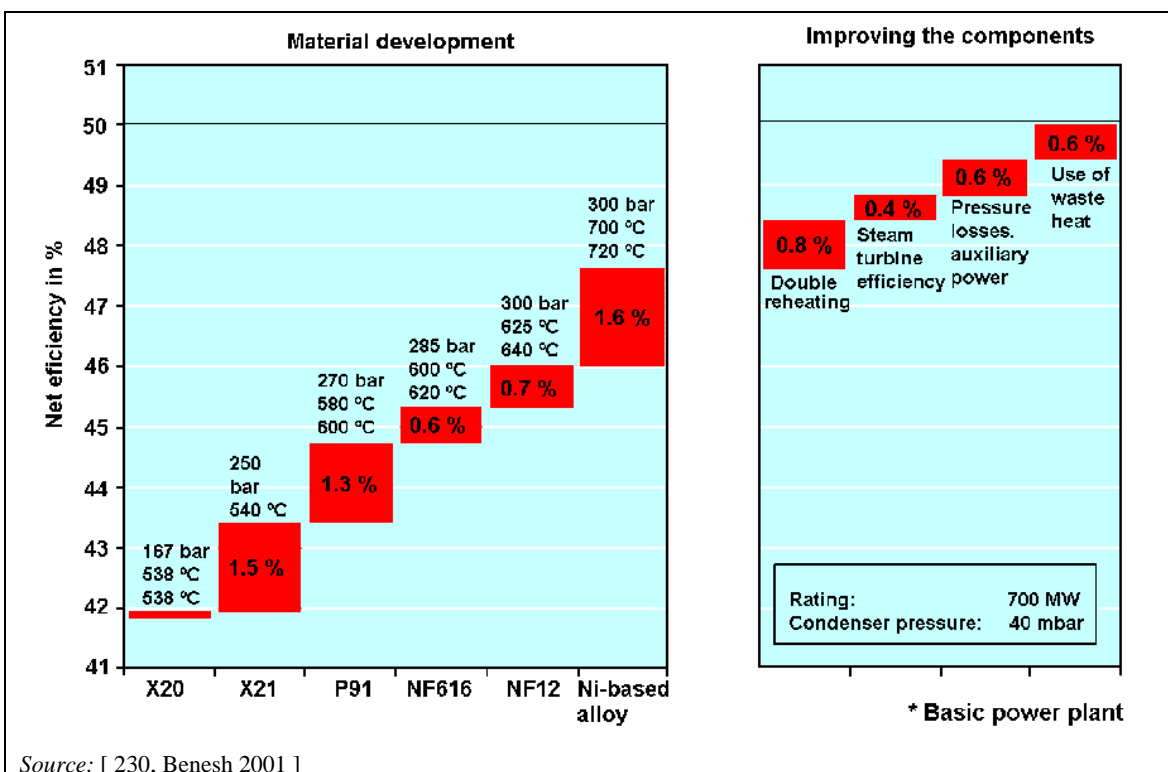

Source: [230, Benesh 2001]

Figure 5.17: Increased efficiency of a coal-fired power plant – development of materials

The figures show that the net efficiency of a power plant increases with the live steam temperature of the steam turbine process. For higher live steam temperatures, more expensive premium materials are necessary. On the other hand, it is possible to increase the efficiency of

the power plant components. The use of a double reheat cycle for example increases the net electrical efficiency by about 0.8 %. However, many standardised steam turbine sets are not adapted for the implementation of a double reheat cycle. This can often result in a substantial increase in the investment costs for the steam turbine and so this technique may not be profitable at every site. [1, Eurelectric 2012]

Other aspects that influence LCP efficiency are the following:

- **The technology used:** an IGCC, for example, intrinsically consumes more auxiliary energy (for the air separation unit, gas treatment and compressor) than a conventional pulverised combustion boiler, even with flue-gas treatment, which consumes more than a mechanical or spreader stoker grate system.
- **The level of pollution control:** advanced FGD consumes more energy. Also, generally pollution control measures have a detrimental effect on efficiency (see Section 2.7.10.1).
- **The design of the auxiliaries:** boiler auxiliaries have to be over-dimensioned to withstand all the variations in parameters compared to their design values (i.e. for possible leaks, alternative fuels, start-up needs, redundant systems, etc.). This leads to changes in energy consumption compared to that expected under optimal conditions and with the design fuel.
- **The integration of a CCS plant:** this energy-consuming process reduces the net electrical efficiency by about 8–12 percentage points.
- **The pre-drying of lignite:** this reduces the flue-gas losses substantially. In general, a net electrical efficiency enhancement of 4–6 percentage points is possible. The first pilot plants are in operation. Commercial pre-drying plants for lignite are expected after 2015.
[1, Eurelectric 2012] [60, Lecomte 2014]

- **Boiler efficiency:** for a new boiler, an efficiency level of around 86–95 % (LHV) is currently recorded for solid fuel and cannot easily be increased. The main losses stem from flue-gas waste heat at the stack, unburnt carbon-in-ash, waste heat, and from heat radiation losses. The effect of fuel is also important. Even assuming that the boilers have identical performances (i.e. same ambient and flue-gas temperature, same excess air, etc.), different boiler efficiencies are still achieved and these depend on the fuel, e.g. (LHV basis):
 - international coal: 95 % efficiency;
 - lignite: 91 % efficiency;
 - low-grade lignite: 85 % efficiency.

5.1.2.3 Emissions to air (coal/lignite)

Table 5.12 and Table 5.13 summarise the available information on measured air emission levels (SO₂, NO_x, dust, CO, HF, HCl, and NH₃) of about 90 European coal and lignite combustion plants.

Emissions to air from coal-fired combustion plants

Table 5.12: Example of emissions (in concentration – yearly averages) to air from coal-fired combustion plants

Capacity (MW _{th})	Comb. Tech.	Example of applied emission reduction techniques			Emission ranges of pollutants to air from example European coal-fired plants (mg/Nm ³)						
		SO ₂	NO _x	Dust	SO ₂	NO _x	Dust	CO	HF	HCl	NH ₃
15–100	GF SS	SDA	FGR / Air staging / SNCR	ESP / BF	300–1 450	130–620	8–18	34–63	NA	0.5	6
	GF MG	NA	Air staging	ESP / Cyclones	1130–1 420	335–730	120–200	130–170	NA	NA	NA
	PC	NA	LNB / Air/Fuel staging	NA	600–1 500	154–320	11–193	37–105	10	7	NA
	AFBC	Boiler sorbent injection	NA	NA	195–500	180–470	1–18	9–83	1	0.5–16	AFBC
	PFBC			ESP	680–760	214–450	2	100–210	0.45	NA	NA
100–300	GF SS	NA	NA	NA	950	490	50	700	NA	NA	NA
	GF MG	DSI+BF	SNCR / FGR	Cyclones/ ESP	680–1 040	170–360	6–190	95–115	NA	NA	NA
	PC	SDA	LNB / Air staging / SCR	BF / ESP / ESP + SO ₃ injection	190–1 320	170–560	< 1–80	16–32	0.45–1	NA	< 0.5
	AFBC	Boiler sorbent injection / WFGD	SCR	BF	350–555	100–260	< 1–14	30–230	0.05	2–17	NA
> 300	PC	Low-S coal / WFGD / DSI / SDA / CFB dry scrubber	LNB / SCR/ (reburning gas-coal) / Air staging / FGR	ESP / BF+WFGD / ESP + SO ₃ injection / CFB dry scrubber	9–1 400	65–1 020	< 1–105	1–240	0.01–6	0.2–40	< 3.4
	AFBC	Boiler sorbent injection / DSI	Air staging / SNCR	ESP	170–590	100–310	2–12	32–145	NA	1	< 2.9
	PFBC	Boiler sorbent injection	NA	ESP	485	150	35	75	NA	NA	NA

NB:

GF SS: Grate firing - spreader stoker

PC: Pulverised coal combustion

PFBC: Pressurised fluidised bed combustion

DSI: Duct sorbent injection for desulphurisation

CFB: Circulating fluidised bed

Source: [3, LCP TWG 2012] [61, Commission 2006]

GF MG: Grate firing - moving grate

AFBC: Atmospheric fluidised bed combustion

WFGD: Wet flue-gas desulphurisation

ESP: Electrostatic precipitator

SCR: Selective catalytic reduction of NO_x

SDA: Spray dry absorber for desulphurisation

BF: Bag filter

SNCR: Selective non-catalytic reduction of NO_x

FGR: Flue-gas recirculation

NA: Not available

Emissions to air from lignite-fired combustion plants

Table 5.13: Example of emissions (in concentration – yearly averages) to air from lignite-fired combustion plants

Capacity (MW _{th})	Combustion process	Example of applied emission reduction techniques			Emission ranges of pollutants to air from example European lignite-fired plants (yearly averages - mg/Nm ³)							Remarks
		SO ₂	NO _x	Dust	SO ₂	NO _x	Dust	CO	HF	HCl	NH ₃	
15–100	AFBC	Boiler sorbent injection - Low S-fuel content	LNB - Air/Fuel staging - FGR	NA	190–1 000	180–340	12–45	8	NA	0.3	NA	
100–300	GF	NA	NA	NA	NA	NA	NA	NA	NA	NA	NA	
	PC	DSI	SNCR	BF	80	170	6	95	NA	NA	NA	
	AFBC	Limestone injection	Air staging	ESP	985	155	10–28	0.2–25	0.5	NA	NA	N ₂ O 26 mg/Nm ³
	PFBC		LNB		380	260	5	25	NA	NA	NA	
300–2000	PC	WFGD	Pm (LNB air/fuel staging, FGR)	WFGD+ ESP / ESP	21–825	120–424	< 1–35	1–150	0.1	0.3–4	NA	
	AFBC	Boiler sorbent injection	Air staging	ESP / BF	290–1 450	220–320	23–44	3–130	0.35–2.6	1.6–16	NA	
> 2000	PC	WFGD	LNB+Air staging	WFGD+ ESP	75–320	125–275	2–6	5–85	0.4	1–7	NA	
<p>NB: GF: Grate firing PFBC: Pressurised fluidised bed combustion DSI: Flue-gas desulphurisation by duct sorbent injection Pm(...): Primary measures to reduce NO_x FGR: Flue-gas recirculation Source: [3, LCP TWG 2012] [61, Commission 2006]</p> <p>PC: Pulverised lignite combustion WFGD: Wet flue-gas desulphurisation ESP: Electrostatic precipitator SCR: Selective catalytic reduction of NO_x LNB: Low-NO_x burners</p> <p>AFBC: Atmospheric fluidised bed combustion SDA: Flue-gas desulphurisation using a spray dry absorber BF: Bag filter SNCR: Selective non-catalytic reduction of NO_x NA: Not available</p>												

Table 5.14 gives emission concentrations at the boiler outlet of example coal- and lignite-fired plants.

Table 5.14: Level of NO_x emissions for existing plants without secondary techniques

		Coal without NO _x abatement (mg/Nm ³)	Coal with low-NO _x burner (mg/Nm ³)	Lignite without NO _x abatement (mg/Nm ³)	Lignite with primary techniques (mg/Nm ³)
DBB	Horizontal firing system	1 000–1 500	500–650	NA	NA
	Tangential firing system	600–900	400–650	400–700	200–500
	Vertical firing system	700–900	NA	NA	NA
	Downshot firing systems	Up to 2 000	1 000–1 200	NA	NA
WBB	Cyclone firing system	1 500–2 500	1 000–2 000	NA	NA
NB: NA: Not available. DBB: Dry-bottom boiler. WBB: Wet-bottom boiler. Source: [123, Eurelectric 2001] [62, UK-TWG 2012]					

Metal emissions

During combustion, metals become volatile in metallic form, as well as in the form of chlorides, oxides, sulphides, etc. A large proportion of these metals are condensed at temperatures of up to 300 °C and adsorbed onto the dust particles (fly ash).

It has been shown that systems designed for flue-gas dedusting and flue-gas desulphurisation can also remove most of the metals from the flue-gases, i.e. those that are not retained in the bottom ash or slag. Hence, particulate metal emissions in the scrubbed flue-gas are extremely low in combustion plants equipped with flue-gas cleaning systems.

Experiments at a coal-fired dry-bottom boiler to evaluate the effects of different loads and the combustion of different coals on the mass balance of metals gave the following results:

- To a great extent, the amount of gaseous emissions of mercury via the flue-gas depends on the chlorine and calcium content of the coal. Chlorine has two opposing effects. It increases the share of gaseous mercury but it also improves the separation of mercury in the wet FGD, as HgCl₂, which can easily be washed out. Calcium improves the separation of mercury in the ESP.
- The integration of metals into the boiler ash does not depend on the chemical composition of the coal.
- The integration of metals into the fly ash does not depend on the chemical composition of the coal, but it does depend on the load of the boiler, as the maximum level is reached at full load.

With IGCC plants, the low volatility, high boiling point metals are captured and effectively immobilised in the vitreous slag. Most higher volatility metals can be condensed and captured by syngas scrubbing.

Table 5.15 gives a summary of metal measurements taken at three coal-fired power plants which have applied an ESP and wet scrubber desulphurisation.

Table 5.15: Pathways of metals in three example coal-fired combustion plants

	Amount of metals in different process outflows (%)			Emission (¹)
	Removed with bottom ash and with fly ash from ESP	Removed with FGD end-product + filter cake of waste water treatment plant	Share released to the air via stack	Concentration in the emission ($\mu\text{g}/\text{Nm}^3$)
Arsenic (As)	97–98.7	0.5–1.0	0.3–2	0–5
Cadmium (Cd)	95.2–97.6	0–1.1	2.4–3.6 (²)	0–5
Chromium (Cr)	97.9–99.9	0–0.9	0.1–0.5	0–5
Mercury (Hg) (³)	72.5–82 (³)	0–16	5.1–13.6 (³)	0–5
Manganese (Mn)	98–99.8	0.1–1.7	0.1	0–5
Nickel (Ni)	98.4–99.8	0.2–1.4	0.1–0.4	0–5
Lead (Pb)	97.2–99.9	0–0.8	0.1–1.8	0–5
Vanadium (V)	98.4–99.0	0.9–1.3	0.2–0.3	0–5

(¹) The emissions are indicative values, including both gaseous and particulate emissions. With good particle removal, the concentrations of all metals in emissions are typically below or around $1 \mu\text{g}/\text{Nm}^3$.

(²) The emission of cadmium was higher in these measurements than generally reported in the literature.

(³) The removal efficiency of mercury was higher and the emission lower in these measurements than normally reported in the literature. In literature, it is reported that about 20–30 % of the mercury is released to the air and only about 30 – 40 % is removed with the ESP.

Source: [130, Finland 2000]

Table 5.16 below shows the metal contents in the flue-gas at the stack level from 27 European plants combusting coal and/or lignite and up to 6 % waste, sized between $74 \text{ MW}_{\text{th}}$ and $2465 \text{ MW}_{\text{th}}$. Most of the plants of $\geq 300 \text{ MW}_{\text{th}}$ are fitted with an ESP or bag filter and a wet FGD, and plants of $< 300 \text{ MW}_{\text{th}}$ are generally fitted only with an ESP or bag filter.

Table 5.16: Metals content in flue-gases at stack level from example European plants

Pollutants	Combustion plant type	Type of monitoring	Frequency of samples	Mean values ($\mu\text{g}/\text{m}^3$)
Sb+As+Pb+Cr+Co+Cu+Mn+Ni+V	$< 300 \text{ MW}_{\text{th}}$	Periodic monitoring for 5 plants	1/yr to 5/yr	2.1–540
	$\geq 300 \text{ MW}_{\text{th}}$	Periodic monitoring for 19 plants, estimation for 3 plants	1/yr to 9/yr	0.1–156
Cd+Tl	$< 300 \text{ MW}_{\text{th}}$	Periodic monitoring for 5 plants	1/yr to 5/yr	0.4–5.5
	$\geq 300 \text{ MW}_{\text{th}}$	Periodic monitoring for 12 plants, estimation for 5 plants	1/yr to 9/yr	< 0.1 –6

Source: [3, LCP TWG 2012]

Table 5.17 below shows the mercury content in the flue-gas at the stack level from 84 European plants combusting coal or lignite and sized between $25 \text{ MW}_{\text{th}}$ and $3\,800 \text{ MW}_{\text{th}}$. Most of the plants of $\geq 300 \text{ MW}_{\text{th}}$ are fitted with a combination of SCR, ESP or bag filter and wet FGD, but some plants are only fitted with an ESP or bag filter, and sometimes with dry FGD. Most of the plants of $< 300 \text{ MW}_{\text{th}}$ are fitted only with an ESP or bag filter.

Table 5.17: Mercury content in flue-gases at stack level from example European plants

Combustion plant type	Type of monitoring	Frequency of samples (periodic monitoring)	Minimum values of Hg content ($\mu\text{g}/\text{m}^3$)	Maximum values of Hg content ($\mu\text{g}/\text{m}^3$)	Mean values of Hg content ($\mu\text{g}/\text{m}^3$)
Coal-fired, < 300 MW _{th}	Periodic monitoring for 15 plants	1/yr to 5/yr	0.1–14	0.5–31.4	0.2–20
Coal-fired, \geq 300 MW _{th}	Continuous monitoring for 9 plants, periodic monitoring for 29 plants, estimation for 5 plants	1/yr to 41/yr	0.01–1.7	0.2–(>)107	0.15–107
Lignite-fired, < 300 MW _{th}	Periodic monitoring for 3 plants	1/yr	NA	NA	1–6.7
Lignite-fired, \geq 300 MW _{th}	Continuous monitoring for 4 plants, periodic monitoring for 16 plants, estimation for 3 plants	1/yr to 12/yr	(<)0.8–10.2	(>)0.8–50	0.8–26
NB: NA: Not available. Source: [3, LCP TWG 2012]					

Commercial deployments and 50 US DOE industry tests of sorbent injection systems have achieved on average 90 % reductions in mercury emissions. These systems are being used on 25 boilers at 14 coal-fired plants. The effectiveness of sorbent injection is largely affected by coal type and boiler configuration. A US EPA analysis of the best performers showed an average mercury emission reduction of nearly 96 % across all three primary coal ranks – bituminous, sub-bituminous and lignite. [2, EEB 2012]

N₂O emissions

Table 5.18 and Table 5.19 show emission levels of N₂O from different literature sources and from different examples of coal- and lignite-fired combustion plants.

Table 5.18: Measured N₂O emission levels taken from different literature sources

Fuel	Comb. Tech.	O ₂ (%)	N ₂ O (mg/Nm ³)					N ₂ O (kg/TJ)	
			Kremer 1994	KEMA 1993	VGB Power Tech 1994	IEACR 1993	Braun 1993	IACR 1993	Peter 2001
Coal	PC (DBB)	6	< 2	< 4 (Without staged combustion) < 0.4–1.2 (With staged combustion)	NA	1–20	NA	0.4–1.4	2–5
	PC (WBB)	6	3.8–9		4–10	NA	NA	0.4–1.4	2–5
	Grate firing	6	< 30		1–10	0.2–3	NA	0.4–1.4	2–5
	CFBC	7	4–20 (Partial load) 40–700 (Full load)	16–170 (790–940 °C)	30–160	60–140	50–120 (With peaks up to 380)	36–72	20–45
	BFBC	7	100–150 (Partial load) 140–480 (Full load)	NA	NA	NA	NA	NA	NA
Lignite	PC (DBB)	6	10–16	NA	13	1.5–6	NA	0.6–2.3	0.8–3.2
	Grate firing	6	< 30	NA		0.8–2.5	NA	NA	0.8–3.5
	FBC	7	< 30	NA	5–20	10–90	5–14 (With peaks up to 30)	11–45	3–8

NB:
PC (DBB): Pulverised combustion (dry-bottom boiler).
PC (WBB): Pulverised combustion (wet-bottom boiler).
CFBC: Circulating fluidised bed combustion.
BFBC: Bubbling fluidised bed combustion.
FBC: Fluidised bed combustion.
NA: Not available.
Source: [231, Rentz et al. 2001] [61, Commission 2006]

Table 5.19: N₂O emissions from example European circulating fluidised bed boilers

Plant number	Size (MW _{th})	Combusted fuel	Techniques for NO _x – N ₂ O	NO _x yearly average (mg/Nm ³ at 6 % O ₂)	N ₂ O emissions (mg/Nm ³ at 6 % O ₂)	Equivalent full load factor (%)
470V	50	80 % Biomass and Peat + 20 % animal by-products	FGR - SNCR	71	22	81.8
385V	400	90 % Coal + 10 % Biomass	Lighting up burners - Air staging / Planned retrofit for NO _x (Flue-gas recirculation - 10 %)	265	21.1	92.3
377V	380	91 % Sub-bituminous coal + 9 % Sludge	Air staging	149	119	86

NB:
FGR: Flue-gas recirculation. SNCR: Selective non-catalytic reduction.
Source: [3, LCP TWG 2012]

Figure 5.18 shows that N₂O emissions strongly depend on the unit load.

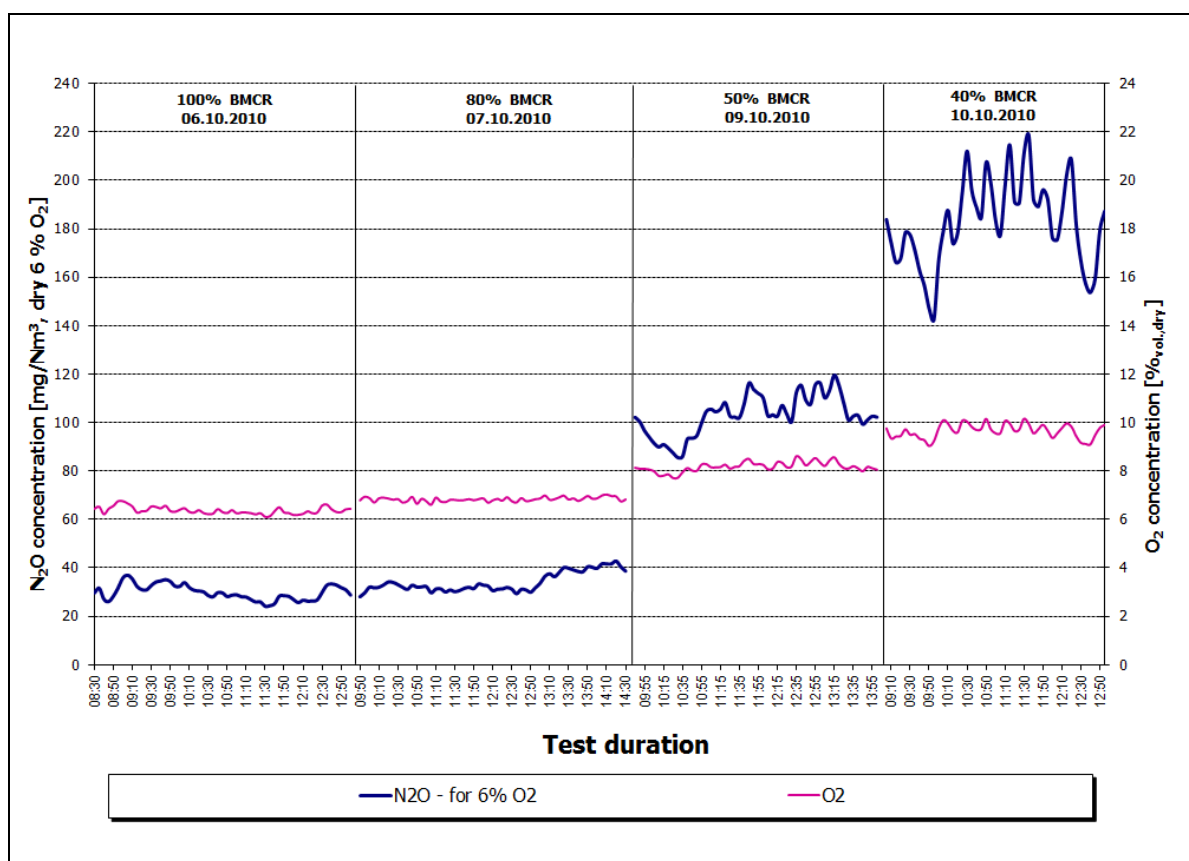

Figure 5.18: Impact of the equivalent full load factor on N₂O emissions at Plant 387 (Lagisza, PL)

Halide, dioxin and PAH emissions

Table 5.20 and Table 5.21 show typical emissions of HCl, HF, dioxins and PAHs from different coal and liquid fuel power stations.

Table 5.20: Example of HCl and HF emission levels from plants with and without secondary techniques

Fuel: coal	HCl mg/Nm ³ , 6 % O ₂	HF mg/Nm ³ , 6 % O ₂
No desulphurisation	100–450	4–28
FGD + contact transfer by regenerative air heater	3–14	2–8
FGD no transfer by air : air heater	1–8	0.2–2
FBC + dry lime addition*	1–380	0.5–8

* Higher SO₂ reduction increases emitted HCl part.
Source: [123, Eurelectric 2001] [3, LCP TWG 2012] [63, BDEW 2013]

Table 5.21: Example of dioxins and PAHs emission levels from the combustion of different fuels

Substance	Coal	Heavy oil	Orimulsion
Dioxins and furans	2.193 pg/Nm ³	2.492 pg/Nm ³	2.159 pg/Nm ³
PAHs	0.0606 µg/Nm ³	0.0507 µg/Nm ³	0.0283 µg/Nm ³

Source: [169, TWG 2006 LCP BREF 2003]

5.1.2.4 Combustion residues

Large quantities of mineral substances are generated in every power plant. For a 450 MW_e power plant burning one million tonnes of coal with for example an ash content of 13 % and a sulphur content of 1 %, some 187 000 tonnes of coal combustion products (CCPs) are yielded annually.

In 2010, nearly 780 million tonnes of coal ashes (bottom ash and fly ash) were generated worldwide. In many countries (for example, Austria and Canada) there is concern about the metal content of these residues, which may adversely affect their potential recycling or recovery.

The most common CCPs are:

Gypsum:

- **main component:** calcium sulphate dehydrate. The concentration of trace elements is limited by non-toxicity requirements.
- **critical parameters for use in the construction industry:** crystal size, crystallography and moisture content.
- the quality criteria for FGD gypsum are described by an industry standard agreed between Eurogypsum, ECOBA and VGB Power Tech e.V. [[83, EUROGYPSUM, VGB Powertec, ECOBA 2012](#)]

Fly ash: contains the largest part of condensed metal:

- critical parameters for use in concrete: ignition loss, Cl, free CaO;
- critical parameters for use in cement: physical, chemical, mechanical parameters of cement are specified (EN-197-1): ignition loss, sulphates, Cl.

Bottom ash: low metal content; use in the brick and cement industry.

Residue from spray dry absorption: mixture of gypsum, calcium sulphite and fly ash; the majority is landfilled or used as a sealing material for landfills.

Only combustion and flue-gas treatment-related residues are mentioned here. It should however be noted that waste water treatment (WWT)-related residues (e.g. sludges from FGD WWT) may also be, in many cases, of significant importance.

Figure 5.19 gives an example of volumes of CCPs generated by a typical power plant.

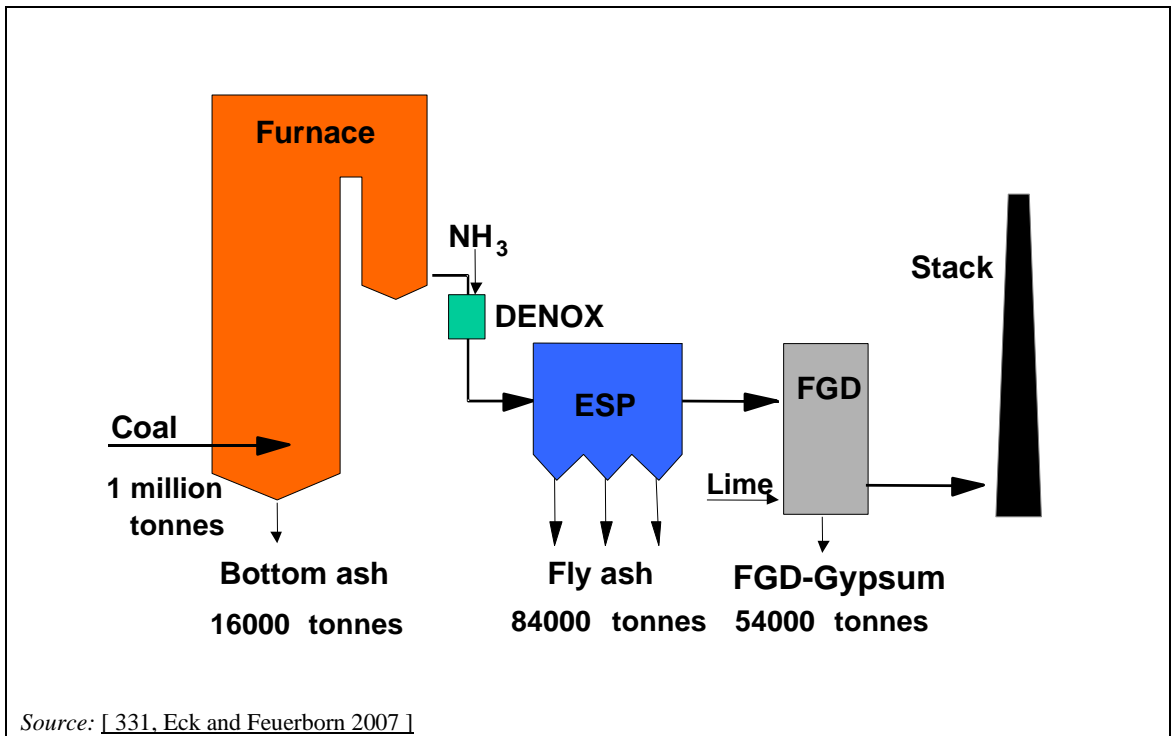

Figure 5.19: Annual production of CCPs in a 450 MW_e coal-fired power plant at 6 000 hours full load (total production of CCPs = 187 000 tonnes)

According to Ecoba [64, ECOBA 2010], the amount of CCPs generated in the EU-15 power plants totals 48 million tonnes, and totalled about 100 million tonnes in the EU-28 in 2011 when exact figures from all new Member States were not yet available to ECOBA.

Figure 5.20 shows the shares of the different CCPs generated in 2010. About 65 % of the total CCPs are generated as fly ash. All combustion residues add up to 78.8 % and FGD residues up to 21.2 % by mass.

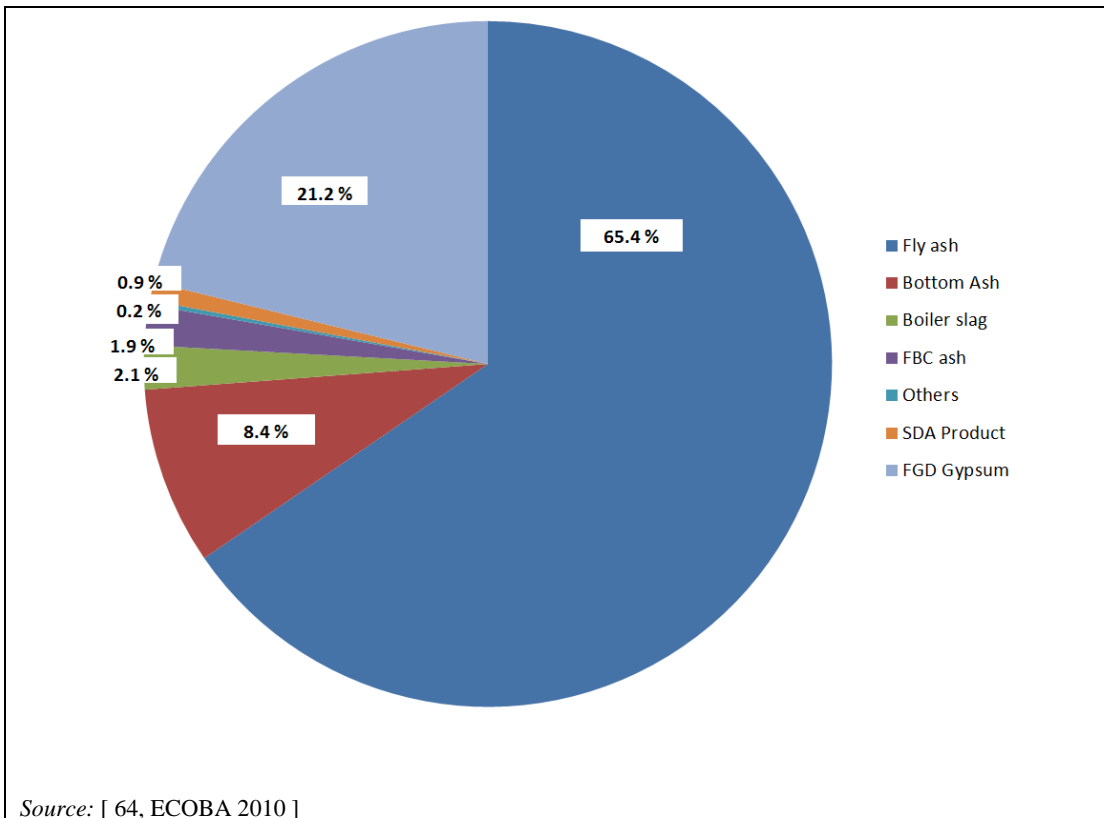

Figure 5.20: Production of CCPs in the EU-15 in 2010

Figure 5.26 gives an overview of the amount of CCPs generated between 1993 and 2010, and Table 5.22 details the share of each of them in the 2010 production year.

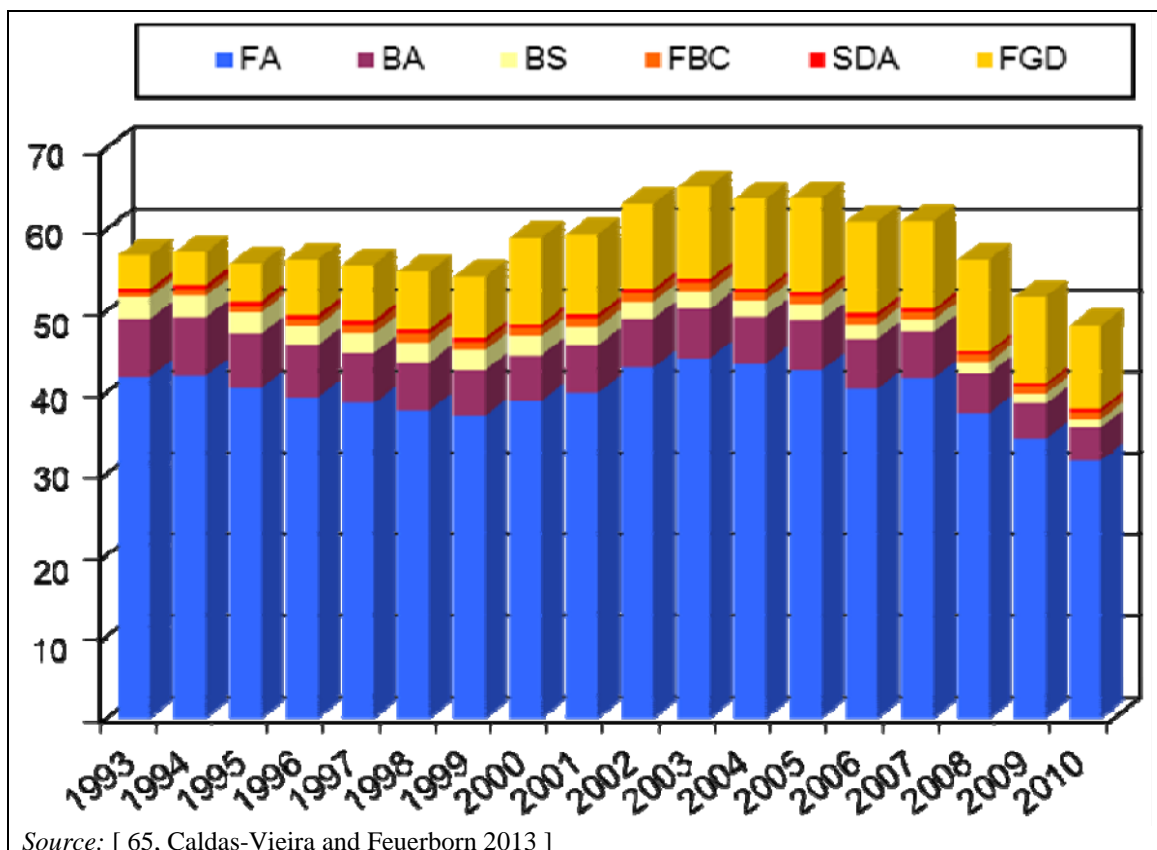

Figure 5.21: Development of CCP production in the EU-15 from 1993 to 2010

Table 5.22: Production of CCPs in the EU-15 in 2010

CCP production	Quantities (ktonnes)
Fly ash	31 616
Bottom ash	4 052
Boiler slag	1 000
FBC ash	912
Others	107
SDA residues	413
FGD gypsum	10 227
Total	48 327
<i>Source: [64, ECOBA 2010]</i>	

Most of the CCPs generated were used in the building industry, in civil engineering, and as construction materials in underground mining (51.7 %) or for the restoration of opencast mines, quarries and pits (39.8 %). In 2010, only 2.2 % was temporarily stockpiled for future use, and 7.1 % was disposed of (Figure 5.22).

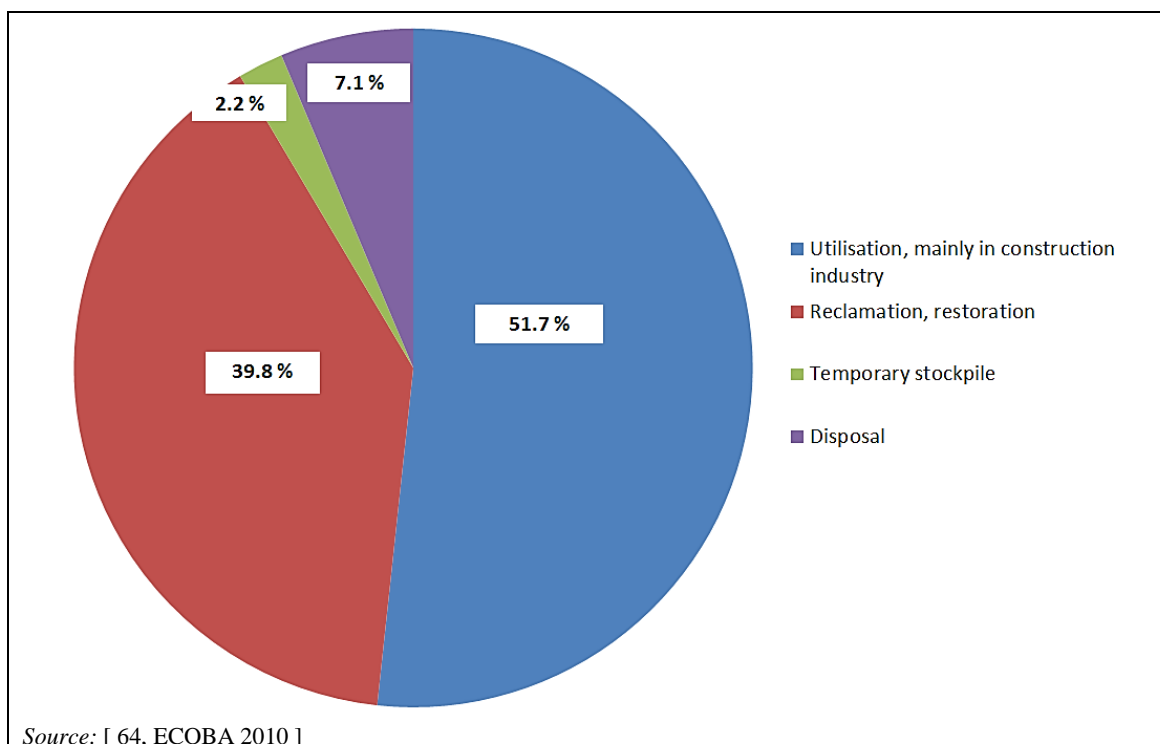

Figure 5.22: Utilisation and disposal of CCPs in the EU-15 in 2010

CCP utilisation varies between Member States, since climate, taxes and the legal situations also vary. In some EU countries, the utilisation rate for CCPs is nearly 100 %, whereas in other countries the utilisation rate does not exceed 10 %. This is also due to existing unfavourable properties/composition such as metal content, loss on ignition, free and total Ca content, Cl, etc. The utilisation of desulphurisation products also varies within the EU. In some countries, spray dry absorption (SDA) products are utilised in the construction industry and as fertiliser, in other countries they are disposed of. The FGD gypsum is utilised for the production of plasterboards and self-levelling floor screeds, as well as a retarder for cement. The observed development in utilisation rates is caused by a general acceptance of the materials as products. This

improvement has been achieved by research activities, practical experience, and by marketing efforts.

The rates for utilisation and disposal of different CCPs in 2007 are shown in Figure 5.23.

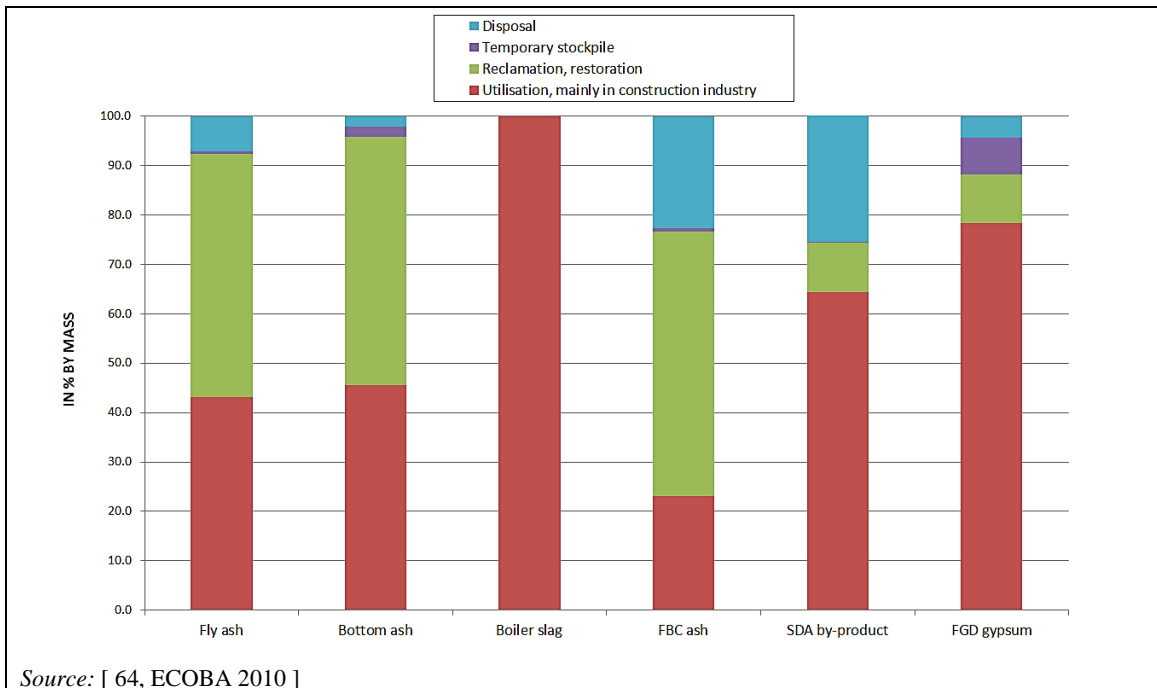

Figure 5.23: Utilisation and disposal of CCPs in the EU-15 in 2010

In 2010, more than 46 % of the combustion residues besides FBC ash were utilised in the construction industry and in underground mining. 100 % of the boiler slag was used in this area, whereas most of the FBC ash was used in the restoration of opencast mines, quarries and pits.

More than 60 % of SDA by-product and nearly 80 % of FGD gypsum were utilised in the construction industry and in underground mining. For the restoration of opencast mines, quarries, and pits 10 % of the SDA by-product and of FGD gypsum were used, and about 7.5 % of the FGD gypsum was stored in temporary stockpiles for future use. Only very small amounts of the CCPs had to be disposed of. [64, ECOBA 2010]

The metal content of some ashes and other combustion by-products are presented in Table 5.23 and Table 5.24. The data should be seen as examples because the variability is very highly dependent on the type of coal and installation.

Table 5.23: Metal content of coal and some coal combustion residues

Heavy metal	Concentration (ppm)			Mass stream (g/h)		
	Coal	Coarse ash	Fly ash	Coal	Coarse ash	Fly ash
Arsenic	10.8	12.0	43.9	3193.6	43.2	3042
Cadmium	0.07	0	0.295	20.7	0	20.4
Chromium	39.1	204.7	154.5	11 561.9	736.7	10 703.4
Copper	16.0	63.2	67.6	4716.4	227.5	4684.7
Lead	6.7	11.6	27.7	1981.2	41.8	1919.6
Mercury	0.28	0	0.1	81.3	0	6.9
Nickel	40.5	204.0	158.7	11 961.1	734.4	10 997.9
Selenium	0.99	0.6	1.4	291.3	2.2	97.0
Vanadium	41.3	94.7	169.0	12 197.6	340.9	11 711.7
Zinc	26.1	38.1	116.1	7717.8	137.0	8076.9

See also Table 5.1 and Table 5.2 on general characteristics
Source: [145, UBA AT 2000]

Table 5.24: Input and output of metals in some coal-fired combustion plants

Heavy metal	Input (%)		Output (%)				
	Coal	Chalk CaCO ₃	Fly ash	Coarse ash	Gypsum	Clean gas	Dust (emit.)
Arsenic	100.0	0.0	99.1	0.4	0.4	< 0.1	< 0.1
Cadmium	100.0	0.0	95.5	0.0	0.4	4.1	0.0
Chromium	99.6	0.4	91.2	5.1	3.6	0.1	0.0
Copper	98.9	1.1	94.3	3.6	0.8	1.4	< 0.1
Lead	99.6	0.4	98.0	1.1	0.4	0.5	< 0.1
Mercury	99.1	0.9	50.2	0.0	5.0	44.8	0.0
Nickel	97.3	2.7	88.7	10.8	0.2	0.1	0.2
Selenium	100.0	0.0	51.7	0.6	27.9	16.4	3.4
Vanadium	99.7	0.3	97.8	1.8	0.3	0.0	0.1
Zinc	99.5	0.5	97.7	0.8	0.6	0.8	< 0.1

NB: Output based on 100 % inputs of the metal element and chalk in relation to the output.
Source: [145, UBA AT 2000]

A study based on six typical power plants in China showed Hg concentrations in bottom ash ranging from 1 µg/kg to 16 µg/kg, concentrations of Hg in fly ash from the ESP hopper varying from 10 µg/kg to 295 µg/kg and a Hg content of gypsum ranging from 38 µg/kg to 561 µg/kg for a Hg content in the original coal varying from 17 µg/kg to 385 µg/kg. In addition, the Hg in fine ash from BF was 2945 µg/kg. [28, S.Wang et al. 2009]

5.1.3 Techniques to consider in the determination of BAT for the combustion of coal and/or lignite

This section describes techniques (or combinations thereof), and associated monitoring, considered to have the potential for achieving a high level of environmental protection in the activities within the scope of this document. The techniques described include both the technology used and the way in which the installations are designed, built, maintained, operated, and decommissioned.

It covers process-integrated techniques and end-of-pipe techniques. Waste prevention and management, including waste minimisation and recycling procedures, are also considered. Furthermore, techniques for reducing the consumption of raw materials, water, and energy are covered.

Annex III to the Industrial Emissions Directive lists a number of criteria for determining BAT, and the information within this chapter addresses these considerations. As far as possible, the standard structure of Table 3.4 is used to outline the information on each technique, to enable a comparison of techniques and the assessment against the definition of BAT given in the Industrial Emissions Directive.

This section does not necessarily provide an exhaustive list of techniques that could be applied in the sector. Other techniques may exist, or may be developed, which could be considered for the determination of BAT for an individual installation.

In this section, the techniques to be considered have only been fully described when they are specific to the considered combusted fuel or applied combustion process (combustion of coal and/or lignite). Indeed, for most of the techniques, general descriptions are already presented in Chapter 3. Therefore, in order to avoid repetition, for those general techniques already described in Chapter 3, only the additional information that is specific to the combustion of coal and/or lignite is reported here in synthesis tables.

5.1.3.1 Techniques to control diffuse emissions from the unloading, storage and handling of fuel/additives

Information on general techniques to reduce diffuse/fugitive air emissions is given in Section 2.8.

Table 5.25 gives additional information specific to lignite and/or coal firing.

Table 5.25: General techniques to be considered for the control of diffuse emissions from the unloading, storage and handling of fuel and additives

Technique	Description	Achieved environmental benefits	Environmental performance and operational data	Cross-media effects	Technical considerations relevant to applicability		Economics	Driving force for implementation	Example plants
					New plants	Existing plants			
Enclosed transfers	Closed transfer conveyors with depressurised systems where fuel is handled, and dedusting equipment	Reduction of fugitive dust emissions	High operational experience	None	Applicability depends on fuel moisture content	Applicability depends on fuel moisture content. Not applicable at the point of stacker – reclaimer systems	NA	NA	Plant 253
Wind shields	Open conveyors with wind shields			None	Generally applicable	NA	NA	NA	
Adjustable equipment	Unloading equipment with adjustable height			None	Generally applicable	NA	NA	NA	
Cleaning devices	Cleaning devices for conveyor belts			None	Applicability depends on fuel moisture content	NA	NA	NA	
Spray systems	Coal/lignite stored in open stockpiles is sprayed with water and chemical coating additives. Fog cannons are installed near open stockpiles			Water consumption and contamination	Not applicable to fuels with high surface moisture content	Cost for water spraying and drain water collection	NA	Plants 219, 221, 547	
Wind shields	NA			None	Generally applicable	NA	NA	NA	

Chapter 5

Sealed surface with drainage systems	Sealing of the whole storage surface may not be needed as long as the absence of potential leachate to the subsurface can be demonstrated and controlled	Prevention of soil and groundwater contamination	High operational experience	None	Generally applicable	Cost for waste water treatment	NA	NA
Enclosed storage	Enclosed storage of lime/limestone in silos with dust abatement	Reduction of fine particles		None	Generally applicable	NA	NA	NA
	Enclosed storage of coal	Reduction of fugitive dust emissions	NA	NA	Generally applicable		Local environmental quality standards	Plants 123, 253, 547
NB: NA: No relevant specific information available.								

5.1.3.2 Techniques to improve the general environmental performance

Information on general techniques to improve the general environmental performance of combustion plants is given in Section 3.1.1.

Table 5.26 gives additional information specific to lignite and/or coal firing.

Table 5.26: Techniques to be considered for improving the general environmental performance of coal- and/or lignite-fired plants

Technique	Description	Achieved environmental benefits	Environmental performance and operational data	Cross-media effects	Technical considerations relevant to applicability		Economics	Example plants
					New plants	Existing plants		
Fuel choice	Switching from the combustion of one fuel to a less harmful one in terms of emissions (low sulphur, low ash content or better ash quality) - see also Section 3.1.1.4	Better environmental profile, less emissions	High operational experience	Lower impurities in the coal leads to fewer emissions. Low ash content involves a PM emission reduction and a reduction of solid wastes for utilisation/disposal	Depends on the design characteristics of the specific boiler	Depends on the design characteristics of the specific boiler and configuration of the plant.	The fuel price might be higher	NA
Multi-fuel firing	Replacing part of the lignite or coal with another fuel such as biomass or syngas from biomass - see Chapter 8 and Chapter 4	Better environmental profile, less emissions	High operational experience for multi-fuel firing with biomass – Limited experience for multi-fuel firing with syngas	Potential increase in pollutants such as Cl to be considered	Generally applicable		May avoid costly end-of-pipe techniques	NA
Fuel blending and mixing	See also Section 5.1.3.4.3.1	Avoiding emission peaks, stable operation	High operational experience	NA	Generally applicable		Additional costs for fuel mixing and blending equipment	NA
					Best suited for boiler without secondary emission control			
Fuel cleaning	Coal washing, usually directly on the mining site - see also Section 5.1.3.4.3.1	Reduction of leachable impurities. Lower impurities in the coal leads to less emissions	High operational experience	Waste water from washing	Generally applicable		Additional cost of coal washing plant	NA

Coal gasification	See Chapter 4	Increased plant efficiency and lower emission levels particularly for NO _x	Limited experience. In the medium term, gasification has the potential to constitute a viable alternative to normal combustion, particularly in view of the expected electrical efficiencies of 51–55 %	NA	Applicable but until now only applied in a few plants	Not applicable	See Chapter 4	NA
Advanced control system	See Section 3.2.3.8	Increased efficiency, higher boiler performance, reduced emissions	High operational experience	None	Generally applicable	The applicability to old combustion plants may be constrained by the need to retrofit the combustion and/or control command system(s)	Plant-specific, e.g. capex about EUR 0.6 million and opex about EUR 60 000/yr for Plants 121 and 142 (price level 2010)	Plants 121, 142
Combustion optimisation	See Section 3.2.2.7.1	Reduction of NO _x , CO, NH ₃ , N ₂ O and unburnt carbon emissions in a balanced way	High operational experience	None	Generally applicable	There are technological limitations in the possibilities to improve the boiler design	NA	NA
Integrated combustion process	Ensure a high boiler efficiency and include primary techniques to reduce NO _x emissions, such as air and fuel staging, low-NO _x burners and/or reburning. See also Sections 3.1.1 and 3.2.3.8	Increased efficiency, higher boiler performance, reduced emissions	High operational experience	None	Generally applicable		NA	NA
NB: NA: No relevant specific information available.								

5.1.3.3 Techniques to increase energy efficiency and fuel utilisation

Information on general techniques to increase the energy efficiency of combustion plants is given in Section 3.2.3.

Table 5.27 and Table 5.28 give additional information specific to lignite and/or coal firing. Further details on related environmental performance and operational data are given after these tables.

Table 5.27: General techniques to be considered to increase energy efficiency and fuel utilisation

Technique	Description	Achieved environmental benefits	Environmental performance and operational data	Technical considerations relevant to applicability		Economics	Example plants
				New plants	Existing plants		
Cogeneration (CHP), including district heating 3.2.3.2	See Section 3.2.3.2	Increased fuel utilisation	High operational experience	Generally applicable. When locating a new project, existing steam and hot water needs have to be investigated	Very limited, depending on site-specific demands for heat loads	The fuel price might be higher	NA
IGCC (Integrated gasification combined cycle)	See Chapter 4	NA	Design net efficiencies from 39 % to 43.1 % (LHV basis). Net yearly electrical efficiency for ELCOGAS (Spain) of > 37 %	Generally applicable, though more complex to design/operate than a conventional condensing boiler: high level of integration between gasification unit and combustion plant may improve the environmental performance but lower the operational flexibility	Not applicable	More costly than a conventional condensing boiler. May become more economically viable in the event of an increase in the CO ₂ price	NA
Steam turbine and/or other component upgrades	See Section 3.2.3.13	Increased efficiency	High operational experience	Generally applicable	The applicability may be restricted by demand/steam conditions and/or limited plant lifetime	NA	Plants 131, 168
Advanced materials use	See Section 3.2.3.5	Increased efficiency	Practised in new plants	Generally applicable	Limited applicability	NA	NA
(Ultra-) Supercritical steam parameters	See Section 3.2.3.14	Increased efficiency	Practised in new plants	Only applicable to new units of $\geq 600 \text{ MW}_{\text{th}}$ operated > 4 000 h/yr. Not applicable when the purpose of the unit is to produce low steam temperatures and/or pressures in process industries. Not applicable to gas turbines and engines generating steam in CHP mode.	Very limited applicability	NA	Plants 34, 116, 117, 123, 127, 167, 253, 387, 391, 133, 547
Double reheat	See Section 3.2.3.6	Increased efficiency	Practised mainly in new plants	Generally applicable	Generally applicable	NA	NA
Boiler feed-water	See Section 3.2.3.7	Increased efficiency	Practised in new plants	Generally applicable	Applicability may be	NA	Plant 168

temperature increase			and some existing ones		limited due to constraints associated with the plant configuration and the amount of recoverable heat		
				Only applicable to steam circuits and not to hot boilers			
Fuel drying	See Section 3.2.3.18 and Section 11.4.1.1	Increased efficiency	Limited experience, as only applied at pilot plant. Increased efficiency of approximately 3–5 percentage points	Emerging		Additional cost of lignite dryers	NA
				The retrofit of existing plants may be restricted by the extra calorific value that can be obtained from the drying operation and by the limited retrofit possibilities offered by some boiler designs or plant configurations			NA
Dry bottom ash handling	See Section 3.2.5.2	Increased efficiency. Reduction of water usage	Practised at some new plants and some existing ones	There may be technical restrictions that prevent retrofitting to existing combustion plants		Plant-specific	Plants 142, 219, 221, 253
NB: NA: No relevant specific information available.							

Table 5.28: General techniques to be considered to increase energy efficiency

Technique	Technical description	Achieved environmental benefit	Environmental performance and operational data	Cross-media effects	Technical considerations relevant to applicability		Economics	Example plants
					New plants	Existing plants		
Air staging	Better repartition of the air used for the combustion - see Section 3.2.2.3.2	Increased efficiency and reduced NO _x and N ₂ O emissions	High operational experience	Can increase the tube failure risk and the amount of unburnt fuel	Generally applicable	Generally applicable	NA	NA
Reduction in flue-gas temperature	Reduce the flue-gas temperature upstream of FGD down to 80 °C - see Section 3.2.3.1	Increased efficiency. The extra heat can be used only as secondary heat	High operational experience	Corrosion: Exhaust gas temperature should be 10–20 °C above acid dew point. Blocking of air heater. Effective mists separation in FGD required to avoid SO ₃ carry-over.	Generally applicable	Generally applicable	NA	Plant 168
Cooling tower discharge	Air emission release through the cooling tower and not a dedicated stack - see Section 3.2.3.16	Reheating of flue-gas after the FGD plant is not necessary. No stack is needed	High operational experience	NA	Generally applicable	Applicability to be assessed on a case-by-case basis (e.g. availability of cooling tower location and construction materials)	No additional cost for construction and maintenance of a stack	Plants 116, 130, 137
Wet stack technique	See Section 3.2.3.17	NA	High operational experience	Visible plume	Generally applicable to new and existing units fitted with wet FGD		NA	Plants 122a, 122b
Various techniques	See Cooling BREF	NA	NA	NA	NA	NA	NA	Plant 168
NB: NA: No relevant specific information available.								

Environmental performance and operational data for energy efficiency

Figure 5.24 shows the operating electrical efficiencies and total fuel utilisation of some European coal- and/or lignite-fired plants of more than 1 000 MW_{th}, commissioned between 1967 and 2009, operated between 2 400 h/yr and 8 700 h/yr, with an equivalent full load factor above 60 %. Plants with a yearly electrical efficiency below 35 % are quite old (generally commissioned before 1985) or combust low-grade quality lignite (Plant 169V). Some plants are CHP plants fitted with condensing or condensing/extraction steam turbines. Their main purpose is, however, to produce electricity with a limited amount of additional heat.

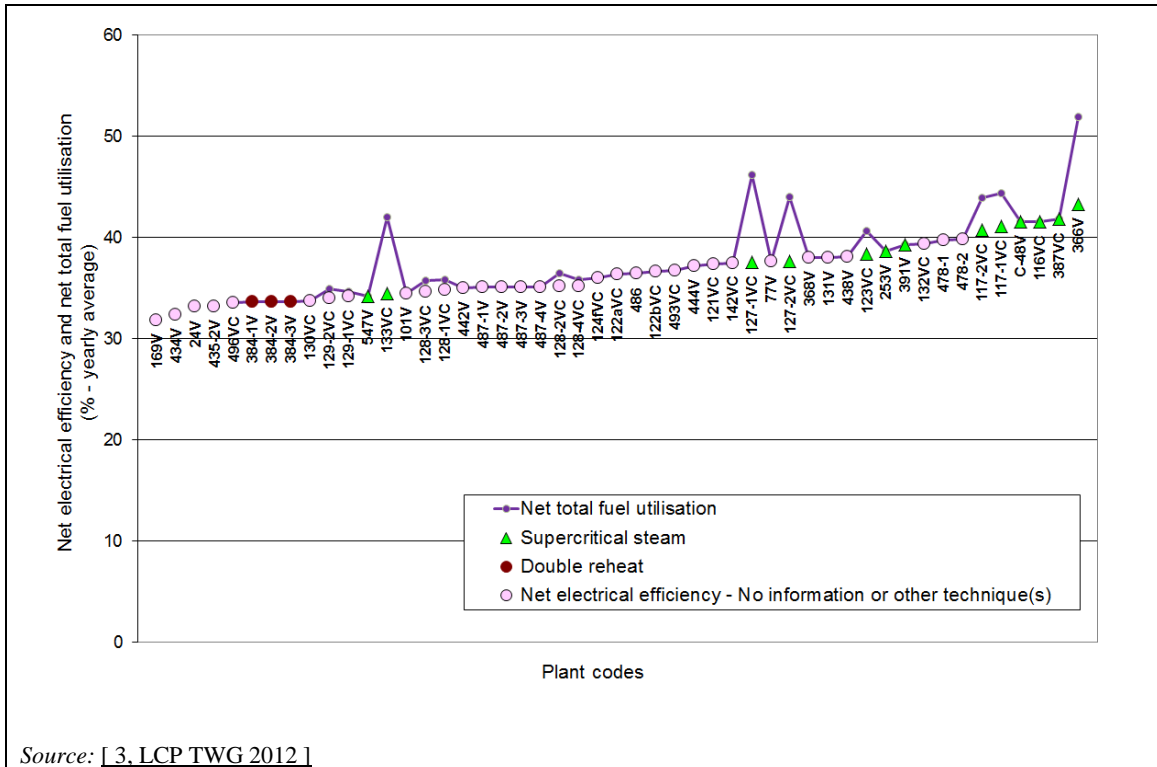

Source: [3, LCP TWG 2012]

Figure 5.24: Operating energy efficiencies of European coal- and/or lignite-fired plants of > 1 000 MW_{th}

Figure 5.25 shows the operating electrical efficiencies and total fuel utilisation of some European coal- and/or lignite-fired plants of less than 1 000 MW_{th}, (from 52 MW_{th} to 1 000 MW_{th}) commissioned between 1969 and 2010, operated between 2 000 h/yr and 8 700 h/yr, with an equivalent full load factor above 56 %. Condensing plants having a yearly electrical efficiency below 34.5 % are quite old (generally commissioned before 1986). Some plants are CHP plants. When their main purpose is to produce electricity, they are equipped with condensing or condensing/extraction steam turbines and produce a limited amount of additional heat, even if sometimes 20 % of the additional fuel utilisation can be achieved (Plants 34V, 662V). When their main purpose is to produce steam or hot water for industrial purposes or district heating, they are equipped with a back-pressure or back-pressure/extraction steam turbine and, despite lower electrical efficiencies, achieve high levels of fuel utilisation (Plants 109V, 376NV). Plants that produce only heat (Plants 20-2V, 69V, 93V) are utility boilers of less than 75 MW_{th}, with fuel utilisation above 80 %.

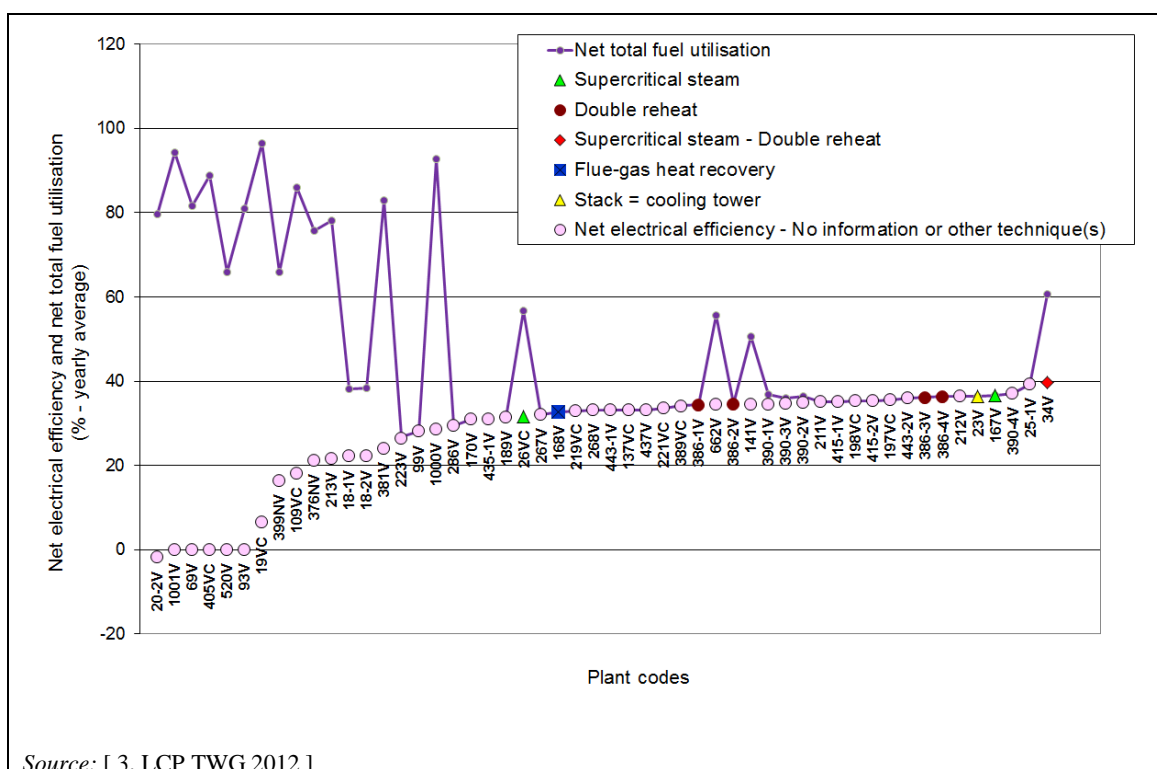

Figure 5.25: Operating energy efficiencies from European coal- and/or lignite-fired plants of < 1 000 MW_{th}

In addition to these operating levels, Table 5.29 and Table 5.30 report design efficiency data achieved in the EU respectively by example power and CHP combustion plants.

Table 5.29: Net design electrical efficiency (%) achieved by example power combustion plants in the EU

Fuel	Up to 2010 included				Post-2010	
	≤ 1 000 MW _{th}		> 1 000 MW _{th}		> 1 000 MW _{th} *	
	Number of plants	Range	Number of plants	Range	Number of plants	Range
Coal	12	32.65–40	21	33.8–43.7	3	45.9–46
Lignite	13	31.4–39.1	5	33.7–42.3	2	42–43.7

* No data were provided for plants of ≤ 1 000 MW_{th}.
Source: [66, TWG Task Force on Energy Efficiency 2014]

Table 5.30: Net design total fuel utilisation (%) achieved by example CHP combustion plants in the EU

Fuel	Up to 2010 included*			
	≤ 1 000 MW _{th}		> 1 000 MW _{th}	
	Number of plants	Range	Number of plants	Range
Coal	8	80–90.5	0	-
Lignite	0	-	4	45–50

* No data were provided for plants commissioned after 2010.
Source: [66, TWG Task Force on Energy Efficiency 2014]

5.1.3.4 Techniques to prevent and/or control dust and metal emissions

5.1.3.4.1 General techniques for the prevention and control of dust and particle-bound metal emissions

Information on general techniques to prevent and control dust and particle-bound metal emissions from combustion plants is given in Section 3.2.2.

Table 5.31 gives additional information specific to lignite and/or coal firing. Further details on related environmental performance and operational data are given after these tables.

Table 5.31: General techniques to be considered for the prevention and control of dust and metal emissions

Technique	Technical description	Achieved environmental benefits	Environmental performance and operational data	Cross-media effects	Technical considerations relevant to applicability		Economics	Example plants
					New plants	Existing plants		
ESP	See Section 3.2.2.1.1	Reduction of particulate emissions. Removal of metals as a co-benefit	High operational experience The dust reduction rate associated with the use of an ESP is considered to be 99.5 % or higher See also graphs and information below the table	Energy consumption (0.1–0.2 percentage points). Increased waste generation	Generally applicable - see comments below	Generally applicable - see comments below	Costs from EUR 13–60 per kW are reported. The figures do not include investment costs for the collected ash handling and transportation systems, which for high ash content lignite are significantly high	Plants 42, 127, 128, 134, 141, 219, 223, 389, 415, 547
Bag filter (BF)	See Section 3.2.2.1.2	Reduction of particulate emissions, particularly fine dust (PM _{2.5} and PM ₁₀). Removal of metals as a co-benefit	High operational experience The dust reduction rate associated with the use of a BF is considered to be 99.95 % or higher. See also graphs and information below the table	The efficiency of the power plant is reduced by 0.1–0.4 percentage points. Bag life decreases with higher sulphur content in the fuel and when using upstream dry sorbent injection	Generally applicable - see comments below	Generally applicable - see comments below	Operating and maintenance costs are higher than for an ESP	Plants 221, 224, 253, 662
Cyclones	See Section 3.2.2.1.3	Reduction of particulate emissions. Very limited reduction of fine particles	High operational experience	NA	Generally applicable - see comments below	Generally applicable - see comments below	Low investment costs	NA
Desulphurisation techniques	See Section 3.2.2.2. These techniques are mainly used for SO _x , HCl or HF control	SO _x and halide reduction with additional reduction effect on dust emissions	NA	NA	See Table 5.36		NA	NA

NB:

NA: No relevant specific information available.

Additional information on applicability

- The ESP has been the better economic solution. In coal-fired combustion, plant bag filters are mainly used downstream of dry and semi-dry techniques to reduce SO_x emissions.
- Mechanical cyclones are only used as a pre-deduster in combination with other techniques such as an ESP or BF.
- Particle-bound mercury is attached to solids, so it can be readily captured in an ESP or in a BF. Where the removal of Hg is low due to the high alkalinity of the fly ash and low level of HCl in the flue-gases, specific/additional techniques may be necessary (see Section 5.1.3.4.3).
- A wet scrubber used for desulphurisation, which is commonly applied in plants above 300 MW_{th}, also reduces dust.

Environmental performance and operational data for dust emissions from well-performing plants based on data collected at European level for 2010

Reported yearly average concentrations from well-performing plants sized between 50 MW_{th} and 100 MW_{th} including pulverised, fluidised bed and grate combustion, are between ≤ 2 mg/Nm³ and 18 mg/Nm³ (see Figure 5.26), for plants operated between 2 000 h/yr and 8 000 h/yr in different industrial sectors, such as power generation, district heating or the chemical industry, with an equivalent full load factor above 60 %. These plants burn coal and/or lignite and reduce dust emissions by means of an ESP containing at least two fields, sometimes co-benefiting also from sorbent injection in the boiler used for sulphur reduction. They were commissioned between 1974 and 2010 and generally monitor their dust emissions continuously. The most recently built plant for which data were reported, an atmospheric CFB boiler commissioned in 2010 with an ESP, achieves 12.5 mg/Nm³ dust emissions on a yearly basis.

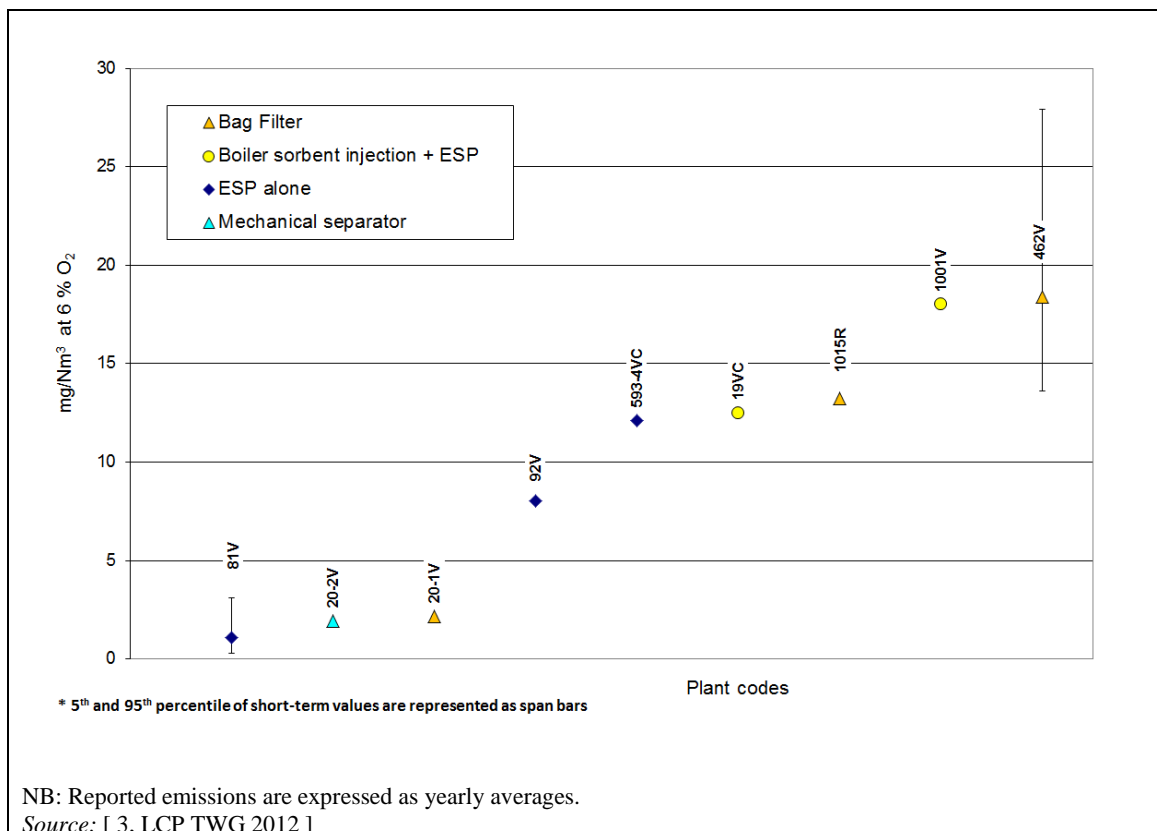

Figure 5.26: Dust emissions from well-performing coal- and/or lignite-fired plants of less than 100 MW_{th}

Reported yearly average concentrations for coal- and/or lignite-fired boilers sized between 100 MW_{th} and 300 MW_{th} are between 0.5 mg/Nm³ and 8 mg/Nm³ (see Figure 5.27) with a big gap then to 17 mg/Nm³ for the next reported emission datum. More data are available from even smaller plants to partially fill in this gap, with emissions between 12 mg/Nm³ and 13.3 mg/Nm³ (Plants 593-4, 19 and 1015 - see Figure 5.26). The reported data in Figure 5.27 correspond to plants operated between 3 000 h/yr and 8 000 h/yr in different sectors, such as power generation, district heating, food and drink or the chemical industry, with an equivalent full load factor above 73 %. These plants reduce dust emissions by means of an ESP or a bag filter, co-benefiting from upstream systems, such as semi-dry absorption or a duct sorbent injection used for sulphur reduction. They were commissioned between 1965 and 2005 and generally monitor their dust emissions continuously. The short-term (half-hourly to daily) averages vary between 0.5 mg/Nm³ and 25 mg/Nm³, over a year (5th – 95th yearly percentiles). The most recently commissioned plant (in 2004) achieves 5 mg/Nm³ dust emissions on a yearly basis.

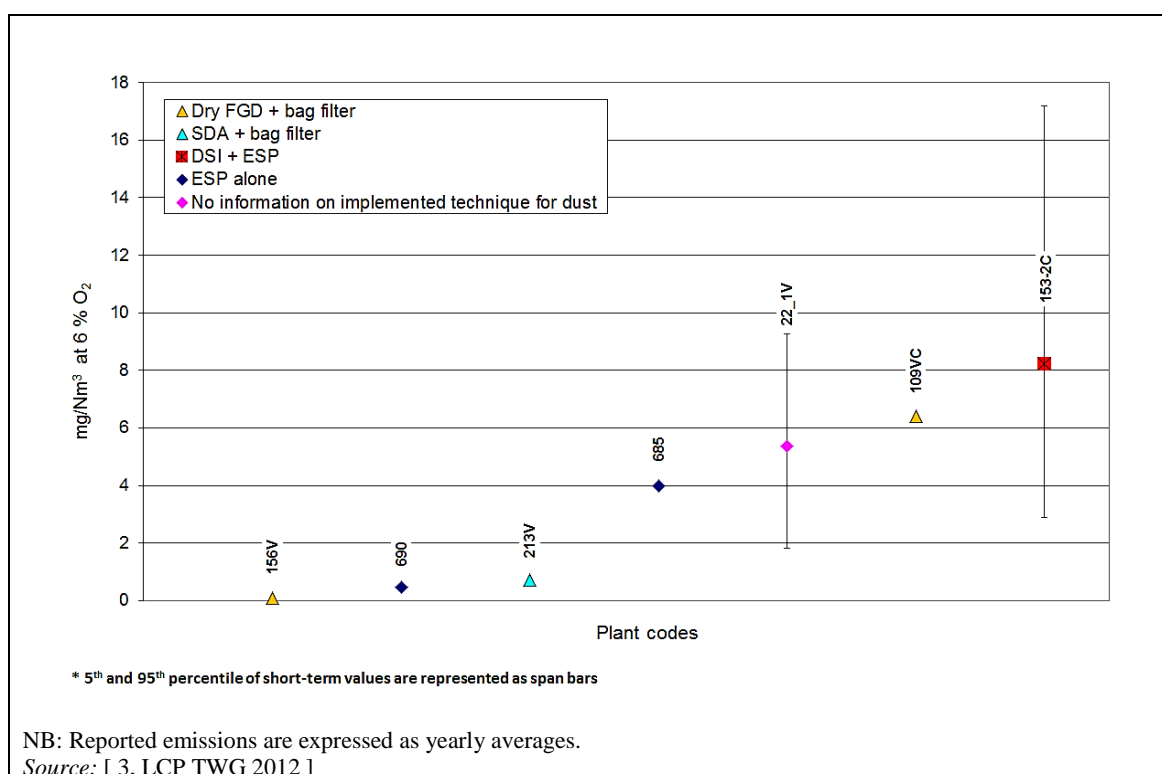

Figure 5.27: Yearly average dust emissions from well-performing coal- and/or lignite-fired plants sized between 100 MW_{th} and 300 MW_{th}

Figure 5.28 reports dust emissions from well-performing coal- and/or lignite-fired combustion plants sized between 300 MW_{th} and 1 000 MW_{th}, operated between 3 000 h/yr and 8 700 h/yr, with an equivalent full load factor in general above 65 %, in different sectors, such as power generation or district heating. The fuel ash content is in general between 10 % and 20 %, with some plants burning fuel with ash contents as low as 2 % or as high as 27 % (raw basis). The reported plants were commissioned between 1963 and 2009 and monitor their dust emissions continuously. The short-term (half-hourly or hourly) averages generally vary between 0.5 mg/Nm³ and 20 mg/Nm³, over a year (5th – 95th yearly percentiles).

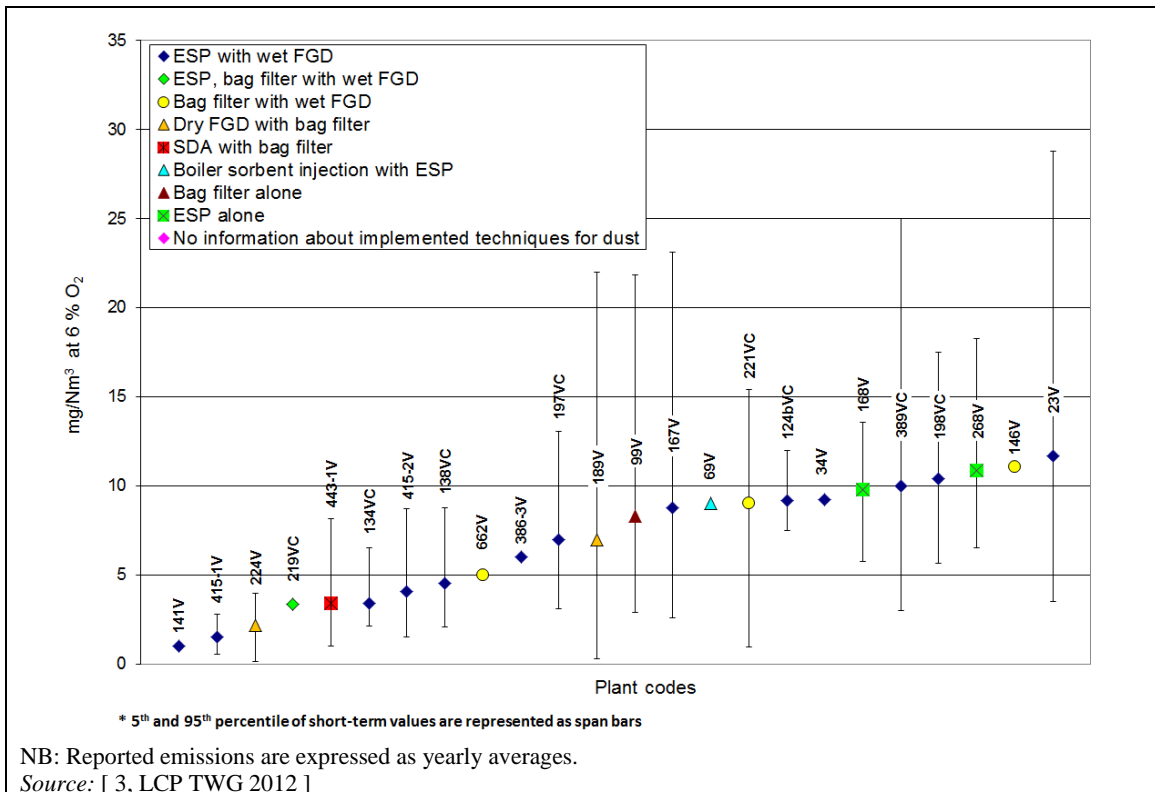

Figure 5.28: Dust emissions from well-performing coal- and/or lignite-fired plants sized between 300 MW_{th} and 1 000 MW_{th}

Figure 5.29 reports dust emissions from well-performing coal- and/or lignite-fired combustion plants of more than 1 000 MW_{th}, operated between 2 400 h/yr and 8 700 h/yr, with an equivalent full load factor in general above 62 %, in different sectors, such as power generation or district heating. The fuel ash content is in general between 5 % and 15 % (raw basis), with some plants burning fuel with an ash content as high as 25 %. The reported plants were commissioned between 1968 and 2009 and monitor their dust emissions continuously. The short-term (half-hourly or hourly) averages generally vary between < 0.5 mg/Nm³ and 14 mg/Nm³, over a year (5th – 95th yearly percentiles). Plants commissioned in the year 2000 (Plants 253V, 116, 117-1/2) achieve yearly averages of less than 5 mg/Nm³.

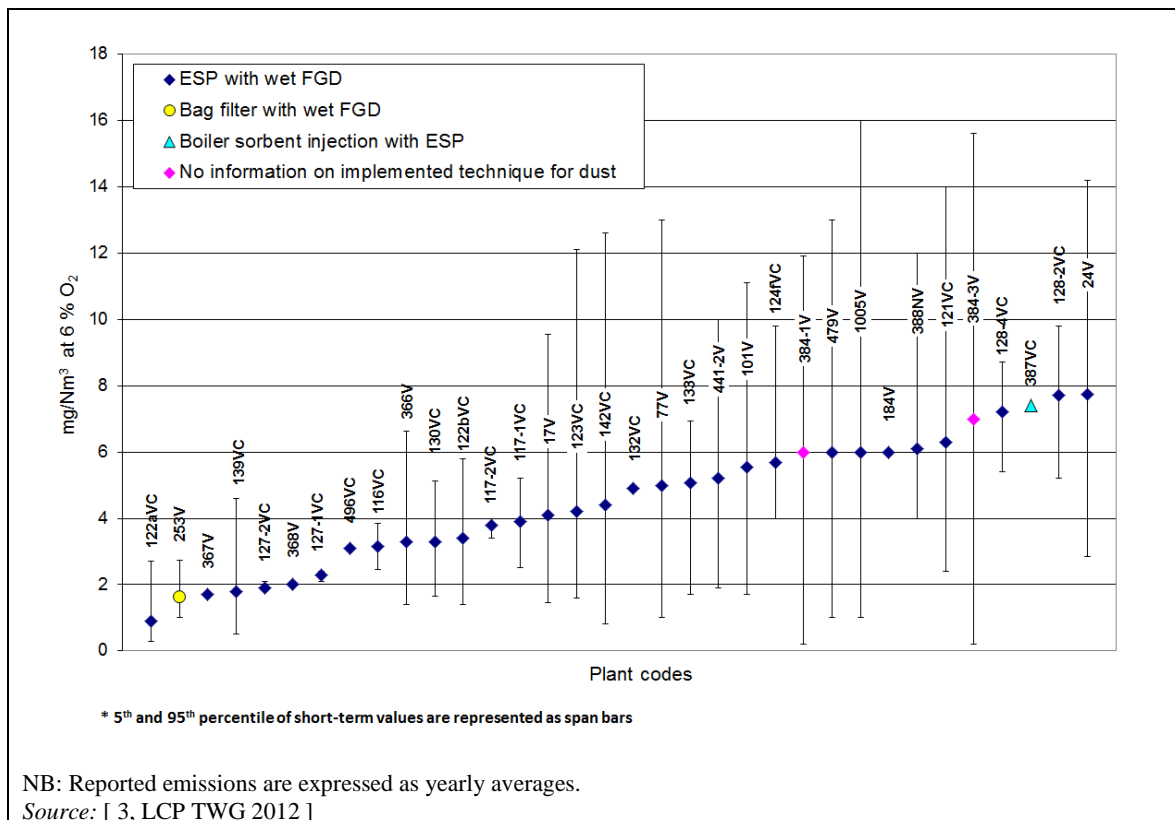

Figure 5.29: Dust emissions from well-performing coal- and/or lignite-fired plants of more than 1 000 MW_{th}

5.1.3.4.2 General techniques for the prevention and control of mercury emissions

Information on general techniques to prevent and control mercury emissions from combustion plants is given in Section 3.2.2.5.

Table 5.32 gives additional information specific to lignite and/or coal firing. Further details on related environmental performance and operational data are given after the table.

Table 5.32: Co-benefit removal of mercury by techniques applied for other pollutants

Technique	Technical description	Achieved environmental benefits	Environmental performance and operational data	Cross-media effects	Technical considerations relevant to applicability		Economics
					New plants	Existing plants	
ESP	Co-benefit of dust emissions reduction by capture of particle-bound mercury - see Section 3.2.2.5.1	Reduction of mercury emissions	High operational experience See also graphs and information below the table	Energy consumption (0.1–0.2 percentage points).	Generally applicable	Generally applicable	NA
Bag filter (BF)	Co-benefit of dust emissions reduction by capture of particle-bound mercury - see Section 3.2.2.5.1	Reduction of mercury emissions	High operational experience See also graphs and information below the table	The efficiency of the power plant is reduced by 0.1–0.4 percentage points	Generally applicable	Generally applicable	Operating and maintenance costs are higher than for an ESP
SCR	Co-benefit of NO _x emissions reduction by enhancing the mercury oxidation before capture in a subsequent FGD unit - see Section 3.2.2.5.3	Improvement of mercury emissions reduction	NA	NA	Not applicable to plants of < 300MW _{th} operated < 500 h/yr. Not generally applicable to combustion plants of < 100MW _{th}	Same considerations as for new plants. Furthermore, there may be technical and economic restrictions for retrofitting plants operated between 500 h/yr and 1 500 h/yr and for existing plants of ≥ 300 MW _{th} operated < 500 h/yr	NA
FGD	Co-benefit of SO _x emissions reduction by solubilising and capturing the oxidised mercury - see Section 3.2.2.5.2	Reduction of mercury emissions	NA	NA	Applicable when the technique is mainly used for SO _x , HCl and or/HF abatement. Wet FGD is not applicable to plants operated < 500 h/r. There may be technical and economic restrictions for applying wet FGD to plants of < 300MW _{th}	Same considerations as for new plants. Furthermore, there may be technical and economic restrictions for retrofitting existing plants operated between 500 h/yr and 1 500 h/yr	NA

NB:
NA: No relevant specific information available.

Environmental performance and operational data for mercury emissions from well-performing plants based on data collected at European level for 2010

- Reported mercury emissions from well-performing coal-fired plants of < 300 MW_{th} sized between 15 MW_{th} and 300 MW_{th} (12 plants reported in Figure 5.30) are between 0.2 µg/Nm³ and 9 µg/Nm³, as a yearly average based on one to five periodic measurements per year. The corresponding plants are fitted with an ESP or a bag filter and were commissioned between 1963 and 2008. It should be noted that some of these plants do not necessarily apply BAT, their NO_x and SO_x emissions being quite high (respectively above 300 mg/Nm³ and 400 mg/Nm³), and may have to implement additional techniques or improve the existing ones to further reduce emissions of those pollutants; this will also have a co-benefit on mercury emissions reduction.
- In addition to Figure 5.30, Plant 520 (coal-fired - 134 MW_{th}) reports Hg emissions of < 8.5 µg/Nm³ as an average of periodic samples over three years. [68, EEB 2013] [69, EEB 2013]
- Figure 5.30 also shows mercury emissions from well-performing coal-fired plants of ≥ 300 MW_{th}, up to 3 800 MW_{th} operated between 2 900 h/yr and 8 760 h/yr, with an equivalent full load factor above 60 %, for power generation and district heating mainly. They burn coal with a Hg content generally between 0.006 mg/kg and 0.9 mg/kg, and a chlorine content between less than 1 mg/kg and 4 460 mg/kg. They were commissioned between 1965 and 2008. The most recent plant (Plant 253V – 2008) has yearly average Hg emission concentrations of about 1 µg/Nm³ and is fitted with SCR, wet FGD and a bag filter. Most of these plants are carrying out periodic Hg emission monitoring (with 2 to 41 periodic measurements per year), and nine of them monitor this pollutant continuously.
- In addition to Figure 5.30, Plant 493 (coal-fired - 1372 MW_{th} x 3) reports Hg emissions of 1.75 µg/Nm³ as an estimation calculated on a mass balance basis within the context of a formal application for an environmental permit in 2012. [70, EEB 2013]

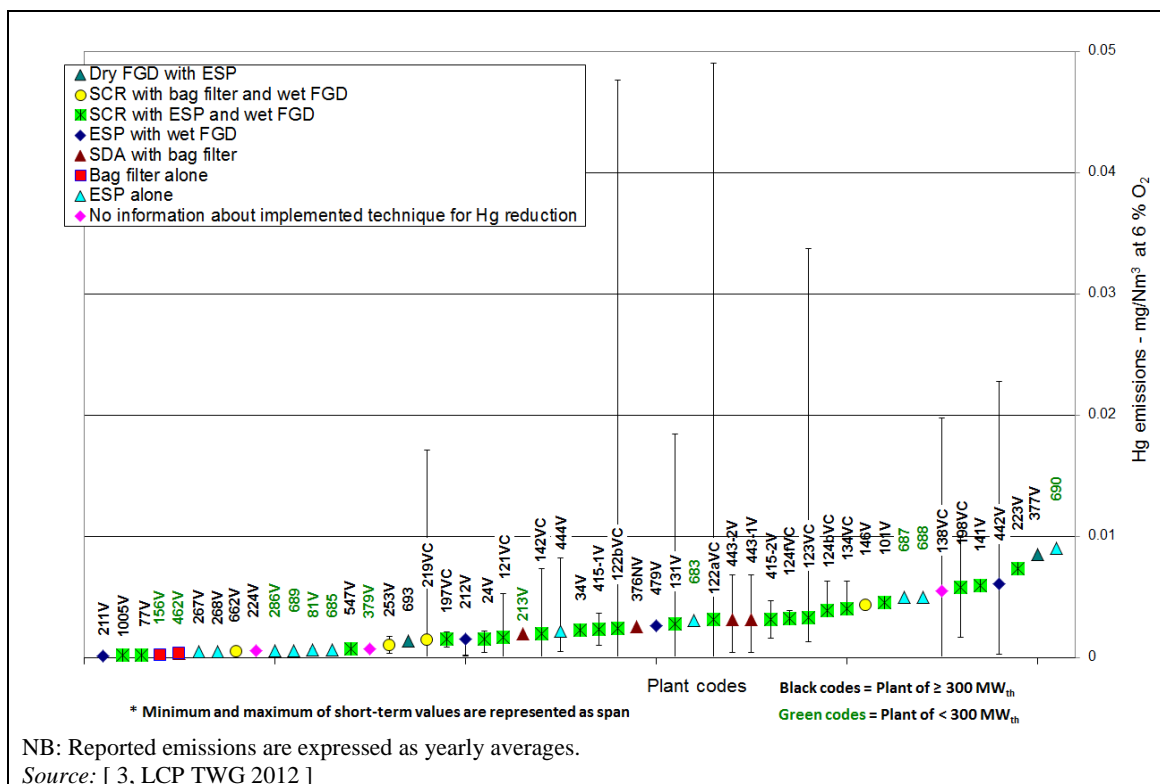

Figure 5.30: Mercury emissions from well-performing coal fired plants

Figure 5.31 shows mercury emissions from well-performing lignite-fired plants sized between 74 MW_{th} and 2465 MW_{th}, operated between 3 600 h/yr and 8 760 h/yr, with an equivalent full load factor above 69 %, for power generation and district heating. Very little information has been reported on the lignite characteristics with as examples levels of chlorine between 100 mg/kg and 210 mg/kg and levels of Hg of about 0.23 mg/kg. These plants were commissioned between 1951 and 2010. The recently built plants (Plant 23V of 890 MW_{th} and Plant 19V of 74 MW_{th}) have yearly average Hg emission concentrations lower than 3.5 µg/Nm³. They do not apply any specific mercury abatement techniques which could further improve their performance. Reported emission values are the result of continuous monitoring in one case, or of periodic monitoring with a measurement frequency between once a year and 12 times a year in the other cases.

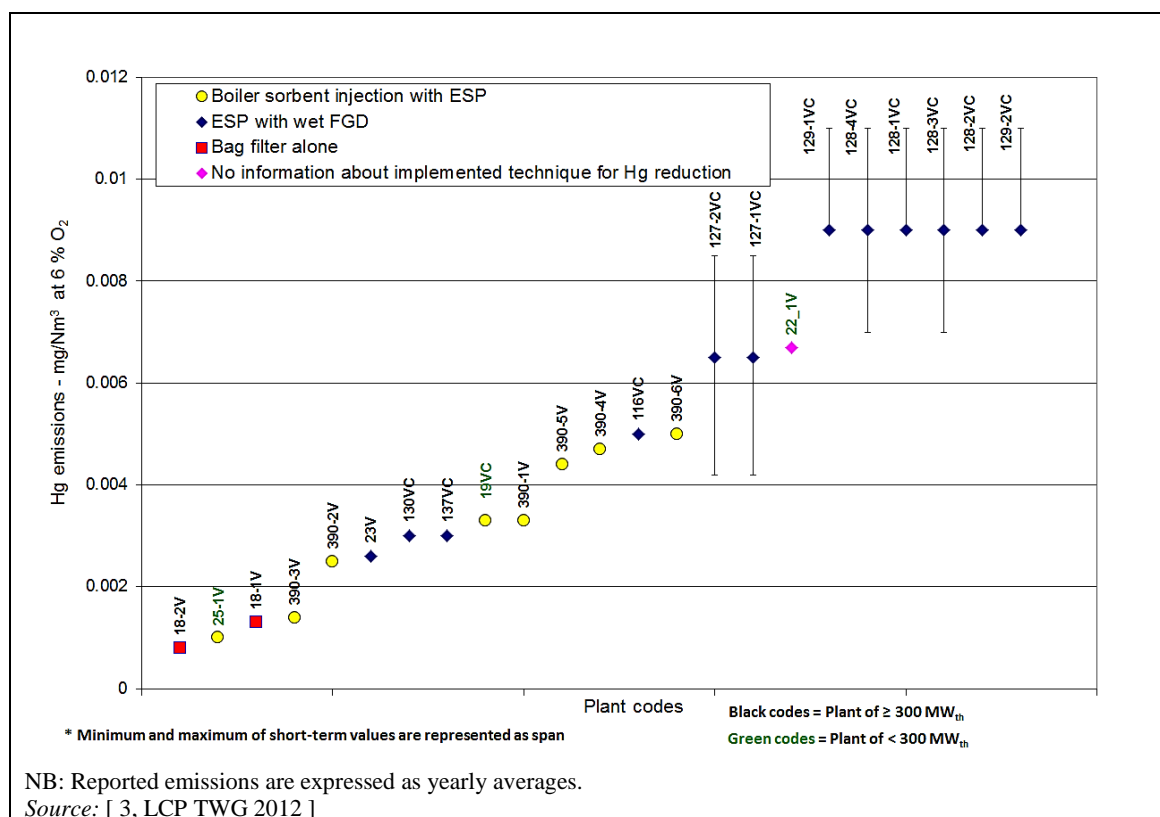

Figure 5.31: Mercury emissions from well-performing lignite-fired plants

Monitoring issues

Monitoring Hg continuously or periodically several times a year permits a better knowledge of the real performance of the plant as the behaviour of Hg throughout the plant is quite complex and may vary substantially at the duct level. Sorbent trap monitoring is a cost-effective alternative to continuous monitoring and has been used as a possible standardised method in the US for mercury monitoring.

For periodic measurements of Hg, EN 13211 was validated in Europe for exhaust gases from waste incineration plants in the range of 1–500 µg/m³. A limit of detection of 2.6 µg/m³ (calculated for a sample gas volume of 50 l) is also given in the standard. For continuous measurements of Hg, the certified automated measurement system with the lowest certification range is reported to have a repeatability standard deviation at zero point of 0.2 % of the certification range, corresponding to a limit of quantification of 0.08 µg/m³. Therefore, it seems that Hg concentrations of < 1 µg/m³ can be measured in some cases, but that the measurement uncertainty will be higher as such levels are close to the limit of detection/quantification.

Information on certification of continuous mercury monitors used in the US with levels of accuracy $\leq 1 \mu\text{g}/\text{Nm}^3$ meeting Performance Certification 12A for mercury continuous emission monitors (CEMS) has been reported. [71, Luminant 2013] [72, EEB 2013]

Examples of monitoring costs for mercury stack emissions are as follows:

- For continuous monitoring, an investment cost of about EUR 80 000–100 000 with an associated operational cost of about EUR 5 000 per year (2010 price levels). The corresponding EN standard is 14884. Calibration difficulties are reported below $5\text{--}10 \mu\text{g}/\text{Nm}^3$.
- For periodic monitoring, a cost of EUR 1 500–3 000 per sample was reported. The EN standard 13211 is validated for the measurement range $1\text{--}500 \mu\text{g}/\text{Nm}^3$.

[60, Lecomte 2014]

5.1.3.4.3 Specific techniques for the prevention and control of mercury emissions

US EPA data suggest that about a quarter of US installations may be achieving $> 90\%$ Hg reductions simply as a co-benefit of using other pollution abatement devices, such as flue-gas desulphurisation, selective catalytic reduction and a bag filter. This technology control configuration is largely implemented in Europe at coal-fired plants for controlling dust and acid gases air emissions. However, these abatement techniques may not always be enough or appropriate for reaching this performance level, due to the coal-lignite characteristics, and may require additional/alternative solutions as described below, for mercury control.

5.1.3.4.3.1 Fuel pretreatment

Description

Pretreating the fuel before combustion can be used with or without additional co-benefit or Hg-specific techniques to achieve good levels of reduction in mercury emissions to air. Pretreatment can be: cleaning, blending with another fuel, and/or using additives.

Technical description

Coal cleaning

There are many types of cleaning processes, all based on the principle that coal is less dense than the pyritic sulphur, rock, clay, or other ash-producing impurities that are mixed or embedded in it. Mechanical devices using pulsating water or air currents can physically stratify and remove impurities. Centrifugal force is sometimes combined with water and air currents to aid in a further separation of coal from impurities. Another method is dense media washing, which uses heavy liquid solutions usually consisting of magnetite (finely ground particles of iron oxide) to separate coal from impurities. Smaller sized coal is sometimes cleaned using froth flotation. This technique differs from the others because it focuses less on gravity and more on chemical separation. [278, US EPA 1997]

These processes remove some of the mercury associated with the incombustible mineral materials. However, they will not typically remove the mercury associated with the organic carbon structure of the coal.

Furthermore, the effectiveness of mercury removal from coal during conventional coal cleaning varies widely depending on the source of the coal and on the nature of the mercury within it. Generally, mercury reduction in lower rank coals/lignite could be expected to be lower than in bituminous coals, because in lower rank coals a greater fraction of mercury is likely to be bound to the organic carbon structure and so will not be removed.

Coal blending/switching

In the context of mercury control, there are two objectives of coal blending:

- to increase halide concentrations, thereby increasing the proportion of oxidised mercury, which is water-soluble and can therefore be more easily captured by a flue-gas desulphurisation scrubber;
- to reduce the amount of mercury to be removed by blending with or switching to low-mercury coals.

Coal additives

The amount of mercury capture generally increases as the amount of halides in coal and unburnt carbon increases. Therefore, mercury capture can be increased in coals with a low halide content by adding halides, particularly bromide. Alternatively, hydrogen chloride or ammonium chloride may be added. Bromine is thought to have an advantage over chlorine as its Deacon-type reactions are more favourable and it is consumed by SO₂ to a lower degree than chlorine, thus requiring the use of a smaller amount of additive.

With the main application of this technique, i.e. bromide addition, coal additives basically form a subset of the Br addition technique examined in more detail in Section 5.1.3.4.3.3. Addition before the boiler is one of several possible options for adding bromide to the fuel, and this will be discussed in more detail in that section.

Achieved environmental benefit

- Reduction of mercury in emissions to air.
- Reduction of fuel ash (from about 40 % to 20–30 %) and sulphur contents.
- Fuel heating value increase.

Environmental performance and operational data

Due to variations in the source of the coal and the nature of the mercury within it, the effectiveness of coal cleaning for mercury removal varies widely. In one analysis of 26 US bituminous coal samples, 5 showed no mercury removal with conventional coal cleaning, whilst the remaining 21 samples had mercury reductions ranging from 3 % to 64 %, with the average of all samples being approximately 21 %. However, another study of 24 samples of bituminous coal showed an average mercury reduction of 37 % on an energy basis, with values ranging from 12 % to 78 %.

By increasing the proportion of oxidised mercury, coal blending has the potential to increase mercury capture by the FGD scrubber by up to 80 %.

Cross-media effects

Transfer of mercury to waste waters in the case of using wet cleaning techniques. The dissolved mercury can be precipitated with sulphides like a usual FGD waste water technique, but dissolved organic carbon (DOC) will not be reduced with the usual techniques of the power plant.

Regarding the cross-media effects of coal additives or coal blending/switching, see also Section 5.1.3.4.3.3 on the use of halogenated additives.

Technical considerations relevant to applicability

Given the variability depending on the source of the coal and on the nature of the mercury contained, pretreatment techniques such as coal cleaning need to be tested to determine how much mercury could be removed from a given coal.

With the use of coal additives, it is very important to achieve an even distribution of the additives across the fuel to achieve effective mercury reduction.

Economics

For coal additives, see Section 5.1.3.4.3.3.

Driving force for implementation

No information provided.

Example plants

For coal additives: Pleasant Prairie power plant (USA).

Reference literature

[2, EEB 2012], [73, KEMA - VGB Powertech 2012], [74, ECOBA 2012], [75, VGB Powertech 2012], [76, EEB 2012], [77, EEB 2012], [78, Bustard et al. 2005]

5.1.3.4.3.2 Carbon sorbent injection

Description

Mercury absorption by carbon sorbents, such as activated carbon, generally injected in the flue-gas.

Technical description

This is the most mature mercury-specific control technology, in which mercury is absorbed by carbon sorbents, with or without chemical treatment. The sorbent injection system can be enhanced by the addition of a supplementary bag filter. Untreated carbon sorbents may be less effective for low rank fuels. However, chemically treated sorbents (e.g. with halides such as chlorine or bromine) can help to convert the more difficult-to-capture mercury contained in such low rank fuels to a more easily captured form, thereby achieving high mercury reduction across all coal types.

Sorbent enhancement additives have been also used at some plants to considerably reduce the rate of sorbent injection and to preserve the quality of its fly ash for reuse. These objectives are being further enhanced by refining sorbents through milling and changing the sorbent injection sites. In addition, some applications have found that injecting sorbents on the hot side of air preheaters can decrease the amount of sorbent needed to achieve the desired levels of mercury control.

Achieved environmental benefit

- Reduction of mercury emissions.
- Positive side effect on the removal of SO_x and NO_x, thereby increasing the cost-effectiveness of the application.
- Increased dust abatement where an ESP or BF is used.

Environmental performance and operational data

Commercial deployments and 50 US Department of Energy (DoE) industry tests of sorbent injection systems achieved on average 90 % reductions in mercury emissions. These systems are being used on 25 boilers at 14 US coal-fired plants. The effectiveness of the sorbent injection is largely affected by the coal type and boiler configuration and by the appropriate and homogeneous distribution of sorbent material over the duct cross section. A US Environmental Protection Agency (EPA) analysis of the best performers showed an average mercury emission reduction of nearly 96 % across all three primary coal ranks i.e. bituminous, sub-bituminous and lignite.

Mercury removal increases with the amount of sorbent injected into the flue-gases. Among the plants studied by the US DOE, the average sorbent injection rate was 6.5 vol-%, with rates ranging from 0.8 vol-% to 17.5 vol-%.

The removal efficiency of the carbon sorbents increases if a bag filter is used instead of an ESP, due to the longer residence time allowing more contact between the sorbent and the mercury-laden flue-gas. As a result, only one third of the sorbent is needed to capture the same amount of mercury compared to an ESP.

However, substantial reductions are not achievable at all plants as:

- Sulphur trioxide – which can form under certain operating conditions or from using high-sulphur bituminous coals – may limit mercury reductions by preventing mercury from binding to carbon sorbents.
- Hot-sided electrostatic precipitators can reduce the effectiveness of sorbent injection systems, because the high operating temperatures reduce the ability of mercury to bind to sorbents and to be collected in the devices. However, high-temperature mercury sorbents have now been developed for use in hot-sided ESPs at temperatures up to 430 °C.
- Lignite has relatively high levels of elemental mercury, the most difficult form to capture, e.g. a share of Hg^0 to total Hg in flue-gas of 80 % for lignite-firing boilers against a similar share of 30 % for coal-firing boilers according to a study performed at six power plants in China. [28, S.Wang et al. 2009]

Other strategies, such as blending coals or using other technologies, may be needed to achieve substantial reductions at some plants with these issues, including those shown below.

Sulphur trioxide

- Using an alkali injection system in conjunction with sorbent injection can effectively lessen the sulphur trioxide interference.
- Mercury control vendors are working to develop alternative flue-gas conditioning agents that could be used instead of sulphur trioxide in the conditioning system to improve the performance of the electrostatic precipitators without jeopardising mercury reductions using sorbent injection.
- Although selective catalytic reduction NO_x abatement systems often improve mercury capture, in some cases they may lead to sulphur trioxide interference when sulphur in the coal is converted to sulphur trioxide gas. Newer selective catalytic reduction systems often have improved catalytic controls that can minimise the conversion of sulphur to sulphur trioxide gas.
- High-sulphur bituminous coal (i.e. with a sulphur content of at least 1.7 % by weight) may also lead to the formation of sulphur trioxide interference in some cases, although the number of plants using these high-sulphur coals is likely to decline with increasingly stringent sulphur controls. However, there are two ways of addressing this problem:
 - using alkali-based sorbents to adsorb sulphur trioxide gas before it can interfere with the performance of the sorbent injection system;
 - blending the fuel to include some low-sulphur coal.

Hot-side ESP

- Using a heat-resistant sorbent. Non-brominated ACI has very little mercury capture above 150 °C. Brominated ACI can provide both stable and high levels of mercury reduction, up to temperatures of about 290 °C, and heat-resistant sorbents operate up to 430 °C.
- Installing a bag filter in addition to the sorbent injection system.

Lignite

- Using a higher sorbent injection rate.

- Blending with sub-bituminous coal.

Finally, according to a 2009 US EPA study at two plants equipped with a cold-side or hot-side ESP, with different coal chlorine contents (150 ppm in one case and 1 400 ppm in the other case), with brominated activated carbon injection upstream of these devices, no increase in air emissions of total and Toxic Equivalent (TEQ) chlorinated and brominated dioxin compounds were noted when compared to the content without activated carbon injection. [79, Hutson et al. 2009]

Cross-media effects

- Higher mercury content in the fly ash.
- Brominated/chlorinated activated carbon may cause corrosion.
- Higher organic matter in the fly ash composition (unburnt carbon in excess of 1–1.5 percentage points).

Effects on coal combustion residues

Both chemically and non-chemically treated carbon sorbents impact on coal combustion residues (CCRs), in particular the fly ash and FGD sludge. This results in CCRs with an increased content of mercury and other co-collected metals (e.g. arsenic and selenium) and the presence of injected sorbent and other chemical modifiers. Tests undertaken by the US EPA show that the mercury is strongly retained in the CCRs, and is unlikely to be leached at levels of environmental concern. In some facilities, arsenic and selenium may be leached at levels of potential concern, but this can occur both with and without enhanced mercury control technologies. However, in many cases, the amount of mercury, arsenic and selenium released from CCRs is estimated to be a small fraction (< 0.1 % – 5 %) of the total content.

Excess bromine that has not reacted with mercury, and which is converted to bromide, can leach to some degree if stored in wet ponds, depending on the contact time and the amount of water to which it is exposed. Apart from that, Br will not leach because it is chemically reacted onto the activated carbon in the gas phase bromination process. There is also limited Br leaching when the fly ash containing the sorbents is used in concrete.

The carbon in sorbents can render fly ash unusable for some purposes, thus increasing the need for storage and disposal. Such disposal may not be allowed in some EU countries. However, advances in sorbent technologies that have reduced sorbent costs at some plants also offer the potential to preserve the market value of fly ash, and therefore its use as a by-product, e.g. at least one manufacturer offers a concrete-friendly sorbent to help preserve fly ash sales. Alternatively, the fly ash could be segregated with a supplementary bag filter or be processed in an additional treatment facility to extract the mercury-containing carbon fraction. There is a process available which separates the carbon-rich particles. This fraction, carbon-rich and containing the mercury, is disposed of as hazardous waste, depending on national legislations. [73, KEMA - VGB Powertech 2012]

When fly ashes are thermally reprocessed, there may be also a need to use an additional technique to further segregate the mercury-containing carbon fraction prior to the thermal treatment, in order to avoid the re-release of the captured Hg in the fly ash as elemental mercury. [73, KEMA - VGB Powertech 2012]

According to a supplier of brominated ACI (activated carbon injection) systems, the mercury content of the concrete would be 0.00001 %. However, some discoloration of the concrete can occur with the use of ACI.

There is an increase in PM loading of < 4 %, due to sorbent injection, and this is even lower when halogenated sorbents are injected. Calculations suggest that the increase in PM_{2.5} would be < 0.2 %. When ESPs are used, this increase is offset by the brominated ACI improving the

operation of the ESP, by the sorbent changing the resistivity of the fly ash, resulting in the change of the electric field of the ESP.

Technical considerations relevant to applicability

Generally applicable for new and existing plants.

Mercury removal is more effective with the use of bag filters. 80–90 % reductions were achieved with all three main types of coal (bituminous, sub-bituminous and lignite) and on boiler types that exist at three quarters of US coal-fired plants.

Plain ACI can be used for applications requiring up to 50–60 % mercury removal, with brominated ACI able to achieve reductions above 90 %.

Economics

In the US DOE R&D programme, the costs of purchasing and installing sorbent injection systems and monitoring equipment averaged USD 3.6 million, ranging from USD 1.2 million to USD 6.2 million. Where bag filters have also been installed, primarily to assist the sorbent injection system in Hg reduction, the average cost is USD 16 million, ranging from USD 12.7 million to USD 24.5 million. The apportioning of these average capital costs is set out in Table 5.33.

Table 5.33: Example of capital costs for implementing a sorbent injection system for mercury reduction

Component costs	Sorbent injection system	Sorbent injection system + bag filter to assist in mercury removal
Number of boilers	14	5
Sorbent injection system	USD 2 723 277	USD 1 334 971
Mercury emissions monitoring system	USD 559 592	USD 119 544
Consulting and engineering	USD 381 535	USD 1 444 179
Bag filter		USD 19 009 986
TOTAL	USD 3 594 023 ⁽¹⁾	USD 15 785 997 ⁽¹⁾
⁽¹⁾ Numbers do not add up to total. The total cost was provided for all of the boilers, but individual cost category data was only provided for some of them.		

Another source from an activated carbon injection systems provider gives fixed cost (2013 price levels) of USD 0.5–1.5 million per installation.

The average annualised operating costs of sorbent injection systems in the US are USD 640 000 – almost entirely sorbent costs. These costs are now being reduced in some applications by the use of sorbent enhancement additives.

Eight boilers in the DOE study reported actual or estimated fly ash-related costs at an average net cost of USD 1.1 million per year.

For those plants that installed a sorbent injection system alone to meet mercury emission requirements, the cost to purchase, install and operate sorbent injection and monitoring systems represented an additional cost of USD 0.12 cents per kilowatt hour.

Driving force for implementation

The driver for implementing mercury control techniques is the prospect or existence of legislation.

Example plants

The US EPA undertook a detailed study of 25 boilers at 14 coal-fired plants in the United States where sorbents have been commercially applied. Of these, 13 have been identified by the US authorities – BI England, New Jersey; Brayton Point, Massachusetts; Bridgeport Harbor, Connecticut; Crawford, Illinois; Fisk, Illinois; Indian River Generating Station, Delaware; Mercer Generating Station, New Jersey; Presque Isle, Michigan; TS Power Plant, Nevada; Vermillion Power Station, Illinois; Walter Scott junior Energy Centre, Iowa; Waukegan, Illinois; Weston, Wisconsin. All met the emissions reductions required by their State, and averaged 90 % reductions. For example:

- A 164 MW_e bituminous-fired boiler, built in the 1960s and operating a cold-side electrostatic precipitator and wet scrubber, exceeded its 90 % reduction requirement, achieving more than 95 % mercury emission reductions using chemically treated carbon sorbent.
- A 400 MW_e sub-bituminous-fired boiler, built in the 1960s and operating a cold-side electrostatic precipitator and a bag filter, achieved a 99 % mercury reduction using untreated carbon sorbent, exceeding its 90 % reduction regulatory requirement.
- A recently constructed 600 MW_e sub-bituminous-fired boiler operating a bag filter, dry scrubber, and selective catalytic reduction system achieved an 85 % mercury emission reduction using chemically treated carbon sorbent, exceeding its 83 % reduction regulatory requirement.

Example plants operated in the US in 2013 are given in Table 5.34.

Table 5.34: Example US plants operating brominated activated carbon injection systems

Plant name	Size, MW _e	Fuel	NO _x	SO _x	Dust	Hg	Hg reduction rate
Detroit Edison St. Clair	169	PRB/low S bituminous (85/15)	LNB	none	Cold ESP	ACI, 48 mg/m ³	94 %
GRE Stanton 10	60	Lignite	None	SDA	BF	ACI, 24 mg/m ³	90 %
PPL Corrette	163	PRB	LNB	None	Cold ESP	ACI, 32 mg/m ³	90 %
Bicent, Harden	119	PRB	LNB	SDA	BF	ACI, 16 mg/m ³	90 %
Sunflower Electric, Holcomb 1	349	PRB	LNB	SDA	BF	ACI, 19 mg/m ³	93 %
Ameren, Meramec 2	138	PRB	LNB	None	Cold ESP	ACI, 53 mg/m ³	93 %
Great river, Stanton 1	188	PRB	None	None	Cold ESP	ACI, 27 mg/m ³	85 %
NRG, Limestone 1	890	Lignite and PRB	NA	WFGD	Cold ESP	ACI, 16 mg/m ³	90 %
Progress, Lee 1	79	Eastern bituminous	LNB	None	Cold ESP	ACI, 128 mg/m ³	85 %

Source: [80, EEB 2013]

Reference literature

[2, EEB 2012], [38, US-GAO 2009], [73, KEMA - VGB Powertech 2012], [74, ECOBA 2012], [80, EEB 2013]

5.1.3.4.3.3 Use of halogenated additives (e.g. bromide)

Description

Addition of halides to the fuel or into the furnace to oxidise the flue-gas mercury into a soluble species, thereby enhancing mercury removal in downstream control devices.

Technical description

The bromide can be injected at any of several different points:

- to the fuel before it gets into the storage bunker;
- to the fuel as it leaves the bunker;
- to the partial fuel streams flowing to different coal mills;
- to the combustion chamber directly via injection spray nozzles;
- to the effluent gas leaving the combustion chamber;
- to the boiler gas (if the temperature is high enough i.e. 500 °C, preferably > 800 °C).

The addition rates range from < 40 ppm to 440 ppm Br per tonne of fuel, dry basis, the most common addition rate being around 50 ppm.

Achieved environmental benefit

Reduced mercury emissions.

Environmental performance and operational data

Mercury oxidation rates of 85 % to > 95 %, reduction rates of 82 % to > 89 %, and emission levels of < 1µg/Nm³ are reported (VGB 2013).

For units without SCR: higher bromide addition rates are required to achieve the same mercury oxidation than for units with SCR.

For units without FGD: bromide addition alone does not reduce Hg emissions significantly, but it improves the effectiveness of ACI for these units. High levels of SO₃ in the flue-gas may limit the efficiency of such a bromide addition/ACI combination and may require an additional SO₃ mitigation technology.

It is important to achieve an even distribution of the bromide onto the fuel. Without this, the performance is less effective.

Cross-media effects

- Flue-gas mercury measurements are very difficult to carry out in the presence of bromine in the flue-gas.
- Potential for bromide-induced corrosion in the ductwork, air heater and in FGD systems, emphasised at higher injection rates. However, the level of Br injected is generally much lower than the level of Cl contained in the fuel, meaning that equipment corrosion should not be significantly impacted by the technique. There is still a residual risk in the long term that needs to be monitored. Experience so far indicates that there is not a clear link between the use of halogenated additives and discernible corrosion problems.

- Increase in bromide and mercury in the fly ash and FGD waste water/gypsum. A decrease in Se in the fly ash is offset by an increase in Se in the FGD liquor. Because of its volatility, the bromide in the gypsum may be emitted into the air during the heating/calcination of the gypsum in the processing industry.
- Potential for re-emission of mercury from the FGD may compromise the achievement of mercury emission levels at stack below $1 \mu\text{g}/\text{Nm}^3$ in some cases. In these cases the control of the FGD redox potential is very important, to prevent the initially adsorbed oxidised mercury (Hg^{2+}) being reduced in the FGD into elemental mercury (Hg^0) and re-emitted via the gas phase through the stack.
- Increase level of Br emissions to air (estimation of $300 \mu\text{g}/\text{Nm}^3$ for an injection rate of 50 mg/kg) and to water (estimation of 340 mg/l of [Br] for an injection rate of 50 mg/kg. Potential increase of AOX emissions to water.

Technical considerations relevant to applicability

Applicable to coals/lignites with a low chlorine content.

Economics

The following costs correspond to a 600 MW_e plant (2013 price levels):

- bromide addition: EUR 130 000 (for 25 mg Br per kg fuel);
- O&M: EUR 10 000 per year;
- annualised installation and license fee costs: EUR 250 000 [(EUR 450 000 installation costs plus EUR 900 000 license fee) x 0.08 annuity factor].

A bromine and bromine derivatives manufacturer in the US provided the following cost data (2013 price levels) for the different additives available (*the exact pricing depends upon the terms of the contracts, including the volume, contract period, package type, delivery location etc.*):

- elemental bromine: mean pricing of USD 4 000/tonne;
- calcium bromide 52 % solution: mean pricing of USD 1 600/tonne;
- sodium bromide 44 % solution: mean pricing of USD 1 400/tonne;
- sodium bromide solid: mean pricing of USD 3 000/tonne.

For plants without SCR (with and without FGD), the use of ACI in conjunction with bromide addition may be more cost-effective than either ACI or bromide addition alone to achieve the same level of performance.

Driving force for implementation

No information provided.

Example plants

In the past few years, dozens of US coal-fired units have begun to operate furnace calcium bromide addition systems to achieve mercury air emissions limits set by local regulations; 50 of them took part in a survey. [39, Dombrowski et al. 2012]

Reference literature

[2, EEB 2012] [39, Dombrowski et al. 2012] [73, KEMA - VGB Powertech 2012] [74, ECOBA 2012] [75, VGB Powertech 2012] [81, Vosteen 2010] [82, Berry et al. 2011]

5.1.3.4.3.4 Other specific techniques for the prevention and control of gaseous mercury

Table 5.36 presents other specific techniques to be considered in the determination of BAT for the prevention and control of mercury emissions from coal- and/or lignite-fired plants, in addition to the ones describes in Sections 5.1.3.4.3.1 to 5.1.3.4.3.3.

Table 5.35: Other specific techniques to consider for the prevention and control of gaseous mercury emissions

Technique	Technical description	Achieved environmental benefits	Environmental performance and operational data	Cross-media effects	Technical considerations relevant to applicability		Economics	Driving force for implementation	Example plants
					New plants	Existing plants			
Optimisation of SCR catalysts for oxidation of Hg ⁰ to Hg ²⁺	NA	Increased share of oxidised Hg in raw flue-gas and hence capture in filter and/or scrubber	R&D on optimised catalysts ongoing	None	Generally applicable	Generally applicable -co-benefit already exists in SCR upstream of wet FGD	Could be high if existing catalysts have to be replaced	NA	NA
Optimisation of SCR catalysts to minimise oxidation of Hg ⁰ to Hg ²⁺	In combination with activated carbon injection	Minimise level of mercury in waste water (e.g. in case of seawater FGD) while maximising capture in ESP/BF	Limited experience	Mercury transfer to fly ash	Generally applicable	Generally applicable	Could be high if existing catalysts have to be replaced	Limit the impact on waste waters	Plant 493
Addition of activated carbon in WFGD	NA	Reduction of Hg emissions	Limited experience	Reduction in gypsum quality (colour, Hg content)	Generally applicable	Generally applicable	Addition of activated carbon in FGD has low investment and operation costs	NA	NA
Addition of organic or inorganic sulphides in FGD	NA	Reduction of Hg emissions	Well known in waste incineration	Gypsum quality, dissolved organic carbons (DOC) in effluent, risk of foaming resulting from bacterial processes	Generally applicable	Generally applicable	Low investment	NA	NA
Addition of strong ligands like bromide in FGD	NA	Reduction of Hg emissions	Limited to lab-scale and a few full-scale tests	More bromide in waste water than from coal only	Generally applicable	Generally applicable	NA	NA	NA
Precipitate Hg separately from other metals in FGD waste water	Concentrates Hg to a low-mass sink and thus indirectly helps to keep Hg away from all other sinks, such as clean gas, gypsum, etc.	Makes a small waste stream product the main sink for Hg	Tested at full scale	Reduces cross-media effects	NA	NA	Only small amount of waste to be disposed of. Low-Hg main share of sludge can be recycled to the furnace	NA	NA

NB:
NA: No relevant specific information available.
Sources: [61, Commission 2006] [84, VDI 2013] [85, Eurelectric 2012]

5.1.3.5 Techniques to prevent and/or control SO_x, HCl and HF emissions

5.1.3.5.1 General techniques for the prevention and control of SO_x, HCl and HF emissions

Information on general techniques to prevent and control SO_x, HCl and HF emissions from combustion plants is given in Sections 3.2.2.2, 3.2.2.4, and 3.2.2.6.

Table 5.36 gives additional information specific to lignite and/or coal firing. Further details on related environmental performance and operational data are provided after this table.

Table 5.36: General techniques to consider for the prevention and control of SO_x, HCl and HF emissions

Technique	Technical description	Achieved environmental benefits	Environmental performance and operational data	Cross-media effects	Technical considerations relevant to applicability		Economics	Example plants
					New plants	Existing plants		
Fuel choice	Lowering the fuel sulphur content can be achieved by multi-fuel firing (replacing part of the coal/lignite with another fuel such as biomass) or by combusting coal/lignite with a low(er) S content (e.g. down to 0.1 %) - see Section 3.1.1.4	Reduction of SO _x emissions at source	High operational experience. Wet-bottom boilers combusting very low-sulphur fuels are able to achieve 200 mg/Nm ³ as a yearly average for SO ₂ to air	Possible increase in dust and NO _x emissions	Generally applicable, generally in combination with other techniques. Applicable within the constraints associated with the availability of different types of fuel, which may be impacted by the energy policy of the Member States. The applicability may be limited due to design constraints in the case of combustion plants combusting highly specific indigenous fuels		Depends on the fuel	Plants 267-268
Natural desulphurisation	Effect of natural desulphurisation, due to the use of some lignites with a low sulphur and a high alkaline ash content - see Section 3.1.1.4	Reduction of SO _x emissions at source	SO ₂ removal as high as 20–50 % for PC and 60–90 % for FBC	May lead, because of the low quality of the fuel, to high dust emissions and higher amounts of residues	Applicable when combusting lignites with a low sulphur and a high alkaline ash content		NA	NA
FBC boiler	Use of the fluidised bed combustion principle. This technique is used in combination with the in-bed sorbent injection technique - See Section 3.2.2.2.9	Reduction of SO _x and NO _x emissions. Limited effect on HCl, when used with an ESP. HF is reduced completely, HCl is reduced partly depending on fuel and CFB technology	High operational experience	Higher emissions of N ₂ O. Market issue for coal ashes mixed with desulphurisation products and with halide salts	Generally applicable, generally in combination with other techniques	Very limited	Plant-specific	Plant 387
Wet FGD	Wet lime/limestone scrubber with gypsum production - see Section 3.2.2.2.1	Reduction of SO _x , HF, HCl, dust, Hg and Se emissions. Gaseous Hg ²⁺ compounds of coal/lignite flue-gas are weakly to strongly soluble, and the more	High operational experience. SO ₂ removal efficiency up to or higher than 99 %. The wet scrubber also has a high reduction rate	Water consumption. Because of the used source of lime, the emissions of As, Cd, Pb and Zn might be slightly higher. Handling and	There may be technical and economic restrictions for applying the technique to combustion	Same considerations as for new plants. Furthermore, there may be technical and economic restrictions for retrofitting existing	Plant-specific. Because of the high costs of the wet scrubbing process, this technique is, for larger plants, the	See graphs below the table

		soluble species can generally be captured in wet FGD scrubbers. The retrofitting of existing plants with FGD provides co-benefits in the control of fine dust and Hg	for HF and HCl (98–99 %)	storage of lime/limestone and end-product (gypsum). Reduction in overall LCP efficiency. Waste water emissions	plants of < 300 MW _{th}	combustion plants operated between 500 h/yr and 1 500 h/yr. The existing wet scrubber can be improved by optimising the flow pattern in the absorber	more economical solution. Not viable to combustion plants operated < 500 h/yr.	
Seawater FGD	See Section 3.2.2.2.2	Reduction of SO _x , HF, HCl, dust, and Hg emissions. Gaseous Hg ²⁺ compounds of coal/lignite flue-gas are weakly to strongly soluble, and the more soluble species can generally be captured in wet FGD scrubbers. The retrofitting of existing plants with FGD provides co-benefits in the control of fine dust and Hg	High operational experience. SO ₂ removal efficiency up to 98 %	Tendency of reduced pH levels in the vicinity of the water discharge and emission of metals and suspended particles to the marine environment	Not applicable to combustion plants operated < 500 h/yr. There may be technical and economic restrictions for applying the technique to combustion plants of < 300 MW _{th} . Only applicable to plants located near the sea	Same considerations as for new plants. Furthermore, there may be technical and economic restrictions for retrofitting existing combustion plants operated between 500 h/yr and 1 500 h/yr.	Plant-specific	Plant 493
Wet scrubbing	See Section 3.2.2.6.2	Acid gas reduction	NA	NA	Generally applicable	NA	Plant 470	
Other wet scrubber types (Magnesium or Ammonia or Lye wet scrubber)	See Sections 3.2.2.2.3, 3.2.2.2.4 and 3.2.2.2.5	Reduction of SO _x . The reduction of other pollutants depends on the specific technique	Very limited	Water consumption + depends on the technique	Generally applicable, but rarely in new plants	Depends on the individual plant	Not available	NA
Spray dry scrubber or absorber (SDA)	See Section 3.2.2.2.6	Reduction of SO ₂ , HF, HCl, SO ₃ , dust, and Hg emissions. Gaseous Hg ²⁺ compounds of coal/lignite flue-gas can generally also be captured in spray dry	High operational experience. SO ₂ removal efficiencies up to 92 %. Halide removal efficiencies > 95 %	Water consumption. Handling and storage of lime and end-product. Slight reduction in overall LCP energy efficiency	Generally applicable up to 1 250–1 500 MW _{th} in one absorber	Generally applicable up to 1 250–1 500 MW _{th} in one absorber	Plant-specific – indicative costs: capex EUR 0.028 million/ MW input excluding civil works – opex EUR 0.37/ MW input. No	Plant 443

		absorber, in particular in combination with a BF. The retrofitting of existing plants with FGD provides co-benefits in the control of fine dust and Hg					significant difference between new and retrofitted plants	
Sorbent injection (in-bed, in-furnace or in-duct dry)	See Sections 3.2.2.2.8, 3.2.2.2.9 and 3.2.2.2.10.	Reduction of SO _x , HF, HCl, dust	High operational experience. SO ₂ removal efficiencies up to 65 % in BFB boilers, up to 80 % in duct injection or other furnace injection systems and up to 95 % in CFB boilers	Residues that need to be landfilled if not utilised in coal mines. Higher particulate matter downstream of the boiler; in existing plants, ESPs may be under designed to handle the increased dust load	Generally applicable		NA	Plants 109 (DSI) 19 - 387 (Boiler sorbent injection)
CFB scrubber	See Section 3.2.2.2.7	Reduction of SO _x and halide emissions. Improvement of dust removal efficiency	SO _x removal efficiency: 90–99 % Halide reduction efficiency: > 95 %	By-product marketability may be an issue	Generally applicable		NA	Plant 189
Use of organic acids in wet FGD system	See Section 3.2.2.2.1	Increased wet FGD efficiency	NA	Increased BOD in waste water that may require additional treatment equipment	Not practised	Generally applicable	NA	NA
Others (sodium sulphite bisulphite process, magnesium oxide process, others)	See Section 3.2.2.2.12	Reduction of SO _x and NO _x . The reduction of other pollutants depends on the specific technique	Very limited	NA	Generally applicable, but rarely in new plants	Depends on the individual plant	Not available	NA
Combined techniques	See Section 3.2.2.4	Combined reduction of NO _x and SO _x	Limited experience	NA	NA	NA	NA	Isogo (Japan)
NB: NA: No relevant specific information available.								

Environmental performance and operational data from well-performing plants

For SO₂ emissions

Figure 5.32 presents the SO₂ emissions from well-performing plants in the > 300 MW_{th} size category, combusting coal and/or non-indigenous lignite, commissioned between 1965 and 2009, sized between 380 MW_{th} and 4120 MW_{th}. Except in the case of one plant, which is fitted with a seawater FGD, all the others are fitted with wet FGD. They are operated between 4 000 h/yr and more than 8 000 h/yr, with an equivalent full load factor above 62 %. The fuel sulphur content is, in general, between 0.5 wt-% and 1.1 wt-%, dry, reaching 2.9 % for Plant 23V. The ash content is generally between 10 % and 20 %, and in some cases up to 25 %. The reported averaged SO₂ reduction efficiency of the wet FGD for these plants is between 86 % and 99 %. The more recently commissioned plants (23V, 253V and 391V), commissioned between 2007 and 2009, have yearly average SO_x emission concentrations between 46 mg/Nm³ and 106 mg/Nm³. SO_x emissions are continuously monitored for all of them. The reported short-term (mainly hourly) averages are generally below 200 mg/Nm³ over a year (5th – 95th yearly percentiles), or slightly higher (e.g. Plant 388 or Plant 139 with 95th percentiles of hourly averages respectively of 205 mg/Nm³ and 211 mg/Nm³).

In addition to Figure 5.32 and from the collected data for the BREF review, it can also be noted that:

- the best performing fluidised bed boiler of > 300 MW_{th} (Plant 387, burning coal) achieves a yearly average concentration of 170 mg/Nm³, with the boiler sorbent injection technique, and was quite recently commissioned (2009);
- the lowest SO₂ emission levels achieved by plants using only very low-sulphur fuels as the primary technique (0.13 % wt, dry) is about 200 mg/Nm³ on a yearly basis (Plants 267-268).

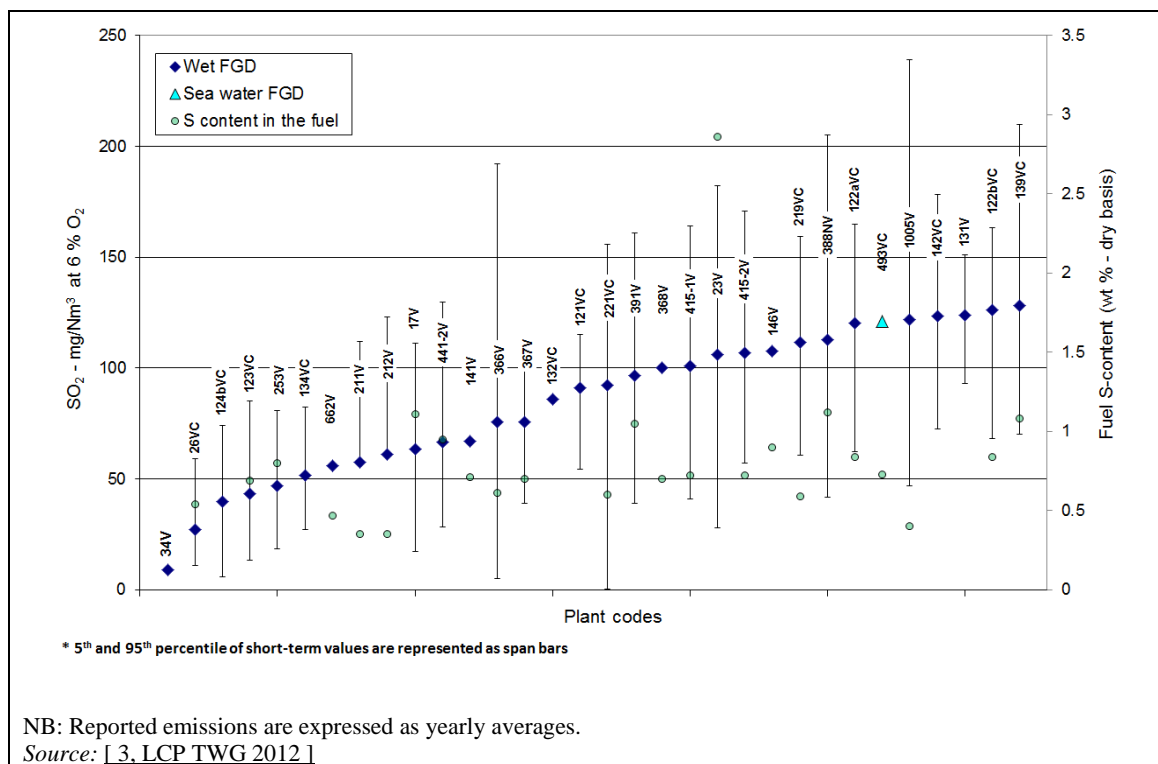

Figure 5.32: SO₂ emissions from well-performing coal- and/or lignite-fired combustion plants of more than 300 MW_{th} burning coal and/or non-indigenous lignite

Figure 5.33 presents the SO₂ emission from example plants in the size category > 300 MW_{th} combusting indigenous lignite and fitted with a wet FGD. They are either combusting fuels with roughly the same S and ash characteristics as non-indigenous fuels (slightly wider range for ash content from 5 % to 25 %) or combusting fuels with a higher sulphur content (> 3 %, wt-%, dry). These plants have less or no flexibility in using the fuel choice as a technique to reduce the SO_x emissions. Since the LHV of lignite is lower than for coal, this could lead to a higher SO₂ content in the raw flue-gas. If some example plants (e.g. Plants 137, 130, 116, 170) are able to achieve similar SO₂ emission levels to well-performing plants combusting coal and/or non-indigenous lignite presented in Figure 5.32 with similar S and ash contents in the fuel, there may be some limitations in reaching those levels with for example very high levels of sulphur in the fuel (up to 5.4 % wt-%, dry in Europe), despite applying very efficient secondary abatement techniques for SO_x. The available information (see for instance [332, Staehle 2008], [333, Nakayama et al. 2005]) shows that SO₂ reduction efficiency levels of between 97 % (upgrades of existing systems) and more than 98.5 % (new systems) or even 99 % can be achieved.

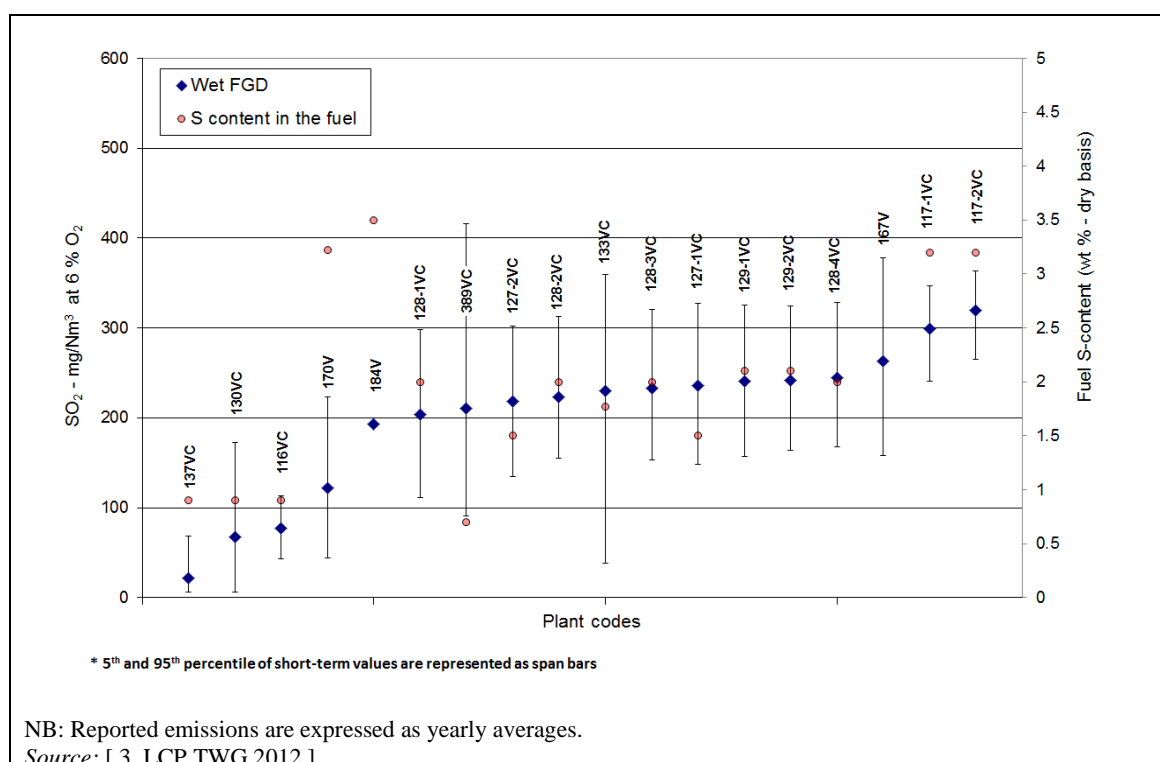

Figure 5.33: SO₂ emissions from example plants of more than 300 MW_{th} burning indigenous lignite

Smaller plants are in general not fitted with wet FGD systems.

The reported data from continuous monitoring for plants sized between 100 MW_{th} and 300 MW_{th} show that some plants (i.e. Plants 109, 153-2) achieve yearly average SO₂ emission levels below 200 mg/Nm³, mainly by using dry sorbent injection and with a sulphur fuel content of about 0.4 %.

The reported data for plants below 100 MW_{th} show that some plants (i.e. Plants 19, 81, 1015, 462) achieve yearly average SO₂ levels below 360 mg/Nm³, mainly by using boiler sorbent injection (BSI) or an SDA. A recently commissioned 75 MW_{th} CFB boiler (Plant 19) achieves yearly average emissions below 200 mg/Nm³ with a BSI.

For HCl and HF emissions

Figure 5.34 and Figure 5.35 show respectively the HCl and HF emissions from well-performing coal- and/or lignite-fired plants, including CFB boilers, of $\geq 100 \text{ MW}_{\text{th}}$. The reported plants are sized between $145 \text{ MW}_{\text{th}}$ and $3\,700 \text{ MW}_{\text{th}}$, operated between 2 900 h/yr and 8 700 h/yr, with an equivalent full load factor in general above 60 %. These plants were commissioned between 1951 and 2009, and burn coal and/or lignite with Cl and F contents respectively between 0.05 mg/kg and 600 mg/kg, and between 0.01 mg/kg and 400 mg/kg. However, only very few plants reported data on these fuel characteristics. These pollutants are monitored in different ways, from periodically, with 1 to 12 measurements per year, to continuously. A quarter of these plants co-incinerate waste up to 3.3 % (LHV basis).

In addition, example CFB boilers operated by Luminant (Sandow 5) and Dominion energy (Virginia City Hybrid Center) in the US and fitted with a CFB dry scrubber report HCl reduction efficiencies of between 95 % and > 99 %, meaning that well-performing CFB or other types of boiler combusting coal or lignite even with a very high chlorine content (e.g. > 1 000 mg/kg), as may be the case in Europe, can achieve HCl emission levels below 20 mg/Nm^3 using this technique for example. Further, HF reduction efficiencies of more than 90 % are also reported. [190, EPPSA 2015] [191, EPPSA 2015]

For plants of $\geq 100 \text{ MW}_{\text{th}}$ operated less than 1 500 h/yr, the levels of HCl and HF emissions may be higher as they may implement only the low-sulphur fuel technique, possibly in combination with dry sorbent injection. The achievable levels of emissions in this case correspond thus to the ones of well-performing plants of $< 100 \text{ MW}_{\text{th}}$, which use similar techniques.

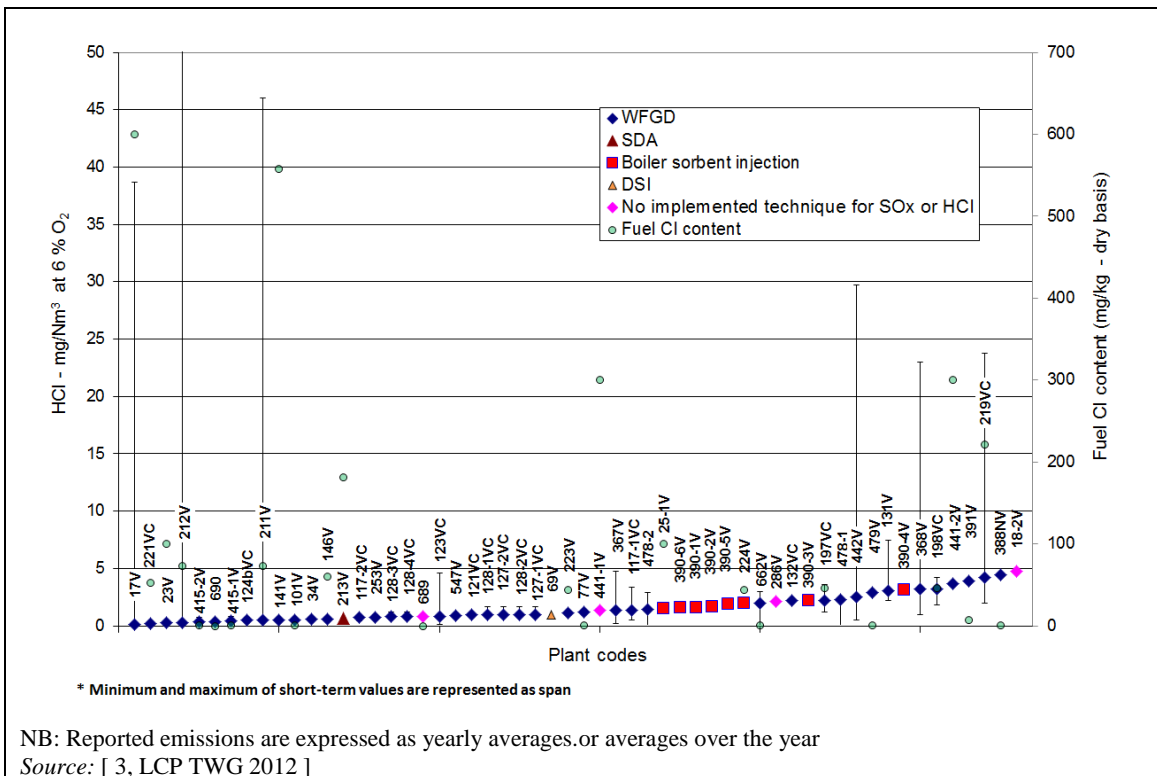

NB: Reported emissions are expressed as yearly averages or averages over the year
 Source: [3, LCP TWG 2012]

Figure 5.34: HCl emissions from well-performing coal- and/or lignite-fired plants of $> 100 \text{ MW}_{\text{th}}$

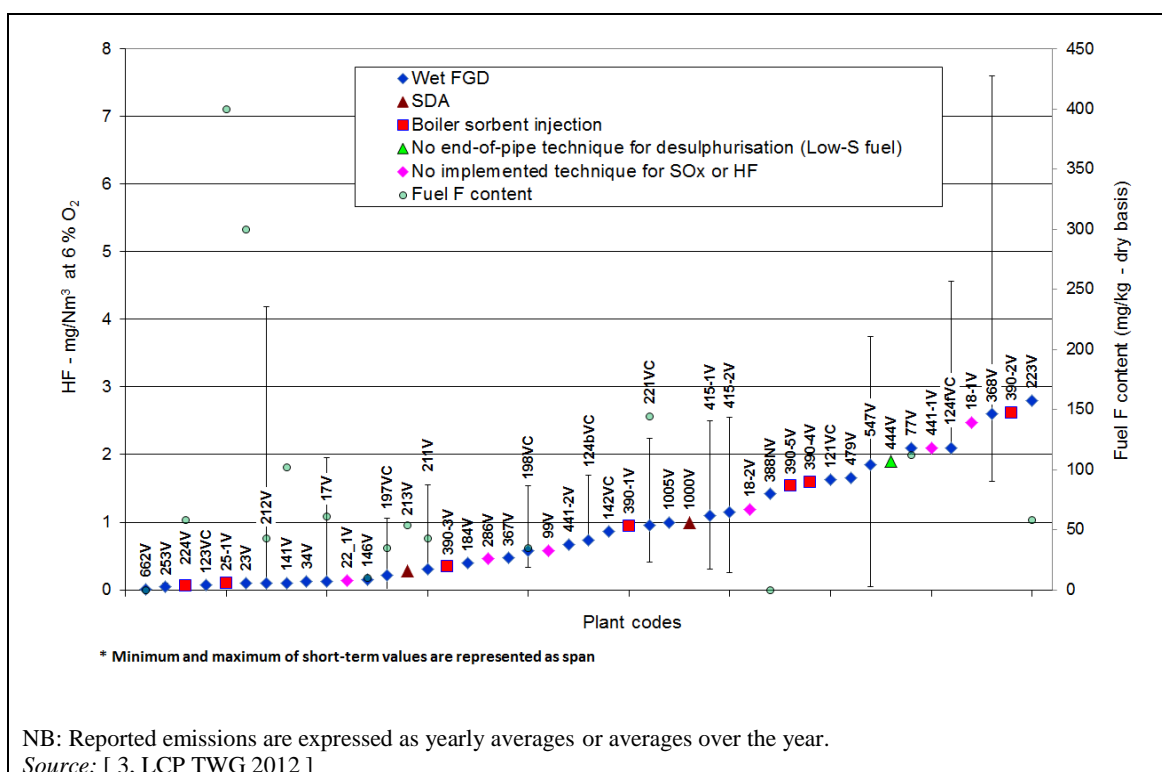

Figure 5.35: HF emissions from well-performing coal- and/or lignite-fired plants of $> 100 \text{ MW}_{\text{th}}$

HCl reduction efficiencies for plants of $< 100 \text{ MW}_{\text{th}}$ will generally be about half that of the one of plants of $\geq 300 \text{ MW}_{\text{th}}$, based on the comparison of SO_2 emission levels when applying dry techniques. The HCl emission levels from well-performing plants will be about the double of those from bigger plants, i.e. within $2\text{--}10 \text{ mg/Nm}^3$. For example, Plants 19 and 462 respectively fitted with boiler sorbent injection and SDA, or Plants 20-1/2 and 407 using a fuel with moderate Cl content ($< 70 \text{ mg/kg}$, dry), achieve HCl yearly average emission levels between 0.3 mg/Nm^3 and 7.2 mg/Nm^3 . For the same reasons, HF emission levels from well-performing plants will be within $< 1\text{--}6 \text{ mg/Nm}^3$. For example, Plants 81 and 1001 fitted with boiler sorbent injection, or Plants 20-1/2 using a fuel with moderate F content, achieve HF yearly average emission levels of $< 1 \text{ mg/Nm}^3$.

5.1.3.5.2 Replacement of the gas-gas heater located downstream of the wet FGD

Description

Replacement of the gas-gas heater downstream of the wet FGD by a multi-pipe heat extractor, or removal and discharge of the flue-gas via a cooling tower or a wet stack.

Technical description

Possible internal flue-gas leakage problems in the rotating gas-gas heat exchanger can result in high levels of SO_x , HF or HCl in the stack, because of raw flue-gas flowing directly to the stack without reducing the SO_x , HF and HCl contents. In order to avoid such leaks, the gas-gas heat exchanger can be replaced by a new one, in the form of a combination of a heat extractor (multi-pipe heat extractor) and a reheater, or using heat pipes. A number of plants have installed new types of heat exchangers for flue-gas reheating, to avoid possible contamination of the scrubbed flue-gas by raw flue-gas.

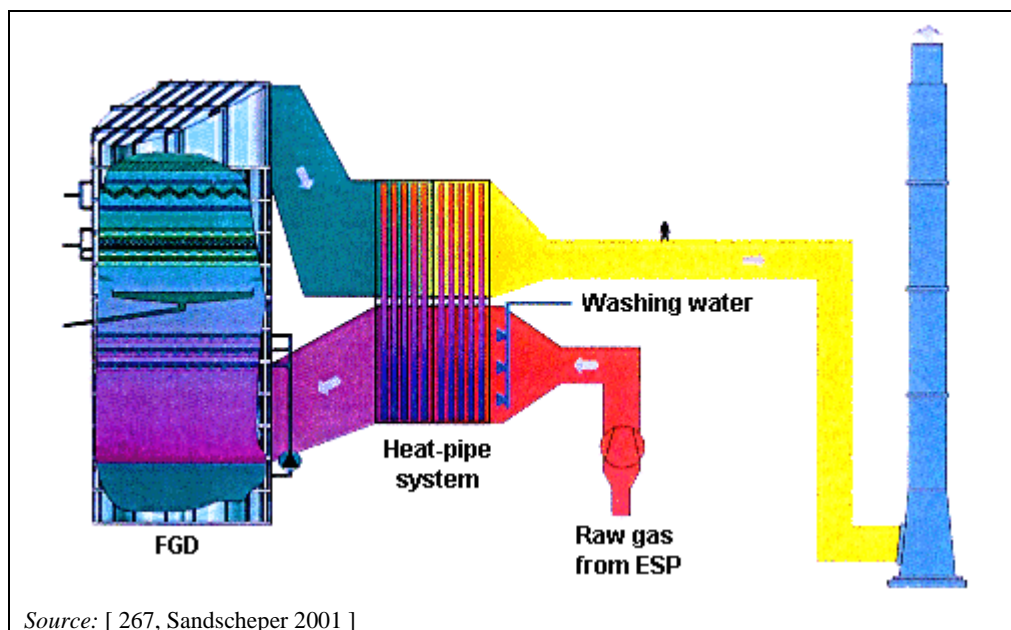

Figure 5.36: Heat displacement around the FGD unit

In these gas-gas heat exchangers, multi-pipe heat extractors are used to transfer the heat from the hot raw flue-gas to the clean scrubbed flue-gas. These systems eliminate leakage because it is not necessary to cross the duct outlet with the duct inlet, as is the case in the normal regenerative gas heat exchanger.

However, the best option is flue-gas discharge via the cooling tower, if possible. In this case, no flue-gas reheating is necessary and therefore no gas-gas heat exchanger is needed. Another option is the use of a high-grade drop catcher and passing the flue-gas via an acid-resistant stack pipe (wet stack), where no flue-gas reheating is necessary and therefore no gas-gas heat exchanger is needed.

Achieved environmental benefit

No information provided.

Environmental performance and operational data

No information provided.

Technical considerations relevant to applicability

No information provided.

Cross-media effects

No information provided.

Economics

Because of operational and economic reasons, replacement is only considered when the heat exchanger needs to be changed or replaced at the end of its useful lifetime.

Driving force for implementation

No information provided.

Example plants

No information provided.

Reference literature

No information provided.

5.1.3.6 Techniques to prevent and/or control NO_x, CO and N₂O emissions**5.1.3.6.1 General techniques for the prevention and control of NO_x, CO and N₂O emissions**

Information on general techniques to prevent and control NO_x, CO and N₂O emissions from combustion plants is given in Section 3.2.2.3.

Table 5.37 and Table 5.38 give additional information specific to lignite and/or coal firing. Further details on related environmental performance and operational data are provided after these tables.

Table 5.37: General primary techniques to consider for the prevention and control of NO_x and N₂O emissions

Technique	Technical description	Achieved environmental benefits	Environmental performance and operational data	Cross-media effects	Technical considerations relevant to applicability		Economics	Example plants
					New plants	Existing plants		
CFB boiler	See Section 2.2.3.2. CFB boilers allow a good combustion performance while limiting NO _x emissions to air, sometimes without the need for an additional technique(s) in the case of plants of < 100 MW _{th}	Reduction of NO _x emissions	High operational experience. NO _x emission levels of 190 mg/Nm ³ have been reported at a recent plant < 100 MW _{th} without additional techniques. N ₂ O emission levels of 20–150 mg/Nm ³ depending on the fuel used (coal or lignite) [61, Commission 2006] [3, LCP TWG 2012]	Tendency to increase N ₂ O emissions	Generally applicable	NA	NA	Plants 377, 385, 387
Low excess air	See Section 3.2.2.3.1	Reduction of NO _x , N ₂ O and SO ₃ emissions	High operational experience	Tendency to higher unburnt carbon-in-ash. Low excess air tends to give higher CO and HC levels. Risk of tube and wall corrosion	Generally applicable	Generally applicable	Depends on the fuel	Plant 444
Air staging (OFA, BBF and BOOS)	See Section 3.2.2.3.2. Generally applied in combination with other primary technique (s) and/or with SNCR and/or with SCR (plants of > 300 MW _{th})	Reduction of NO _x , N ₂ O and CO emissions	High operational experience	Tendency to lead to higher unburnt carbon-in-ash	Generally applicable	Generally applicable. The boiler design should allow sufficient flue-gas residence time	Plant-specific	About 100 European plants of [3, LCP TWG 2012] are fitted with air staging
Boosted Overfire Air (BOFA) or Rotating Opposed Fired Air	See Section 3.2.2.3.2. Commonly applied with SNCR	Reduction of NO _x and CO emissions. Increased energy efficiency	High operational experience in PC boilers combusting coal or biomass. There are also applications in grate-fired boilers or BFB boilers, and more recently in CFB boilers	NA	Generally applicable	Generally applicable	Plant-specific	Plants 379, 486
Flue-gas recirculation (FGR)	See Section 3.2.2.3.3. Generally applied in combination with other primary technique (s) and/or with SCR (plants of > 300 MW _{th})	Reduction of NO _x emissions	High operational experience	Tendency to lead to higher unburnt carbon-in-ash. Slight decrease in energy efficiency	Generally applicable	Generally applicable	Plant-specific	About 25 European plants of [3, LCP TWG 2012] are fitted with FGR

Low-NO _x burners (LNB) (often include flue-gas recirculation and air staging)	See Section 3.2.2.3.5. Generally applied in combination with other primary technique (s) and/or with SCR (plants of > 300 MW _{th})	Reduction of NO _x emissions	High operational experience	Tendency to lead to higher unburnt carbon-in-ash and to increase CO generation at low loads	Generally applicable	Generally applicable	NA	About 90 European plants of [3, LCP TWG 2012] are fitted with a LNB
Reburning (Fuel staging)	See Section 3.2.2.3.6. Generally applied in combination with other primary technique (s) and/or with SCR (plants of > 300 MW _{th})	Reduction of NO _x and CO emissions	High operational experience	Tendency to lead to higher unburnt carbon-in-ash	Generally applicable	Applicability may be limited by space restrictions	Plant-specific	More than 25 European plants of [3, LCP TWG 2012] are fitted with fuel staging
Combustion optimisation	See Section 3.2.2.7.1	Reduction of NO _x , N ₂ O and CO emissions	High operational experience. N ₂ O emission levels of 20–150 mg/Nm ³ for CFB boilers, depending on the fuel used (hard coal or lignite) [61, Commission 2006] [3, LCP TWG 2012]	NA	Generally applicable	Generally applicable	NA	Plants 377, 385, 387
Use of catalytic material such as MgO or CaO in the boiler	NA	Reduction of N ₂ O emissions	Experimental stage	NA	Generally applicable	Generally applicable	NA	NA
Increased flue-gas temperature	NA	Reduction of N ₂ O emissions	Experimental stage	NA	Generally applicable	Generally applicable	NA	NA
Use of catalytic material such as MgO or CaO in the boiler	NA	Reduction of N ₂ O emissions	Experimental stage	NA	Generally applicable	Generally applicable	NA	NA
Increased flue-gas temperature	NA	Reduction of N ₂ O emissions	Experimental stage	NA	Generally applicable	Generally applicable	NA	NA

NB:

NA: No relevant specific information available.

Table 5.38: General secondary techniques to consider for the prevention and control of NO_x and N₂O emissions

Technique	Technical description	Achieved environmental benefits	Environmental performance and operational data	Cross-media effects	Technical considerations relevant to applicability		Economics	Example plants
					New plants	Existing plants		
Selective non-catalytic reduction (SNCR)	See Section 3.2.2.3.12. Can be applied in combination with a 'slip' catalyst	Reduction of NO _x emissions although the reduction rate is much less than with SCR	High operational experience. NO _x emission levels of 172 mg/Nm ³ have been reported at a plant sized between 100 MW _{th} and 300 MW _{th} . See below this table for further information on performance levels	Ammonia slip	Applicable within constraints associated with the required temperature window. Sensibility to load variation that can be reduced by implementing several levels of reagent injection. May be constrained in case of high cross-sectional area of the boiler		Plant-specific	Plants 69, 81, 109, 153-2, 224, 376, 387, 462
Selective catalytic reduction (SCR)	See Section 3.2.2.3.11	Reduction of NO _x emissions	High operational experience. See below this table for further information on performance levels. Very few lignite-fired plants of < 1 000 MW _{th} have been fitted with SCR so far, in the US.	Ammonia slip. SO ₃ emissions for fuels containing high sulphur level	[27, ICAC 2009] [40, EEB 2012] Not applicable to plants of < 300 MW _{th} operated < 500 h/yr. Not generally applicable to combustion plants of < 100 MW _{th} . There may be technical and economic restrictions for retrofitting existing combustion plants operated between 500 h/yr and 1 500 h/yr and for existing combustion plants of ≥ 300 MW _{th} operated < 500 h/yr. Sensitivity to the fuel characteristics (e.g. high sulphur content)		Plant-specific The cost may be disproportionate in the case of existing plants operated < 1 500 h/yr	About 40 European plants of [3, LCP TWG 2012] are fitted with SCR. See graphs below for further examples
Selective auto-catalytic reduction (SACR)	Few large-scale demonstrations	Reduction of NO _x emissions	Emerging technique	NA	New technique for NO _x reduction		NA	NA
Combined techniques	See Section 3.2.2.4	Reduction of NO _x and SO ₂ emissions	Very limited	Depends on the individual process	Generally applicable, but rarely applied	Applicable on a case-by-case basis, depending on the fuel characteristics and combustion process	Not available	NA
NB: NA: No relevant specific information available.								

Environmental performances and operational data for NO_x emissions

The actual achieved level of NO_x emissions may depend on the type of combustion process (e.g. pulverised combustion or grate firing vs fluidised bed combustion), the type of fuel fired (coal vs lignite) or on the plant size. For the sake of assessing the level of NO_x emission associated to the implementation of the different aforementioned techniques, combustion plants have been grouped into homogeneous categories.

Figure 5.37 shows NO_x emissions to air from well-performing coal PC boilers of ≥ 300 MW_{th}. Reported plants are sized between 330 MW_{th} and 1 420 MW_{th}, operated between 3 000 h/yr and 8 200 h/yr, with an equivalent full load factor above 65 %. These plants were commissioned between 1963 and 1999, except Plant 253V that was commissioned in 2008, and use an SCR in combination with one or various primary techniques for reducing NO_x emissions. Plant 367 implements LNBs, air staging and SCR; Plant 34V implements LNBs, air staging, FGR and SCR; Plant 253V implements fuel and air staging, LNBs and an SCR. Plant 367 burns 15 % wood, Plant 219 burns 2 % waste and Plant 662 burns 1 % natural gas and 0.2 % waste. All the plants monitor their NO_x emissions continuously. The short-term (half-hourly or hourly) averages provided range from 45 mg/Nm³ to 190 mg/Nm³ over a year (5th – 95th yearly percentiles) except in one case (Plant 223 - 95th yearly percentile of daily average of 350 mg/Nm³). CO emissions are generally kept well below 100 mg/Nm³ and NH₃ slip below 3.5 mg/Nm³ as a yearly average from continuous monitoring or periodic measurements (2 to 6 times per year).

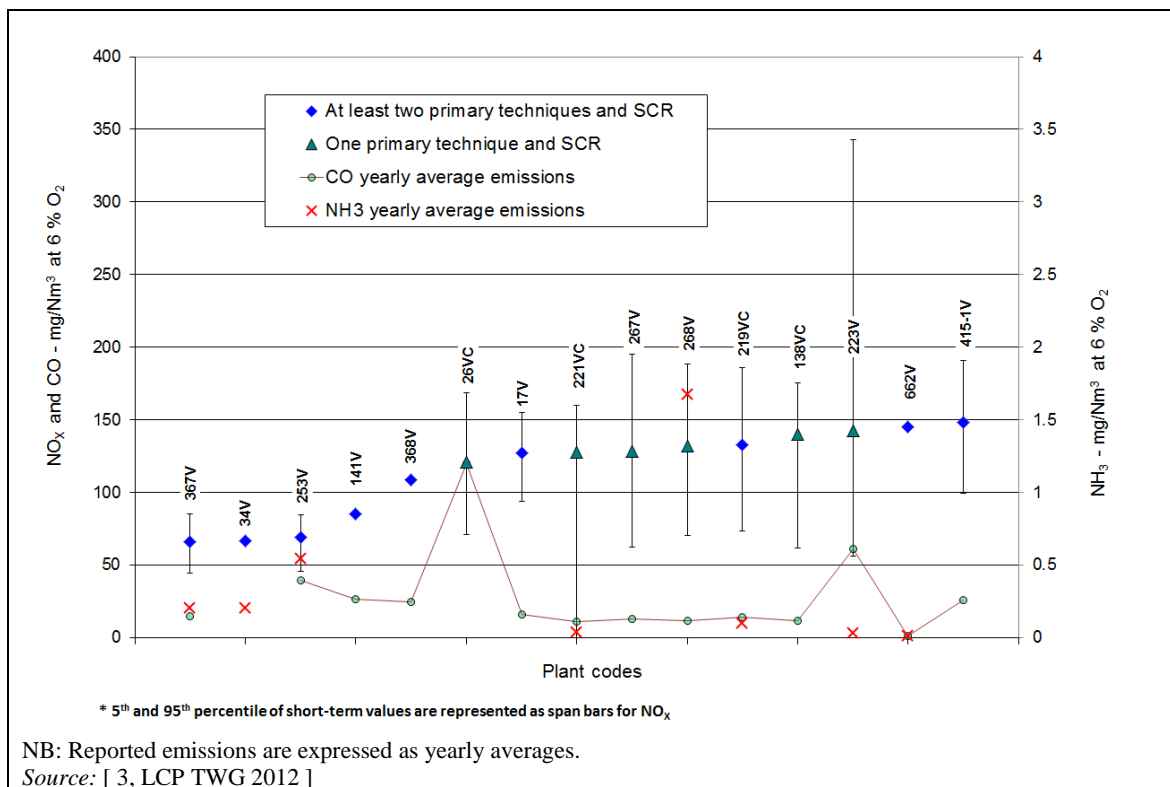

Figure 5.37: NO_x emissions from well-performing pulverised coal boilers of more than 300 MW_{th}

In addition to Figure 5.37, it should be noticed that some coal PC boilers of ≥ 300 MW_{th} fitted only with a combination of primary techniques report NO_x emission levels below 340 mg/Nm³, down to 196 mg/Nm³ (Plants 386-2/3, Plants 478-1/2, Plant 441-1). Furthermore, information was also reported on coal-fired plants of ≥ 300 MW_{th} operated in Japan, China and in the US fitted with SCR and achieving NO_x emission levels < 50 mg/Nm³, although with limited contextual information on the type of associated monitoring or other important parameters. [338, RAP Online 2013], [236, Greenpeace 2015]

Figure 5.38 shows NO_x emissions from well-performing fluidised bed boilers burning coal or lignite and from PC boilers burning lignite falling in the $\geq 300 \text{ MW}_{\text{th}}$ category, with sizes ranging from $330 \text{ MW}_{\text{th}}$ to $2465 \text{ MW}_{\text{th}}$. Plants 117-2 and 127(-1 and -2) are bigger than $2000 \text{ MW}_{\text{th}}$ whereas the others are smaller. They operate between 3 500 h/yr and 8 145 h/yr, with an equivalent full load factor above 80 %, and were commissioned between 1989 and 2006. Among these plants, lignite-fired boilers use a combination of primary techniques, and coal-fired fluidised bed boilers use SNCR or a combination of primary techniques. Plant 377 burns 8 % sludge, Plant 224 burns 15 % indigenous coal and 18 % wood. All these plants monitor their NO_x emissions continuously. The hourly averages provided range from $57 \text{ mg}/\text{Nm}^3$ to $320 \text{ mg}/\text{Nm}^3$ over a year (5th – 95th yearly percentiles). CO emissions are kept, in general, below $100 \text{ mg}/\text{Nm}^3$, except for Plant 99 (up to $140 \text{ mg}/\text{Nm}^3$). The only NH_3 slip concentration reported with SNCR use is $2 \text{ mg}/\text{Nm}^3$, as a yearly average from continuous monitoring (Plant 69).

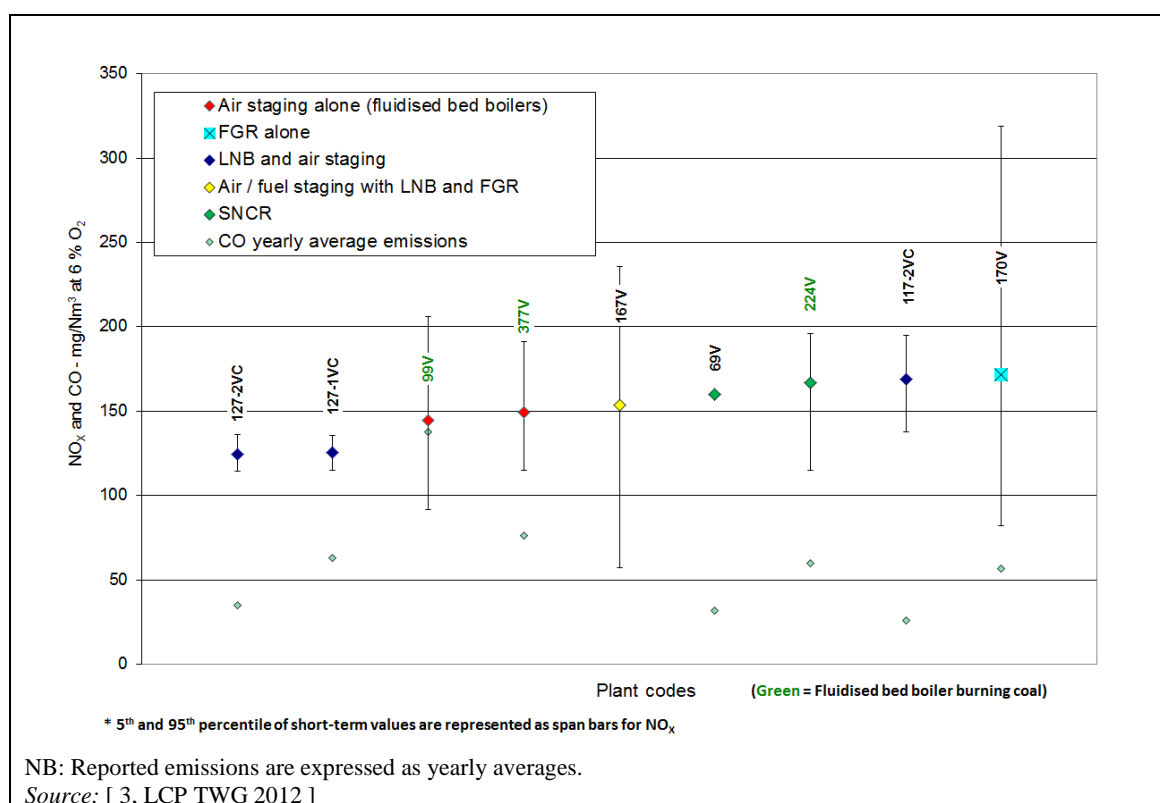

Figure 5.38: NO_x emissions from well-performing pulverised lignite boilers and coal or lignite fluidised bed boilers of more than $300 \text{ MW}_{\text{th}}$

In the US, several lignite-fired plants falling within this size category have been retrofitted with SCR. Emission data from 2012–2014 indicate that two pulverised units sized 800 MW_e retrofitted with SCR at Oak Grove have consistently achieved a level of $60 \text{ mg}/\text{Nm}^3$, and one pulverised unit sized 556 MW_e at Sandow retrofitted with SCR in 2009 showed stable yearly average levels of NO_x emissions of about $80\text{--}90 \text{ mg}/\text{Nm}^3$. Other old (commissioned in the 1970s) pulverised combustion boilers burning lignite supported by US PRB (Powder River Basin) coal were retrofitted with primary techniques (LNB, air staging) in combination with SNCR allowing them to achieve, in general, yearly average levels of NO_x emissions of about $145\text{--}180 \text{ mg}/\text{Nm}^3$ (Bir Brown and Monticello power plants, sized about $1500 \text{ MW}_{\text{th}}$). Two CFB boilers burning lignite, sized about $725 \text{ MW}_{\text{th}}$, were also recently retrofitted (2009) with SNCR (Sandow power plant), allowing them to achieve yearly average levels of NO_x emissions of about $80 \text{ mg}/\text{Nm}^3$ [334, EEB 2014]. In Europe, a new 600 MW_e lignite-fired plant put into operation in 2015 in Slovenia at Sostanj (unit 6) is fitted with SCR. The fuel quality may have

an impact on the design or operation of an SCR system applied at a lignite-fired plant, e.g. more frequent replacement of the catalyst may be required than in the case of a coal-fired plant.

Looking at smaller size categories, two example plants (Plant 25-1V – an atmospheric fluidised bed boiler commissioned in 1996 - and Plant 109V – a grate-fired boiler commissioned in 2004) sized between 100 MW_{th} and 300 MW_{th}, fitted with primary techniques (air staging and FGR) in the case of the fluidised bed boiler or with SNCR in the case of the grate-fired boiler, achieve yearly average NO_x emissions between 155 mg/Nm³ and 172 g/Nm³, with CO emissions below 100 mg/Nm³.

Two example plants (Plant 19V – lignite-fired atmospheric fluidised bed boiler, commissioned in 2010 - and Plant 404V – coal-fired dry-bottom boiler, commissioned in 1995) sized between 50 MW_{th} and 100 MW_{th}, not fitted with any specific technique in the case of the lignite-fired fluidised bed boiler or fitted with primary techniques (air staging and LNB) in the case of the coal-fired PC boiler, achieve yearly average NO_x emissions between 190 mg/Nm³ and 268 mg/Nm³, with CO emissions below 100 mg/Nm³. Two other example plants in this size range, co-firing waste and/or biomass with coal as the main fuel, report yearly average NO_x emissions between 130 mg/Nm³ and 260 mg/Nm³, with CO emissions between 30 mg/Nm³ and 130 mg/Nm³ (coal-fired grate-firing and coal-fired atmospheric fluidised bed boiler, commissioned respectively in 1964 and 1993, fitted respectively with SNCR and a combination of air staging, flue-gas recirculation and SNCR, operated about 4 000 h/yr with an equivalent full load factor higher than 85 %).

5.1.3.6.2 Thermal input biasing and dynamic classifiers for the prevention and control of NO_x at downshot boilers combusting low volatile coals

Description

Optimisation of the heat distribution in the furnace by controlling the burner firing pattern together with the use of dynamic classifiers.

Technical description

This technique involves optimising the heat distribution in the furnace by controlling the burner firing pattern (*thermal input biasing*). Air is admitted to some out-of-service burners (similar to overfire air) and the downshot-fired arrangement facilitates the mixing of this air with the combustion gases to help to achieve carbon burnout.

The technique can be used with reduced air supply to the burners, with emissions achieved similar to those expected for overfire air, i.e. under 1 000 mg/Nm³.

The operation of thermal input biasing is improved by the use of a NO_x advisor system. This system provides operator guidance to achieve the lowest NO_x set-up (with starting and stopping of individual burners), which facilitates optimisation of NO_x but can be constrained by fuel type and drum level issues.

The operation of thermal input biasing (TIB) is improved by the use of dynamic classifiers. These achieve better control of the Pulverised Fuel (PF) size distribution between burners, requiring fewer burners in service for a given load under certain fuel conditions.

Achieved environmental benefit

These improvements can give combined benefits of reduced carbon-in-ash losses, lower dust emissions and reduced NO_x emissions.

Environmental performance and operational data

TIB is capable of reducing NO_x emissions by around 20 % giving an emission concentration of under 1 200 mg/Nm³ at downshot boilers combusting low volatile (< 10 %) coals.

Emissions of NO_x are expected to be further reduced by about 5 % when using dynamic classifiers compared to TIB only, but with greatly improved carbon burnout and lower dust emissions.

Technical considerations relevant to applicability

The ability to run dynamic classifiers is compromised by wet, low calorific value fuels that require the majority of burners to be in service, taking away some ability for thermal input biasing and thus increasing NO_x emissions.

Cross-media effects

Operating issues include increased carbon-in-ash, risk of increased dust emissions, some coal restriction and the risk of furnace wall tube failures.

Undertaking thermal input biasing too aggressively also brings about safety and integrity concerns in the boiler, unbalancing the drum level and resulting in localised high component temperatures potentially leading to operating above safe operating limits.

When using dynamic classifiers together with TIB, there is an increased risk of periods of increased carbon-in-ash, high dust emissions, or increased slagging in the boiler.

Economics

The costs of TIB were calculated to be: [2012 estimation – 10-year lifetime]

Present value cost, million GBP	8.16
Equivalent annual cost, million GBP/yr	1.33

Driving force for implementation

No information provided.

Example plants

No information provided.

Reference literature

[62, UK-TWG 2012]

5.2 Combustion of biomass and peat

5.2.1 Applied processes and techniques

5.2.1.1 Fuel characterisation of biomass and/or peat

Measurements of the fuel characteristics are performed by chemical and mechanical analysis, either by the plant operator or by the fuel supplier (and supplied to the operator).

In a typical fuel characterisation exercise and quality control procedure, the supplier or the operator collects representative short-term fuel samples, e.g. daily, in accordance with EN 14778-1:20011 - Sampling of Solid Biomass. Daily fuel samples are analysed for a range of parameters, including moisture and net calorific value. A monthly (or weekly) composite sample of biomass is then created using the daily composite samples. The monthly biomass sample is analysed for further parameters, such as ash, sulphur, nitrogen and carbon content. The number of measurements reflects the number of days a daily fuel sample is collected when the plant is operational. The fixed carbon is calculated by subtracting the percentages of moisture, volatile matter, and ash from a sample mass.

The list of parameters to be determined (with their limit values) is given in the product declaration of the fuel as part of the contract. For fuel properties, see Section 5.2.2.1.

[3, LCP TWG 2012]

5.2.1.2 Fuel pretreatment and preparation

The moisture content of some biomass fuels can be high. One way to increase the efficiency of the plant is fuel drying, which can be done safely in the fuel feeding system to avoid storage of dried fuel. Steam dryers offer advantages when connected to the steam cycle, particularly in CHP production, where the drying energy can be fully regenerated to heating. However, despite the efficiency benefits, regenerative fuel drying systems have seldom proved economically attractive. Wood chips and bark are often combusted directly without any pre-drying. Special travel, reciprocating and vibrating grates are used for direct combustion of wood chips. Also, CFB and BFB boilers use peat and wood directly without any pre-drying.

Dryers using the flue-gas as a source of heat could also be envisaged. However, the possible generation of organic emissions, such as wax and aromatic compounds, can cause problems, as wax sticks to the flue-gas channels and creates a potential fire risk in the electrostatic precipitator, and aromatic compounds can cause odour nuisances for neighbours.

In several cases, presses are used to remove the moisture from bark fuels. However, unless the press is maintained and operated properly to reduce moisture levels below the level of around 50 %, then the side effects of these pretreatment techniques (high Biochemical Oxygen Demand (BOD) releases to water, and high energy use and maintenance requirements) may offset the gains in combustion efficiency that can be expected from the pretreatment.

Belt dryers can also be used for the drying of solid biomass and biofuels. In the belt dryer, warm air or flue-gas is led through a fuel bed on a moving cloth, on which the fuel dries. Belt drying is a feasible drying method when suitable flue-gas or suitable energy to produce warm air is available.

The moisture level of biomass and peat pellets and briquettes is typically < 10–15 %, so further treatment to reduce the water content is generally not needed.

Straw bales are transported from the storage area by a crane and tier conveyors, and are shredded, cut or milled before they are fed into the boiler furnace. It is beneficial to keep the straw on the fields for some time after harvesting, because rainfall decreases the amount of

water-soluble alkalis in the straw ash. These alkalis are detrimental to the combustion conditions as they lower the ash melting temperature, which then increases the sintering risk of the fluidised bed and fouls the boiler. The amount of water-soluble alkalis present in the fuel can substantially affect the corrosion rate of the superheaters. Rain also recycles water-soluble alkalis back to the soil for the growth of new crops. No other drying of straw besides the natural drying on the fields is practised.

The use of pelletised biomass is increasing, particularly for use in co-firing and in conversion of coal plants to biomass. Many different types of biomass can be pelletised including wood, miscanthus and straw but the greatest usage is likely to be in wood using forestry residues and thinnings as the main fuel source. The pelleting of biomass uses energy and increases the cost of the product although this disadvantage is counterbalanced by the ease of transport, handling and storage, and by the lack of phytosanitary requirements. The moisture content of biomass pellets is low (around 10 %) since most of the pretreatment occurs during the pelleting process.

[86, Eurelectric 2013]

Straw used for pulverised fuel boilers is often milled to dust in hammer mills, which have a high noise level. Attention also has to be paid to noise generation by the subsequent pneumatic transport to the burner.

5.2.1.3 Combustion technologies specific to biomass and/or peat firing

The use of biomass pellets (primarily from wood) enables both the partial and complete replacement of coal in a pulverised fuel boiler. This can produce significant reductions in emissions of NO_x, SO₂ and CO₂.

Many dedicated biomass plants are associated with pulp and paper mills, sawmills, the wood processing industry or wood pellet producers, providing a significant share of the biomass need for the internal processes. In other cases, biomass is sourced from local or regional forests, or agricultural or food manufacturing industries. The co-firing of biomass has been successfully applied at many FBC combustion plants, where the main fuel is coal, lignite, peat or wood residue from the pulp and paper industry. Peat is very often used in Finland and Sweden as a fuel in combination with biomass fuels.

The use of peat may also promote the use of wood. Due to its characteristics, peat is applicable for co-firing with wood. Technically, it would be more difficult to use only some types of wood fuel in existing plants because of corrosion and fouling problems. The ability to burn peat also ensures continuous fuel supply in areas where the availability of wood fuel is insufficient for the fuel demand.

Combustion technologies used for biomass and/or peat firing include grate firing, fluidised bed combustion and pulverised fuel firing.

See Section 2.2 for general information on combustion processes and Section 8.1 for information on multi-fuel firing.

5.2.1.3.1 Grate firing

Grate firing is the oldest firing principle used in boilers. The travelling grate was the most popular firing system in small boilers until the beginning of the 1980s, when fluidised bed combustion started to become more popular, largely replacing grate firing. In the 1990s, water-cooled vibration grates were introduced for mainly straw and wood chip firing, for heat inputs of 28–150 MW. Today, most new solid-fuel-fired boilers with a fuel input of over 15 MW are

fluidised bed boilers, moving grate boilers or pulverised fired boilers. The choice of technology largely depends on the specific size of the boiler and the desired range of fuels.

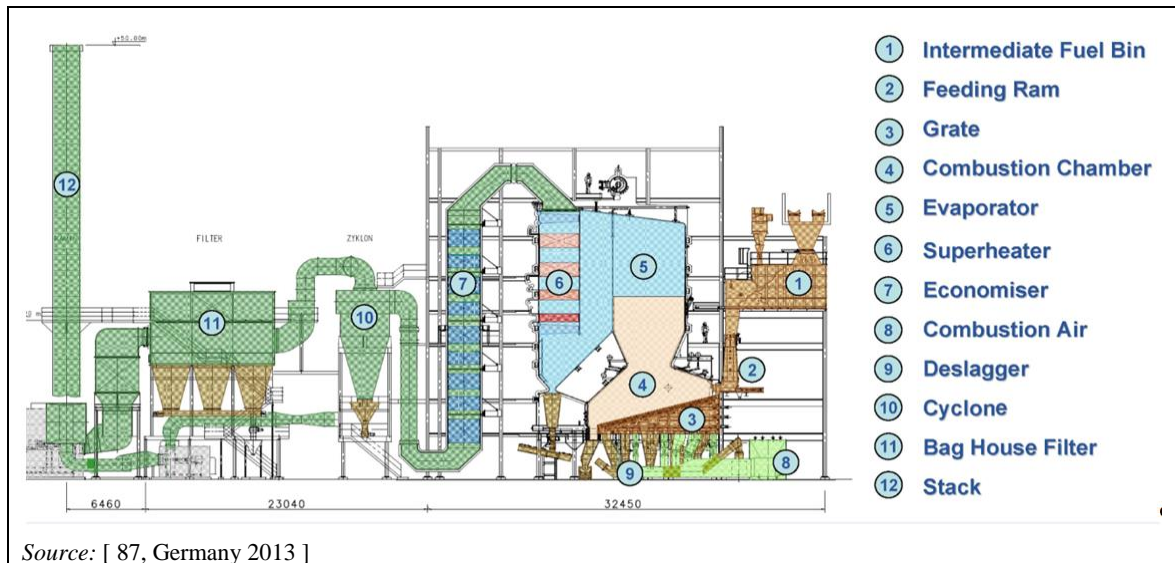

Figure 5.39: Water-cooled vibrating moving grate system with sloped grate boiler for biomass combustion

The typical operating principle in the grate firing of biomass fuels differs from that of coal. Sloped grates are typically used for biomass fuels (see Figure 5.39). They can be static or mechanically activated. If travelling grates are used, a homogeneous layer is fed on to it. As an alternative, the fuel can also be fed onto the grate by a so-called spreader, located on the furnace wall (e.g. spreader stoker system, see Figure 2.10).

Although originally invented as a coal-firing technology spreader stoker combustion is particularly suited to biomass combustion and is typically used in boilers up to 150 MW_{th}. The combination of suspension and grate firing allows the use of a wide variety of fuels, including high-ash fuels and fuels with a high content of fine particles. The staged combustion system with relatively low primary airflow is well suited to biomass fuels as they have a high volatiles content.

Spreader stoker travelling grate combustion systems are generally robust systems that can also handle 'difficult' biomass fuels, e.g. with low melting point ash, as the grate itself is not sensitive to slagging and fouling.

For the co-firing of straw with coal, a number of conversion technologies are possible, but if straw is the only fuel, grate firing is the most common solution. This is mainly due to the slagging/sintering tendency of straw. By taking some special precautions, such as the use of special bed material or additives, FBC plants have also been used for straw firing.

Normally, a vibrating water-cooled grate is used, and the steam temperatures have to be kept below approximately 540 °C to keep corrosion within acceptable limits. Indeed, because of the generation of HCl, straw firing leads to a high risk of high-temperature corrosion, particularly in the superheater section of the boiler. However, experience shows that proper design and proper choice of materials increase the lifetime to above 10 years. The superheaters need to be designed with very large spacing, due to the formation of deposits. The hottest superheaters are not cleaned with soot blowers, as the deposits on the surface create a protective layer against corrosion. [43, EPPSA 2012] [154, CBT 1998] [155, Sanders 2000]

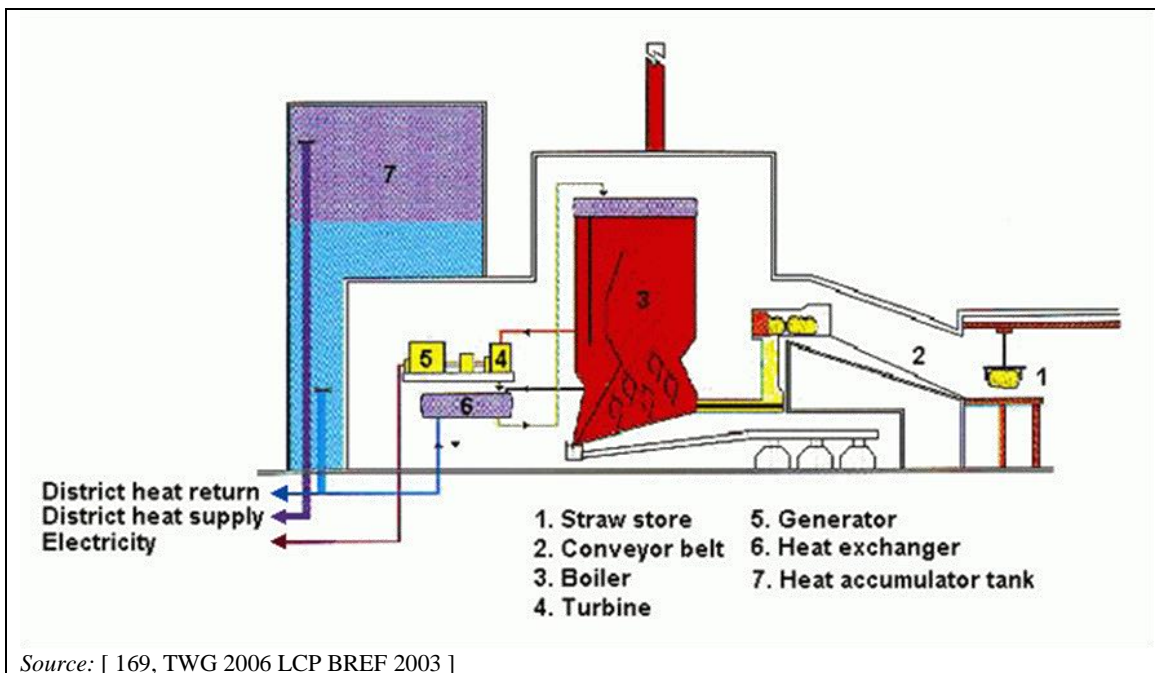

Figure 5.40: Straw-firing combustion plant

In order to attain the optimum efficiency or fuel utilisation, the target is to achieve the best possible burnout. The actual burnout and hence the content of unburnt carbon-in-ash depend mainly on the fuel characteristics and on the combustion conditions. Since biomass generally has a low ash content, the unburnt carbon in bottom ash and fly ash is typically above 10–15 %.

5.2.1.3.2 Fluidised bed combustion

In the 1980s, the FBC technology entered the peat- and biomass-firing markets. Biomass-fired boilers typically have a rated thermal input of up to 500 MW, and can produce both electricity and heat for the local industry or for a district heating system. Boilers with higher rated thermal inputs are used in the multi-fuel firing of other fuels with biomass.

Bubbling fluidised bed combustion (BFBC) is a combustion technology especially suited for burning inhomogeneous biomass fuels. BFBC is more commonly applied for the combustion of biomass and/or peat in smaller boilers. HFO, gas oil or natural gas are commonly used in bubbling fluidised bed (BFB) boilers as a start-up fuel and as a support fuel during boiler operation, e.g. during malfunction of solid fuel supply or to compensate for solid fuel quality variations (biomass and/or peat moisture variations).

Circulating fluidised bed combustion (CFBC, see Figure 5.41) is more common in larger plants, but is also used on a smaller scale where fuel flexibility is required.

Peat-fired boilers are usually also designed to combust other low calorific value fuels, and sometimes coal. Natural gas, heavy fuel oil or gas oil are commonly used as auxiliary start-up fuels. [3, LCP TWG 2012] [43, EPPSA 2012]

In addition, many of the older steam generators that use pulverised peat burners with associated peat dryers have been rebuilt to use FBC. FBC offers high fuel burnout and efficiency, is tolerant of fuel quality changes, and does not require fuel drying and pulverising.

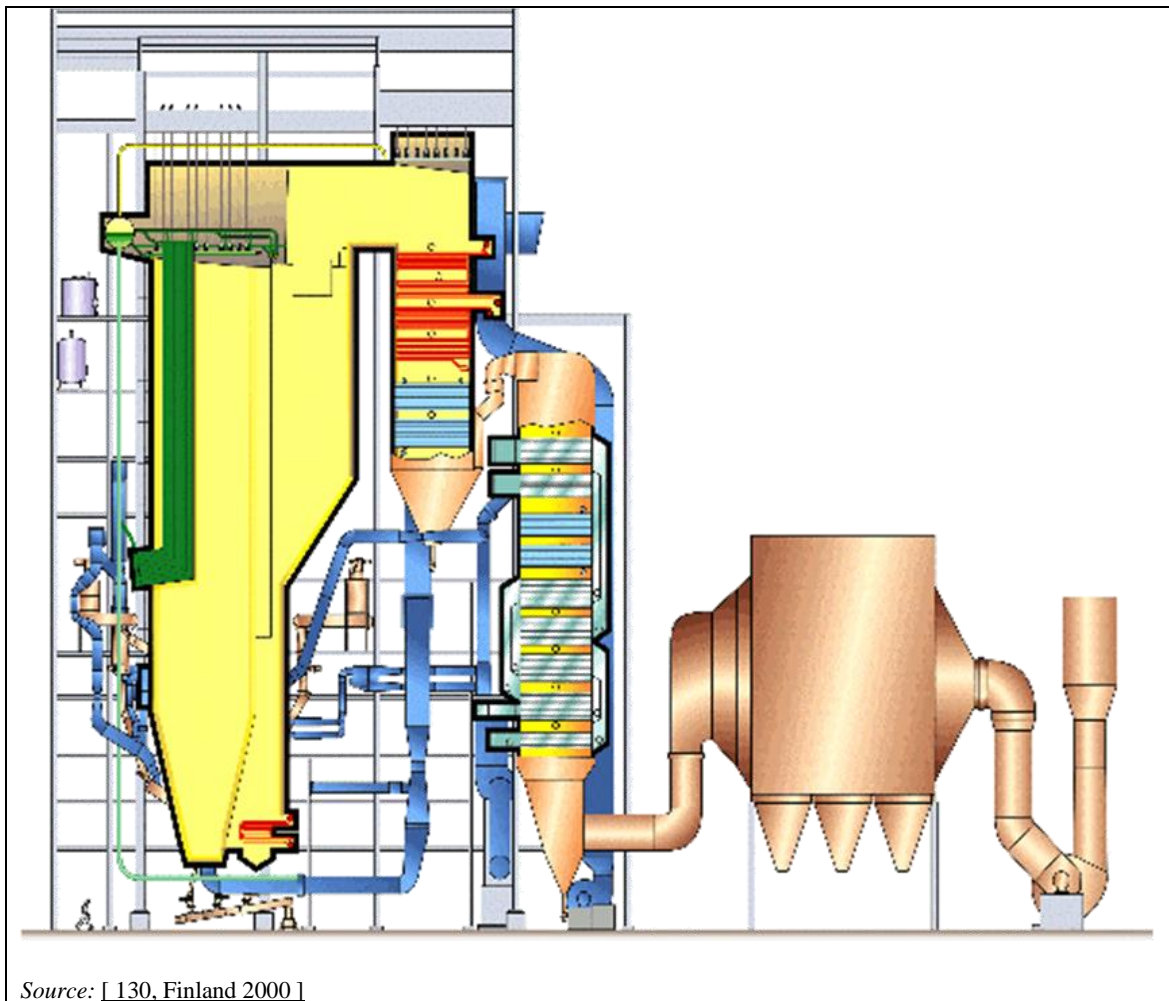

Source: [130, Finland 2000]

Figure 5.41: Biomass-fired circulating fluidised bed boiler

5.2.1.3.3 Pulverised peat and/or biomass firing

In the late 1970s, pulverised firing, being the standard technology for coal, was the most mature combustion technology. Consequently, most large peat-fired power plants in the 1970s and in the first half of the 1980s were based on boilers with pulverised firing. Pulverised firing of reactive fuels such as peat proved problematic because of difficulties in the drying systems and in emission control, and because of the need for a support fuel due to the changes in fuel quality and in emission control.

Starting mainly from the conversion of coal-fired plants to biomass-fired plants, pulverised fuel-firing systems using pellets with heat inputs up to 800 MW were introduced starting from the mid-1990s.

Pulverised combustion is also used for wood firing. Plants grinding wood pellets and using pulverised firing currently have a broad thermal input range (60–800 MW_{th}) [3, LCP TWG 2012], and large-scale utility boilers firing biomass with a high plant efficiency are feasible.

Compared to fluidised bed combustion, the limiting factors are the lower suspension density and the slagging effects caused by the higher furnace temperature than in fluidised bed combustion. [3, LCP TWG 2012] [43, EPPSA 2012]

Pulverised biomass firing requires dry fuel and a very small particle size. The cost and energy consumption of fuel preparation are considerable compared to other biomass-firing techniques. [88, Denmark 2013]

In order to convert units to enable dedicated combustion of biomass, it may be necessary to develop biomass receipt, storage, and handling systems, and facilities to distribute the biomass to the boilers which need to be specifically designed to ensure that there are no significant arisings of dust from the process and combustion systems. The fundamental principles of operation of the plant may remain unchanged through the conversion process but a significant number of plant components need to be optimised in order to maximise the thermal efficiency of the plant and minimise emissions. These optimisations include: burner modifications to ensure that the burners perform in a way that maintains a reliably detectable flame with good combustion stability; modifications to combustion air systems to reduce the temperature of the air entering the mills and to reduce the boiler gas exit temperatures; modifications to mills in order to process the wood pellets to the required particle size to ensure efficient combustion; modifications to the fuel delivery system to safely transport the wood pellets from storage to the mills; and modifications to the electrostatic precipitator (ESP) hoppers to improve the handling of the ash collected from the converted units. [86, Eurelectric 2013]

5.2.1.4 Energy efficiency of biomass- and/or peat-fired LCP boilers

Cogeneration plants are economically feasible at much smaller plant sizes than condensing power plants (see Section 2.2 for general information on processes for energy generation). They are also particularly suitable for biomass and/or peat combustion. With a smaller plant, the biomass and/or peat fuel can be collected over a smaller area, which helps limit the costs and the environmental impact of fuel transport, usually a major element to consider with plants firing biomass and/or peat.

Biomass- and/or peat-fired plants are often suitable for combined heat and power applications as they are generally of a size that can be well matched to local heat demand in industry, district heating schemes, etc., as opposed to larger utility size plants where the recoverable heat commonly exceeds local heat demand. Indeed in 2010 about 72 % of the peat used in large combustion plants in Finland, and 93 % of the biomass, was used in CHP production. Conversely, in Ireland peat is used only for electricity production.

When biomass is used in existing large-scale pulverised fuel utility boilers, a high plant efficiency can be achieved. However, the temperature distribution within the boiler changes. These changes to temperature distributions inside the boiler and modifications to air transport characteristics may cause minor reductions in the efficiency of a fully converted unit compared to a coal unit operating at the same load factor. [86, Eurelectric 2013]

5.2.1.5 Control of emissions to air from biomass- and/or peat-fired plants

5.2.1.5.1.1 Control of nitrogen oxides emissions

The low combustion temperatures of grate systems are advantageous for the control of NO_x emissions. Overfire air is commonly used to reduce the generation of NO_x emissions. Spreader stoker firing usually also employs low excess air as a primary NO_x reduction measure.

NO_x emissions in fluidised bed combustion are usually noticeably lower than in conventional pulverised fuel combustion. The combustion temperature in FBC is typically low (e.g. when burning peat), which ensures a low level of thermal NO_x formation. Under these conditions, most of the NO_x emissions are caused by fuel-bound nitrogen.

The combustion characteristics of biomass in fully converted boilers are yet to be fully described. Examples of coal plants converted to biomass (e.g. Plant 14—retrofitted) using SCR are provided in the LCP TWG 2012 data collection. At low degrees of biomass co-firing (< 50 % by thermal input), the influence on NO_x emissions is low. However, at higher co-firing degrees (> 50 %) the combustion processes and abatement techniques, and the achievable emission levels, are significantly influenced by the type and volume of the biomass. When using existing coal burners and control systems within boilers, the stability of the flame within the boiler can be changed. This may require modifications to air/fuel distribution and hence to the NO_x reduction capability of the burner. [86, Eurelectric 2013]

NO_x emissions can be reduced by primary techniques (e.g. staged air supply system) and/or use of SNCR and/or SCR. NO_x reduction techniques in biomass combustion may require a sophisticated secondary air system and a special furnace design enabling two combustion zones. The NO_x formation can be further limited by minimising the excess air ratio and by staging the combustion air. In modern boilers, secondary air ports are installed in addition to the primary fluidising air inlets. Some combustion air is injected through these ports, which are located in the upper part of the furnace. Secondary/tertiary air injected through the upper air ports ensures a complete burnout. The lower part of the furnace can then be operated with a low air ratio, which inhibits NO_x formation. Additional primary techniques such as the recirculation of the flue-gases, may also be installed to reduce NO_x formation.

The formation of nitrous oxide (N₂O) appears to be greater in FBC (especially in circulating fluidised beds) than in conventional pulverised fuel combustion.

Secondary techniques such as selective catalytic or non-catalytic reduction have been applied to many biomass- and/or peat-fired boilers, especially new boilers. SNCR has been widely used and is now a well-established technique for biomass firing. For existing boilers, if SNCR has not been applied during boiler design, SNCR may be less effective due to the lack of a suitable temperature window. The process design or the high heat load of an existing boiler can lead to too short a reaction time because of too high temperature in the upper part of the furnace for ammonia/urea injection.

SCR was introduced in the mid-1990s; combinations of SNCR and SCR are also applied, e.g. when the efficiency of SNCR is constrained by a short reaction time in the boiler or load variations. Small grate boilers can also be fitted with SNCR, or even with low-dust SCR. SCR requires sufficiently high temperatures to work and to avoid ammonium bisulphate formation. Low-dust (tail-end) SCR can be installed at flue-gas temperatures of 190 °C and upwards. High-dust SCR can operate safely from temperatures of 320 °C and upwards. The fuel mix palette used and desired load level of the boiler are the key issues when planning an SCR in an existing boiler. The main challenges are layout, ductwork, flue-gas draft system and structural changes. Space availability for the catalyst and layout modification of the flue-gas duct need to be considered for an SCR retrofit. [89, EPPSA 2013]

High-dust SCR is applicable for the pulverised combustion of woody biomass, but the use of high-alkali fuel (e.g. straw) may require low-dust tail-end SCR due to the catalyst poisoning potential. Once deactivated, the SCR catalysts need to be regenerated. This can be achieved (e.g. every second year) by washing the catalyst with water (and/or sulphuric acid), after taking it out of the system. However, *in situ* washing with water followed by sulphation (treatment with SO₂ gas) is also possible. [43, EPPSA 2012]

5.2.1.5.1.2 Control of SO_x emissions

At combustion plants using biomass and/or peat, the sulphur content of the fuel is often low or moderate. Therefore, emissions are frequently so low that often no desulphurisation is applied.

However, with higher sulphur content biomass or peat, post-combustion dry injection processes are usually applied. The injection of calcium hydroxide or sodium bicarbonate in a dry form before a bag filter can achieve sufficient SO_x emissions reduction. However, sorbent use increases the amount of ash produced by the combustion plant, and therefore it may also increase particulate emissions if an ESP rather than a bag filter is used for dust removal. There is the possibility that the sorbent properties may reduce the electrostatic precipitation efficiency, causing higher dust emissions, especially when using larger amounts of sorbent to reduce SO_x emissions.

Limestone injection in the furnace of pulverised fuel plants, together with a wet scrubber, can also be an effective solution in some cases.

Sulphur removal on the grate is not possible because of the minimal contact time between the SO_x and the reactive alkali fed onto the grate. Limestone injection into the furnace is possible, but is not efficient in grate-firing boilers. In the case of grate-fired boilers, sorbent injection in the flue-gas duct before a bag filter is therefore the most commonly applied technique. The type of sorbent depends on the flue-gas temperature. Limestone is used up to 150 °C, and sodium bicarbonate is used above this temperature. [89, EPPSA 2013]

Sulphur emission reduction in pulverised fuel combustion can be achieved by limestone or dolomite injection in the furnace, but the method is very inefficient and uneconomical. It is even possible that chlorine corrosion is amplified by these adsorbents.

These measures also remove other harmful emissions, such as HCl and HF. [43, EPPSA 2012]

Given the relatively low sulphur content of the fuels which are expected to be burnt in a plant converted from coal, an expected 90 % reduction in sulphur emissions can be expected with the conversion thereby providing an effective primary measure for the reduction of emissions of sulphur dioxide. It is also noted that the FGD fitted for the desulphurisation of coal may be inefficient and ineffective if retained to attempt to further reduce emissions from a unit converted to biomass. Power plants converted from coal generally have an FGD system but these have been designed for use with high-sulphur coals and there are concerns that for engineering reasons it would not be practical or economic to operate a converted unit with an existing FGD system. This is especially the case where conversion leads to higher back-end temperatures with implications for the FGD system integrity. [86, Eurelectric 2013]

5.2.1.5.1.3 Dust control

When burning biomass (e.g. wood, straw) or peat in grate combustion systems, most of the ash is left on the grate and collected as bottom ash. Only a small quantity of ash leaves the furnace as fly ash and is collected in the dust reduction devices. For dust abatement from grate-fired combustion plants, both ESPs and bag filters are currently applied, with the bag filter being the more common.

In pulverised biomass or peat combustion, the bulk of the ash is carried with the flue-gas out of the combustion chamber. Only a small quantity is collected as bottom ash.

For large pulverised biomass/peat combustion plants, the ESP is the most commonly used technique. Bag filters may also be used.

For dust abatement in biomass and/or peat-fired fluidised bed combustion boilers, both ESPs and bag filters are currently applied, with the bag filter often the preferred technique for plants using dry sorption techniques and the ESP more often applied in cases where solid fossil fuel plants were converted to be dedicated biomass plants. The resistivity of the ash of certain fuels (i.e. straw) may influence the efficiency of the ESP depending on the fuel mix used in the combustion.

For fluidised bed systems, the fuel is used in a coarsely ground form and for this reason most ash is extracted as bottom ash. In CFBC, the bed zone is expanded by the higher airflow velocities, and ash (necessary for this type of combustion) has to be recirculated. Centrifugal precipitation is an integral component of CFBC to recover coarse ash particles, as shown in Figure 5.42.



Figure 5.42: Fuel and bed material flow in a biomass-fired CFBC boiler

5.2.1.6 Water and waste water treatment

Pollutant emissions to water are not a major problem for biomass and/or peat combustion plants. See Section 3.2.4 for general applied techniques in combustion plants for the control of emissions to water.

5.2.1.7 Management of combustion residues

A peat-fired power plant produces ash and products from limestone injection. Most of the ash is fly ash from the flue-gas cleaning system (electrostatic precipitators or bag filters). Some 10–20 % of the total ash amount is bottom ash at the bottom of the boiler. This may be used as indicated below or disposed of, depending on the applicable legislation and market conditions.

Peat ash can be used as a raw material, as an additive in the construction and building material industry or for example as a road construction material. In the stabilisation of mineral aggregates and in concrete, peat fly ash can be utilised to replace either the finest aggregate material or part of the cement. It may also be used in sewage treatment. The geotechnical properties and mineral constituents of the ash have to be investigated on a case-by-case basis before commercial use.

Nowadays, peat is seldom fired alone. It is usually fired together with other fuels such as wood, resulting in most cases in producing mixed ash. The properties of such mixed ash are different from those of peat ash and, therefore, the utilisation opportunities are slightly different. For instance, the slightly different composition of the ash resulting from the co-combustion of wood and peat makes it more difficult to use as a construction material.

In some countries, peat fly ash and some biomass ash or a mixture of both may be used as fertiliser in forests and on fields. Ash contains some plant nutrients and lime necessary for plants. However, both environmental and health aspects and regulations have to be taken into account before any commercial use of biomass and/or peat ash as a fertiliser is allowed.

The fly ash from straw combustion units is usually disposed of, primarily due to its high content of cadmium. The bottom ash, though, could be applied on fields or used as a road construction material.

The majority of coal plants converted to biomass generate fly ash and small quantities of bottom ash which can be used as an additive in the construction and building material industry or may be disposed of.

5.2.2 Current emission and consumption levels

5.2.2.1 Biomass and peat used in large combustion plants

Different types of biomass and peat are often co-fired in variable proportions in the same installation, taking into account fuel availability and process needs. Appropriate fuel mixing can help combustion plants achieve better process and environmental performances. For multi-fuel firing, see Chapter 8; for the fuel characterisation step, see Section 5.2.1.1.

Some coal combustion plants from the UK, Belgium, the Netherlands and other countries have been converted to biomass fuel. [86, Eurelectric 2013]

Biomass is defined in the IED as products consisting of any vegetable matter from agriculture or forestry that can be used as a fuel for recovering its energy content, and the following waste:

- vegetable residues from agriculture and forestry;
- vegetable residues from the food processing industry, if the heat generated is recovered;

- fibrous vegetable waste from virgin pulp production and from the production of paper from pulp, if it is co-incinerated at the place of production and the heat generated is recovered;
- cork waste;
- wood waste with the exception of wood waste which may contain halogenated organic compounds or heavy metals as a result of treatment with wood preservatives or coating and which includes, in particular, such wood waste originating from construction and demolition waste.

Biomass such as bark, wood chips, sawdust, cardboard, fibreboard or other residues from pulp mills or sawmills contains high amounts of water. Although the chemical compositions of the bark and wood of different species are slightly different, and even though the amount of dirt and soil affects the ash content and composition, biomass derived from forestry and forest industries has, in broad terms, certain common qualities as a fuel. The sulphur content is low and the ash content is moderate. The EN ISO 17225 series provide typical values and properties of biomass fuels. Burnt together with peat, for instance, wood ash can react with sulphur from the peat and act as a desulphurising agent. Nevertheless, the differences in fuel moisture and consistency are considerable, and these affect the fuel handling and combustion properties. All these details need to be taken into account when determining techniques for their storage, transportation, combustion, and possible flue-gas treatment.

An emerging class of biomass fuel used by pulp and paper mills and in CHP and heating plants is forestry residues, i.e. small trees, treetops and branches of trees, and sometimes also stumps, which are collected specifically to be used as fuel in connection with other forestry operations. Forestry residues are used as chips or hog fuel. Experimentation has also been ongoing for the last decades into the growing of various short-rotation coppices (e.g. Salix and poplar species) specifically for fuel, although the economics of these fuels are worsened by the costs of collection and transport.

Forestry residues, when they are used, are often co-fired with other fuels at existing installations, particularly at peat or bark residue-fired FBC plants, but plants running mainly or only on forestry residues are also possible. However, not all forestry biomass is suitable for burning, even at FBC boilers designed for peat or bark. [3, LCP TWG 2012]

Straw is a residue from the agricultural production of grain, and indeed most of the annual straw production is consumed within the agricultural sector. Surplus straw is utilised for energy production in either small district heat-producing boilers or larger CHP plants of up to 40 MW_e. Straw is converted to power and heat in conventional combustion plants, but many technical issues have to be considered due to the special characteristics of straw (in particular its high chlorine content). Other biomass fuels used include olive stones, aspen bark, rubber trees, sugar cane bagasse, and reed canary grass. All these fuels have a relatively high alkali (Na, K) content.

Energy generation from peat in the EU is concentrated in six countries: Finland, Ireland, Sweden, Estonia, Latvia and Lithuania. In these six countries the primary energy use is about 1420 TWh per year, and the mean yearly use of peat energy in the period 2006–2009 was 42 TWh, about 3 % of the total primary energy use. In particular, in both Finland and Ireland peat is a significant fuel, making up ca. 5–6 % of primary energy consumption. In the EU-27 as a whole, only is 0.2 % of a primary energy use of ca. 21 000 TWh per year is peat energy.

In Finland, the share of peat energy in district heating is overall 21 %, reaching levels above 30 % in 10 of its provinces. In Estonia and Sweden, this share is 1.2 % and 0.6 % respectively. [90, Finland 2013]

Table 5.39 presents a comparison of biomass and peat with other common fuels.

Table 5.39: Comparison of biomass fuels and milled peat with fossil fuels normally used in LCPs

Parameter	Unit	Steam coal ⁽¹⁾	Milled peat	Bark	Wood ⁽²⁾	Heavy fuel oil	Natural gas
Moisture	%	10	50	55	40	0.5	< 0.1
Ash in dry matter		14	3–6	2–3	0.4	< 0.1	0.0
Volatile matter in dry fuel		25–35	NA	70–80	80–90	NA	NA
Sulphur in dry fuel		< 1	0.5	< 0.2	0.05	< 1	0.0
Nitrogen compounds in dry fuel		1	1.7	0.5	0.5	0.3	0.05
Cl	mg/MJ fuel LHV ⁽³⁾	< 0.1	NA	< 0.03	< 0.01	NA	NA
As		0.14	0.1	0.01	0.01	0.04	NA
Cd		0.15	0.004	0.015	0.01–1.1	NA	NA
Hg		0.003	0.003	0.1	0.001–0.009	< 0.0001	NA
Ni		0.4	0.3	0.04	0.03	0.9	NA
Pb		0.5	0.3	0.15	0.1–0.7	0.06	NA
Fuel bulk density	kg/Nm ³	1350	350	350	200	987	NA
Fuel bulk LHV	GJ/Nm ³	34.3	2.9	2.5	2.1	40	NA
LHV of dry substance	MJ/kg	28.7	20	19	19	40.2	48
LHV		25.5	8.4	7.2	10.4	40.1	48
Stoichiometric flue-gas	Nm ³ /MJ	0.278	0.383	0.435	0.357	0.277	0.297
Stoichiometric dry flue-gas		0.253	0.281	0.291	0.259	0.246	0.239
Specific CO ₂	gCO ₂ /kWh	476.1	658.8	NA	NA	402.5	172.8
Specific CO ₂ per LHV unit	gCO ₂ /MJ	90	106–118	113	100	76	54
Power generated / heat ratio (LHV)		2.3	2.3–2.7	NA	NA	2.3	1.8
Emitted CO ₂ per electric kWh	g/kWh	207	244	NA	NA	175	96

(¹) Polish export coal.
(²) Wood chips.
(³) Order of magnitude figures only.
Source: [130, Finland 2000]

Peat is indigenous in combustion plants. It is a voluminous fuel with a low calorific value like most of the biomass fuels. Therefore, it can rarely be economically transported over distances of more than about 100 km. Thus, a number of plants burning peat and/or biomass consist of small-scale local cogeneration or heat-only plants for small to medium district heating systems. A great number of those plants in Finland are below 50 MW_{th}. As a result of the cost of transporting peat to the plants, although peat bogs deep and large enough for economic peat production exist in all parts of Finland, only a small fraction of them are being exploited. In energy terms, the largest consumers of peat fuel are the cogeneration and heating plants in the district heating systems of (mostly inland) cities with populations of 50 000 to 200 000.

Peat is characterised by low ash and sulphur contents, typically around 5 % and 0.20 % (dry) respectively. Peat has a high volatiles content and is very reactive if its moisture content falls below 40 % (milled fuel peat). For large-scale use, it is typically used as milled peat, produced during May to August, dried around 40 % moisture by the sun and wind on the production site, and subsequently stored next to the production site in large stockpiles, with plastic coverage. With respect to the high moisture content (around 45–50 wt-% at the time of deliveries) and in terms of dry substance, peat is more comparable to biomass than to lignite.

Figure 5.43 shows a typical mass flow balance stream from the combustion of peat at a CFB boiler.

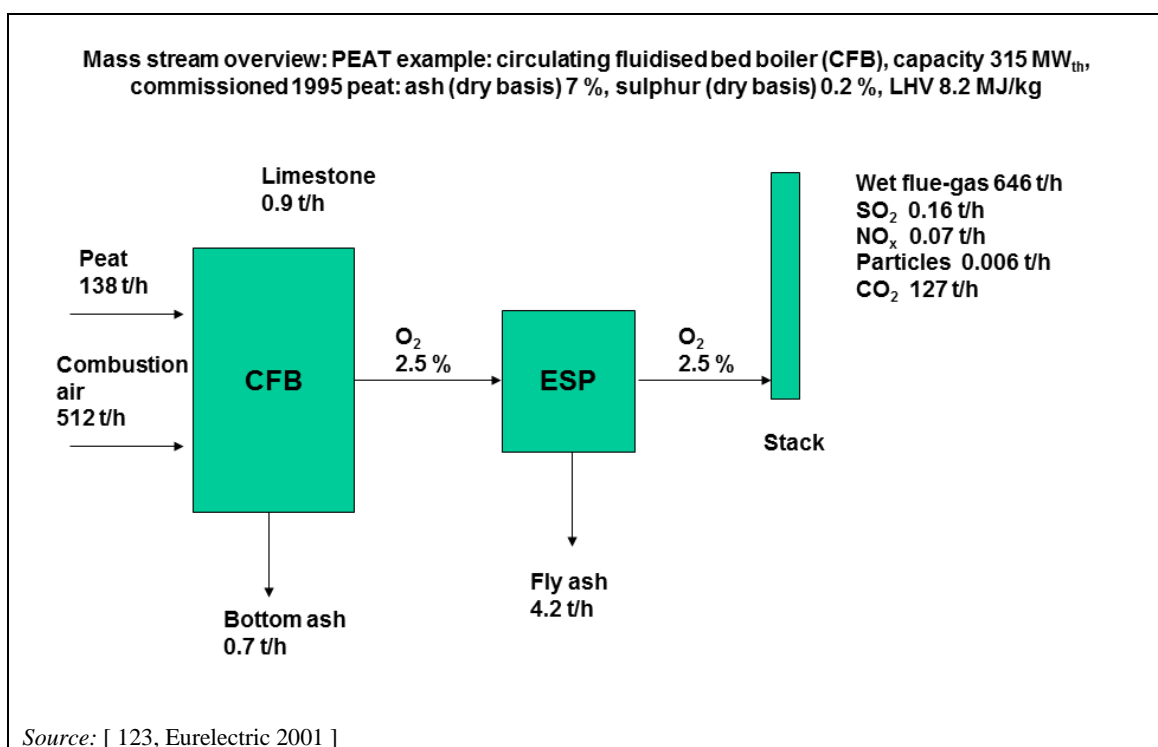

Figure 5.43: Example of the mass flow balance stream of a peat-fired CFBC boiler

5.2.2.2 Energy efficiency of biomass- and peat-fired combustion plants

As mentioned earlier, many biomass- and/or peat-fired power plants are CHP plants. The cogeneration of electricity and heat enables reaching very high levels of total fuel utilisation, which may range from 17 % up to 102 % (yearly average on LHV basis – condensing mode). A typical total fuel utilisation level for cogeneration plants is however difficult to determine on a general basis. The efficiency is highly site-specific and depends on issues such as the heat load and changes in the heat load, the price level and the need for electricity in the market, the applied technology, etc.

The cogeneration of heat and power is usually considered as a technical option whenever economically feasible, i.e. whenever the local heat demand is high enough to warrant the construction of the more expensive cogeneration plant instead of the simpler heat- or power-only plant. Indeed, plants operating for power generation only are also common. The usual power plant net electrical efficiency range is 11–36 % (yearly average), with the higher end of the range related to plants for power generation only. With pulverised combustion, electrical efficiency levels of 38–39 % were achieved in a pulverised peat boiler in Finland.

Biomass- or peat-fired condensing power plants are usually smaller than coal-fired plants, and the steam pressure and temperature are usually lower than in advanced coal-fired power plants. The heat rate levels for biomass- and peat-fired FBC power plants are around 3.3–3.6. [3, LCP TWG 2012]

Conversion of a coal unit to 100 % biomass firing has a slight impact on the overall thermal efficiency of the unit. As the biomass used (e.g. pellets) has a lower moisture content compared to coal, a higher tempering airflow is required at the milling stage, a consequence being that more combustion air bypasses the air heaters. The result of this is a higher flue-gas exit temperature and consequently a small reduction in the overall boiler efficiency. However, the efficiency of a converted unit is closely connected to that of the unit operating with coal. [86, Eurelectric 2013]

5.2.2.3 Emissions to air from biomass- and/or peat-fired combustion plants

The emissions of biomass plants depend mainly on the composition of the fuel, the combustion process used and the flue-gas treatment. NO_x emissions also depend on the combustion characteristics, and in the cases of higher emissions, the NO_x concentrations in the flue-gas can be reduced with a DeNO_x system.

With grate-firing systems for biomass, CO peaks can occur in the vibrating periods of the vibrating grate. [43, EPPSA 2012]

In Table 5.40, the range of currently observed emission levels for the combustion of biomass and/or peat is presented. In some cases, the data reported are specific to biomass fuel only and may not necessarily be representative of both biomass and peat combustion. An indication of the most common abatement techniques applied in biomass- and/or peat-firing combustion plants is also given.

Table 5.40: Specific emissions to air from biomass- and/or peat-fired combustion plants

Capacity (MW _{th})	Type of combustion	Abatement techniques			Emissions to air (mg/Nm ³) ⁽¹⁾							
		SO ₂	NO _x	Dust	SO ₂	NO _x	NH ₃	Dust	CO	HF	HCl	Hg
< 100	GF	DSI/SDA	Air staging/Fuel staging/LNB/Flue-gas recirculation/SNCR	ESP alone or with Flue-gas condenser/Bag filter	3–73	220–303	17–22	2–21	24–79	0.23–0.27	2.2–51	0.0008–0.0075
	FBC	Wet scrubbing/DSI/Flue-gas condenser/Boiler sorbent injection/Wet FGD	Air staging/Fuel staging/LNB/Flue-gas recirculation/SNCR/SCR	ESP alone or with Flue-gas condenser/Wet scrubbing/Wet FGD/Bag filter alone or with Flue-gas condenser	1–850	70–400	1–15	0.5–42	13–373	0.01–0.77	0.15–36	0.0006–0.009
	PC	NI	Air staging/LNB	ESP	4	194–198	NA	22–27	202–286	NI	NI	NI
100–300	GF	Flue-gas condenser/Wet FGD	Air staging	Bag filter with Flue-gas condenser and Wet FGD/ESP	3–376	290–386	NA	1–21	117–251	NI	7–17	0.0003–0.0011
	FBC	Wet scrubbing/DSI/Flue-gas condenser/Boiler sorbent injection	Air staging/Fuel staging/LNB/Flue-gas recirculation/SNCR/SCR	ESP alone or with wet scrubber/Bag filter	1–626	53–400	1–15	1–61	13–928	0.01–1.3	0.2–15	0.0001–0.0039
	PC	NI	Air staging/Fuel staging/SNCR	ESP	2–3	120–248	NI	3–12	12–515	NI	NI	NI

≥ 300	FBC	Flue-gas condenser/ Boiler sorbent injection	Air staging/LNB/ SNCR	ESP	49–371	174–234	2.6	1–15	4–37	0.5	4–37	0.0029
	PC	Wet FGD	Air staging /LNB/ Flue-gas recirculation /SCR	ESP alone or with Wet FGD	1	42–158	1–5	1–8.5	29–38	0.3	4	0.0003

(¹) Data represented are yearly averages of short-term values, without subtraction of uncertainty, dry flue-gas, 6 % reference oxygen.

NB:

NI: No information provided

NA: Not applicable

GF: Grate firing; FBC: Fluidised bed combustion; PC: Pulverised combustion; DSI: Duct sorbent injection; SDA: Spray dry absorber; FGD: Flue-gas desulphurisation

Source: [3, LCP TWG 2012]

5.2.2.4 Combustion and other plant residues

Properties of biomass and peat ashes

Peat ash is formed from mineral matter in peat that is similar to the constituents of sandy soil.

Peat fly ash is a fine powder consisting mainly of particles of variable silica, alumina, and iron oxide (65–75 %). Due to the limestone base underlying the peat bogs, peat ash in Ireland typically contains 25–55 % CaO. Other major species are compounds of the alkaline earth metals (10–55 %) and unburnt peat particles (0–5 %). The fly ash also contains trace elements, i.e. other metals.

The ash content in wood is typically approximately 1 %. Ash from wood firing consists of different minerals/nutrients, unburnt carbon and a small part of trace elements.

The composition of minerals/nutrients in ash from the combustion of a typical wood pellet is given in Table 5.41.

Table 5.41: Composition of minerals/nutrients in ash from the combustion of a typical wood pellet

wt-%	SiO ₂	Al ₂ O ₃	Fe ₂ O ₃	CaO	MgO	Na ₂ O	K ₂ O	SO ₃	P ₂ O ₅	Cl
	41.3	5.5	2.8	27.1	4.8	2.0	9.3	3.6	2.2	1.5
NB: Dry and carbon-free basis. Source: [90, Finland 2013]										

The combustion process applied has an effect on the character of the ash produced, although the quality of the fuel is the key determining factor. The bottom ash from fluidised bed combustion also contains bed sand from the combustion chamber.

Ash from combustion with limestone injection

The ash from fluidised bed combustion with limestone injection contains the end-product of the desulphurisation reaction, unreacted calcium hydroxide, and limestone (about 15 wt-%).

Solubility of ash

The solubility of trace elements in fly ash is an important factor when assessing the potential environmental impacts. The alkaline earth metals (e.g. sodium, potassium) and other mineral elements, like boron and chlorides, are the most soluble compounds. Trace metals in ash are poorly soluble in water.

5.2.3 Techniques to consider in the determination of BAT for the combustion of biomass and/or peat

This section describes techniques (or combinations thereof), and associated monitoring, considered to have the potential for achieving a high level of environmental protection in the activities within the scope of this document. The techniques described include both the technology used and the way in which the installations are designed, built, maintained, operated, and decommissioned.

It covers process-integrated techniques and end-of-pipe techniques. Waste prevention and management, including waste minimisation and recycling procedures, are also considered. Furthermore, techniques for reducing the consumption of raw materials, water, and energy are covered.

Annex III to the Industrial Emissions Directive lists a number of criteria for determining BAT, and the information within this chapter addresses these considerations. As far as possible, the standard structure of Table 3.4 is used to outline the information on each technique, to enable a comparison of techniques and the assessment against the definition of BAT given in the Industrial Emissions Directive.

This section does not necessarily provide an exhaustive list of techniques that could be applied in the sector. Other techniques may exist, or may be developed, which could be considered for the determination of BAT for an individual installation.

In this section, the techniques to be considered have only been fully described when they are specific to the considered combusted fuel or applied combustion process (combustion of biomass and peat). Indeed, for most of the techniques, general descriptions are already presented in Chapter 3. Therefore, in order to avoid repetition, for those general techniques already described in Chapter 3, only the additional information that is specific to the combustion of biomass and/or peat is reported here in synthesis tables.

5.2.3.1 Techniques to reduce diffuse/fugitive emissions to air

Information on general techniques to reduce diffuse/fugitive emissions to air is given in Section 2.8. Table 5.42 gives additional information specific to biomass and peat firing, e.g. on environmental performances and example plants.

Table 5.42: Techniques to reduce diffuse/fugitive emissions to air

Technique	Technical description	Achieved environmental benefits	Environmental performance and operational data	Cross-media effects	Technical considerations relevant to applicability	Example plants
Unloading, transport and handling of biomass and peat						
Enclosed transfers	Closed transfer systems with bag filters	Reduction of fugitive dust emissions	High operational experience	None	Generally applicable	NA
Wind shields	Open conveyors with wind shields				Open conveyor belts can only be considered for lumpy material (wood pieces)	
Enclosed unloading	Unloading of biomass and peat in enclosed buildings equipped with a bag filter for dust abatement				Generally applicable	Plant 108-1
Cleaning devices	Cleaning devices for conveyor belts				NA	
Storage of biomass, peat and additives						
Enclosed storage	Storage of fine dusty fuel material in enclosed areas or silos	Reduction of fine particulates diffuse emissions	High operational experience	None	Generally applicable	NA
	Enclosed storage of lime/limestone in silos with dust abatement					
Wind shields	Wind shields for open storage of lumpy wood, etc.	Reduction of fugitive dust emissions				
NB: NA: No relevant specific information available.						

5.2.3.2 Techniques to improve the general environmental performance

Information on general techniques to improve the general environmental performance is given in Section 3.1.1. Table 5.43 gives additional information specific to biomass and peat firing, e.g. on environmental performances and example plants.

Table 5.43: Techniques to improve the general environmental performance

Technique	Technical description	Achieved environmental benefits	Environmental performance and operational data	Cross-media effects	Technical considerations relevant to applicability		Example plants
					New plants	Existing plants	
Separate classifying and storage of biomass fuels of different sizes and qualities	Management of co-fired fuels and arranging for fuel blends that favour the limitation of CO and other pollutants' peaks	Stable combustion conditions	High operational experience	NA	Applicable to biomass-fired plants		Plant 108-1
Fuel choice	The choice of an appropriate mixture of biomasses and peat can help in controlling the environmental performances of the plant - see also Section 3.1.1.4	Lower emission levels of SO _x , HF, HCl, etc. Lower specific fuel consumption			May be constrained by the availability of different types of fuel with a better environmental profile as a whole, which may be impacted by the energy policy of the Member States. For existing combustion plants, the type of fuel chosen may be limited by the configuration and the design of the plant	NA	
Fuel specification in supplier contract	The fuel supplier adheres to the moisture (and size) specifications in the contract	Stable combustion conditions. Lower NO _x and CO emissions		Generally applicable			
Advanced control system	See Section 3.2.3.8	Complete combustion, Low NO _x and CO emissions		None	Generally applicable	The applicability to old combustion plants may be constrained by the need to retrofit the combustion and/or control command system(s)	Plant 42
NB: NA: No relevant specific information available.							

5.2.3.3 Techniques to increase energy efficiency

Information on general techniques to increase energy efficiency is given in Section 3.2.3. Table 5.44 gives additional information specific to biomass and peat firing, e.g. on example plants.

Figure 5.44 shows the operating electrical efficiencies and total fuel utilisation of some European biomass- and/or peat-fired combustion plants, commissioned between 1968 and 2011, operated between 1 700 h/yr and 8 700 h/yr, with an equivalent full load factor above 20 %.

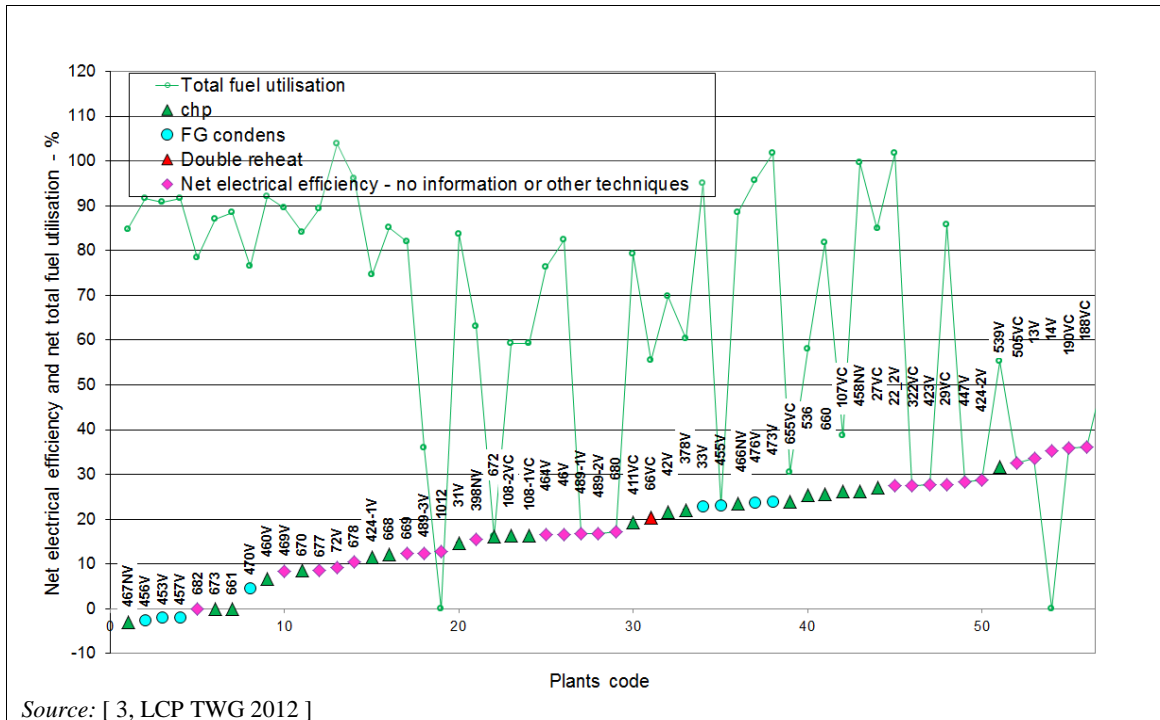

Figure 5.44: Operating energy efficiencies of European biomass- and/or peat-fired combustion plants

The net design total fuel utilisation levels of seven CHP combustion plants were reported by the [66, TWG Task Force on Energy Efficiency 2014]. Plant 411 reported a value of 73 % and Plant 33 reported a value of 99 %. The net design electrical efficiencies reported by Plant 190 and Plant 536 are 38 % and 33.7 % respectively.

Compared to bigger plants, which may use a high proportion of peat or wood pellets, smaller plants (e.g. < 150 MW_{th}) may use a higher share of wet biomass fuels, which is also the case in newer plants. [91, AET 2015]

Table 5.44: Techniques to increase energy efficiency

Technique	Technical description	Achieved environmental benefits	Environmental performance and operational data	Cross-media effects	Technical considerations relevant to applicability		Economics	Example plants	
					New	Existing			
Heat recovery in CHP plants	Biomass and/or peat are used in combined heat and power production, due to the high fuel efficiency compared to the electrical efficiency - see Section 3.2.3.2	Increased total fuel utilisation	High operational experience	None	Applicable within the constraints associated with the local power and heat demand		NA	Plants 539, 660	
Change of turbine blades	Steam turbine blades can be changed to three-dimensional blades during regular maintenance intervals - see Section 3.2.3.13	Increased efficiency	High operational experience		The applicability may be restricted by demand/steam conditions and/or limited plant lifetime			NA	NA
Feed-water preheating using recovered heat	A regenerative feed-water heating retrofit is also possible in special cases - see Section 3.2.3.7		NS		Generally applicable	Very limited			
Reheat cycle	See Section 2.2		There is experience in plants of ≥ 20 MWe	Generally applicable	Not applicable				
Economiser/flue-gas cooler	This effectively reduces the boiler (and stack) exit temperature of the flue-gas, increasing the boiler efficiency - see also Section 3.2.3.1		NA	NA	Generally applicable	Limited			
Heat recovery from grate cooling	Instead of dumping the heat from the grate cooling as a loss, it is kept in the cycle (the grate is part of the evaporator)	Additional cost for the heat exchanger							
Heat recovery from fluidised bed	Instead of dumping the heat from the fluidised bed as a loss, it is kept in the cycle with a specific heat exchanger - see also Section 3.2.3.1								
Flue-gas condenser	Additional heat recovery due to flue-gas condensation - see also Section 3.2.3.150	Increased efficiency / reduced emissions	High operational experience	Waste water stream generated (condenser blowdown)	Applicable to CHP units provided there is enough demand for low-temperature heat	NA	Plant 476		

Fuel drying	<p>With steam or flue-gas, low value heat can be recovered from power processes to increase the fuel energy (e.g. by recovering the heat from the flue-gas). Many alternative technologies are commercially available. New technical alternatives are under development.</p> <p>With press drying, electricity is used to reduce the moisture. See also Section 3.2.3.18</p>	<p>Increased combustion efficiency, expansion for potential biomass fuels, safer use.</p> <p>Many benefits are achieved if fuel can be dried just before combustion.</p>	<p>Steam dryers are most efficient.</p> <p>The implementation of drying systems can save 10 % of fuel consumption with wet fuels like peat or wood.</p> <p>Over-drying is avoided; moisture content of the raw biomass is reduced to 40–60 %. Moisture has a cooling role in the boiler and affects ESP efficiency, etc.</p>	<p>Additional emissions to water and air: e.g. bark pressing may generate high BOD releases to water and high energy use and maintenance.</p> <p>Moisture content in biomass-promoted biological activity and may increase the tendency to self-ignition</p>	<p>Applicable to the combustion of biomass and/or peat, or to the combustion of lignite within the constraints associated with spontaneous combustion risks (e.g. the moisture content of peat is kept above 40 % throughout the delivery chain).</p> <p>The retrofit of existing plants may be restricted by the extra calorific value that can be obtained from the drying operation and by the limited retrofit possibilities offered by some boiler designs or plant configurations</p>	Additional cost of dryers	NA
Biomass gasification	Gasification constitutes a viable alternative to normal combustion. See Chapter 4	<p>Increased plant efficiency and lower emission levels.</p> <p>Gas can be used as a reburning fuel to reduce emissions of NO_x</p>	Expected electrical efficiencies of 51–55 %	NA	To date only applied in demonstration and pilot plants	Expensive in small scale, limited experience	Vaskiluoto Power Plant
<p>NB: NA: No relevant specific information available. Source: [3, LCP TWG 2012] [43, EPPSA 2012]</p>							

5.2.3.4 Techniques to prevent and/or control NO_x, N₂O and CO emissions

Information on general techniques, including information on combustion optimisation, for the prevention and control of NO_x, N₂O and CO emissions is given in Section 3.2.2.3. Table 5.45 gives information specific to biomass and/or peat firing, e.g. on environmental performances and example plants. Further details on related environmental performance and operational data are provided after the table.

Table 5.45: Techniques for the prevention and control of NO_x, CO and N₂O emissions

Technique	Technical description	Achieved environmental benefits	Environmental performance and operational data	Cross-media effects	Technical considerations relevant to applicability		Economics	Example plants
					New plants	Existing plants		
Primary techniques								
Low excess air	See Section 3.2.2.3.1	Reduction of NO _x , CO, HC and N ₂ O emissions, increased efficiency	See Figure 5.45, Figure 5.46 and Figure 5.47. Levels of N ₂ O are in the range of 0.4–13 mg/Nm ³ . High operational experience	Reduction of NO _x emissions may lead to higher unburnt carbon-in-ash	Generally applicable	Plant-specific	NA	
Fuel staging	See Section 3.2.2.3.6	Reduction of NO _x		NA			Plant 1012	
Air staging	See Section 3.2.2.3.2	Reduction of NO _x and N ₂ O		May lead to higher unburnt carbon-in-ash in case of wrong furnace design			Plant 669	
Flue-gas recirculation	See Section 3.2.2.3.3	Reduction of NO _x and N ₂ O		NA			Plant 456	
Low-NO _x burners (LNBS)	See Section 3.2.2.3.5. Low-NO _x burners for pulverised biomass firing have been developed and implemented	Reduction of NO _x		May lead to higher unburnt carbon-in-ash in cases of wrong furnace design			Plant 27	
Secondary techniques								
Selective non-catalytic reduction (SNCR)	See Section 3.2.2.3.12. Can be applied in combination with a 'slip' catalyst. Small grate boilers (e.g. 40–120 MW, firing straw or biomass together with peat for cogeneration) can be fitted with SNCR	Reduction of NO _x	See Figure 5.45, Figure 5.46 and Figure 5.47. High operational experience.	Ammonia slip and ammonia sulphate salts formation. Ash 'ammonification'	Sensitivity to highly variable boiler loads that can be reduced by implementing several levels of reagent injection	There may be constraints due to the temperature window and the residence time to be reached by the reactants' injection. Sensibility to highly variable boiler loads that can be reduced by implementing several levels of reagent injection.	Plant-specific	Plants 670, 476, 42

Selective catalytic reduction (SCR)	See Section 3.2.2.3.11. Small grate boilers (e.g. 40–120 MW, firing straw or biomass together with peat for cogeneration) can be fitted with low-dust SCR. SCR catalyst deactivation due to poisoning is manageable. High-dust SCR may not be suitable for straw-firing combustion plants, due to catalyst deactivation by the fly ash	Reduction of NO _x	See Figure 5.45, Figure 5.46 and Figure 5.47.	Catalysts may be deactivated at low temperatures due to the alkali content of the fuel. Minor ammonia slip	Generally applicable	There may be economic restrictions for retrofitting combustion plants of < 300 MW _{th} . Not generally applicable to combustion plants of < 100 MW _{th}	Plant-specific. Not viable for combustion plants operated < 500 h/yr	Plants 31, 14
NB: NA: No relevant specific information available.								

The large majority of well-performing plants shown in Figure 5.45, Figure 5.46, and Figure 5.47 continuously monitor NO_x emission concentrations and average short-term values (daily, hourly or half-hourly basis); some plants monitor periodically. No evidence of correlation between the plotted emission concentrations and plant age (commissioning years between 1963 and 2011), load (equivalent full load factor above 38 %) or operating hours (total operating hours per year ranging between 1 700 and 8 700) is observed. [3, LCP TWG 2012]

Figure 5.45 shows NO_x, CO and NH₃ emissions from well-performing plants of < 100 MW_{th}. The TWG considered in the Final Meeting that NO_x emissions in the case of plants burning high-alkali fuels may be slightly higher (i.e. up to 250 mg/Nm³).

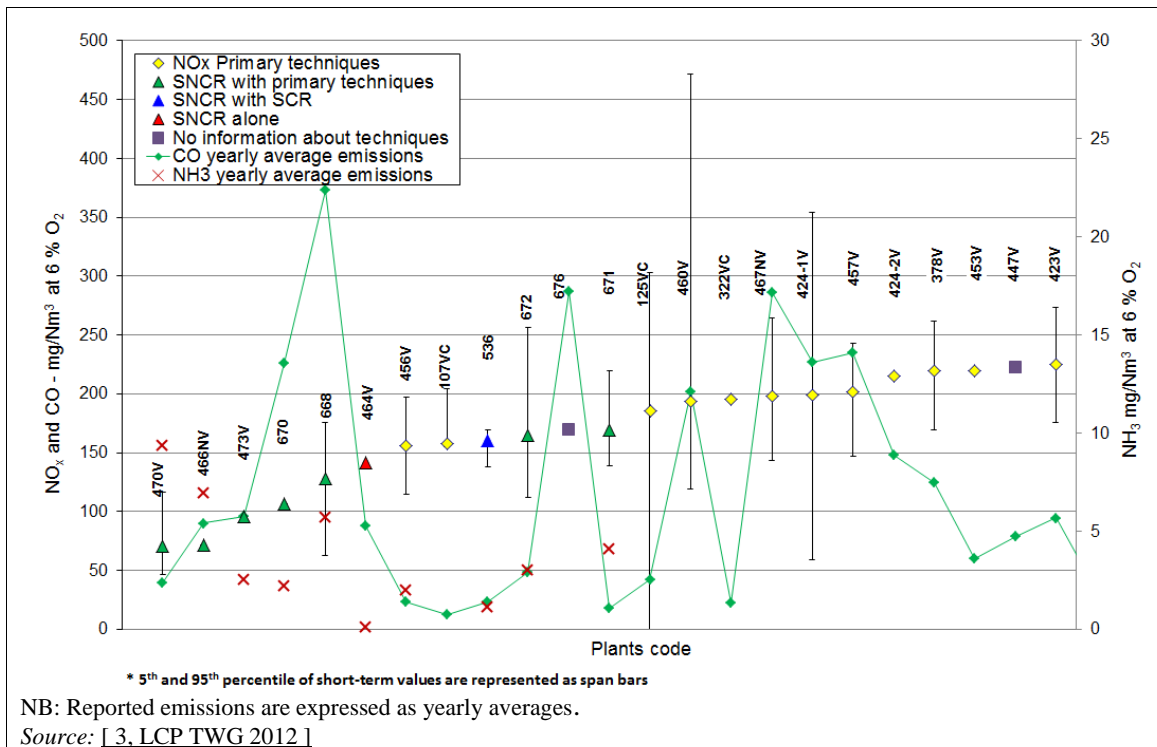

Figure 5.45: NO_x emissions from well-performing biomass- and/or peat-fired plants of < 100 MW_{th}

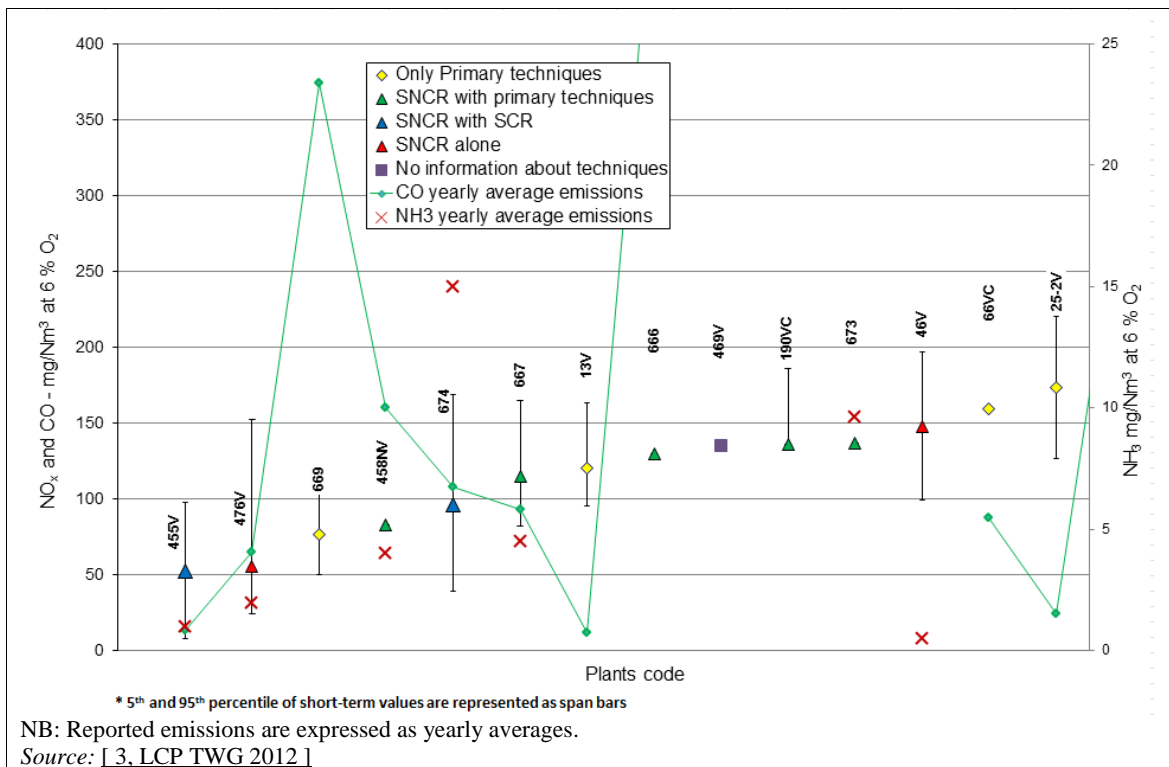

Figure 5.46: NO_x emissions from well-performing biomass- and/or peat-fired plants between 100 MW_{th} and 300 MW_{th}

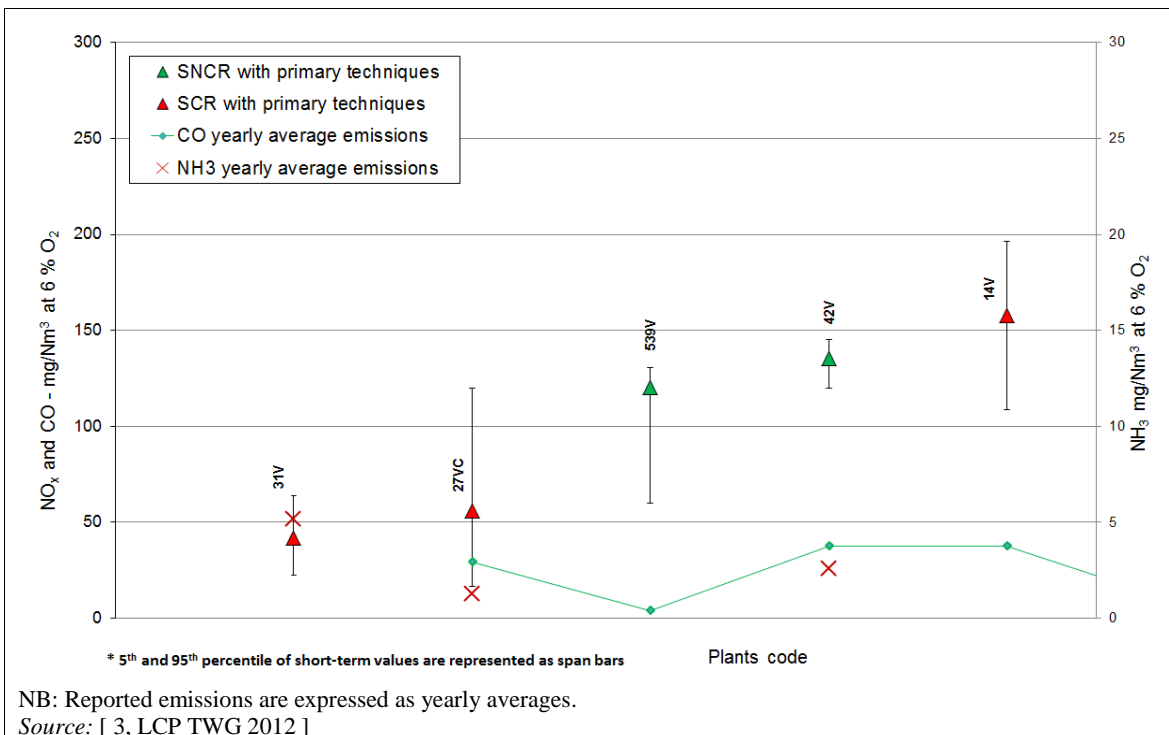

Figure 5.47: NO_x emissions from well-performing biomass- and/or peat-fired plants of ≥ 300 MW_{th}

5.2.3.5 Techniques to prevent and/or control SO_x, HCl and HF emissions

Information on general techniques for the prevention and control of SO_x, HCl and HF emissions is given in Section 3.2.2.2. Table 5.46 gives additional information specific to biomass and/or peat firing, e.g. on environmental performances and example plants. Further details on related environmental performance and operational data are provided after the table.

Table 5.46: Techniques for the prevention and control of SO_x, HCl and HF emissions

Technique	Technical description	Achieved environmental benefits	Environmental performance and operational data	Cross-media effects	Technical considerations relevant to applicability		Economics	Example plants
					New plants	Existing plants		
Fuel choice	In the co-combustion of biomass, the biomass alkali content increases the SO _x capture. Peat sands keep the boiler clean. See also Section 3.1.1.4	Reduction of SO _x and HCl emissions at source	High operational experience	NA		There may be constraints associated with the availability of different types of fuel, which may be impacted by the energy policy of the Member State	Depends on type of fuel	Plant 322
Boiler sorbent injection	Furnace injection. The sorbent injected is usually limestone. The desulphurisation does not increase over about 45 % in the BFB boiler, even with much higher Ca/S ratios. In CFBC, the highest achievable degree of desulphurisation is around 80 %, but that could only be reached with a very high Ca/S ratio. See also Sections 2.2 and 3.2.2.2.10	Reduction of SO _x and NO _x emissions	The degree of desulphurisation in peat-fired FBC boilers is significantly lower than in coal-fired FBC boilers. According to the knowledge gained with peat in FBC boilers, the degree of desulphurisation in peat firing with moderate Ca/S ratios (3–5) for CFBC is 50–70 % and for BFBC is around 30–40 %.	Emissions of N ₂ O Significant fouling was reported in the BFBC plant.	Generally applicable	EUR 1 300–1 400/t SO ₂ removed (SO ₂ emission: 360 mg/Nm ³). EUR 2 100–2 700/t SO ₂ removed (SO ₂ emission: 200–280 mg/Nm ³). A high Ca/S ratio implies elevated limestone feeding rates and related costs.		Plant 25-2
Spray dry scrubber or absorber (SDA)	See Section 3.2.2.2.6	Reduction of SO _x , HF, HCl, dust	SO ₂ removal efficiencies up to 92 %.	Residues that need to be landfilled	Generally applicable		NA	Plant 489-3

Duct sorbent injection (DSI)	Calcium hydroxide or sodium bicarbonate in-duct injection in dry form before the bag filter or ESP. High Ca/S ratios result in a large addition to the amount of by-product collected by ESPs. See also Section 3.2.2.2.8	Reduction of SO _x , HF and HCl	NA	The low levels of SO ₂ mean that the utilisation opportunities for the ash will be lower (high pH, Cl and metals content). The quality and quantity of the by-product is reduced	Generally applicable	NA	Plant 505	
Wet flue-gas desulphurisation (wet FGD)	Wet flue-gas desulphurisation with scrubbing. See Section 3.2.2.2.1	Reduction of SO _x , HF, HCl and dust	SO ₂ removal efficiency up to or higher than 99 %.	NA	Generally applicable	There may be technical and economic restrictions for retrofitting combustion plants operated between 500 h/yr and 1 500 h/yr.	Not viable to combustion plants operated < 500 h/yr	Plants 27, 31
Flue-gas condenser	See Section 3.2.3.15	Reduction of SO _x	NA	NA	Generally applicable	NA	Plants 455, 457	
Wet scrubbing	See Section 3.2.2.6.2	Acid gas reduction	NA	NA	Generally applicable		Plant 672	
CFB scrubber	See Section 3.2.2.2.7	Reduction of SO _x and halide emissions. Improvement of dust removal efficiency	SO _x removal efficiency: 90–99 %. Halide reduction efficiency: > 95 %	By-product marketability may be an issue	Generally applicable		NA	
NB: NA: No relevant specific information available.								

Several well-performing plants shown in Figure 5.48, Figure 5.49 and Figure 5.50 continuously monitor SO_2 emission concentrations and average short-term values (daily, hourly or half-hourly basis); some plants monitor these emissions periodically. No evidence of correlation between the plotted emission concentrations and plant age (commissioning years between 1963 and 2011), load (equivalent full load factor above 38 %) or operating hours per year (total operating hours ranging between 2 800 and 8 700) is observed. [3, LCP TWG 2012] [44, Lecomte and Jankov 2012]

Dry, semi-dry and wet abatement techniques are applied and available for the three categories of biomass-firing plants, showing in general lower SO_x emissions compared to coal-fired plants. Considering that wet abatement techniques may be fitted not only for SO_x abatement but also for other pollutants (e.g. HCl) or for other purposes (i.e. flue-gas condenser) and the level of SO_x in the flue-gas may not be very high, the reported SO_x emissions are generally low. In addition to Figure 5.48, Plant 190, reporting yearly average SO_2 emissions of 100 mg/Nm^3 (short emissions concentration of 215 mg/Nm^3), combusts 100 % peat (sulphur content $> 0.1 \text{ wt-\%}$), uses the boiler sorbent injection technique, and is considered a representative example for smaller plants or plants using a higher sulphur content in the fuel. The use of the duct sorbent injection technique in bigger plants allows achieving emissions below 70 mg/Nm^3 (e.g. Plant 46), and, with the use of SDA in plants $\geq 300 \text{ MW}_{\text{th}}$, SO_2 emissions may be less than 50 mg/Nm^3 (e.g. Plant 489-3 is a smaller plant fitted with SDA that reports 50 mg/Nm^3).

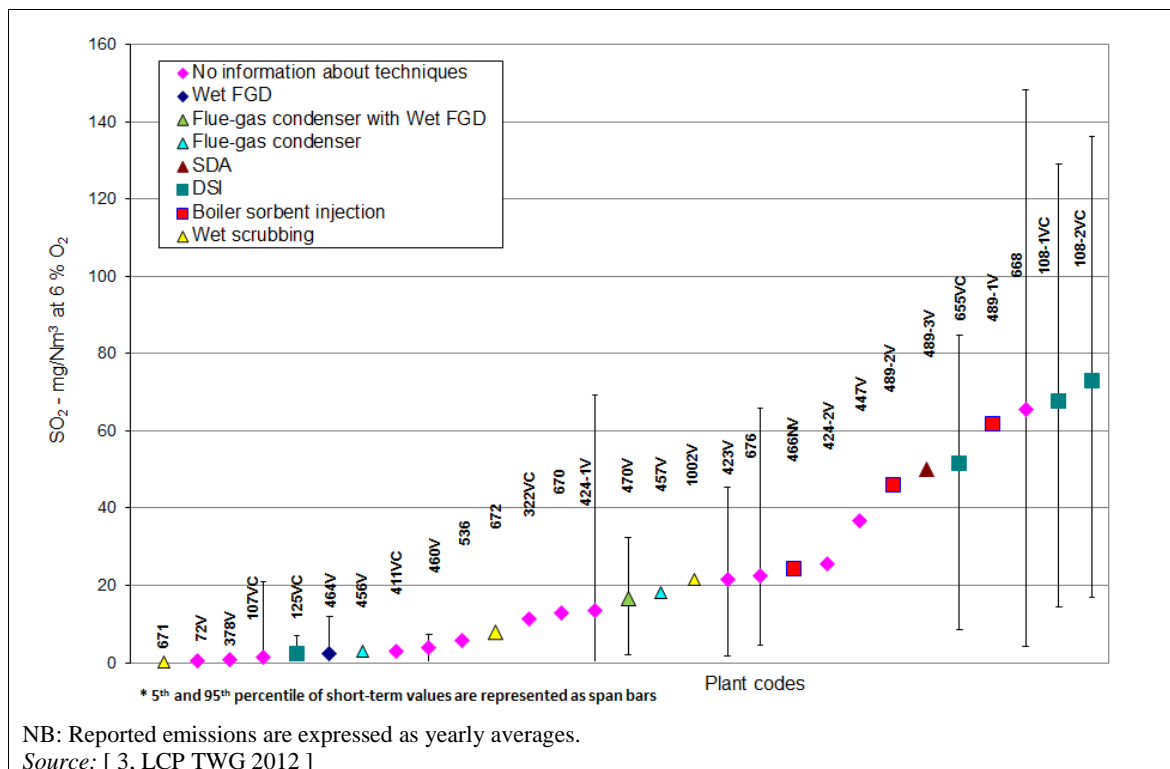

Figure 5.48: SO_2 emissions from well-performing biomass- and/or peat-fired plants of $< 100 \text{ MW}_{\text{th}}$

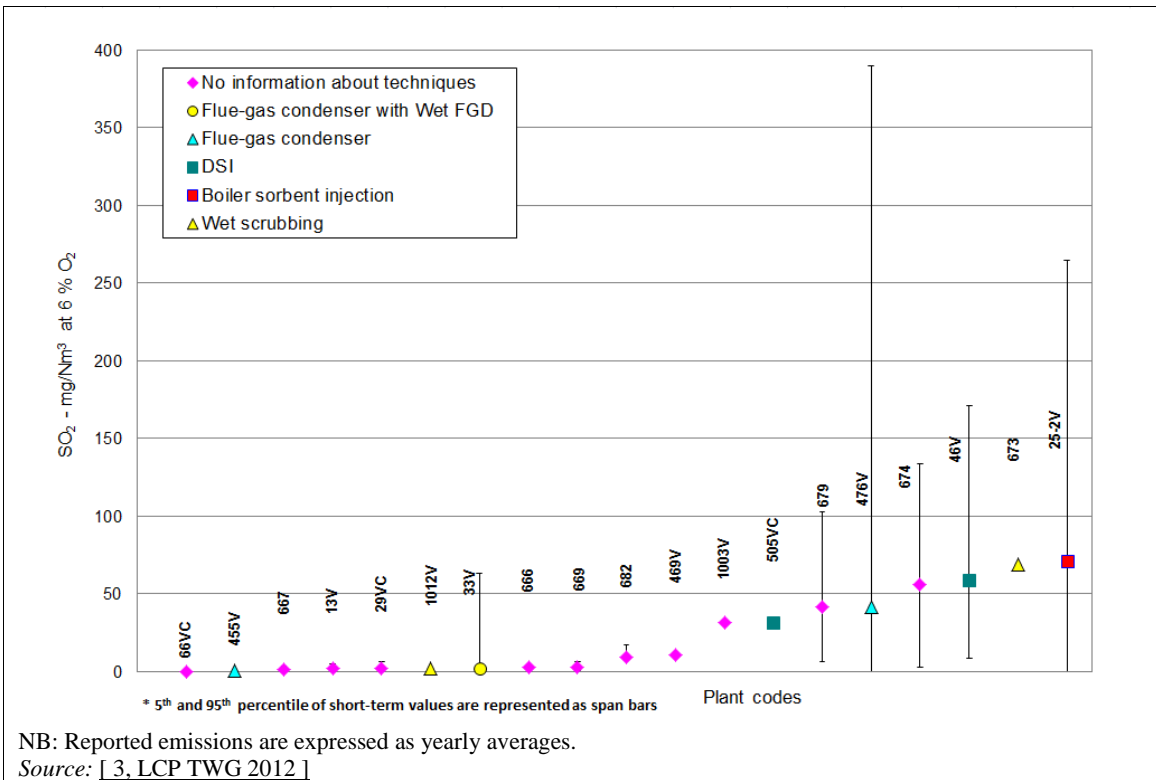

Figure 5.49: SO₂ emissions from well-performing biomass- and/or peat-fired plants between $\geq 100 \text{ MW}_{\text{th}}$ and $< 300 \text{ MW}_{\text{th}}$

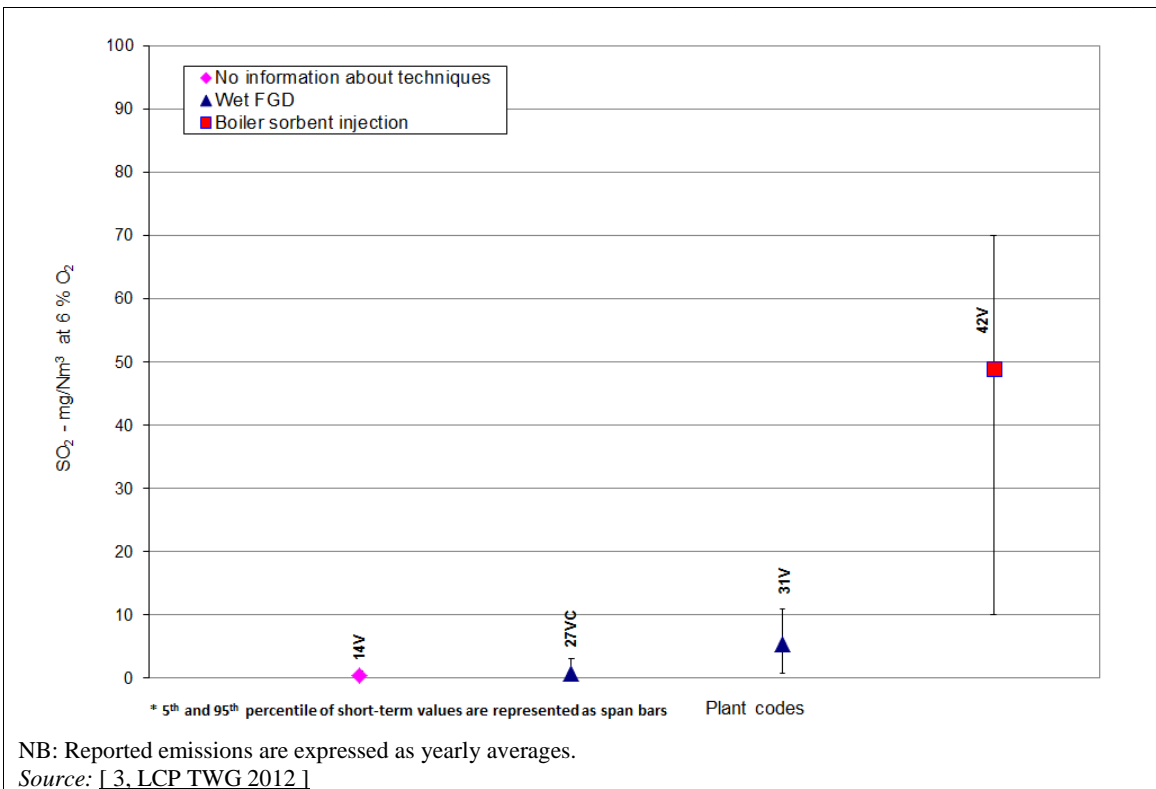

Figure 5.50: SO₂ emissions from well-performing biomass- and/or peat-fired plants of $\geq 300 \text{ MW}_{\text{th}}$

Several plants shown in Figure 5.51 and Figure 5.52 continuously monitor HCl emission concentrations and average short-term values (hourly, daily or half-hourly basis); some plants monitor these emissions periodically.

As mentioned before, dry, semi-dry and wet abatement techniques proposed as BAT may be applied and are available for the three categories of biomass-firing plants. Wet abatement techniques may be fitted not only for HCl emissions abatement but also for other pollutants (i.e. SO_x) and/or for other purposes (i.e. flue-gas condenser). HCl emissions depend on the Cl content of the fuel (e.g. Plant 505V, equipped with the duct sorbent injection technique, burns a Cl content in the biomass close to 0.1 wt-% and reported yearly average HCl emissions of 15 mg/Nm^3 ; and Plant 33, fitted with wet abatement techniques, burns 100 % straw with more than 0.1 wt-% Cl and reported yearly average HCl emissions below 25 mg/Nm^3). Emissions may depend on the fuel mix but also on other factors (e.g. the use of sulphur-rich compounds to avoid negative effects due to the alkalinity of certain fuels).

The plants of $< 100 \text{ MW}_{\text{th}}$ represented in Figure 5.51 reported emissions below those reported by Plant 505V, a $139 \text{ MW}_{\text{th}}$ plant fitted with duct sorbent injection (i.e. 15 mg/Nm^3).

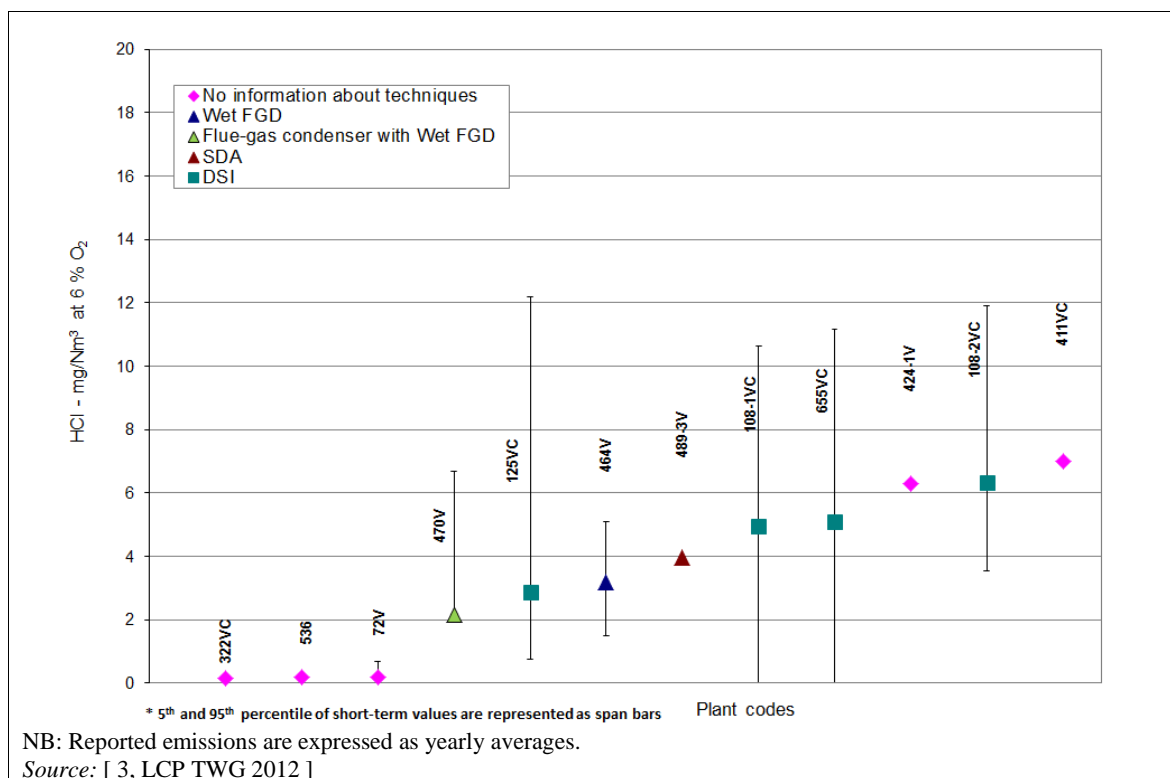

Figure 5.51: HCl emissions from well-performing biomass- and/or peat-fired plants of $< 100 \text{ MW}_{\text{th}}$

Almost all the plants of $\geq 100 \text{ MW}_{\text{th}}$ and $< 300 \text{ MW}_{\text{th}}$ burning only woody biomass reported HCl emissions below 9 mg/Nm^3 , e.g. Plant 25-2 using boiler sorbent injection. Well-performing plants are represented in Figure 5.52.

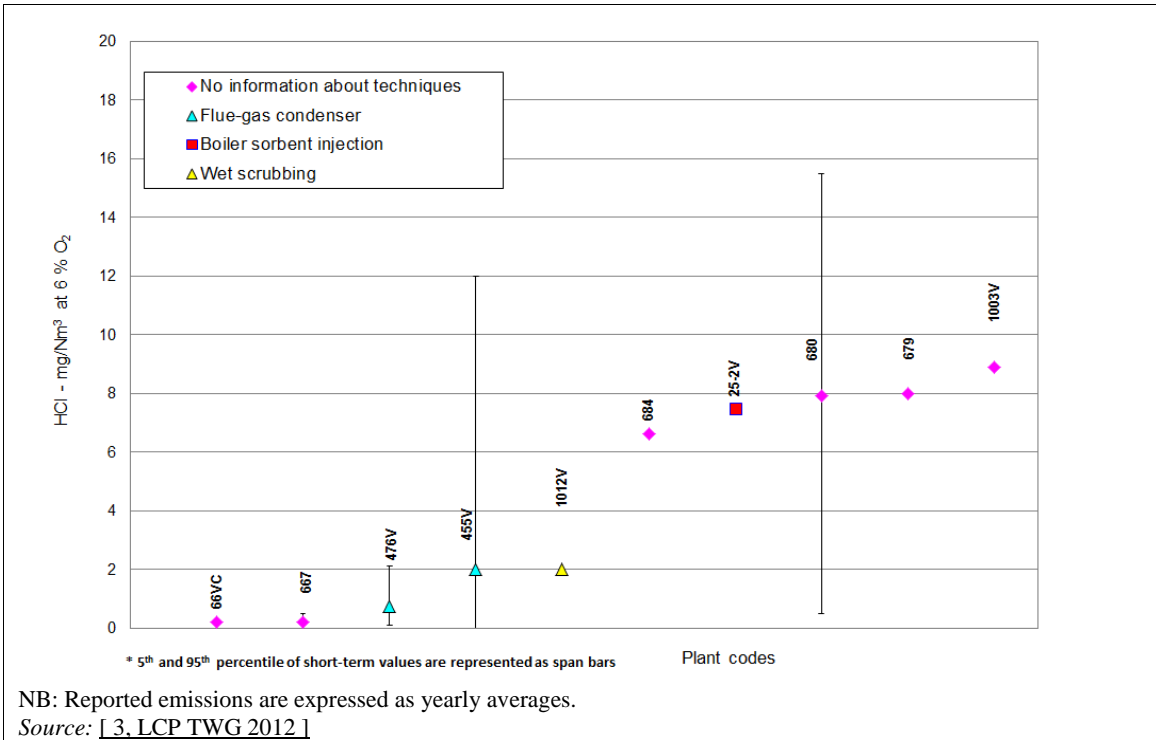

Figure 5.52: HCl emissions from well-performing biomass- and/or peat-fired plants between $\geq 100 \text{ MW}_{\text{th}}$ and $< 300 \text{ MW}_{\text{th}}$

In the case of plants of $\geq 300 \text{ MW}_{\text{th}}$, Plant 31 and Plant 42 report HCl emissions below 5 mg/Nm^3 , which is the emission level reported by Plant 489-3 using SDA. [3, LCP TWG 2012]

Most of the well-performing plants shown in Figure 5.53 and Figure 5.54 periodically monitor HF emission concentrations (short-term spot measurement); four plants monitor these emissions continuously.

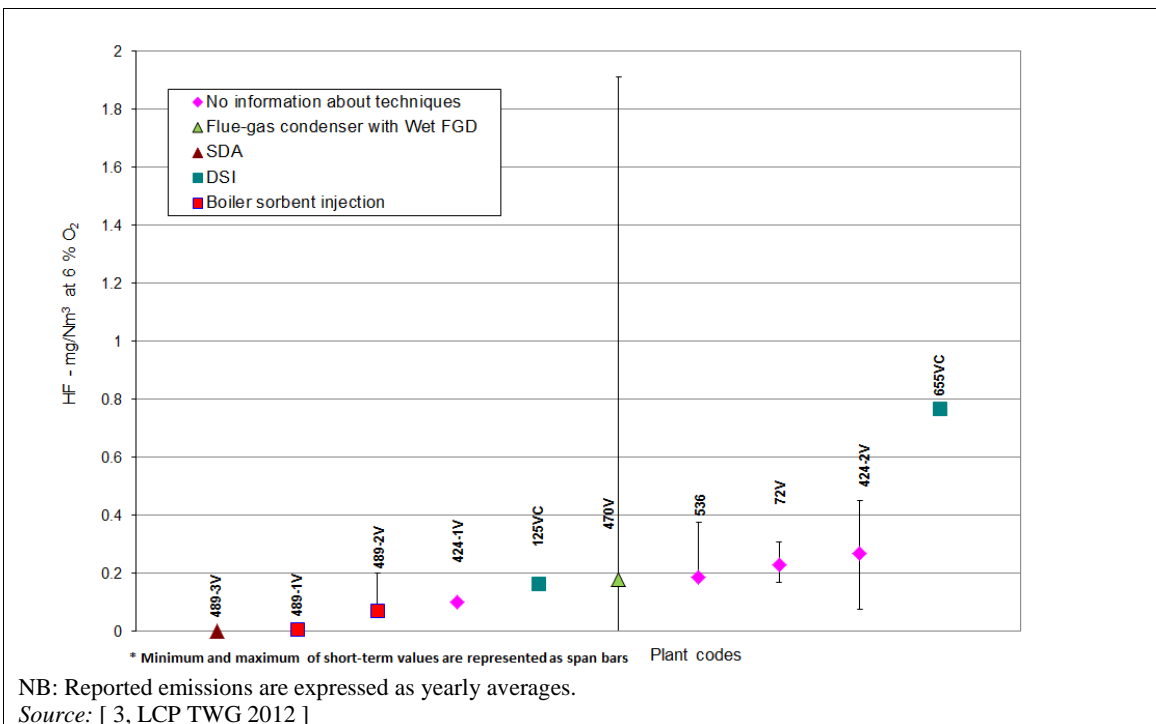

Figure 5.53: HF emissions from well-performing biomass- and/or peat-fired plants of $< 100 \text{ MW}_{\text{th}}$

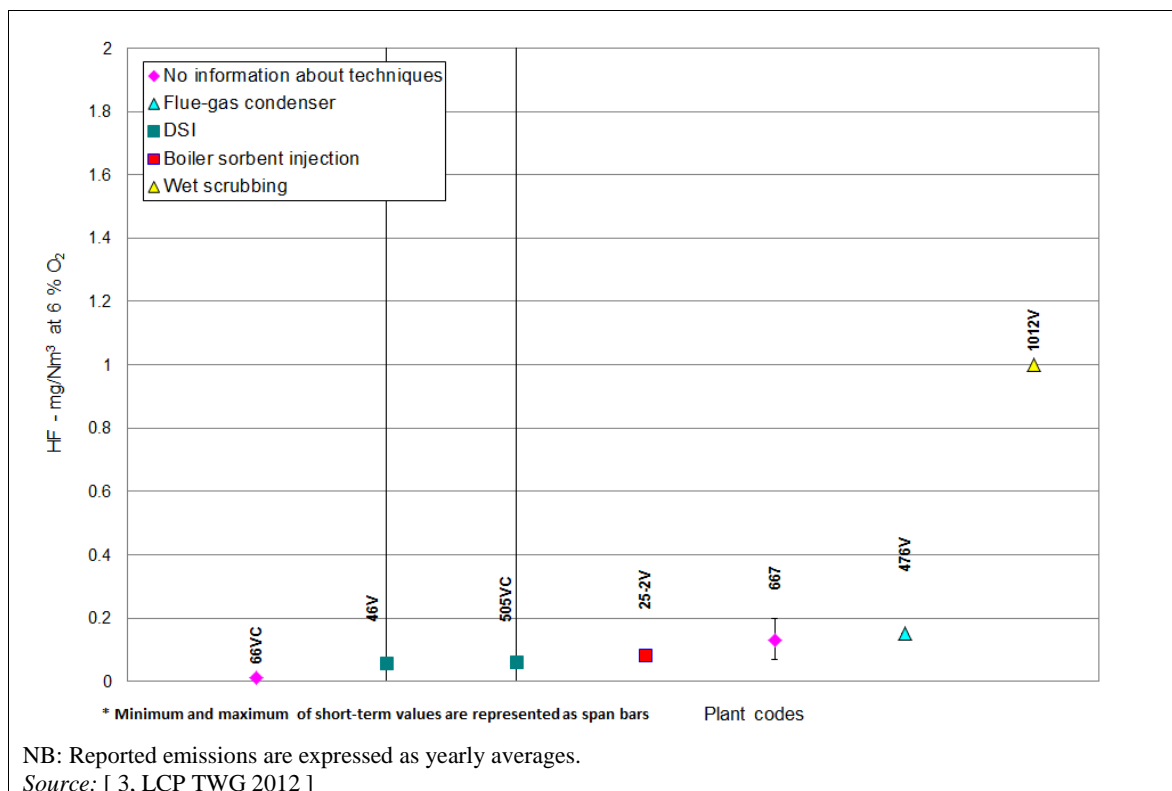

Figure 5.54: HF emissions from well-performing biomass- and/or peat-fired plants between $\geq 100 \text{ MW}_{\text{th}}$ and $< 300 \text{ MW}_{\text{th}}$

In the case of plants of $\geq 300 \text{ MW}_{\text{th}}$, Plant 31 and Plant 1004 report HF emissions below 1 mg/Nm^3 . [3, LCP TWG 2012]

5.2.3.6 Techniques to prevent and/or control dust and particulate-bound metal emissions

Information on general techniques for the prevention and control of dust and particulate-bound metals emissions is given in Section 3.2.2.1. Table 5.47 gives additional information specific to biomass and/or peat firing, e.g. on environmental performances and example plants. Further details on related environmental performance and operational data are provided after the table.

Table 5.47: Techniques for the prevention and control of dust and metal emissions

Technique	Technical description	Achieved environmental benefits	Environmental performance and operational data	Cross-media effects	Technical considerations relevant to applicability	Economics	Example plants
Fuel choice	By switching to a different fuel or by modulating the fuel blend (e.g. fuel with lower ash content), the corresponding emissions are reduced. See also Section 3.1.1.4	Reduction of particulate emissions	NA	NA	Applicable within the constraints associated with the availability of different types of fuel, which may be impacted by the energy policy of the Member State	NA	NA
Bag filter	See Section 3.2.2.1.2	Reduction of particulate emissions, including fine dust (PM _{2.5} and PM ₁₀) and particulate-bound heavy metals	High operational experience	Fire risk. Where the ash has a high amount of unburnt matter, a pre-collector upstream of the bag filter may reduce the risk of hopper fires and bag damage	Generally applicable	The investment cost for a new bag filter is less than that for an ESP, but operating costs are higher	Plants 72, 667
Electrostatic precipitator (ESP)	See Section 3.2.2.1.1	Reduction of particulate emissions and particulate-bound heavy metals		None		NA	Plants 424-2, 29
Desulphurisation techniques	See Section 3.2.2.2 These techniques are mainly used for SO _x , HCl or HF control	SO _x and halide reduction with additional reduction effect on dust emissions	NA	NA	See Table 5.46	NA	Plants 672, 31
NB: NA: No relevant specific information available.							

Several well-performing plants shown in Figure 5.55, Figure 5.56 and Figure 5.57 continuously monitor dust emission concentrations and average short-term values (daily, hourly or half-hourly basis); some plants monitor these emissions periodically. No evidence of correlation between the plotted emission concentrations and plant age (commissioning years between 1963 and 2011), load (equivalent full load factor above 50 %) or operating hours per year (total operating hours ranging between 3 200 and 8 600) is observed. [3, LCP TWG 2012]

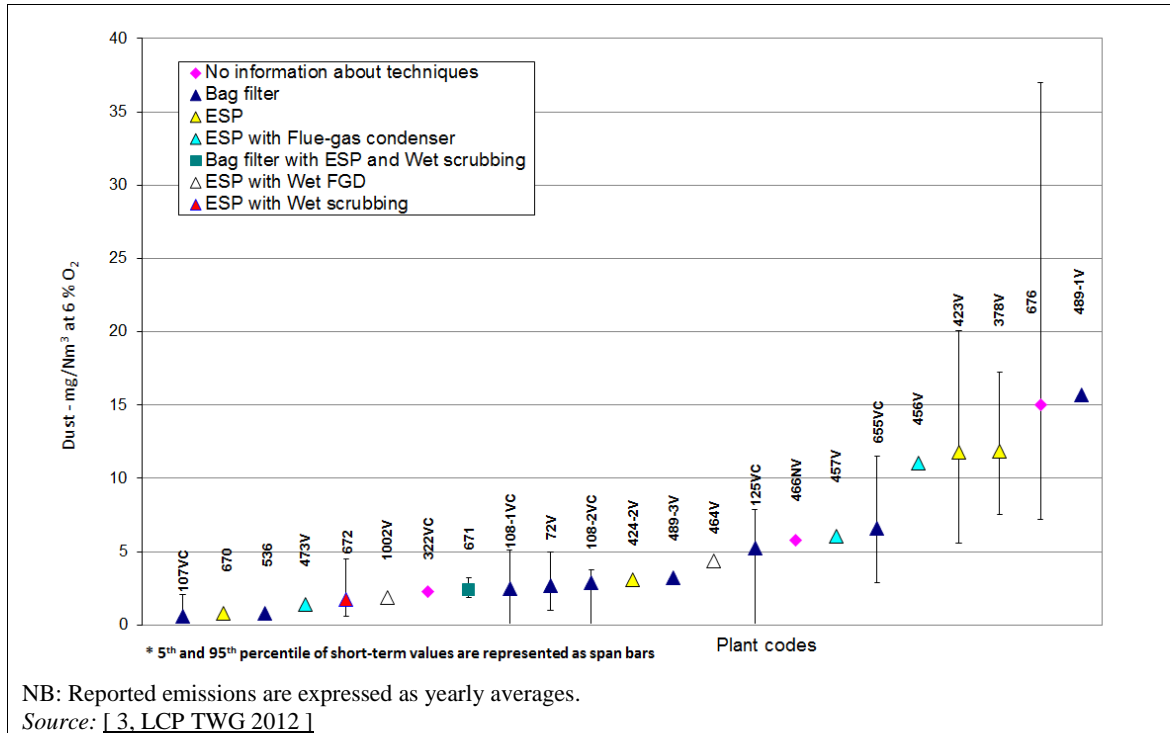

Figure 5.55: Dust emissions from well-performing biomass- and/or peat-fired plants of < 100 MW_{th}

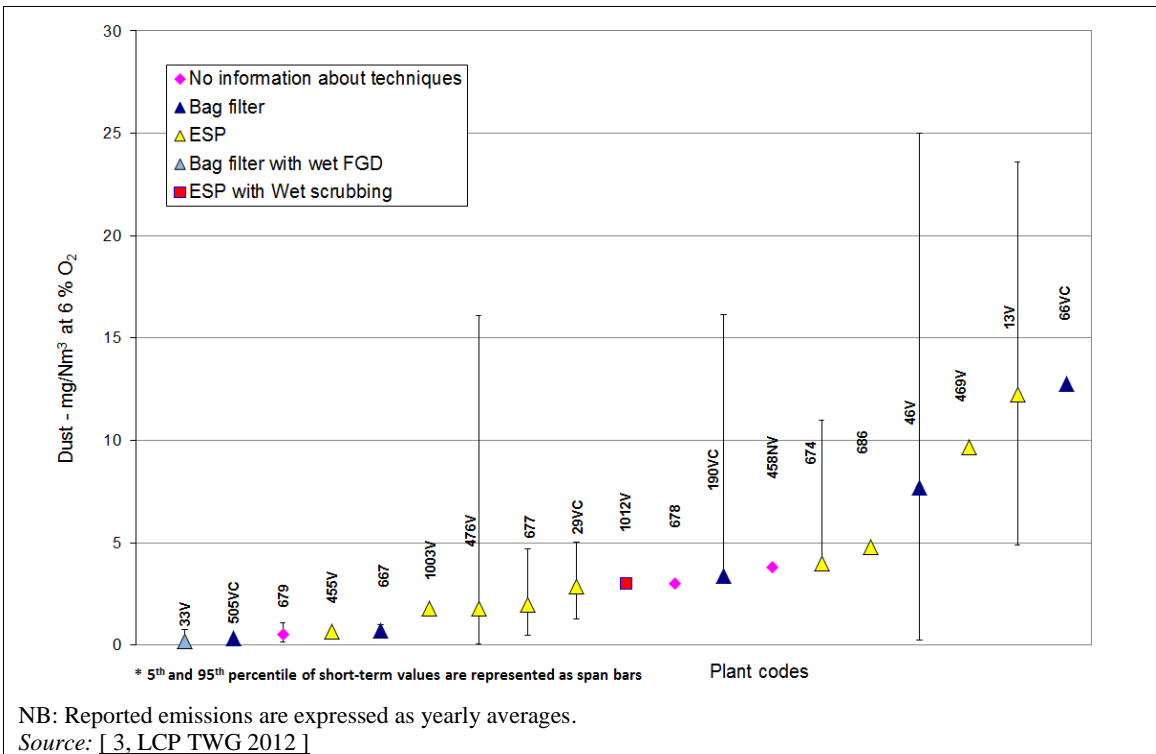

Figure 5.56: Dust emissions from well-performing biomass- and/or peat-fired plants between 100 MW_{th} and 300 MW_{th}

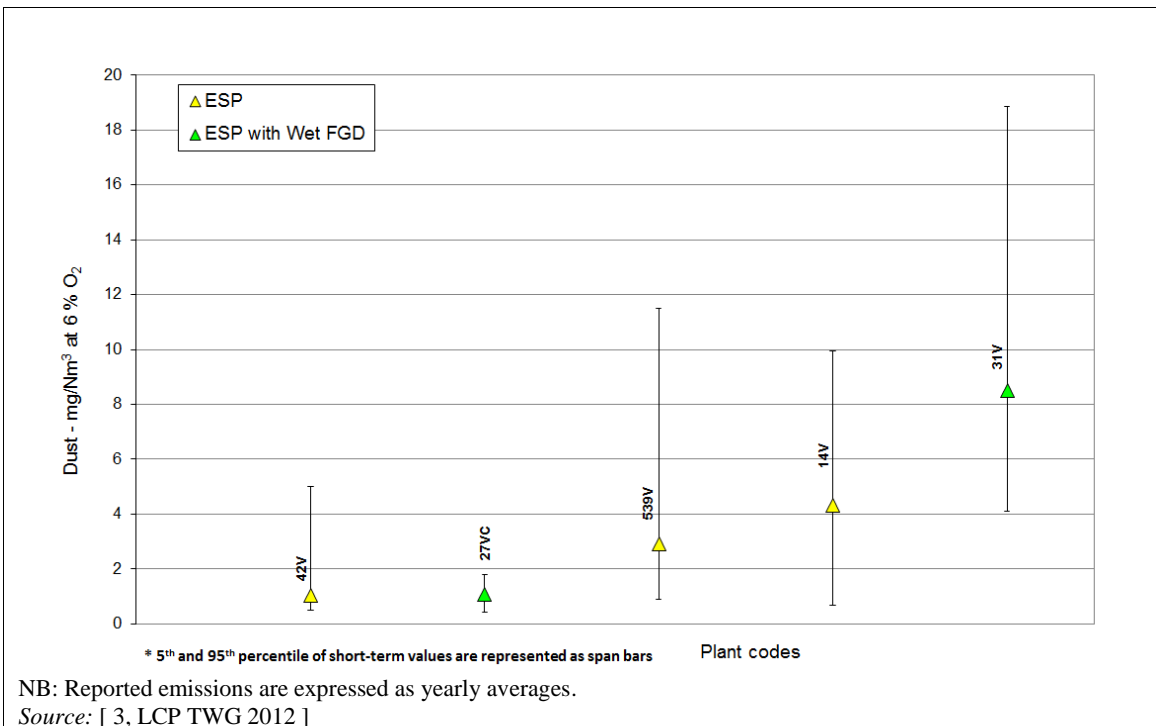

Figure 5.57: Dust emissions from well-performing biomass- and/or peat-fired plants of ≥ 300 MW_{th}

5.2.3.7 Techniques to prevent and/or control mercury emissions

Information on general techniques for the prevention and control of mercury emissions is given in Section 3.2.2.5. Table 5.48 presents the techniques or combination of techniques commonly used in combustion plants, and Figure 5.58 gives information specific to biomass and/or peat firing, e.g. on environmental performances and example plants. Further details on related environmental performance and operational data are provided after the table.

Table 5.48: Techniques for the prevention and control of mercury

Technique	Technical description	Achieved environmental benefits	Environmental performance and operational data	Cross-media effects	Technical considerations relevant to applicability	Example plants
Specific techniques to reduce mercury emissions						
Activated (halogenated) carbon injection	Activated carbon is injected upstream of a bag filter. The adsorption occurs both in-duct and on the filter cake. See also Section 3.2.2.5 and Section 5.1.3.4.3.2	Reduction of mercury	NA	NA	Generally applicable	Plants 125, 655
Use of halogenated additives in the fuel or injected in the furnace	See Section 3.2.2.5 and Section 5.1.3.4.3.3				Only applicable in the case of a low halide content in the fuel	NA
Co-benefit from techniques used to reduce emissions of other pollutants						
Fuel choice	See also Section 3.1.1.4	Reduction of mercury emissions	NA	NA	Applicable within the constraints associated with the availability of different types of fuel, which may be impacted by the energy policy of the Member State	NA
Bag filter	Co-benefit of dust emissions reduction by capture of particle-bound mercury. See Section 3.2.2.1.2. The technique is mainly used for dust control				See Table 5.47	Plant 66
Electrostatic precipitator (ESP)	Co-benefit of dust emissions reduction by capture of particle-bound mercury. See Section 3.2.2.1.1. The technique is mainly used for dust control				See Table 5.47	Plant 455

Dry, semi-dry or wet FGD system	See Section 3.2.2.5.2. The technique is mainly used for SO _x , HCl and/or HF control. Co-benefit of SO _x emissions reduction by solubilising and capturing the oxidised mercury				See Table 5.46	Plant 33
<p>NB: NA: No relevant specific information available. Source: [3, LCP TWG 2012] [43, EPPSA 2012]</p>						

In Figure 5.58, the well-performing plants periodically monitor mercury concentrations and average short-term values for sampling periods of durations between six hours and a few days. No evidence of correlation between plotted emission concentrations and load (equivalent full load factor above 38 %), plant age (commissioning years between 1972 and 2010) and operating hours per year (total operating hours ranging between 4 600 and 8 500) is observed.

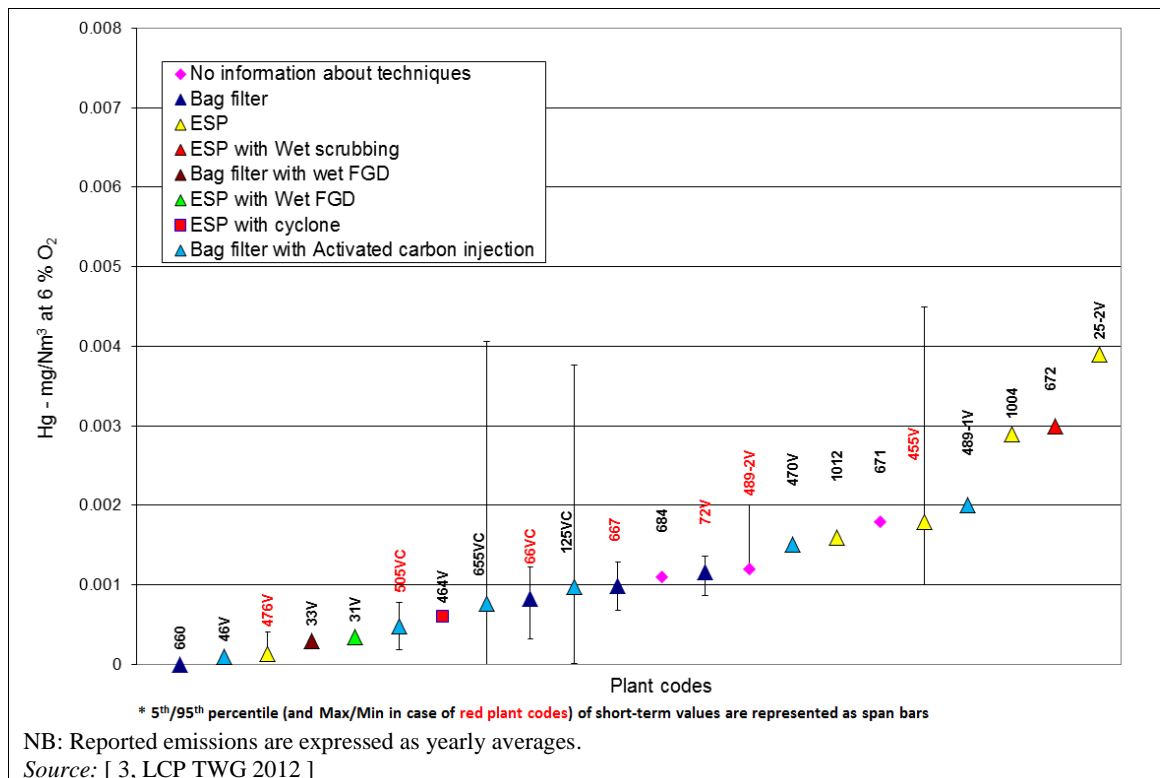

Figure 5.58: Mercury emissions from well-performing biomass- and/or peat-fired plants

5.2.3.8 Techniques to reduce and/or reuse combustion residues

The specifications of general techniques for the reduction and reuse of combustion residues are given in Section 3.2.5.

Table 5.49 gives information specific to biomass and peat firing, e.g. on environmental performances.

Table 5.49: Techniques for handling, reduction, and recycling or recovery of combustion residues

Technique	Technical description	Achieved environmental benefits	Environmental performance and operational data	Technical considerations relevant to applicability
Utilisation of biomass boiler ash	Utilisation of biomass boiler ash with low amounts of heavy metals as fertilisers	Minimisation of waste sent for disposal	It is common practice to separate the biomass ash fine fraction from coarse ash. Only coarse ash can be used as fertiliser (depending on the nutrients content and soil parameters)	Applicable within the constraints associated with the ash properties (e.g. metals content)

6 COMBUSTION OF LIQUID FUELS

6.1 Applied processes and techniques

6.1.1 Fuel characterisation

Definitions of the liquid fuels referred to in this chapter are based on the definitions given in Directive 2012/33/EU of 21 November 2012 amending Council Directive 1999/32/EC.

Therefore, gas oil is used in this document to denote any petroleum-derived liquid fuel falling within CN code 2710 19 25, 2710 19 29, 2710 19 47, 2710 19 48, 2710 20 17 or 2710 20 19. Or any petroleum-derived liquid fuel of which less than 65 vol-% (including losses) distils at 250 °C and of which at least 85 vol-% (including losses) distils at 350 °C by the ASTM D86 method.

Heavy fuel oil (HFO) is used to denote any petroleum-derived liquid fuel falling within CN code 2710 19 51 to 2710 19 68, 2710 20 31, 2710 20 35, 2710 20 39. Or any petroleum-derived liquid fuel, other than gas oil, which, by reason of its distillation limits, falls within the category of heavy oils intended for use as fuel and of which less than 65 vol-% (including losses) distils at 250 °C by the ASTM D86 method. If the distillation cannot be determined by the ASTM D86 method, the petroleum product is likewise categorised as a heavy fuel oil.

Further information about composition and properties of liquid fuels is given in Section 6.2.1.

6.1.2 Pretreatment and preparation of fuels

6.1.2.1 Pretreatment of fuels used in conventional boilers

Petroleum-derived liquid fuels, such as heavy fuel oil and gas oil, used as fuel for large combustion plants are processed in a refinery so that they comply with national and international fuel specifications. The different oil qualities used for different types of LCPs are described in Table 6.1. An important impurity in the combustion of liquid fuels is the amount of sulphur present in the fuel. Although fuel oil can be processed in the refinery to reduce the sulphur content, techniques to reduce the sulphur content of oil are not within the scope of this document and are covered in the BREF for the Refining of Mineral Oil and Gas.

6.1.2.2 Pretreatment of fuels used in diesel engines

In order to ensure correct pumping and operating conditions, diesel engines need a continuous supply of cleaned and filtered fuel oil at the correct flow and viscosity (for HFO, typically below 730 cSt at 50 °C). For heavy fuel oil, HFO treatment plants similar to those for gas turbines (see Section 6.1.3.3) are applied, but with the following differences:

- only centrifugal separators are used;
- electrical or steam coil-type heaters for heating up the HFO to the appropriate temperature are used in order to achieve the required injection viscosity, typically 12–20 cSt for a good atomisation at the nozzle;
- in normal cases, de-emulsifier dosing systems for breaking up the oil emulsion are not used, and neither are additive-dosing systems for raising the melting point of vanadium products.

When operating with gas oil, no preheating or separation of the fuel is usually needed.

6.1.2.3 Pretreatment of fuels for gas turbines

If heavy fuel oil (HFO) is to be used as a fuel in gas turbines, a special treatment procedure is required. In this case, the fuel treatment plant comprises:

- heaters, for heating the untreated HFO (electrical or steam coil type);
- de-emulsifier dosing systems, for breaking up the oil emulsion;
- separators (centrifugal or electrostatic), for removing the solid impurities in the HFO, particularly for fuels with a high ash content;
- additive-dosing systems, for raising the melting point of the vanadium oxidation products; and
- all the necessary pumps and piping equipment.

Gas oil, when used as a fuel in gas turbines, needs to be treated in order to reduce its sodium, potassium, and calcium concentrations and to remove solid impurities, which are otherwise detrimental to the turbine blades. Gas oil is treated at the fuel treatment plant, which comprises gas oil-cleaning units, either a self-cleaning centrifuge unit or an electrostatic-type unit, and all the necessary pumps and piping equipment.

6.1.3 Combustion technologies

6.1.3.1 Design of oil-fired boilers

See Section 2.2.2 for a general description of combustion in boilers.

When heavy fuel oil is combusted in boilers, a low viscosity is needed at the burner in order to ensure correct atomisation of the fuel. To obtain this viscosity, the heavy fuel oil is heated to around 120–140 °C. Additives are used to improve the combustion of heavy fuel oil.

Three major technical issues need to be taken into consideration when firing heavy fuel oil:

- the need for heated storage, transportation, and additional heating before atomisation, due to the high viscosity of the HFO;
- its tendency to form coke particulates;
- the formation of corrosive deposits.

The first two points are due to the high molecular weight and the asphaltene nature of some of the constituents. The third point stems from the presence of sulphur, nitrogen, vanadium and other metals in the fuel.

With emulsions, the physical effects of the addition of water lead to better combustion properties by improving the atomisation. Micro-explosions occur as a result of the formation, growth and bursting of vapour bubbles within the superheated droplets. As the oil can sustain very high temperatures during combustion, the water droplets can be superheated. The emulsion droplets are eventually shattered by the internal formation of water bubbles and their rapid vaporisation. This process is called secondary atomisation; it increases the evaporation surface area and the mixing of the burning species in air. The amounts of particulates and smoke formed are minimised [157, Molero de Blas 1995]. This technique does not provide additional benefits for modern oil boilers.

Auxiliary steam boilers are generally fuelled with gas oil. Such boilers often operate only a few hundred hours per year, are usually not equipped with specific abatement techniques and discharge their flue-gas through the stack of the main unit.

Heavy fuel oil and/or gas oil is sometimes used for additional firing in heat recovery boilers or as a supplementary fuel in natural-gas-fired plants, where it can also be used as back-up fuel.

6.1.3.2 Compression ignition (diesel) engines

For information on combustion engine processes, see Section 2.3.2.

Combustion engines operating with heavy fuel oil and/or gas oil are cost-efficient solutions for baseload electricity supplies at remote sites like islands. In areas where gas will be available in the near future, operating on HFO and/or gas oil is also a suitable solution until the plant is converted to gas operation. After the conversion, HFO can be used as a back-up fuel.

6.1.3.3 Liquid-fuel-fired gas turbines

For general information on gas turbines, see Section 2.3.3.

Two types of liquid-fuel-fired gas turbines are currently used: heavy-duty gas turbines and gas turbines derived from aeroplane engines, so-called aeroderivative gas turbines.

Gas turbines in general and aeroderivatives in particular usually run on gas oil or on kerosene. In Europe, there are both large and small gas turbines powered with liquid fuels (not just as the back-up fuel).

The use of heavy fuel oil and naphtha in gas turbines can be decided only with a plant-specific assessment. Additionally, for units that accept these fuels, the turbine inlet temperature must be reduced, which has consequences on the performance. For these reasons, the use of such fuels for gas turbines is rare.

For recent designs of turbines with high turbine inlet temperatures, the manufacturers' specifications for fuel supplies are very stringent. They stipulate the physical and chemical properties needed in order to meet both the equipment demands and the environmental standards, particularly with regard to metal contaminants (sodium, potassium, lead, vanadium and calcium), sulphur and ashes.

The cost and availability of gas oil and the stress imposed on gas turbine blades and on the other parts of the turbine when firing gas oil compared with natural gas, play a significant role when selecting a combustion process.

6.1.4 Control of emissions to air

When using heavy fuel oil (HFO) and/or gas oil, emissions of SO_x and NO_x arise respectively from the sulphur and, besides thermal NO_x formation, to a certain extent from the nitrogen contained in the fuel. Dust originate mainly from the ash content and marginally from heavier fractions of the fuel [158, UFIP 2001]. The presence of dust can also give rise to economic costs for the operators, from losses due to unburnt fuel and from deposits in the combustion hardware, if the equipment is not well maintained.

Particulate emissions from the combustion of HFO may contain two major fractions [157, Molero de Blas 1995]:

- i. material arising from the organic content of the fuel and its incomplete burnout:
 - unburnt hydrocarbons (smoke),
 - dust formed via the gas-phase combustion or pyrolysis (soot),
 - cenospheres produced from cracked fuel or carbon along with ash (coke);
- ii. ash from the inorganic and sulphur content of the fuel.

Smoke may arise from unburnt fractions of hydrocarbon fuel exhausted in the form of a fine spray. Such hydrocarbon fractions are the remainders of reactions frozen by thermal quenching. Emissions of unburnt hydrocarbons are highest at high equivalence ratios (fuel-rich conditions). Their main environmental effect is their reactions in the atmosphere with NO_x and sunlight to form photochemical smog.

Soot is formed in gas-phase reactions of vaporised organic matter in a complex process involving fuel pyrolysis, polymerisation reactions, nucleation, particulate growth, and burnout. Fuel droplets burning in envelope flames are subjected to very high temperatures, leading to fuel evaporation and thermal cracking of the large molecular structures, thus resulting in species with a higher C/H ratio than the fuel source. Soot is most likely to be formed in fuel-rich conditions, and is normally fully burnt as it mixes with air at a very high temperature in highly oxidising zones, e.g. as secondary air is injected into the combustion chamber of a gas turbine.

Cenospheres are formed in liquid-phase processes and contain all the non-soot carbon and part of the ash material. Such particulates are, hollow, porous and nearly spherical, and they range in size from 1 μm to 100 μm .

Ash fouling and corrosion are major problems when burning heavy fuel oils. Vanadium and sodium are the most harmful elements, forming vanadium pentoxide (V_2O_5) and sodium sulphate (Na_2SO_4) respectively. Ash deposits jeopardise heat transfer to metallic surfaces and cause corrosion of the combustion hardware, thus decreasing the equipment lifetime. Values given in the literature [157, Molero de Blas 1995] show that a mere 0.32 cm thick deposit can cause a 10 % decrease in turbine power.

Optimal combustion conditions are therefore important for the minimisation of dust and ash production. Viscous fuel must be preheated before atomising. Additives combine with fuel constituents and combustion products to form solid, innocuous products that pass harmlessly through the combustion equipment. Additives could largely reduce the amount of unburnt carbon to a value as low as 5 wt-% in the collected ashes. A low content of unburnt carbon-in-ash is desirable as optimum burnout allows an optimum efficiency or fuel utilisation. However, depending on technical and fuel characteristics, the content of unburnt carbon-in-ash may be higher when firing HFO. Ashes with a high carbon content are black, while those with a low carbon content are yellow or grey.

When burning gas oil, the dust mainly consists of soot and hydrocarbons.

At the high temperatures typical of combustion, sulphur combines with carbon, hydrogen and oxygen to form SO_2 , SO_3 , SO, CS, CH, COS, H_2S , S and S_2 . Under such conditions and sufficient oxygen concentrations, virtually all the sulphur is converted to oxidised forms, with SO_2 as the predominant sulphur compound formed in combustion. Even with a 20 % air deficiency, 90 % of the sulphur is in the form of SO_2 and as little as 0.1 % is as SO_3 , with SO accounting for the remainder of the sulphur.

At a lower oxygen concentration (40 % air deficiency), H_2S , S_2 and HS are also present in significant proportions, while SO_3 is negligible. During combustion, these species are in super-equilibrium concentrations. As the gases cool, their rates of consumption decrease and equilibrium may be 'frozen' before the products reach room temperature. [157, Molero de Blas 1995]

In oxygen-rich and stoichiometric flames, which are very close to normal operations in boilers, SO₂ and a very small amount of SO₃ are present. SO₃ has to be as low as possible to minimise H₂SO₄ (sulphuric acid) formation, which is responsible for corrosion in the coldest sections of the boiler.

Cost-effective and technically suitable primary and secondary flue-gas cleaning techniques are the focus of current product development. The application of primary methods to reduce emissions to air at source is generally preferable to end-of-pipe abatement, also for cost-effectiveness. Typically, combinations of primary and end-of-pipe techniques are implemented for the control of the key pollutants.

The emission of sulphur oxides is proportional to the sulphur content of the fuel, unless secondary abatement techniques are in place. The primary method to reduce SO_x emissions is to use a fuel with a lower sulphur content, whenever commercially available. Switching to low-sulphur oil can make a significant contribution to reducing SO_x emissions. A decrease of 0.5 % in the oil sulphur content leads to a decrease in the SO₂ emission value of about 850–880 mg/Nm³ at 3 % oxygen in the flue-gas. The sulphur content of gas oil is regulated by Directive 2012/33/EU amending Directive 1999/32/EC, and since 2008 should be below 0.1 wt-%. Such a low sulphur content ensures that SO₂ emissions from gas-oil-fired boilers, engines and gas turbines oil are limited. Directive 2012/33/EU also amends the provisions of Directive 1999/32/EC relating to the maximum sulphur content of heavy fuel oil. The Directive states that heavy fuel oils with a sulphur content exceeding 1 % by mass are not to be used within the EU. Combustion plants using heavy fuel oil with greater sulphur concentrations are required to limit their SO_x emissions to within the limits set by a permit issued by the competent authority. The directive also contains provisions for marine fuels, e.g. those limiting the maximum sulphur content of marine fuels used within the EU Member states' territorial seas, exclusive economic zones and pollution control zones to 0.5 % as from January 2020.

Multi-fuel firing, i.e. simultaneously burning liquid and gaseous fuels or liquid fuel and biomass, could also make significant contributions to reducing SO₂ emissions. Multi-fuel firing can take place in the same burner or in different burners located in the same combustion chamber.

With conventional fuels, the NO_x formation rate depends on the gas temperature and on the amount of nitrogen in the fuel. Both characterise the most important routes for the formation of NO_x. Thermal NO_x can be controlled by a reduction of the peak flame temperature (e.g. limited combustion chamber load).

6.1.4.1 Primary control techniques for emissions to air from boilers

Highly viscous and high-sulphur oils are combusted in boiler-based LCPs. In older oil-fired boilers, burners with mechanical atomisation were installed. Newer improved burner designs include steam atomisation, which gives a more efficient combustion of HFO, and results in lower dust emissions. Dust emission concentrations in the raw flue-gas (before dedusting) lower than 100 mg/Nm³ may be achieved, depending on the ash content of the HFO. Dust emission concentrations of 50 mg/Nm³ in the raw flue-gas may be achieved for low-ash HFO (e.g. ash < 0.02 %, asphaltene < 2 % and Conradson residue carbon content < 8 %), regardless of the burner type. [93, Eurelectric 2011]

The NO_x concentration in the flue-gas of an oil-fired boiler decreases with excess air. The boiler size and burner and oil atomisation design play an important role in the concentration of NO_x in the flue-gases.

For oil-fired boilers, the usual excess air is in the range of 1.5–2.5 % O₂ (in flue-gas). Low excess air combustion is characterised by 1–1.5 % O₂. This technique is rarely used alone, but is very often used in combination with low-NO_x burners (LNBs) or overfire air (OFA).

Flue-gas recirculation is often used in combination with low-NO_x burners and/or OFA, together achieving a 60–75 % NO_x reduction efficiency.

Of all the **air-staging** techniques, the most commonly used in oil-fired boilers are ‘burners out of service’ (BOOS) and OFA. With modern OFA designs (optimised nozzle design, separated and swirled or orientable air flux), the NO_x reduction can be as high as 60 % in tangential firing units. The BOOS technique is also used in the retrofit of existing units.

Flue-gas recirculation burners are used in oil-fired boilers matched with various types of **low-NO_x burners** [158, UFIP 2001], and achieve a NO_x emission reduction of 20 %. The key point in designing efficient oil LNBS is to ensure a good oil atomisation coupled with the burner aerodynamics, so as not to increase the carbon-in-ash level while decreasing NO_x, and while keeping a moderate air excess. Recent LNB designs with a proper oil atomisation system can reach a 50 % NO_x reduction.

In oil-fired boilers, **fuel staging** [158, UFIP 2001] can be implemented with gas or oil as the reburning fuel. Gas is more commonly used than oil. Fuel staging is interesting for new power plants but is less adapted to existing units. Many existing oil-fired boilers were equipped with gas/oil fuel staging during the 1990s (e.g. units from 35 MW_e to 660 MW_e are in service in Italy). These units were all equipped with at least OFA and flue-gas recirculation at the same time, and some of them with low-NO_x burners. The share of the fuel staging is 10–20 % of the total thermal input. The corresponding NO_x reduction efficiency is 50–80 % for oil staging and 65–80 % for gas staging.

6.1.4.2 Primary control techniques for emissions to air from engines

The main pollutants emitted in the exhaust of a typical diesel engine burning heavy fuel oil (compression ignition engine) include nitrogen oxides (NO_x), dust (PM) and sulphur oxides (SO_x). Thanks to the high combustion temperature, emissions of carbon monoxide and unburnt hydrocarbons are low.

When combusting heavy fuel oil, the dust mainly consists of the ash and sulphur (resulting in sulphate) content of the fuel oil and, to a smaller extent, of soot and hydrocarbons. With gas oil, the dust mainly consists of soot and hydrocarbons.

The control of combustion parameters, together with regular maintenance of the combustion system (checking/replacement of injectors), is a primary technique to control particulate emissions from large engines. The combustion parameters to be controlled are: fuel atomisation quality, performance of the equipment dedicated to fuel treatment/warming up, and the air-to-fuel ratio.

NO_x emissions from large liquid-fuel-fired diesel engines have been reduced considerably by primary techniques resulting from extensive research and development work, whilst maintaining high engine energy efficiency. Since NO_x formation in engines is a function of the flame temperature and residence time, the focus of these techniques is to reduce the peak temperature and thus suppress thermal NO_x formation in the cylinder. Some primary techniques are as follows:

- A baseload engine optimised for low NO_x and good fuel consumption is equipped with: Miller valve timing (early inlet air valve closing, causing the air entering the cylinder to expand and cool and hence reduce temperature peaks during combustion) to optimise the NO_x-fuel consumption trade-off, a high pressure ratio turbocharger to maintain the engine output with high Miller timing, a high compression ratio to optimise the NO_x-fuel consumption trade-off, and fuel injection rate shaping.
- Fuel injection timing retards.

- The addition of water (water injection directly into the combustion space or water-in-fuel emulsion or humidification of the combustion air).
- Exhaust gas recirculation.
- Use of a dual fuel engine (in gas mode), which often uses the ‘lean-burn’ technique with lower NO_x.
- Higher engine speed. Fuel-efficient, large-bore, low-speed engines tend to have higher NO_x emissions than faster running smaller engines. When the engine speed is lower, NO_x concentrations are higher in the combustion chamber because of the longer time available to form NO_x.

6.1.4.3 Primary control techniques for emissions to air from gas turbines

Thermal NO_x formation can be restricted by decreasing the combustion temperature. This is accomplished by the premix burner technique (dry low-NO_x or **DLN technique**), where fuel is blended with the combustion air in order to avoid excessive peak flame temperatures. This, however, only operates when the unit is operating at sufficiently high load. A different combustion method is applied for low-load operation, start-up and shutdown, in order to avoid flashback.

Applying staged combustion in gas turbines at lower temperatures requires a different gas turbine design.

Wet abatement emission reduction processes: Steam/water addition is also used to reduce combustion temperatures and consequently NO_x emission levels. Water or steam is injected into the combustion chambers in order to reduce the combustion temperature, thus avoiding the formation of thermal NO_x. Water is used for injection in gas turbines (GTs) operating in open cycle, while steam is most often used for GTs operating in combined cycle or in a cogeneration system. A fuel oil and water emulsion is also an option. Compared to water injection, the use of a fuel oil and water emulsion reduces water usage by around 25–30 % at the same NO_x reduction rate.

If gas oil is used only as a standby fuel in large-capacity GTs running generally with gas, direct water injection systems allow the reduction of NO_x emissions when running with gas oil. In fact, DLN for gas oil operation only exist for smaller GTs (< 100 MW_{th}), and may have operating time limitations (e.g. < 1 500 h/yr as constructor’s specification for some models).

[92, Freimark et al. 1990]

6.1.4.4 End-of-pipe techniques to control emissions to air

6.1.4.4.1 Control of dust emissions

Dust emissions can be reduced by applying secondary dedusting devices such as ESPs and bag filters, as in the case of dust emissions from boilers. Bag filters for dust have already been installed in recent diesel engines together with the use of sorbent injection for FGD. The sorbent dilutes the potentially sticky ash/soot that might otherwise cause clogging problems.

In ESPs, dust is generally collected in a dry form, which can then be landfilled in controlled landfills. However, in combination with SO₂ wet scrubbing, the wet ESP technique is applicable after the FGD for particulate removal. A dry ESP could be used before the wet FGD. [93, Eurelectric 2011]

As the temperature and oxygen content of the flue-gas differ between a diesel engine and a boiler, the electrical properties of the particulates (e.g. resistivity) differ also, and the performance of the ESP differs between these two combustion processes.

6.1.4.4.2 Control of SO_x emissions

To reduce SO_x emissions from liquid-fuel-fired boilers, including especially those burning HFO, some plants apply wet scrubbers. Wet scrubbing with gypsum as the end-product is the best performing process for desulphurisation. Nevertheless, due to economic and operational constraints, it might not be applicable to smaller plants. In smaller plants, flue-gas desulphurisation may be carried out with lime or limestone dry processes, lime semi-dry processes, activated carbon processes, or soda and sodium bicarbonate processes.

Dry desulphurisation may be improved by managing an 'open pass' on the inside of the boiler, which increases the contact time at a constant of temperature between sorbent and flue-gases. The choice between the above processes depends on the required yield of desulphurisation and on local considerations, i.e. mainly utilisation or landfilling of the desulphurisation by-products and residues.

A few DeSO_x systems were installed over the years in connection with HFO/Orimulsion-fired diesel engines. Today the majority of these FGD systems are no longer in operation due to a fuel change to natural gas. Diesel engine flue-gas differs from boiler flue-gas: for instance, it has a high oxygen content and flow rate, which might have an impact on the reactions in and size of the DeSO_x system. It must also be noted that, due to the high specific flue-gas flow of a diesel engine (lambda typically about 2.7), the size of the DeSO_x system will be relatively big.

Most of the examples of DeSO_x systems in diesel power plants so far are wet scrubbers using a NaOH (about 50 wt-%) water solution as the reagent. The flue-gas is washed with the reagent water solution and the SO₂ is removed. The main components of the system are the reagent storage tank and transportation system, a scrubber with recirculation pumps, and an oxidation tank.

In larger diesel power plants, other DeSO_x systems (e.g. wet CaCO₃ scrubbers, in-duct sorbent injection before a bag filter) have been used.

6.1.4.4.3 Control of NO_x emissions

Secondary techniques for NO_x reduction such as SNCR and SCR have been applied to a number of oil-fired boilers. For existing boilers running with frequent and intense load variations, SCR and SNCR need to be properly designed and fine-tuned to cope with the variable conditions.

SNCR can be applied to oil-fired boilers of any size. SNCR techniques include the use of liquid NH₃ solution, gaseous NH₃, and urea in solution or solid urea as reduction agents. The reduction agent is injected into the boiler chamber in areas where the temperature is around 900 °C. SNCR requires a good knowledge of the temperature distribution in the combustion chamber at all rates, and a good control of the amount of injected reagent. Control can be achieved by NH₃ or NO_x monitoring; NO_x reduction could reach 60 %, with a NH₃ slip lower than 7.5 mg/Nm³.

SCR is a proven technique for liquid-fuel-fired combustion plants.

In Europe, SCR is applied, including to boilers operated for peaking applications, for example in Austria, Germany, Italy and the Netherlands. Outside Europe it is mostly applied in Japan.

SCR is also applicable for the abatement of NO_x emissions from diesel engines. To date, several hundred engines in power and cogeneration plants in Europe, Asia and the US have been equipped with SCR. They operate with various grades of liquid fuel, ranging from diesel or fuel oil to low-grade heavy fuel oil (180 cSt, 5 % S). SCR in the context of an engine operating on Orimulsion has been tested only in laboratory conditions. An SCR system can be equipped with an additional oxidation layer for the reduction of CO and NH₃, but this is not recommended when operating with liquid fuels (such as HFO) containing sulphur. An oxidation catalyst oxidises part of the SO₂ to SO₃ and consequently additional particulates are formed (sulphate). Larger diesel engines have low emissions of unburnt carbon. When the NO_x reduction rate is up to 85–90 %, the SCR can be controlled by a simple control system; with higher NO_x reduction rates, complex reagent premixing and injection systems, as well as a more advanced control system, are needed. Diesel engines operated frequently in isolated systems for a reduced number of hours may be operated with often varying loads. Depending on the electricity demand, these engines may need to be started up and shut down several times a day. In such cases, the SCR catalyst temperature may frequently fluctuate outside the necessary effective temperature window.

Some gas turbine combined-cycle plants in Europe, particularly in Austria, France, Germany, Italy and the Netherlands, have also applied SCR to reduce NO_x emissions, including when running on gas oil. In the US, SCR is commonly used for gas turbines, including those operated with liquid fuels.

[94, Eurelectric 2012]

6.1.5 Water consumption and waste water treatment

In boilers, demineralised water is required to compensate for the blowdown water from the drums, water sampling, water or steam leakage and steam blasting. Condensates from boiler blowdown can be reprocessed and recycled to the condenser, which spares the corresponding amount of make-up demineralised water. The quality of the water has to fulfil the requirements of the boiler manufacturers, which usually requires water treatment. Demineralisation may not be sufficient to meet these requirements and conditioning, as well as water degassing, may be needed before injection into the boiler.

For gas turbines and for HRSG systems, demineralised water is required for the following purposes:

- As make-up water for the HRSG, to compensate for the blowdown water from the drums. Demineralisation is usually sufficient to meet the manufacturers' quality requirements for this use.
- Water injection for NO_x abatement (approximately 1 kg water to 1 kg fuel). If steam or water injection is applied, the water loss has to be compensated for by adding make-up water.
- For washing the gas turbine compressor, demineralised water is normally used. For online washing, condensate from the water/steam cycle is sometimes used, but more often demineralised water is supplied to a separate water wash unit. For offline washing, a detergent is added to the demineralised water to improve the washing effect.

The techniques described for waste water treatment in Chapter 3 are, to a large extent, applied for the treatment of waste water from liquid-fuel-fired plants.

Operation of the gas turbine and the HRSG (if applied) leads to the following waste water streams:

- Blowdown water from the boiler circulation system to maintain the quality of the boiler water. The boiler water usually contains additives to protect the boiler from corrosion,

such as ammonia, sodium hydroxide, and/or phosphates. In practice, in most existing units, this blowdown water is quenched and discharged to sewerage systems or to a water treatment plant if needed. This blowdown water can also be reconditioned and recycled as make-up water, since it has better parameters (no O₂, little conductivity, no TOC) than raw water.

- Waste water from the gas turbine water washing processes, which can be discharged or has to be considered chemical waste, depending on the detergents used in the washing and on the materials for disposal from the compressor.
- Water contaminated with oil or oil-containing fluids, which is usually collected and treated separately in a water treatment plant.
- Remaining waste water from the plant, such as scrubbing water, which is treated or directly discharged to the sewerage system.

An engine-driven power plant usually preserves its water. The cooling circuits contain about 20–30 % of the input fuel energy. The cooling circuit energy must be cooled away, if it cannot be utilised in another CHP process. This can be achieved through cooling towers using water or air-cooled radiators. Cooling towers use moderate flows of cooling water and in the case of air-cooled radiators a very small make-up water flow is needed for the engine's internal cooling circuits. Traditional techniques are used in the treatment of the waste water. A result of the low water requirement is a small discharge of waste water, and consequently low thermal pollution of the surrounding watercourses. Another consequence is a low usage of different water purification chemicals on site and a limited risk, therefore, of chemical spillages.

A single-cycle 130 MW_e oil-fired diesel power plant equipped with cooling towers typically consumes about 220 m³/h of raw water (plant without DeSO_x). Air-cooled radiators are very suitable for engine-driven plants. In the example 130 MW_e oil-fired diesel plant, if equipped with radiators, the make-up water needed (mainly for fuel oil and lube oil separators, make-up water for the engine cooling circuit, turbo wash water, etc.) would be typically in the order of 5 m³/h or less.

6.1.6 Combustion residues treatment

Ash resulting from fuel oil combustion could have a high carbon content and, in this case, it can be incinerated. However, good combustion conditions of the liquid fuel, produce ash with a low carbon content (lower than 20 %), which could be disposed of in controlled landfills.

Final sludges are dewatered, dried, solidified and incinerated, or disposed of by authorised contractors. Water from sludge dewatering, which is contaminated with oil or fluids containing oil, is usually collected in a specific system and treated separately. Sludge is also collected from the treatment of washing effluents from the air preheaters, boilers from the flue-gas side and from other equipment.

6.2 Current emission and consumption levels

6.2.1 Liquid fuels used in large combustion plants

The composition of a particular crude oil is unique and cannot be precisely defined. As a rough guide, it contains alicyclic, cyclic and aromatic hydrocarbons; compounds of sulphur, nitrogen and oxygen; and traces of other compounds containing Ni, Fe, V, Mo, Cl, F, etc.

Heavy fuel oils (HFO) are products derived from crude oils, and their composition varies with that of the source crude. They are composed entirely, or substantially, of the residuals or bottoms from petroleum refining operations, i.e. materials that remain in a condensed form during processing. The atmospheric distillation temperature for these components exceeds 540 °C, and they appear after all the other lighter products have been removed from the refinery stream.

Some physico-chemical properties of HFO and gas oil in comparison with other liquid fuels are given in Table 6.1, Table 6.2 and Table 6.3.

Table 6.1: General characteristics of liquid fuels

Property	Unit	Gas oil	Heavy fuel oil	Refinery bottom product
Carbon content	%	NA	84–90	85–88
Hydrogen content	%	NA	10–13	8–12
Sulphur content	%	< 0.1	< 1	1–4
Water content	%	< 0.02	< 1.5	< 0.5
Sediment content	%	< 0.1	< 0.25	< 0.2
Sodium content	ppm	NA	1–200	NA
Vanadium content	ppm	NA	1–200	200–350
Kinematic viscosity (20 °C)	mm ² /s	< 9.5	> 28.4	NA
Flashpoint (flammability)	°C	> 55	> 70	NA
Density at 15 °C	kg/dm ³	0.87	0.94–1.04	NA
Higher heating value	MJ/kg	45	41.5–44.5	NA
Lower heating value	MJ/kg	42	39.5–42	38–40

NB:
NA: Not available.
Sources: [123, Eurelectric 2001] [94, Eurelectric 2012]

Table 6.2: Chemical properties of several typical heavy fuel oils

Property	Unit	High sulphur	Intermediate sulphur	Low sulphur
Sulphur	wt-%	2.2	0.96	0.50
Carbon	wt-%	86.25	87.11	87.94
Hydrogen	wt-%	11.03	10.23	11.85
Nitrogen	wt-%	0.41	< 0.5	0.16
Ash	%	0.08	< 0.06	0.02
Vanadium	ppm	350	< 60	< 20
Nickel	ppm	41	20	10
Sodium	ppm	25	10	< 40
Iron	ppm	13	9	< 5

NB: When heavy fuel oil contains less sulphur (e.g. 0.2–0.5 %), in general the ash, nitrogen, asphaltene, and Conradson carbon residue contents are also lower.
Source: [157, Molero de Blas 1995] [94, Eurelectric 2012]

Table 6.3: Properties of Orimulsion

Property	Unit	Values for Orimulsion
Density (at 15 °C)	kg/m ³	1010
Viscosity (at 50 °C)	cSt	350
Water	%-vol	28–31
Sulphur content	%-wet	Max. 3 %
Ash arising	mg/kg	0.14–0.2
Vanadium	mg/kg	300–365
Sodium	mg/kg	30
Magnesium	mg/kg	6
Lower heating value	MJ/kg	27–28

Source: [160, EUROMOT 2000]

HFOs usually contain higher amounts of sulphur than other petroleum products, as it tends to concentrate in the residue along with asphaltenes during the refining processes.

Of the fuel oils, HFO is the most commonly used LCP fuel, whereas only small amounts of gas oil are used at LCPs, mostly due to its high price.

The ash content of HFO is usually well below 0.2 wt-%.

Gas oil is mainly used in gas turbines when natural gas is not available, in some auxiliary boilers, in some engines and as auxiliary fuel in coal-firing LCPs.

Since the oil flame temperature is high, thermal NO_x formation can sometimes be very high depending on local burner combustion conditions. The fuel NO_x formation can vary significantly as the nitrogen content strongly depends on the quality and source of the oil. [94, Eurelectric 2012] [130, Finland 2000]

6.2.2 Efficiency of combustion plants firing HFO and/or gas oil

The design boiler efficiency for a new boiler using liquid fuel is around 95 % (lower heating value basis). The main losses are from flue-gas waste heat at the stack, unburnt carbon-in-ash, and radiation losses.

The efficiency of an oil-fired boiler is closely linked to the nature of the fuel and to the ambient air temperature. However, optimisation of some parameters is possible:

- **Unburnt carbon-in-ash:** Combustion optimisation leads to less unburnt carbon-in-ash. It should be noted that NO_x abatement techniques, with combustion modification, show a tendency towards increased unburnt carbon.
- **Air excess:** The amount of excess air depends on the boiler type. Typically, 5–8 % excess air is common for oil-fired boilers. For reasons of combustion quality (i.e. related to CO and unburnt carbon formation), corrosion and safety, it is often not possible to further reduce the excess air.
- **Flue-gas temperature:** The temperature of the flue-gas leaving the boiler (depending on fuel type) is traditionally between 120 °C and 220 °C, to avoid acid corrosion by the condensation of sulphuric acid. However, some designs incorporate a second stage of air heaters to lower this temperature below 100 °C, with special claddings on the air heater and the stack.

Another aspect that influences LCP efficiency is the energy consumption of auxiliary equipment, which depends on a number of parameters:

- **Level of pollution control:** advanced FGD consumes more energy, and pollution control generally has a penalty on energy efficiency.
- **Design of auxiliaries:** boiler auxiliaries have to be overdimensioned to withstand all the variations in parameters in comparison with design values (possible leaks, alternative fuels, start-up needs, redundant systems, etc.). These technical options lead to non-optimum auxiliary energy consumption under nominal conditions and design fuel.

Typically, the specific fuel consumption is 0.242 kg/kWh_e for HFO-fired boilers and 0.205–0.225 kg/kWh_e for HFO-fired engines.

6.2.3 Emissions to air from liquid-fuel-fired combustion plants

The range of emissions to air from HFO- and gas-oil-fired combustion plants (boilers, HFO- and/or gas-oil-fired engines and gas-oil-fired gas turbines) are given in Table 6.4. Reference conditions are dry flue-gas, 3 % oxygen for boilers, 15 % for engines and gas turbines, and normal operating conditions. Unless stated otherwise, data represented are yearly averages of short-term values, and averages of samples obtained over one year without subtraction of uncertainty or long-term estimates. Ammonia emissions are associated with the use of SCR/SNCR.

Table 6.4: Range of yearly emissions to air from HFO- and/or gas-oil- fired combustion plants

Type of plant	Total rated thermal input (MW _{th})	Abatement techniques			Emissions to air (mg/Nm ³)					
		SO ₂	NO _x	Dust	SO ₂	NO _x	NH ₃ ⁽¹⁾	Dust	CO	TVO C
HFO- and/or gas-oil-fired boiler	< 100	Fuel choice/ Flue-gas conden ser/ DSI	Fuel choice/ Air staging/ Fuel staging/ LNB	Fuel choice/ Multicy clone/ ESP/ Bag filter	12– 1676	182– 576	NA	0.5– 54	3–85	NA
	100– 300		LNB/ Steam addition/ Air staging/ FGR/ SCR							
	≥ 300	Fuel choice/ Wet FGD		Fuel choice/ ESP	51– 750	46– 511	< 3	0.1– 116	3–52	NA
HFO- and/or gas-oil-fired engine	All	Fuel choice/ Low-NO _x combustion concept in diesel engines/ SCR/ DSI/ Bag filter			93– 604	118– 2442	5–9	5– 200	44– 200	5–75 ⁽¹⁾
Gas-oil-fired gas turbine		Fuel choice/ Water or steam addition			1–115	102– 1085	NA	1–7	1– 680	NA

⁽¹⁾ Emissions reported by HFO-fired engines.
 NB:
 DSI: Duct sorbent injection; Wet FGD: Wet flue-gas desulphurisation; ESP: Electrostatic precipitator; BF: Bag filter; SCR: Selective catalytic reduction of NO_x.
 NA: Not available.
 Source: [3, LCP TWG 2012]

6.3 Techniques to consider in the determination of BAT for the combustion of liquid fuels

This section describes techniques (or combinations thereof), and associated monitoring, considered to have the potential for achieving a high level of environmental protection in the activities within the scope of this document. The techniques described include both the technology used and the way in which the installations are designed, built, maintained, operated, and decommissioned.

It covers process-integrated techniques and end-of-pipe techniques. Waste prevention and management, including waste minimisation and recycling procedures, are also considered. Furthermore, techniques for reducing the consumption of raw materials, water, and energy are covered.

Annex III to the Industrial Emissions Directive lists a number of criteria for determining BAT, and the information within this chapter addresses these considerations. As far as possible, the standard structure of Table 3.4 is used to outline the information on each technique, to enable a comparison of techniques and the assessment against the definition of BAT given in the Industrial Emissions Directive.

This section does not necessarily provide an exhaustive list of techniques that could be applied in the sector. Other techniques may exist, or may be developed, which could be considered for the determination of BAT for an individual installation.

In this section, the techniques to be considered have only been fully described when they are specific to the considered combusted fuel or applied combustion process (combustion of liquid fuels). Indeed, for most of the techniques, general descriptions are already presented in Chapter 3. Therefore, in order to avoid repetition, for those general techniques already described in Chapter 3, only the additional information that is specific to the combustion of liquid fuels is reported here in synthesis tables.

6.3.1 Techniques to prevent emissions to soil and groundwater

Information on general techniques for the prevention of emissions to soil and groundwater from the handling and storage of fuels, additives, by-products and wastes is given in Section 3.2, while Table 6.5 gives additional information on the specific case of liquid fuel combustion, e.g. on environmental performances and example plants.

Table 6.5: Techniques for the prevention of emissions to soil and groundwater

Technique	Technical description	Achieved environmental benefits	Environmental performance and operational data	Technical considerations relevant to applicability		Economics
				New plants	Existing plants	
Tanks grouped inside a retention basin	The retention basin should be designed to hold all or part of the volume	Reduced risk of water and soil contamination	High operational experience	Generally applicable		NA
Automatic control systems	Automatic control systems to prevent overflowing of storage tanks					
Alarms and procedure settings	Installation of alarms and procedure settings to detect possible emissions					
Double-walled pipes	Double-walled pipes with control of the spacing for underground pipes					
Regular checks	Regular checks of the storage facilities and piping					
Surfaces with drainage systems (including oil traps)	Liquid-tight paving (e.g. concrete) in areas with drainage systems where operations that could result in soil contamination are carried out. Oil traps could be installed. The collected drainage water needs to be treated to avoid water contamination by fuel or lubrication oil	Prevention of groundwater and soil contamination		Generally applicable	Limited applicability	Cost of waste water treatment
NB: NA: No relevant specific information available.						

6.3.2 Techniques to consider in the determination of BAT for the combustion of HFO and/or gas oil in boilers

6.3.2.1 Techniques to improve the general performance

Information on general techniques to improve the environmental performance of plants is given in Section 3.1.1, while

Table 6.6 gives additional information on the specific case of HFO and/or gas oil combustion in boilers, e.g. on environmental performances and example plants.

Table 6.6: Techniques to improve the general environmental performance of HFO- and/or gas oil fired boilers

Technique	Technical description	Achieved environmental benefit	Environmental performance and operational data	Technical considerations relevant to applicability		Economics	Driving force for implementation	Reference literature
				New plants	Existing plants			
Advanced control system	Combination of local combustion-balancing strategies and the implementation of advanced combustion monitoring systems. See also Section 3.2.3.8	<p>NO_x prevention</p> <p>Energy efficiency improvement</p> <p>Auxiliaries consumption</p> <p>Slagging control</p>	<p>NO_x reductions of around 30 %.</p> <p>Main parameters to optimise:</p> <ul style="list-style-type: none"> • overall excess oxygen, whilst maintaining an adequate local stoichiometry for each burner • flame type (based on appropriate control of the air inputs) • number of active burners for each operating load. <p>The adjustments are made by maintaining appropriate control of the individual operational conditions of each burner, based on the local combustion measurements.</p>		The applicability to old combustion plants may be constrained by the need to retrofit the combustion and/or control command system(s)	Investment: EUR 300 000 to EUR 700 000, depending on the unit capacity, design, baseline operation, etc.	Fuel savings and NO _x reduction	[161, Cañadas, L. et al. 2001] [162, Rodríguez, F. et al. 2002] [163, ECSC 2001]

6.3.2.2 Techniques to increase energy efficiency

Information on general techniques to increase the energy efficiency of combustion plants is given in Section 3.2.3, while Table 6.7 gives additional information on energy efficiency specific to the combustion of HFO and/or gas oil in boilers, e.g. on environmental performances and example plants.

Figure 6.1 shows the operating electrical efficiencies and total fuel utilisation of some European HFO- and/or gas-oil-fired combustion plants commissioned between 1967 and 2009, operated between 30 h/yr and 7 700 h/yr, and with an equivalent full load factor above 16 %.

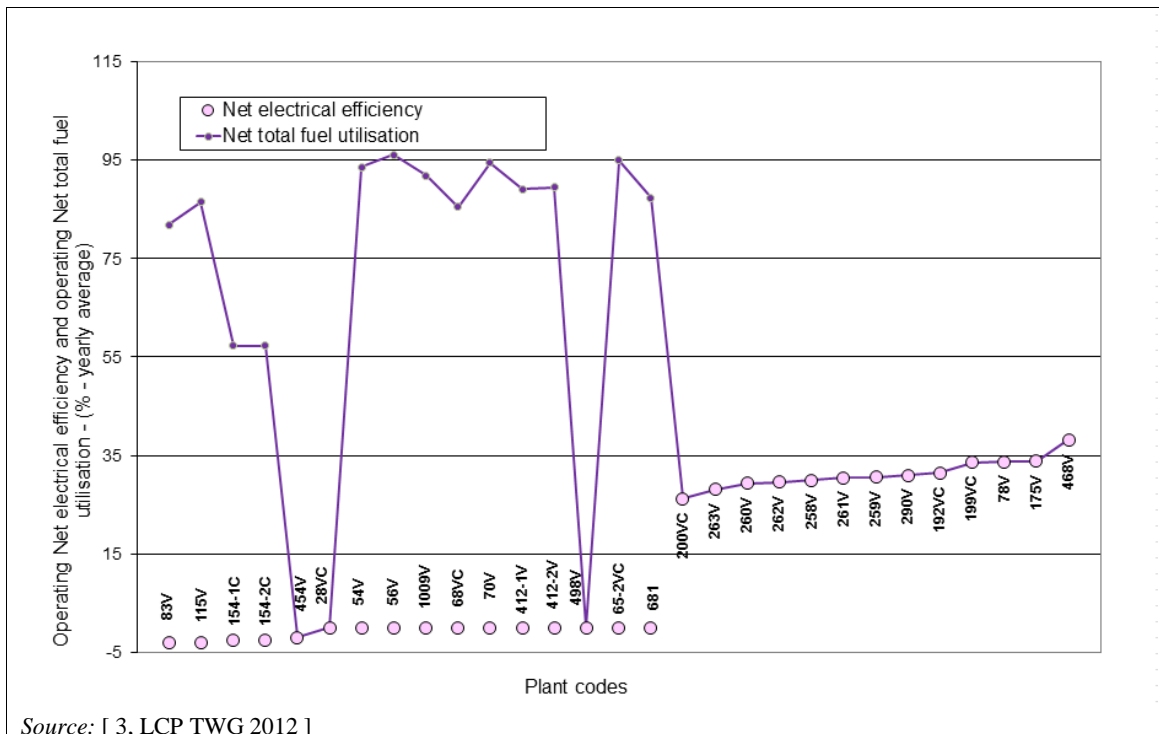

Figure 6.1: Operating energy efficiencies of European HFO- and/or gas-oil-fired combustion units

Design net electrical efficiencies were reported by five plants commissioned up to 2010 in the range of 35.6–37.4 %. [66, TWG Task Force on Energy Efficiency 2014]

Table 6.7: Techniques to increase the energy efficiency of HFO- and/or gas-oil-fired boilers

Technique	Technical description	Achieved environmental benefits	Environmental performance and operational data	Cross-media effects	Technical considerations relevant to applicability		Economics
					New plants	Existing plants	
Heat recovery in CHP plants	See Section 3.2.3.2	Increased efficiency	High operational experience. Specific CO ₂ emission: 370 g/kWh (produced electricity + recoverable heat) when operating on HFO at a total boiler plant efficiency of 80–96 %	None	Applicable within the constraints associated with the local power and heat demand		NA
Change of turbine blades Use of advanced materials to reach high steam parameters	Steam turbine blades can be changed to three-dimensional blades during regular maintenance intervals. See Section 3.2.3.13 The use of advanced materials allows steam pressures up to 300 bar and steam temperatures of 560–570 °C. See Section 3.2.3.5		High operational experience Practised in new plants	Higher furnace wall temperature may increase NO _x emissions	Generally applicable to plants where the combustion energy is transferred to a steam cycle (e.g. boilers) Generally applicable to plants where the combustion energy is transferred to a steam cycle (e.g. boilers). Increased steam temperature is limited by the corrosion potential of fuel oil		
Supercritical steam parameters	See Section 3.2.3.14	Increased efficiency	Practised in new plants	None	Generally applicable to plants where the combustion energy is transferred to a steam cycle (e.g. boilers). Increased steam temperature is limited by the corrosion potential of fuel oil		

Double reheat	See Section 3.2.3.6	Increased efficiency	Practised mainly in new plants	NA	Generally applicable to plants where the combustion energy is transferred to a steam cycle (e.g. boilers)	Very limited applicability	NA
Feed-water preheating using recovered heat	New plants use up to 10 stages resulting in a feed-water temperature of about 300 °C. See Section 3.2.3.7	Increased efficiency	Practised in new plants and some existing ones		Generally applicable to plants where the combustion energy is transferred to a steam cycle (e.g. boilers)	Sometimes applicable	
Advanced control system	See Section 3.2.3.8	Increased efficiency	High operational experience		Generally applicable	Plant-specific	
Heat accumulation (Heat storage)	Increases the energy finally used with CHP mode. See Section 3.2.3.9	Increased efficiency and decreased NO _x and CO emissions. Less use of oil-based peak load boilers when unloading the accumulator	NA	NA	Generally applicable	NA	
Cooling tower discharge	Flue-gas discharge through cooling tower. No stack is needed.	Reheating of flue-gas after the FGD plant is not necessary			Generally applicable	No additional cost for construction and maintenance of a stack.	
NB: NA: No relevant specific information available.							

6.3.2.3 Techniques for the prevention and control of NO_x and CO emissions

Information on general techniques for the prevention and control of NO_x and CO emissions is given in Section 3.2.2.3, while Table 6.8 gives additional information on the specific case of HFO and/or gas oil combustion in boilers, e.g. on environmental performances, economics and example plants. Further details on related environmental performance and operational data are provided after the table.

Table 6.8: Techniques for the prevention and control of NO_x and N₂O emissions from HFO- and/or gas-oil-fired boilers

Technique	Technical description	Achieved environmental benefits	Environmental performance and operational data	Cross-media effects	Technical considerations relevant to applicability		Economics	Example plants
					New plants	Existing plants		
Primary techniques								
Fuel choice	See Section 3.1.1.4	Reduction of NO _x	NA	NA	There may be constraints associated with the availability of different types of fuel, which may be impacted by the energy policy of the Member State		Depends on type of fuel	Plant 83
Low excess air	See Section 3.2.2.3.1	Reduction of NO _x and N ₂ O emissions, increased efficiency	High operational experience	Risk of incomplete combustion. Therefore emission of other pollutants may be increased (e.g. CO)	Generally applicable		Plant-specific	NA
Air-staging	See Section 3.2.2.3.2	Reduction of NO _x		Risk of incomplete combustion. Therefore emission of other pollutants may be increased (e.g. CO)				Plant 498
Flue-gas recirculation	See Section 3.2.2.3.3			Slight decrease of energy efficiency				Plant 192
Low-NO _x burners (LNBs)	See Section 3.2.2.3.5	Reduction of NO _x	Liquids used for firing may contain nitrogen compounds, reducing the LNB benefit as LNBs have a relatively small impact on fuel-bound nitrogen. High operational experience	Risk of incomplete combustion. Therefore emission of other pollutants may be increased (e.g. CO)				NA

Fuel staging	See Section 3.2.2.3.6		High operational experience	NA		Plant-specific	Plant 83
Water/steam addition	See Section 3.2.2.3.10		High operational experience	Decrease of energy efficiency. Emission of other pollutants may be increased (e.g. CO)	Applicable within the constraints of water availability	NA	Plant 468
Secondary techniques							
Selective non-catalytic reduction (SNCR)	See Section 3.2.2.3.12.	Reduction of NO _x	NO _x reduction rate of SNCR is less than in the case of SCR. High operational experience	Ammonia slip and ammonia sulphate salts formation Slight decrease of energy efficiency	Not applicable to plants operated < 500 h/yr. The applicability may be limited in the case of combustion plants operated between 500 h/yr and 1 500 h/yr with highly variable boiler loads	Plant-specific	NA
Selective catalytic reduction (SCR)	See Section 3.2.2.3.11 Retrofitted also in high dust position	Reduction of NO _x	Three layers are usually sufficient to achieve 90–92 %NO _x reduction. SCR catalyst regeneration every five years. High operational experience	Ammonia slip. Slight decrease of energy efficiency	Not generally applicable to combustion plants of < 100 MW _{th} . There may be technical and economic restrictions for retrofitting plants operated between 500 h/yr and 1 500 h/yr.	Not viable for plants operated < 500 h/yr	Plants 258, 259
NB: NA: No relevant specific information available.							

Figure 6.2 shows NO_x emission concentrations from well-performing plants of < 100 MW_{th}, all of them using fuel choice as a technique. No evidence of correlation between NO_x emissions concentrations and plant age (commissioning years between 1967 and 2004), load (equivalent full load factor between 35 % and 80 %), or operating hours per year (total operating hours ranging between 30 and 1 200) is observed for the plotted plants.

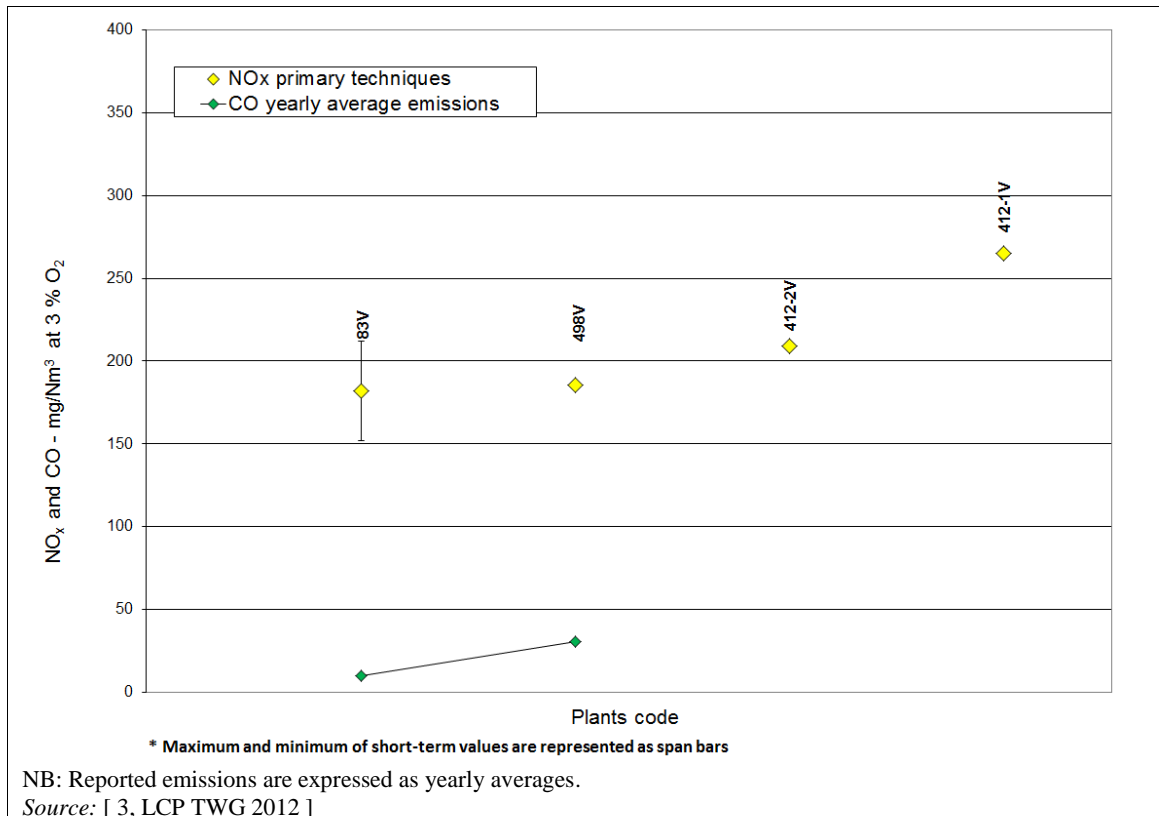

Figure 6.2: NO_x emissions from well-performing HFO- and/or gas-oil-fired boilers of < 100 MW_{th}

Figure 6.3 shows NO_x emission concentrations from well-performing plants of ≥ 100 MW_{th} (total rated thermal input ranging between 100 MW and 800 MW). They continuously monitor NO_x emission concentrations. No evidence of correlation between the NO_x emissions concentrations and the plant age (commissioning years between 1971 and 2006), load (equivalent full load factor between 16 % and 76 %), or operating hours per year (total operating hours ranging between 630 and 5 580) is observed for the plotted plants.

Where this information is available, the plants shown in Figure 6.2 maintain the yearly average CO emissions concentration between 10 mg/Nm³ and 30 mg/Nm³, and the plants shown in Figure 6.3 maintain the yearly average CO emissions concentration between 10 mg/Nm³ and 20 mg/Nm³. The yearly average NH₃ emissions concentrations for the plotted plants are below 3 mg/Nm³.

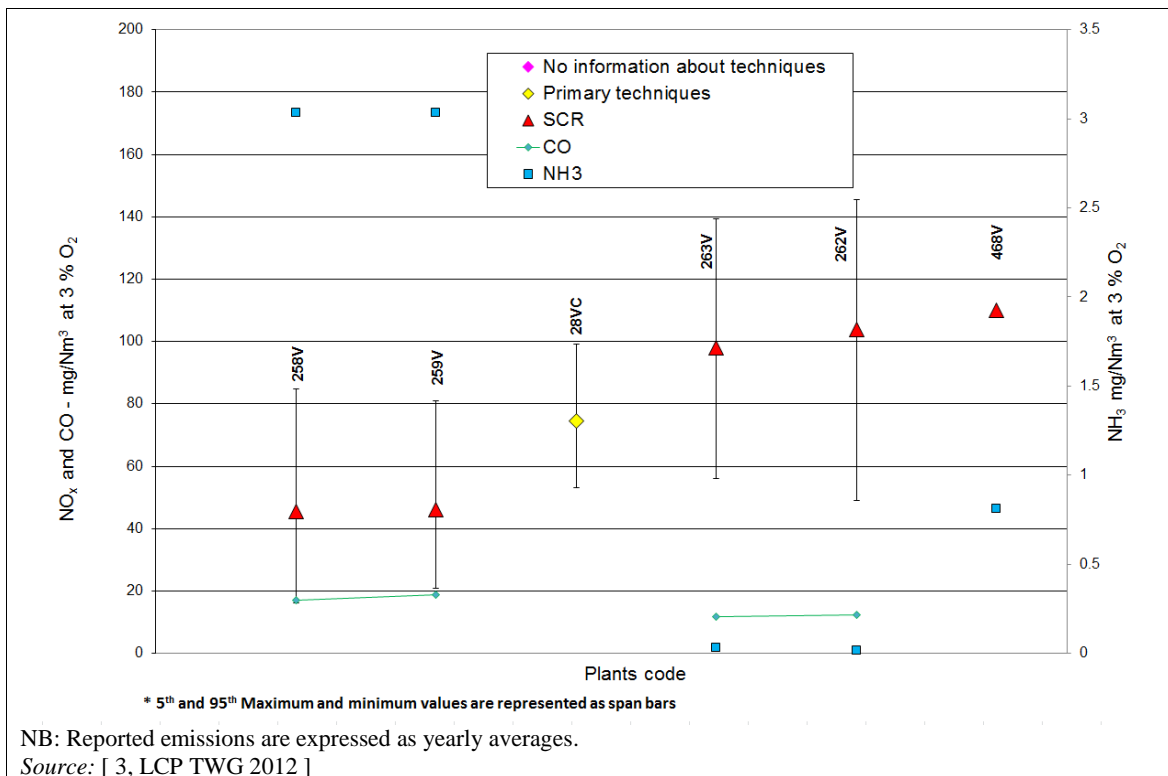

Figure 6.3: NO_x emissions from well-performing HFO- and/or gas-oil-fired boilers of ≥ 100 MW_{th}

6.3.2.4 Techniques for the prevention and control of SO_x emissions

Information on general techniques for the prevention and control of SO_x emissions is given in Section 3.2.2.2, while Table 6.9 gives additional information on the techniques specific to the combustion of HFO and/or gas oil in boilers, e.g. on environmental performances and example plants. Further details on related environmental performance and operational data are provided after the table.

Table 6.9: Techniques for the prevention and control of SO_x emissions from HFO- and/or gas-oil-fired boilers

Technique	Technical description	Achieved environmental benefits	Environmental performance and operational data	Cross-media effects	Technical considerations relevant to applicability		Economics	Example plants
					New plants	Existing plants		
Fuel choice	Primary technique to prevent sulphur emissions. See also Section 3.1.1.4	Reduction of SO _x emissions at source	High operational experience	NA	Applicable within the constraints associated with the availability of different types of fuel, which may be impacted by the energy policy of the Member State		Depends on the type and quality of fuel oil. High operational experience	Plants 83, 454
Wet flue-gas desulphurisation (wet FGD)	See Section 3.2.2.2.1 Existing wet scrubbers can be improved by optimising the flow pattern in the absorber	Reduction of SO _x and dust emissions	SO _x reduction efficiency of > 90 % in retrofitting	Depending on the source of lime, the emissions of As, Cd, Pb and Zn to air might be slightly higher. Emissions to water. Plume formation at the stack outlet if flue-gases are not reheated.	There may be technical and economic restrictions for applying the technique to combustion plants of < 300 MW _{th} .	There may be technical and economic restrictions for applying the technique to combustion plants of < 300 MW _{th} . There may be technical and economic restrictions for retrofitting plants operated between 500 h/yr and 1 500 h/yr	Because of the high costs of the wet scrubbing process, this technique is an economic solution for larger plants, depending on the operating regime and on the sulphur content of the fuel. Not viable for plants operated < 500 h/yr	Plants 258, 259
Seawater FGD	The use of a seawater scrubber strongly depends on the specific situation because of the pollution impact on the marine environment. See also Section 3.2.2.2.2	Reduction of SO _x and dust emissions	NA	Tendency to lead to reduced pH levels in the vicinity of the water discharge, and the emission of metals and remaining ash to the marine environment	See technical considerations relevant to applicability for wet FGD		Plant-specific. Not viable for plants operated < 500 h/yr	NA

Spray dry scrubber or absorber (SDA)	See Section 3.2.2.2.6 Spray dry scrubbers first produce dust, and they reduce dust emissions only in combination with effective particulate removal systems (BF, ESP)	Reduction of SO _x emissions	High operational experience.	Residues that need to be landfilled	Generally applicable	Plant-specific	NA
Duct sorbent injection (DSI)	The injection and dispersion of a dry powder sorbent in the flue-gas stream. The sorbent (e.g. sodium bicarbonate, hydrated lime) reacts with acid gases (e.g. the gaseous sulphur species, HCl) to form a solid which is removed by filtration (bag filter or electrostatic precipitator) See also Section 3.2.2.2.8		NA	NA	Generally applicable	NA	Plant 70
Flue-gas condenser	See Section 3.2.3.15				Generally applicable		Plant 454
NB: NA: No relevant specific information available.							

Figure 6.4 shows yearly SO₂ emission concentrations from well-performing HFO- and/or gas-oil-fired plants of < 300 MW_{th}, all using fuel choice as a technique, in one case combined with flue-gas condenser; it is noted as reference that the use of fuel with 0.1 % sulphur content results in SO₂ emissions of 175 mg/Nm³. Figure 6.5 shows yearly SO₂ emission concentrations from well-performing HFO- and/or gas-oil-fired plants of ≥ 300 MW_{th}, all using the wet FGD technique. The plants shown in Figure 6.4 (total rated thermal input ranging between 35 MW and 84 MW) periodically monitor SO₂ emission concentrations and the plants shown in Figure 6.5 (total rated thermal input ranging between 417 MW and 800 MW) continuously monitor SO₂ emission concentrations. There is no evidence of correlation between the SO₂ emission concentrations plotted in Figure 6.4 and plant age (commissioning years between 1967 and 2004), load (equivalent full load factor ranging between 28 % and 80 %) or operating hours (total operating hours ranging between 30 and 219). There is no clear correlation between the SO₂ emission concentrations plotted in Figure 6.5 and plant load (equivalent full load factor ranging between 60 % and 74 %) or operating hours per year (total operating hours ranging between 630 and 5580).

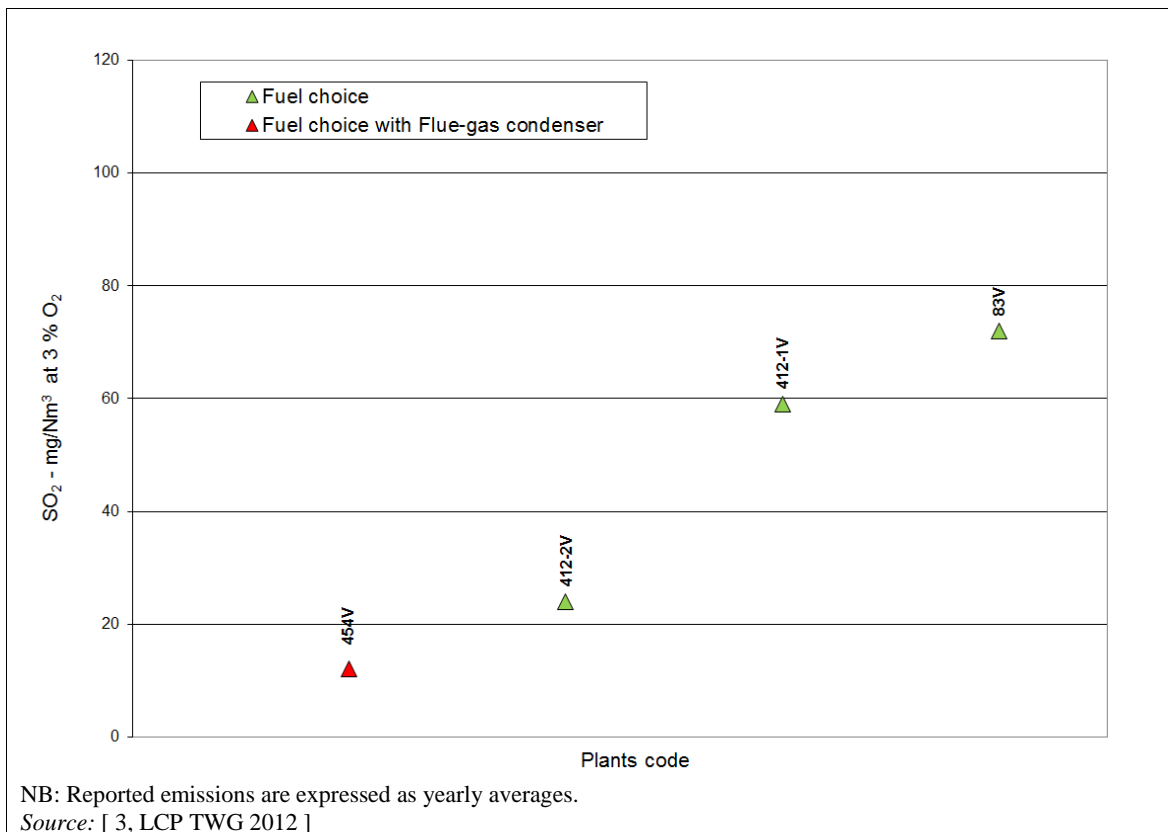

Figure 6.4: SO₂ emissions from well-performing HFO- and/or gas-oil-fired boilers of < 300 MW_{th}

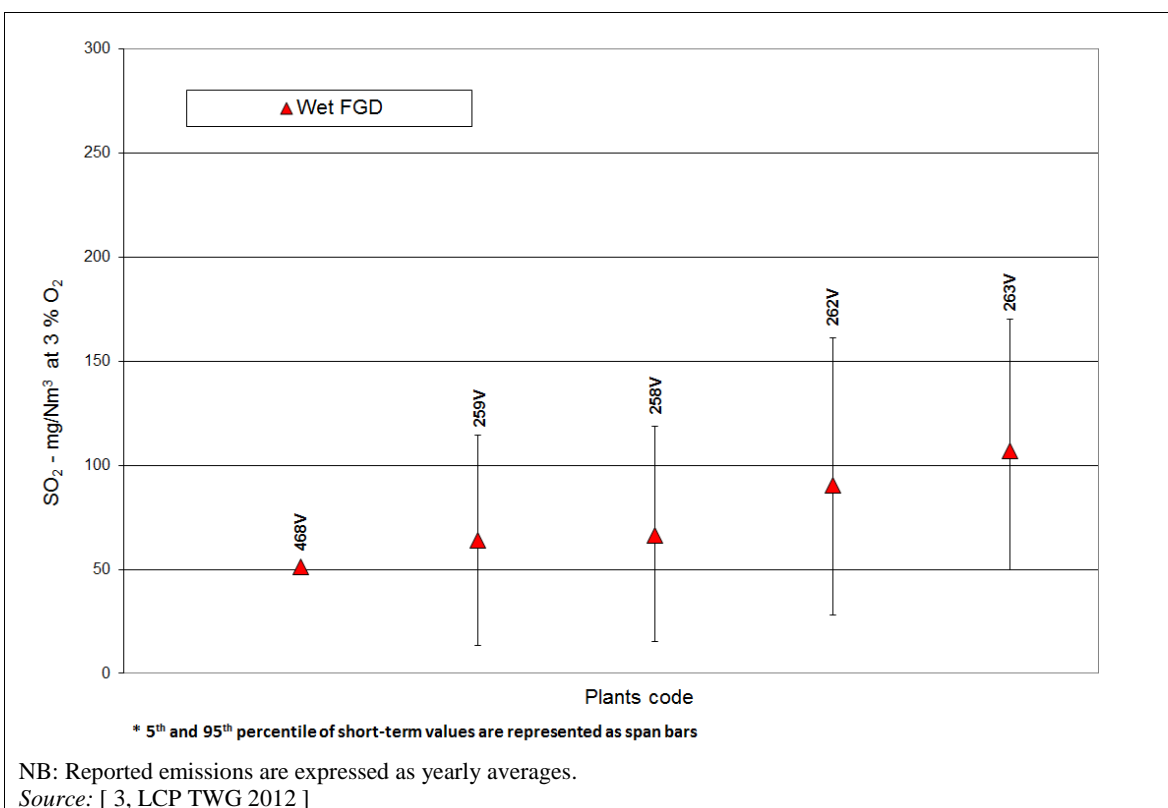

Figure 6.5: SO₂ emissions from well-performing HFO- and/or gas-oil-fired boilers of ≥ 300 MW_{th}

6.3.2.5 Techniques for the prevention and control of dust and particulate-bound metals emissions

Information on general techniques for the prevention and control of dust and particulate-bound metals emissions is given in Section 3.2.2.1. Table 6.10 gives additional information on the same topic specific to HFO and/or gas oil combustion in boilers, e.g. on environmental performances and example plants. Further details on related environmental performance and operational data are provided after the table.

Table 6.10: Techniques for the prevention and control of dust and particulate-bound metals emissions from HFO- and/or gas-oil-fired boilers

Technique	Technical description	Achieved environmental benefits	Environmental performance and operational data	Cross-media effects	Technical considerations relevant to applicability		Example plants
					New plants	Existing plants	
Fuel choice	See Section 3.1.1.4	Reduction of dust emissions	High operational experience	None	Applicable within the constraints associated with the applicability of different types of fuel, which may be impacted by the energy policy of the Member State		NA
Electrostatic precipitator (ESP)	See Section 3.2.2.1.1. ESPs are widely used for boilers.	Reduction of dust and particulate-bound metals emissions			Higher pressure losses compared to ESP > 97 % dust removal efficiency High operational experience	Elevated risk of fire; the risk can be reduced if the bag filter is applied in combination with wet FGD	Generally applicable
Bag filter	See Section 3.2.2.1.2. A sorbent [e.g. Ca(OH) ₂ or NaHCO ₃] may be injected upstream of the filter to dilute the potentially sticky ash/soot that might otherwise cause a high pressure drop over the bags	Reduction of dust emissions, including fine dust (PM _{2.5} and PM ₁₀) and particulate-bound metals	Plant 70				
Multicyclone	Used as a first stage, followed by other more efficient techniques. See also Section 3.2.2.1.3	Reduction of dust	Plant 83				
Desulphurisation techniques	See Section 3.2.2.2. These techniques are mainly used for SO _x control	SO _x reduction with additional reducing effect on dust emissions	NA	NA	See Table 6.9		Plant 259
NB: NA: No relevant specific information available.							

Figure 6.6 shows yearly dust emission concentrations from well-performing HFO- and/or gas-oil-fired plants of < 300 MW_{th}. Plant 290V firing HFO with 0.018 wt-% ash content reports yearly dust emissions below 20 mg/Nm³. shows yearly dust emission concentrations from well-performing HFO-fired plants of ≥ 300 MW_{th}, all using an ESP with or without wet FGD. Plants 154-1 and 154-2 fire gas oil. Several of the plants shown in Figure 6.6 and all of the plants shown in Figure 6.7 continuously monitor dust emission concentrations. There is no evidence of correlation between the dust emission concentrations plotted in Figure 6.6 and plant load (equivalent full load factor ranging between 16 % and 80 %) or operating hours per year (total operating hours ranging between 200 and 7740), and neither between the dust emission concentrations plotted in Figure 6.7 and plant load (equivalent full load factor ranging between 21 % and 74 %) or operating hours per year (total operating hours ranging between 630 and 5 580).

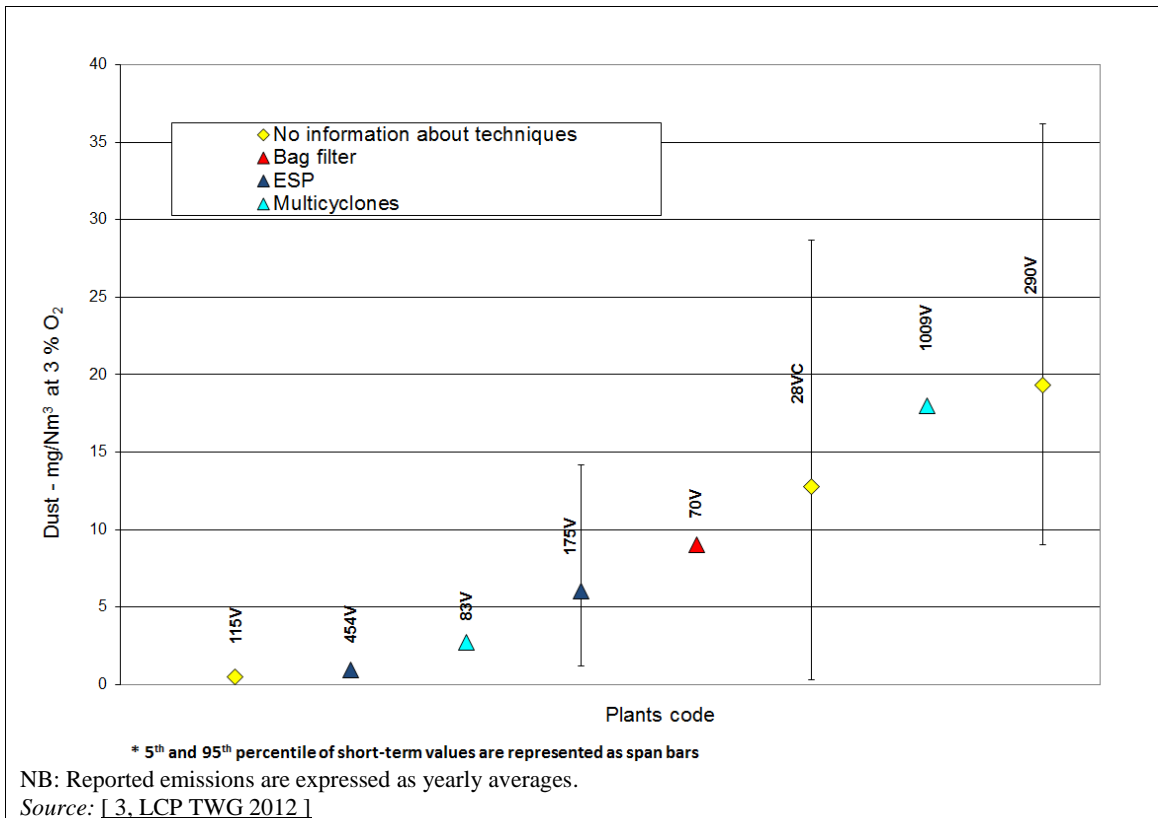

Figure 6.6: Dust emissions from well-performing HFO- and/or gas-oil-fired boilers of < 300 MW_{th}

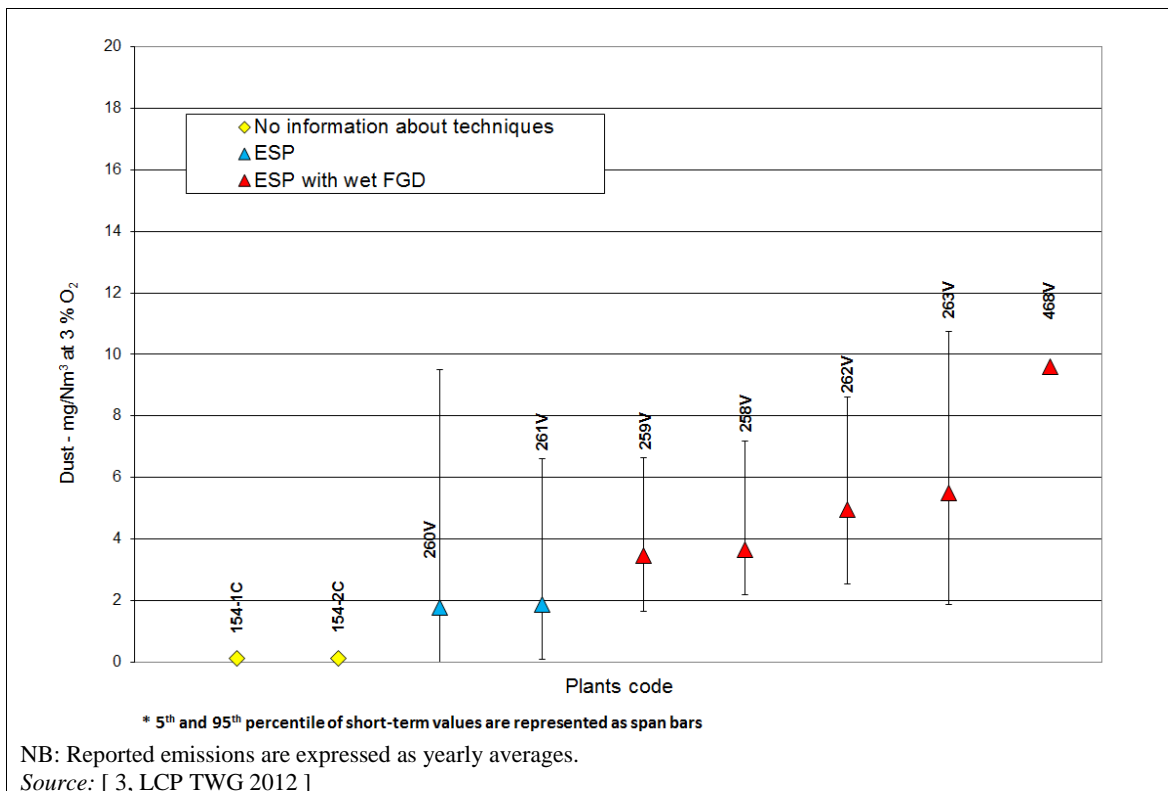

Figure 6.7: Dust emissions from well-performing HFO- and/or gas-oil-fired boilers of $\geq 300 \text{ MW}_{\text{th}}$

6.3.3 Techniques to consider in the determination of BAT for the combustion of HFO and/or gas oil in engines

6.3.3.1 Techniques to increase energy efficiency

Information on general techniques to increase the energy efficiency of combustion plants is given in Section 3.2.3, while Figure 6.10 gives additional information on energy efficiency specific to the combustion of HFO and/or gas oil in engines, e.g. on environmental performances and example plants.

Figure 6.8 shows the operating electrical efficiencies and total fuel utilisation of some European HFO- and/or gas-oil-fired engines, commissioned between 1984 and 2012, operated between 277 h/yr and 8 500 h/yr, with an equivalent full load factor between 54 % and 97 %.

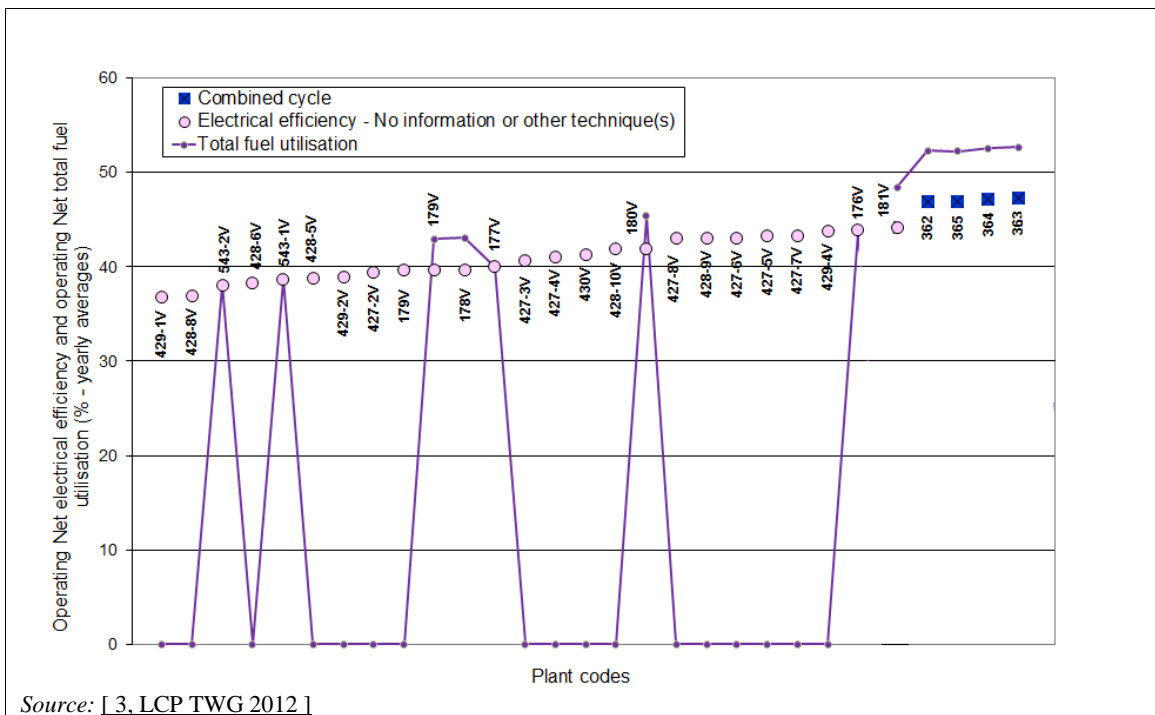

Figure 6.8: Operating energy efficiencies of European HFO- and/or gas-oil-fired combustion engines

The design net electrical efficiency of the single-cycle two-stroke engine unit 181 is 44.5 %. Unit 176 is also a two-stroke engine. Large two-stroke diesel engines are more efficient than large four-stroke engines, which may have design net electrical efficiencies up to 41.5 %.

Four plants with two engines each and a common steam turbine commissioned after 2010 reported design net electrical efficiencies above 48 %. These plants are fitted with a once-through cooling system; there may be an impact on energy efficiency if using a closed system in dry, hot conditions.

[66, TWG Task Force on Energy Efficiency 2014]

Table 6.11: Techniques to increase the efficiency of HFO- and/or gas-oil-fired engines

Technique	Technical description	Achieved environmental benefits	Environmental performance and operational data	Technical considerations relevant to applicability		Example plants	Reference literature
				New plants	Existing plants		
Heat recovery in CHP plants	See Section 3.2.3.2	Increased efficiency		Generally applicable	Very limited applicability		[136, EUROMOT 2001]
Combined cycle	Following the cleaning steps, the engine's exhaust gas, which still contains a considerable amount of energy, is passed through waste heat recovery boilers. Part of the energy in the exhaust gases is transferred to a steam cycle. See also Section 3.2.3.11	Increased efficiency of engine plants	Additional electricity can be produced and the net efficiency of the plant can be increased up to 48 % (increasing the electrical efficiency by more than 5 %) by decreasing the exhaust gas temperature to 170 °C when the plant is operated above 50 % of equivalent full load. The high efficiency results in lower fuel consumption per kWh generated (about 0.19 g of fuel per kWh).	Generally applicable. In the case of heat recovery steam generators with steam turbines the applicability is very limited for existing plants due to space restrictions		Plants 362, 363, 364, 365	NA
Change of turbine blades	Steam turbine blades can be changed to three-dimensional blades during regular maintenance intervals	Increased efficiency	NA	Generally applicable to engines fitted with HRSG in combined cycle mode, where the combustion energy is transferred to a steam cycle. Applicable where steam turbine blades are available for the pressure steam of the turbine		NA	
Advanced control system	See also Section 3.2.3.8	Increased efficiency.	High operational experience	Generally applicable			
Heat accumulation (heat storage)	See Section 3.2.3.9	Increased efficiency	NA	Generally applicable			
NB: NA: No relevant specific information available.							

6.3.3.2 Techniques to prevent and/or control NO_x and CO emissions

Information on general techniques for the prevention and control of NO_x and CO emissions is given in Section 3.2.2.3, while Figure 6.11 gives additional information on the specific case of HFO and/or gas oil combustion in engines, e.g. on environmental performances, economics and example plants. Further details on related environmental performance and operational data are provided after the table.

Table 6.12: Techniques for the prevention and control of NO_x and CO emissions from HFO- and/or gas-oil-fired engines

Technique	Technical description	Achieved environmental benefits	Environmental performance and operational data	Cross-media effects	Technical considerations relevant to applicability		Economics	Example plants	Reference literature
					New plants	Existing plants			
Exhaust gas recirculation	See Section 3.2.2.3.3	Reduction of NO _x emissions	NA	NA	Not applicable to four-stroke engines		Plant-specific	NA	NA
Water/steam addition	See Section 3.2.2.3.10. This can be done by direct injection, by means of an emulsion of fuel and water, or through a mixture of combustion air and steam (humid air)		NO _x emissions range: < 1 300 mg/Nm ³ to 1 600 mg/Nm ³	Increased engine fuel consumption	Applicable within the constraints of water availability. The applicability may be limited in the case of engines where a retrofit package is not available.		NA	NA	
Low-NO _x combustion concept in diesel engines	See Section 3.2.2.3.8. Includes the possibility of early closing of the air inlet valves, which suppresses the in-cylinder temperatures, thus reducing NO _x formation		By using a low-NO _x combustion concept, the NO _x emissions of modern engines are up to 40 % lower than that of a similar engine type from the beginning of the 1990s whilst maintaining the same efficiency	Higher pressure ratios are needed otherwise the fuel consumption increases and the power output of the engines might decrease	Generally applicable		NA	Plant 427-6V	

<p>Selective catalytic reduction (SCR)</p>	<p>It can be retrofitted both in high- and low-dust configurations. See Section 3.2.2.3.11</p>	<p>Reduction of NO_x</p>	<p>Three layers are generally sufficient to achieve 92 % NO_x reduction. SCR catalyst requires regeneration every five years. A control system may be needed in order to ensure correct operation of SCR</p>	<p>Ammonia slip</p>	<p>Generally applicable</p>	<p>There may be technical and economic restrictions for retrofitting plants operated between 500 h/yr and 1 500 h/yr. Retrofitting existing plants may be constrained by the availability of sufficient space.</p>	<p>See information on cost for SCR below this table. Not viable for plants operated < 500 h/yr</p>	<p>Plants 364, 691</p>	<p>[95, UNECE 2012] [164, Rigby et al. 2001] [165, EUROMOT 2002] [166, Ceramics GmbH 2002] [136, EUROMOT 2001]</p>
<p>NB: NA: No relevant specific information available.</p>									

Additional information on technical considerations relevant to SCR applicability

The following issues are important when considering the applicability of SCR:

- The flue-gas temperature is important to avoid salt formation on the catalyst elements. A certain minimum flue-gas temperature, which depends on the sulphur content of the fuel, has to be maintained. Some trace metals which might be present in the fuel can poison the catalyst, and thus the ash content of the fuel to be used may need to be analysed if low-grade heavy fuel oil is utilised. Most diesel plants currently equipped with SCR run on low-sulphur oils or natural gas. Experience has shown that when operating on heavy fuel oil or other residual fuels, a soot blowing system needs to be installed in the SCR reactor, in order to keep the elements clean and avoid pressure drop increases over the SCR.
- Using urea can minimise the transportation and storage risks associated with ammonia. The supply of reagent requires a proper industrial infrastructure.
- The SCR technique has high capital and operating costs. For technical reasons related to ensuring flexibility at low loads, in modular power plants each engine is, in general, equipped with its own SCR unit. The SCR unit may not operate well during start-ups and shutdowns, which affects the reduction of NO_x emissions [96, Malta 2013]. Operating costs depend on the amount of reagent needed and the frequency at which the catalytic elements need to be replaced or newly added to maintain the design efficiency of the SCR (after a few years of operation). The used catalytic elements are regenerated or need to be properly disposed of when regeneration is not possible.
- In some cases, fitting the engine with SCR allows the energy efficiency of the plant to be increased by up to 5 percentage points, by optimising the engine for maximum electrical output. Such tuning will normally lead to increased NO_x formation but this effect can be disregarded when SCR is applied. [97, Jacobsen 2011] [26, Jacobsen 2011]. However, this will have also an impact on the SCR reagent consumption and associated cost. For modern engines already operated at their maximum cylinder output, the benefit on energy efficiency of fitting the plant with an SCR will be much more limited. [98, EUROMOT 2013]
- The SCR system needs regular planned maintenance or inspection, e.g. annually, in order to prevent ammonia slip. For instance, with high ammonia slip, harmful salt deposits can occur on the internal surfaces of the components sited after the reactor, for example on the HRSG in the case of a combined-cycle plant.
- In 2014, there were more than 50 engines in French SIS operating with SCR (e.g. Plant 691 of the data collection 2012). These SCR devices still need optimisation (e.g. in Vazzio, the applicability was complex due to the constraints of space availability). [99, FRANCE 2013] [100, FRANCE 2014]

Economics of SCR

In 2014, the typical cost of NO_x removal with the use of SCR in HFO diesel engines located on isolated islands was estimated at EUR 1450/t of NO_x abated (additional cost of the electricity produced of EUR 17.4/MWhe; it is about a cost increase of 24.8 %). In HFO diesel engines located on the mainland the typical cost was estimated at EUR 675/t of NO_x abated (additional cost of the electricity produced of EUR 8.1/MWhe; it is about a cost increase of 11.5 %).

[101, Eurelectric 2014]

Typical costs of SCR as a function of NO_x reduction are shown in Figure 6.9, where the following cost pattern is used: urea 40 % solution: 200 EUR/t; urea granulate: 400 EUR/t; aqueous 25 % ammonia solution: 225 EUR/t. The cost and availability of reagents might vary from location to location; according to recent information, the current (2014) price of urea for mainland application is about EUR 450/t.

According to Greek operators, in a 2009 contract for seven medium-speed HFO diesel engines (16.5 MW_e each) to be constructed in one MIS, the installed cost of the SCR (not including the

urea-handling system) was about EUR 91/kWe. Based on these assumptions, the cost of NO_x removal with the use of SCR in HFO diesel engines located on isolated islands was estimated at EUR 2000/t of NO_x abated. [101, Eurelectric 2014]

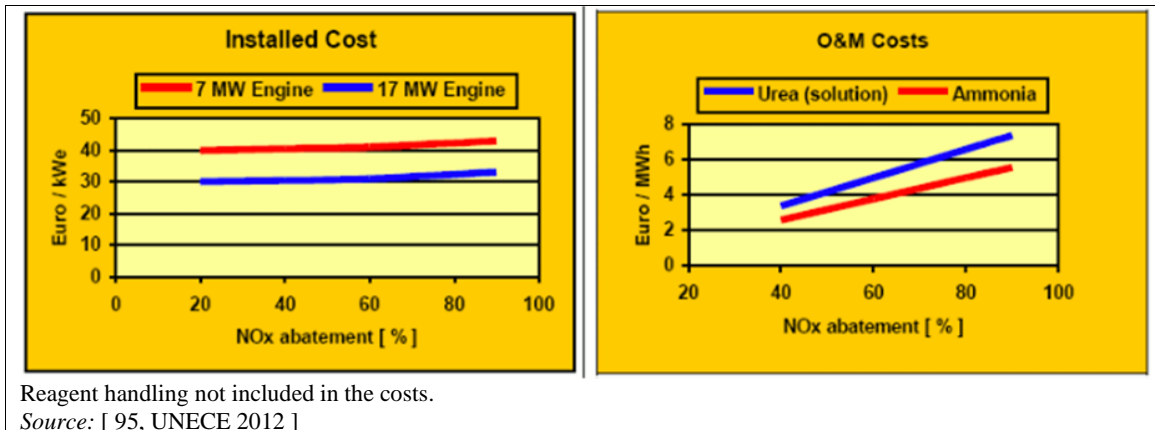

Figure 6.9: Typical costs of SCR as a function of the NO_x reduction rate at a HFO-fired medium-speed diesel engine power plant

Environmental performance and operational data

Figure 6.10 shows NO_x emission concentrations from engine plants operated between 64 and 7 500 hours per year load with equivalent full load factor between 53 % and 115 %. Most of them continuously monitor NO_x emission concentrations. No evidence of correlation between the plotted NO_x emission concentrations and plant size (total rated thermal input spanning the range 15–515 MW, as the engine plants are usually modular) or plant age (commissioning years between 1987 and 2012) is observed. All except one of the plotted plants reported yearly average CO emissions concentrations below 175 mg/Nm³. The yearly average NH₃ emissions concentrations for the plotted plants are below 9 mg/Nm³.

Plants 364V, 362V, 365V and 363V reported yearly average and short-term average NO_x emissions below 225 mg/Nm³ using urea as a reagent; Plant 691 reported yearly average emissions slightly above this level and the emissions reported by Plant 429-4 are influenced by testing periods and breakdowns. All these plants are fitted with SCR. For other plants fitted only with primary techniques or no technique at all, with NO_x emission levels as high as 2 500 mg/Nm³, the use of SCR could deliver a reduction in NO_x emissions of at least 75 %.

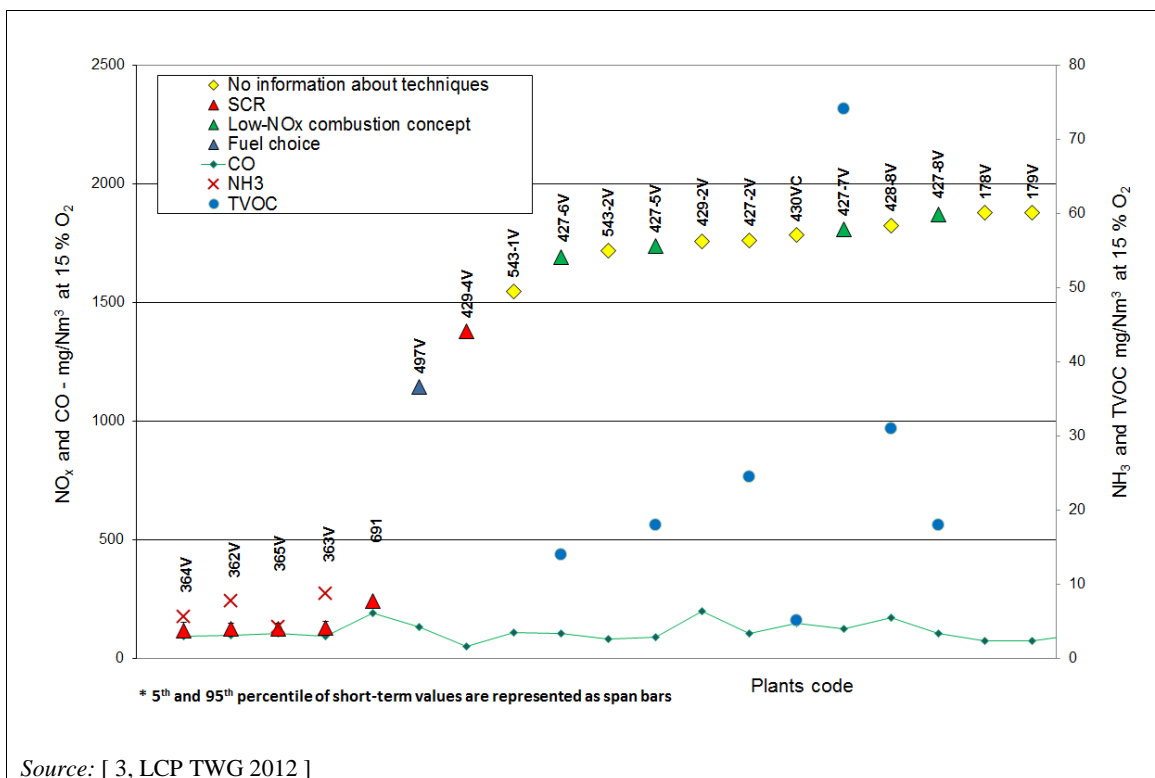

Figure 6.10: Yearly NO_x, NH₃, TVOC and CO emissions from HFO- and/or gas-oil-fired engines fitted with SCR and/or primary techniques

6.3.3.3 Techniques to prevent and/or control SO_x emissions

Information on general techniques for the prevention and control of SO_x emissions is given in Section 3.2.2.2. Table 6.13 gives additional information on the techniques specific to the combustion of HFO and/or gas oil in engines, e.g. on environmental performances and example plants. Further details on related environmental performance and operational data are provided after the table.

Table 6.13: Techniques for the prevention and control of SO_x emissions from HFO- and/or gas-oil-fired engines

Technique	Technical description	Achieved environmental benefits	Cross-media effects	Technical considerations relevant to applicability		Economics	Example plants
				New plants	Existing plants		
Fuel choice	See Section 3.1.1.4	Reduction of SO _x emissions at source	NA	Applicable within the constraints associated with the availability of different types of fuel, which may be impacted by the energy policy of the Member State		NA	NA
Seawater FGD	The use of a seawater scrubber strongly depends on the specific situation because of the pollution impact on the marine environment. See also Section 3.2.2.2.2	Reduction of SO _x	Tendency to lead to reduced pH levels in the vicinity of the water discharge, and the emission of metals and remaining ash to the marine environment	See technical considerations relevant to applicability for wet FGD		Plant-specific	NA
Wet flue-gas desulphurisation (Wet FGD)	See Section 3.2.2.2.1.	Reduction of SO _x emissions	NA	There may be technical and economic restrictions for applying the technique to combustion plants of < 300 MW _{th} . Not applicable to combustion plants operated < 500 h/yr		Not viable for combustion plants operated < 500 h/yr	SANKO Holding, Gaziantep, Turkey
				There may be technical and economic restrictions for retrofitting existing combustion plants operated between 500 h/yr and 1 500 h/yr			
Spray dry scrubber or absorber (SDA)	See Section 3.2.2.2.6. Spray dry scrubbers initially produce dust. They reduce dust emissions only in combination with effective particulate removal systems (BF, ESP)	Reduction of SO _x emissions	Residues that need to be landfilled or recycled where possible	Not applicable to combustion plants operated < 500 h/yr		NA	NA

Duct sorbent injection (DSI)	The injection and dispersion of a dry powder sorbent in the flue-gas stream. The sorbent (e.g. sodium bicarbonate, hydrated lime) reacts with acid gases (e.g. the gaseous sulphur species, HCl) to form a solid which is removed by filtration (bag filter or electrostatic precipitator). See also Section 3.2.2.2.8	Reduction of SO _x emissions	NA	Not applicable to combustion plants operated < 500 h/yr		NA	Plants 362, 363
					There may be technical restrictions in the case of existing combustion plants		
NB: NA: No relevant specific information available.							

Figure 6.11 shows SO₂ emission concentrations from well-performing engine plants. The engine plants using DSI shown in Figure 6.11 continuously monitor SO_x emission concentrations (SO₂ is continuously measured, SO₃ is periodically measured, e.g. during calibration, and the SO₂ to SO₃ ratio is periodically adjusted). Plant 428-6V was commissioned in 1997 and reported an equivalent full load factor of 69 % and 5 800 operating hours in 2010. It monitors SO₂ emissions continuously. Plant 430 (three engines of 24 MW_{th} each) was commissioned in 2000 and reported an equivalent full load factor of 74 % and 8 700 operating hours in 2010. It monitors SO₂ emissions periodically (four times per year). Plants 362 to 365 were commissioned in 2012 (two engines of 38.5 MW_{th} at each plant) and report similar load and operating hours per year, 93 % and about 6 000 hours. For reference, if no secondary abatement technique is applied, a fuel sulphur content of 0.5 % corresponds to SO₂ emissions of 280 mg/Nm³.

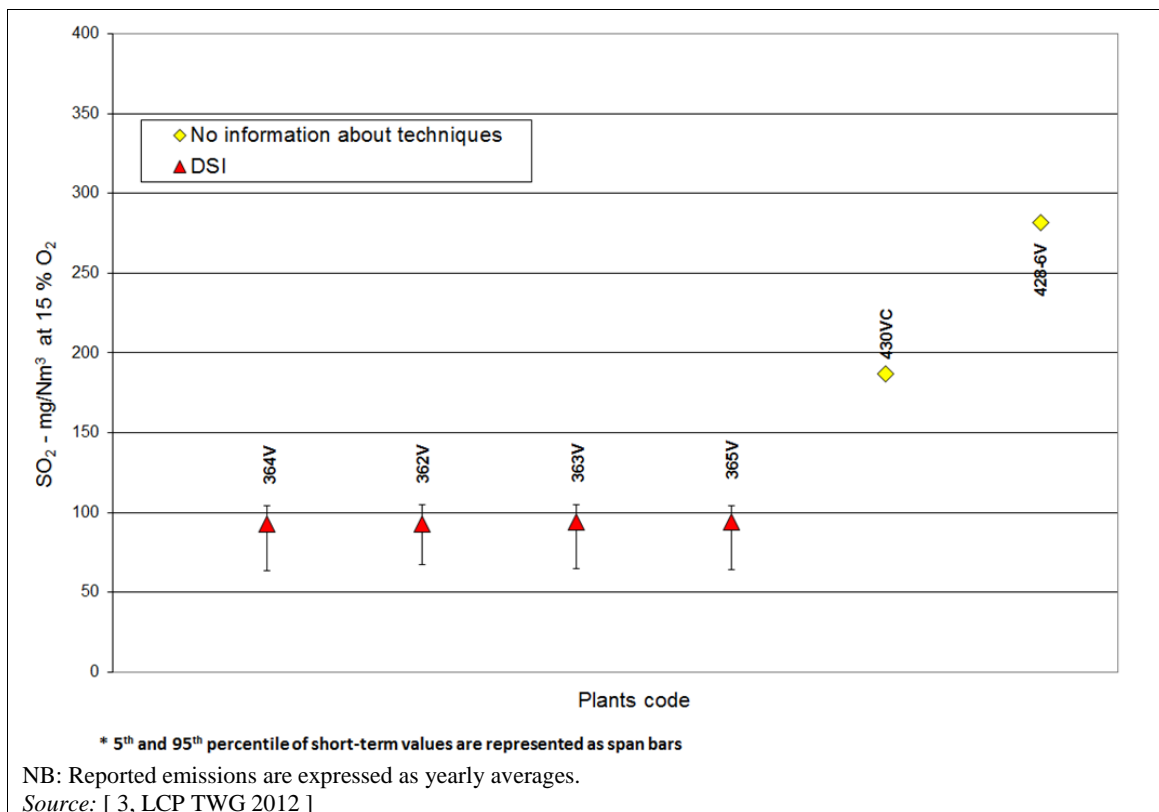

Figure 6.11: SO₂ emissions from HFO- and/or gas-oil-fired engines reporting emission levels below 280 mg/Nm³

6.3.3.4 Techniques to prevent and control dust and particulate-bound metals emissions

Information on general techniques for the prevention and control of dust and particulate-bound metals emissions is given in Section 3.2.2.1. Table 6.14 gives additional information on the same topic specific to HFO and/or gas oil combustion in engines, e.g. on environmental performances and example plants. Further details on related environmental performance and operational data are provided after the table.

Table 6.14: Techniques for the prevention and control of dust and particulate-bound metals emissions from HFO- and/or gas-oil-fired engines

Technique	Technical description	Achieved environmental benefits	Environmental performance and operational data	Cross-media effects	Technical considerations relevant to applicability		Example plants
					New plants	Existing plants	
Fuel choice	See Section 3.1.1.4	Reduction of dust emissions	NA	None	Applicable within the constraints associated with the applicability of different types of fuel, which may be impacted by the energy policy of the Member State		NA
Electrostatic precipitator (ESP)	See Section 3.2.2.1.1	Reduction of dust and particulate-bound metals emissions	Very few examples of applications provided	None			NA
Bag filter	See Section 3.2.2.1.2	Reduction of dust emissions, particularly fine dust (PM _{2.5} and PM ₁₀) and particulate-bound metals	Higher pressure losses compared to ESP. > 97 % dust removal efficiency obtained by using glass fibre with a PTFE membrane and PTFE thread	Elevated risk of fire; the risk can be reduced if the bag filter is applied in combination with wet FGD	Not applicable to combustion plants operated < 500 h/yr		Plants 362, 363
NB: NA: No relevant specific information available.							

Figure 6.12 shows dust emission concentrations from well-performing engine plants operated between 277 and 8 700 hours per year at equivalent full load factor between 58 % and 115 %. Most of them continuously monitor dust emission concentrations. No evidence of correlation is observed between the plotted dust emission concentrations and plant size (total rated thermal input spanning the range 15–515 MW, as engine plants are usually modular) or plant age (commissioning years between 1992 and 2012). Plants using bag filters to abate dust are also fitted with DSI to abate SO₂ emissions. Plant 543-2 uses 60 % gas oil and 40 % HFO.

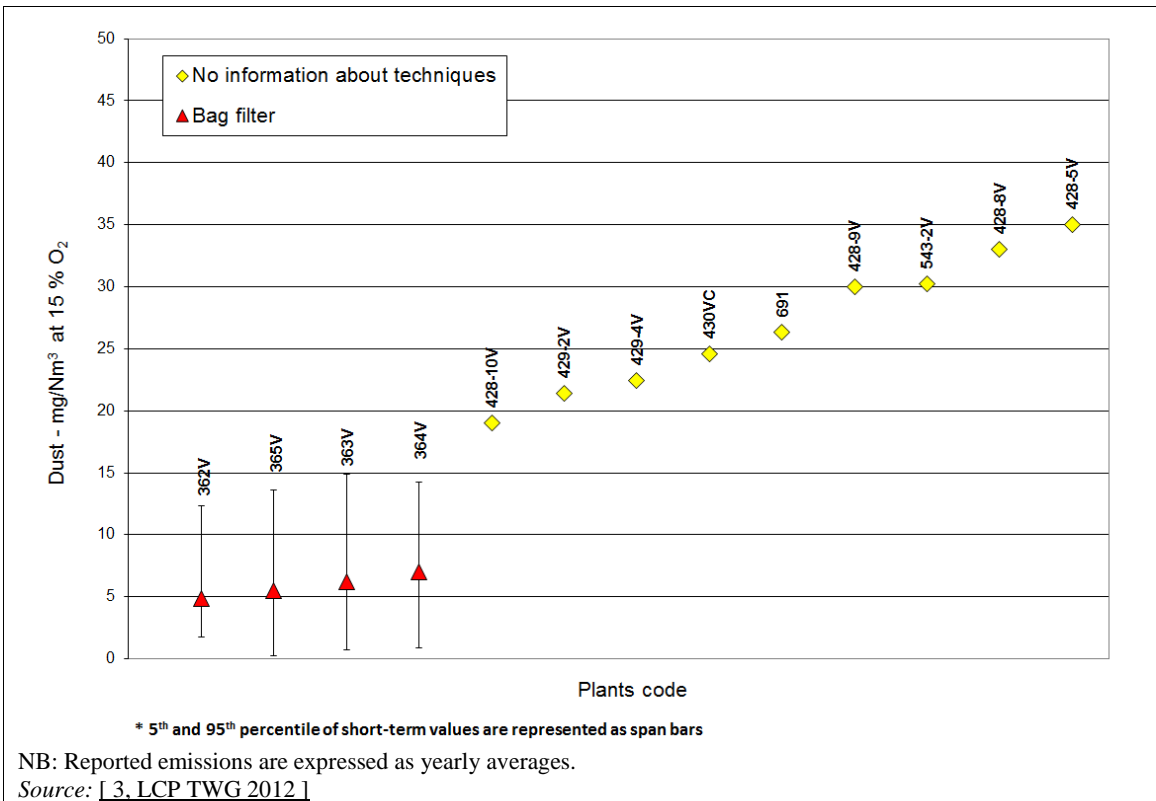

Figure 6.12: Dust emissions from well-performing HFO- and/or gas-oil-fired engines

The configuration of abatement techniques of Plants 362, 365, 364 and 365 using bag filters for dust, DSI for SO₂ and SCR for NO_x reduction is shown in Table 6.14

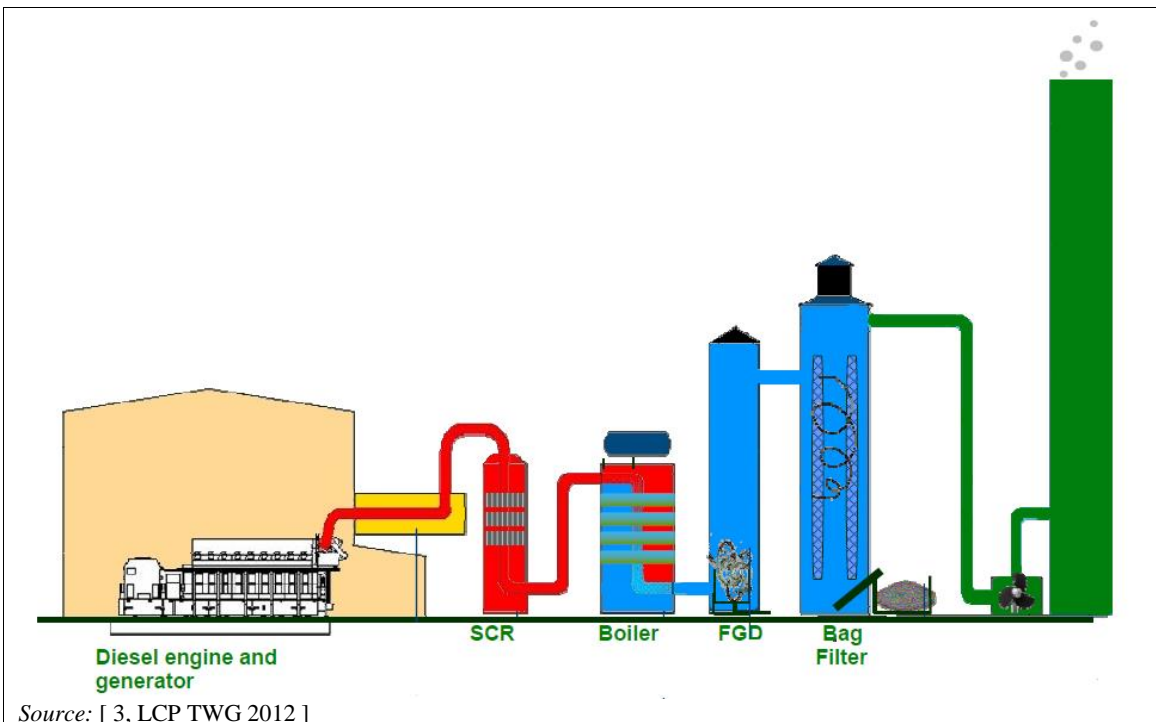

Figure 6.13: Configuration of an engine combustion plant fitted with SCR, recovery boiler, DSI and a bag filter

6.3.4 Techniques to consider in the determination of BAT for the combustion of gas oil in gas turbines

6.3.4.1 Techniques to increase energy efficiency

Information on general techniques to increase the energy efficiency of combustion plants is given in Section 3.2.3. gives additional information on energy efficiency specific to the combustion of gas oil in gas turbines, e.g. on environmental performances and example plants.

Figure 6.14 shows the operating net electrical efficiencies and total fuel utilisation of example European gas-oil-fired gas turbines, commissioned between 1974 and 2008, operated between 5 h/yr and 8 200 h/yr, with an equivalent full load factor between 61 % and 97 %.

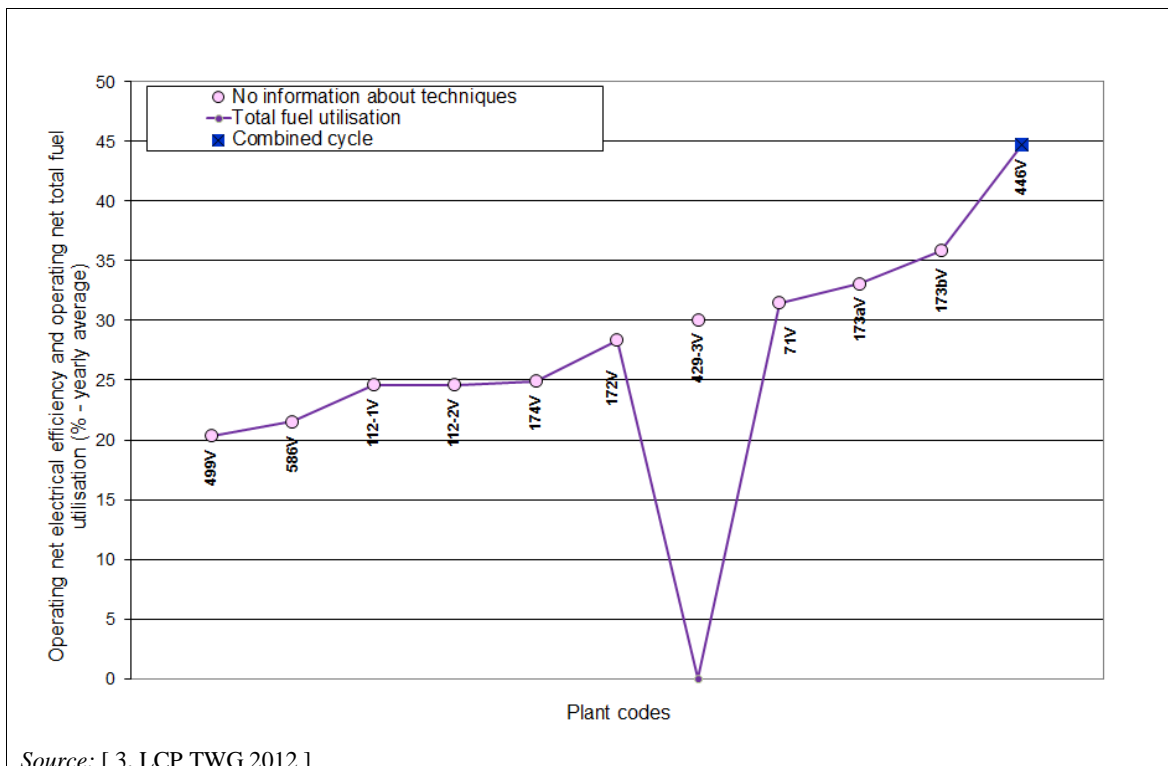

Figure 6.14: Operating energy efficiencies of European gas-oil-fired gas turbines

The design net electrical efficiencies reported by three open-cycle gas turbines commissioned before 2010 are up to 35.7 %. The design value for net electrical efficiency reported by one combined-cycle gas turbine commissioned before 2010 is 44 %.

[66, TWG Task Force on Energy Efficiency 2014]

Table 6.15: Techniques to increase the energy efficiency of gas-oil-fired gas turbines

Technique	Technical description	Achieved environmental benefits	Cross-media effects	Technical considerations relevant to applicability		Example plants
				New plants	Existing plants	
Cogeneration of heat and power (CHP)	See Section 3.2.3.2	Increased energy efficiency	NA	Generally applicable	Very limited applicability	NA
Advanced control system	See Section 3.2.3.8		None	Generally applicable		
Combined cycle	See Section 3.2.3.11		NA	Generally applicable to new combustion units-operated $\geq 1\,500$ h/yr	Applicable to existing turbines within the constraints associated with the steam cycle design and the space availability. Not applicable to existing turbines operated $< 1\,500$ h/yr	Plant 446
NB: NA: No relevant specific information available.						

6.3.4.2 Techniques to prevent and/or control NO_x and CO emissions

Information on general techniques for the prevention and control of NO_x and CO emissions is given in Section 3.2.2.3. Table 6.16 gives additional information on the specific case of gas oil combustion in gas turbines, e.g. on environmental performances and example plants.

Table 6.16: Techniques for the prevention and control of NO_x and CO emissions from gas-oil-fired turbines

Technique	Technical description	Achieved environmental benefits	Environmental performance and operational data	Cross-media effects	Technical considerations relevant to applicability		Example plants	Reference literature
					New plants	Existing plants		
Primary techniques								
Water/steam addition	See Section 3.2.2.3.10		The technique is being fine-tuned in some plants in Spain to achieve NO _x levels below 90 mg/Nm ³ (data at 15 % O ₂). Also, dual fuel GTs are able to meet similar levels when running on gas oil	High consumption of demineralised water. Reduction of electrical efficiency		Applicable within the constraints of water availability	Plants 446, 174	NA
Low-NO _x burner (LNB) in gas oil GT	The fuel is injected through the fuel lance into the burner flow field. Directly upstream of the fuel lance the liquid fuel is mixed with demineralised water to maintain low combustion dynamics and reduce emissions.	Reduction of NO _x	Trials in commercial operation reported NO _x levels below 90 mg/Nm ³ (data at 15 % O ₂)	NA		Only applicable to turbine models for which low-NO _x burners are available on the market	Alstom, Berlin - Mitte	[102, ETN 2013] [201, Alstom 2012] [226, Zajadatz et al. 2012]
Secondary techniques								
Selective catalytic reduction (SCR)	See Section 3.2.2.3.11. Some liquid-fuel-fired gas turbine combined-cycle plants in Europe, particularly in Austria, France, Germany, Italy and the Netherlands, have also applied SCR to reduce NO _x emissions. As a back-up fuel, gas oil is used for a limited time period in dual fuel GTs. In the US, SCR is commonly used for gas turbines, including those operated with liquid fuels.	Reduction of NO _x	NA	Ammonia slip Slight loss of energy efficiency due to pressure drop		Catalysts may be deactivated at low temperatures by high sulphur and ash content, depending on the fuel oil quality	Shoreham plant in New York, 46 MW _{th}). [103, NY Env 2010]	[185, UK 2013] [164, Rigby et al. 2001] [167, Austrian Ministry of Environment 2000]
NB: NA: No relevant specific information available.								

6.3.4.3 Techniques to prevent and/or control SO_x emissions

Information on general techniques for the prevention and control of SO_x emissions is given in Section 3.2.2.2. Table 6.17 gives additional information on the techniques specific to the combustion of gas oil in gas turbines, e.g. on example plants.

Table 6.17: Techniques for the prevention and control of SO_x emissions from gas-oil-fired gas turbines

Technique	Technical description	Achieved environmental benefits	Technical considerations relevant to applicability		Economics	Example plants
			New plants	Existing plants		
Fuel choice	See Section 3.1.1.4	Reduction of SO _x emissions at source	Applicable within the constraints associated with the availability of different types of fuel, which may be impacted by the energy policy of the Member State		The cost of the technique depends on the type and quality of gas oil	Plants 172, 173a

Figure 6.15 shows well-performing gas turbine plants. They periodically monitor SO_x emission concentrations (only Plant 446V continuously monitors SO₂). No evidence of correlation between the plotted SO₂ emission concentrations and plant size (total rated thermal input spanning the range 40–545 MW), plant age (commissioning years between 1974 and 2008), load (equivalent full load factor between 62 % and 88 %) or operating hours per year (total operating hours ranging between 100 and 8 000) is observed. There is however direct correlation with the amount of sulphur contained in the fuel used, as no abatement techniques are used. Plants 172, 173a and 173b fire gas oil with a sulphur content of 0.001 wt-% and Plant 446 reports 35 mg/Nm³ when burning gas oil with a sulphur content of around 0.08 wt-%. The use of gas oil with a higher sulphur content (0.10 wt-%) would mean SO₂ emissions of up to 60 mg/Nm³.

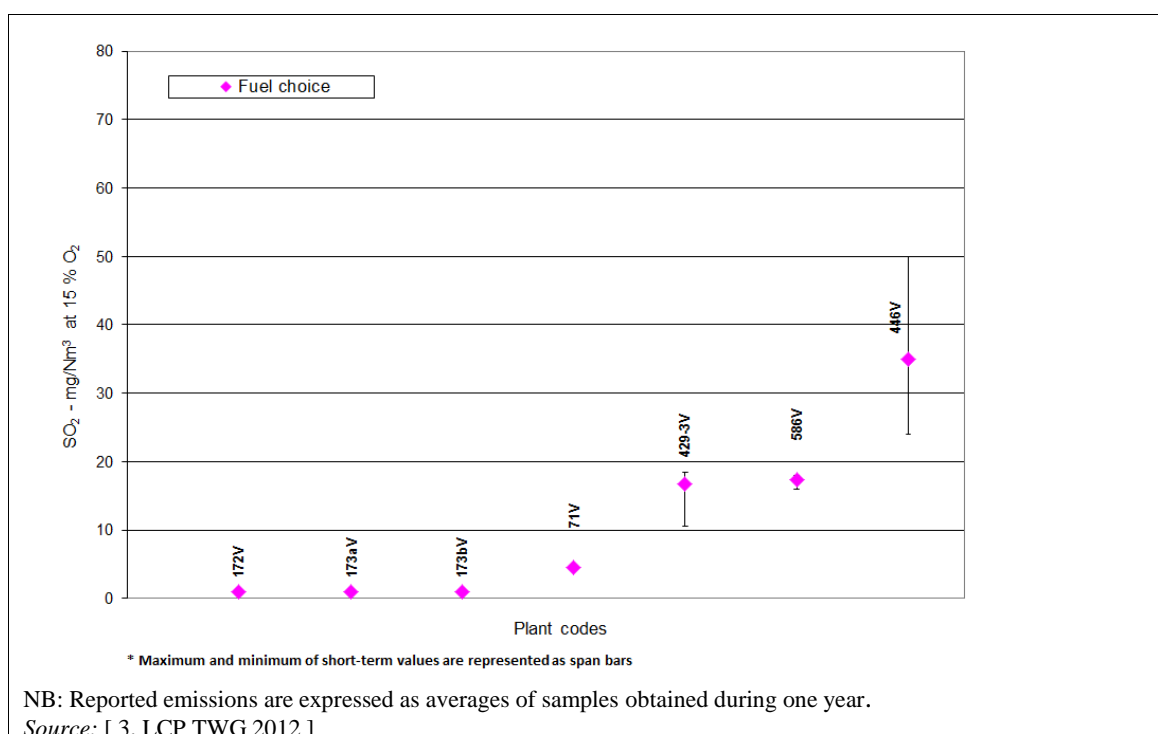

Figure 6.15: SO₂ emissions from well-performing gas-oil-fired gas turbines

6.3.4.4 Techniques to prevent and/or control dust and particulate-bound metals emissions

Information on general techniques for the prevention and control of dust and particulate-bound metals emissions is given in Section 3.2.2.1. Table 6.18 gives additional information specific to gas oil combustion in gas turbines, e.g. on example plants.

Table 6.18: Techniques for the prevention and control of dust and particulate-bound metal emissions from gas-oil-fired gas turbines

Technique (Description)	Technical description	Achieved environmental benefits	Cross-media effects	Technical considerations relevant to applicability		Example plants
				New plants	Existing plants	
Fuel choice	See Section 3.1.1.4	Reduction of dust emissions	None	Applicable within the constraints associated with the applicability of different types of fuel, which may be impacted by the energy policy of the Member State		Plants 71, 446

Figure 6.16 shows well-performing gas turbine plants. They periodically monitor dust emission concentrations (only Plant 446V continuously monitors dust). No evidence of correlation is observed between the plotted dust emission concentrations and plant size (total rated thermal input spanning the range 40–600 MW), plant age (commissioning years between 1974 and 2008), load (equivalent full load factor between 62 % and 88 %) or operating hours per year (total operating hours ranging between 100 and 8 000).

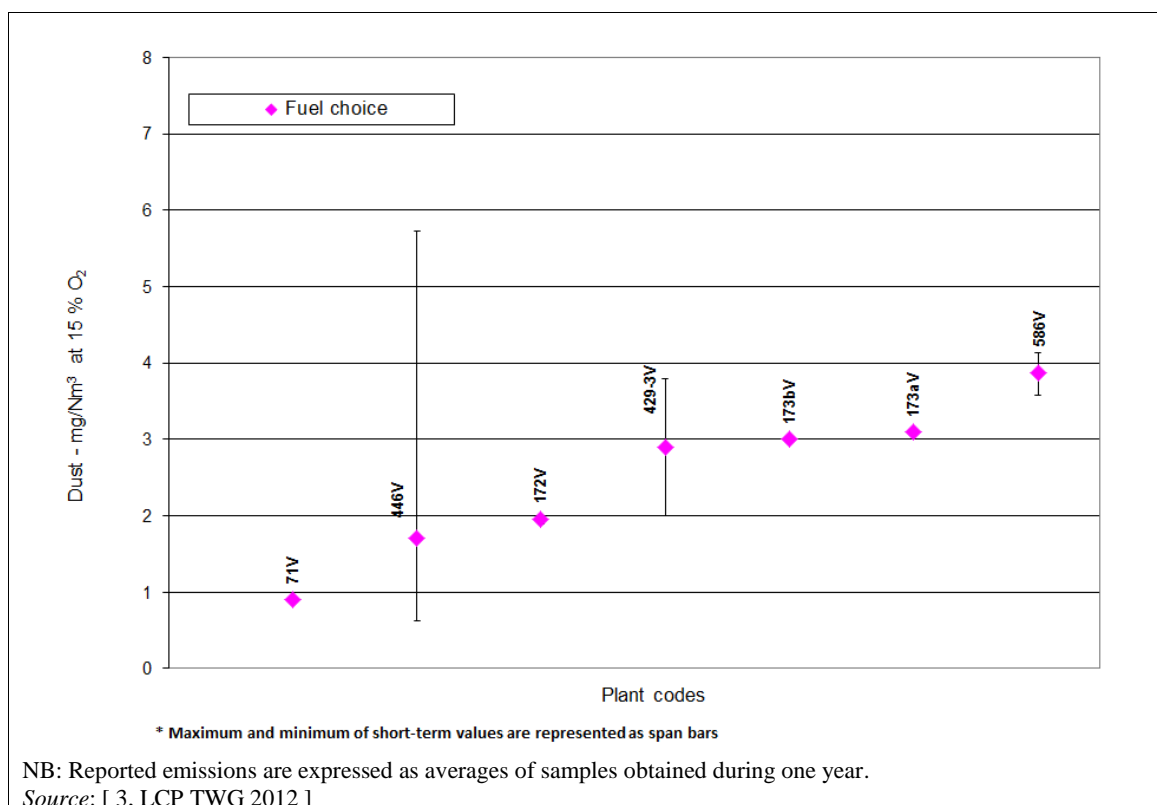

Figure 6.16: Dust emissions from well-performing gas-oil-fired gas turbines

7 COMBUSTION OF GASEOUS FUELS

This chapter addresses the combustion of natural gas, biogas, iron and steel process gases and crude natural gas on offshore platforms.

7.1 Combustion of natural gas

This section first briefly describes the combustion processes applied for natural gas and the techniques used for preventing and/or reducing consumption for and emissions from such processes. Then it presents typical consumption and emission levels at natural-gas-fired plants, before describing in more detail the candidates for best available techniques. Information applying to several combustion processes and types of fuel combustion can be found in Chapters 2 and 3. For instance, general information on the unloading, storage and handling of natural gas can be found in Section 2.8. Information specific to combustion plants burning crude natural gas on offshore platforms is given in Section 7.4

7.1.1 Applied processes and techniques

This section includes specific features on natural gas combustion. Sections 2.2.2, 2.3.2 and 2.3.3 provide general information on combustion processes firing gaseous fuels, such as gas turbines, gas engines and gas boilers. Section 3.1 provides information on generally applied techniques in combustion plants. Section 3.2 describes candidate BAT applying to more than one combustion process or type of fuel firing.

Gas turbines

See description in Section 2.3.3. In addition to the gas turbines described in that section, this chapter also addresses dual fuel gas turbines. The requirement to operate in dual fuel mode further complicates burner design and modification. Where liquid fuels are fired in DLN machines, the fuel is, in effect, sprayed into the combustor and burns in a diffusion flame. Steam or water injection is then typically used for NO_x abatement. For new modern dual fuel systems, the performance when firing natural gas is broadly comparable to the performance of a natural-gas-only system.

Gas-fired boilers

In order to efficiently convert the energy from the steam to electricity, modern gas-fired boilers use supercritical steam (pressure above 220.6 bar and temperature above 374 °C). Plant electrical efficiencies of up to 48 % in the condensing mode and fuel utilisation of up to 95 % in combined heat and power production can be achieved when applying double reheat and an increase in the supercritical steam parameters to 290 bar and 580 °C in power plants.

Gas-fired boilers are commonly used in process industries and in district heating systems. Most of them have a thermal input ranging between 50 MW and 300 MW. For combustion plants in this size range, increasing constraints on SO₂ and NO_x emissions have represented an incentive towards greater utilisation of natural gas. Many of these boilers could also be fed with liquid fuel in emergency situations and are operated in multi-fuel-firing mode. Larger (> 300 MW_{th}) gas-fired boilers generating only electricity that are also in operation. These gas-fired power plants are usually operated less than 1 500 h/yr and some of them are operated in conjunction with a gas turbine, where the flue-gas from the gas turbine is used by the steam generator as combustion air (see also Section 2.4.5 concerning 'combi-plants').

The burners of the boilers are generally arranged over several levels in the walls (front firing or opposed firing) or are positioned tangentially on several levels in the four corners of the boiler. They can also be floor-mounted. Firing systems for gas-fired boilers are similar to coal- or oil-fired boilers.

Gaseous fuels are also used as support or start-up fuel for coal-, lignite-, biomass- and oil-fired boilers.

Gas-fired combustion engines

(See description in Section 2.3.2, and lean-burn concept in Section 3.2.2.3.9.)

Low-pressure gas dual fuel (DF-type) engines and spark-ignited (pure) gas (SG-type) engines are different engine types and their emission performances therefore differ. The flame front is less developed in SG-type engines (no pilot injection) compared to DF-type engines (injection of pilot liquid fuel). Stationary diesel engines can also be operated on natural gas; these are high-pressure gas (GD-type) engines.

7.1.1.1 Fuel characterisation

Table 7.1 and Figure 7.1 give an overview of the relevant properties of natural gas fired in large combustion plants in Europe and several countries worldwide.

Table 7.1: Typical characteristics of NG fired in large combustion plants in Europe

Concentration in natural gas (mol %)	Substance						
	N ₂	CO ₂	CH ₄ – C ₄ H ₁₀	CO	H ₂	Sulphur (H ₂ S)	Dust
0–14	0–3	80–99	0	< 0.1	< 0.0007	0–1 ⁽¹⁾	

⁽¹⁾ Expressed as mg/Nm³
 Source: [123, Eurelectric 2001] [159, Marcogaz 2012] [3, LCP TWG 2012]

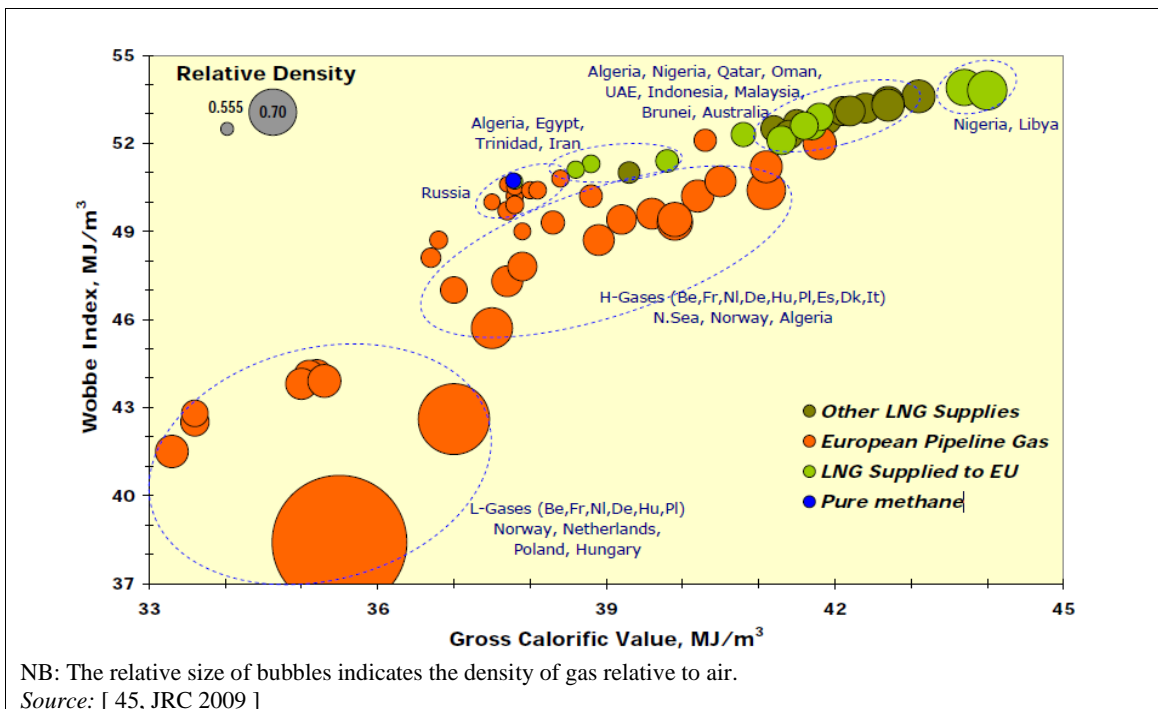

Figure 7.1: Physical properties of European and worldwide pipeline gas and LNG

The ongoing process of creating an internal market for natural gas in the EU is aiming for a harmonisation of the gas standards across the EU, thus reducing technical barriers to gas

imports from third countries. Gas specifications may face variations in the near future, which might affect the performance (emissions, efficiency, etc.) of combustion plants compared with those reported in this document.

7.1.1.2 Control of emissions to air

The emissions from the combustion of natural gas are principally NO_x and CO , with mostly negligible SO_x and dust emission. CO_2 emissions from natural gas combustion are also inherently substantially lower than from other fossil fuels.

Dust emissions

Fuel dust contained in natural gas is washed out at the production site, if necessary. Dust or particulate matter emissions from combustion plants burning natural gas are not an environmental concern under normal operation and controlled combustion conditions.

SO_x emissions

Fuel sulphur in natural gas in the form of H_2S is washed out at the production site. Thus, SO_x emissions from combustion plants burning natural gas are not an environmental concern under normal operation and controlled combustion conditions. However, whilst SO_2 emissions are not environmentally significant, a small portion of the SO_2 can oxidise to SO_3 , a reaction enhanced where catalyst is present, resulting in fouling and corrosion of downstream surfaces.

7.1.1.2.1 Control of NO_x emissions to air from boilers

Boilers and firing systems are, in general, designed for low- NO_x firing. Basically, there are three main ways to reduce thermal NO_x emissions:

- Application of low- NO_x burners. The conditions for low NO_x emissions are a low temperature in the primary combustion zone and a sufficiently long residence time of the flue-gases in the furnace for a complete burnout. This reduces the flame temperature.
- Flue-gas recirculation. It reduces both the flame temperature and the concentration of oxygen.
- Two-stage combustion. This reduces the reaction between oxygen and nitrogen in the air during the combustion process. Substantially lower NO_x emissions can be achieved by supplying the air at three stages around the individual burner, and supplementing the air above the individual burners, together with a precise dosing of these air streams.

Additionally, De NO_x end-of-pipe techniques such as SNCR or SCR can also be applied if the boiler design does not allow primary techniques alone to sufficiently lower NO_x emissions, or when very stringent emission levels have to be met.

7.1.1.2.2 Control of NO_x emissions to air from engines

The most important parameter governing the rate of NO_x formation in internal combustion engines is the combustion temperature; the higher the temperature, the higher the NO_x content of the exhaust gases. One method to reduce the combustion temperature is to lower the fuel to air ratio. The same specific heat quantity released by the combustion of the fuel is then used to heat up a larger mass of exhaust gases, resulting in a lower maximum combustion temperature. This primary technique, called lean-burn concept in gas-fired reciprocating engines, is analogous to dry low- NO_x combustors in gas turbines.

The combustion temperature can also be controlled to some extent in gas-fired reciprocating engines by one or more of the following techniques (many of these are not yet commercially

available, being in the development stage with ongoing laboratory tests; some of the main difficulties encountered in the development of these techniques are also mentioned):

- Delaying combustion by retarding ignition or fuel injection, but with a lower engine efficiency as a cross-media effect.
- Diluting the fuel-air mixture with exhaust gas recirculation (EGR), which replaces some of the air and contains water vapour that has a relatively high heat capacity and which absorbs some of the heat of combustion. The use of this technique may however cause clogging problems.
- Reducing the inlet air temperature with a heat exchanger after the turbocharger or via inlet air humidification.
- Modifying the valve timing, compression ratio, turbocharging, and the combustion chamber configuration, this primarily being an option to increase the efficiency and power output of the gas engine.
- Implementing a process control system.

In some applications (e.g. larger plants in sensitive areas in the US), gas engines have been equipped with SCR for additional NO_x reduction. In the Netherlands, the NO_x emission of hundreds of medium gas engine plants (such as CHP production and CO₂ fertilisation in a greenhouse, with different business models and economic profiles compared to power generation) of more than 2.5 MW_{th} are abated using SCR.

In the case of SCR, a urea solution is generally the reduction agent of choice for SCR systems applied to engines. For applications with variable loads, the engine emissions are measured at different load levels during commissioning. The measured emission values are then entered into the control system, which ensures that the reduction agent is injected into the exhaust gas stream in the correct quantities for the varying NO_x levels. The catalyst type and the SCR reactor size are tailored to the pressure drop constraints of each particular application, so that the engine performance is not affected [164, Rigby et al. 2001]. Feedback regulation/control is often used in combination with SCR for the control of NH₃ or urea injection.

Abatement of other pollutants

Lean-burn SG engines and DF engines in the gas mode are often equipped with an oxidation catalyst, mainly for CO removal. However, in the case of dual fuel engines operated on liquid fuels, the oxidation catalyst is subject to fouling and may become ineffective for prolonged operation. The NMVOC emissions from SG engines and DF engines in the gas mode depend on the natural gas composition. Depending on the legislation in force and the composition of the natural gas, NMVOC secondary emission reduction techniques might, in some cases, be needed. Oxidation catalysts for simultaneous CO and NMVOC reduction are applied in these cases. The oxidation catalyst reduction efficiency for NMVOC is very dependent on the hydrocarbon composition in the flue-gas, with ethane and propane being especially difficult to remove. The high-pressure GD-type gas engine has higher NO_x emissions than SG/DF-types in gas mode but low CO and other unburnt gaseous emissions.

7.1.1.2.3 Control of NO_x emissions to air from turbines

Three main techniques have been used to prevent or reduce the NO_x emissions.

Water or steam injection

For existing installations, water or steam injection has long been the most easily applicable technique, occasionally in combination with other NO_x abatement techniques. Nowadays, however, the most commonly used solution for new or retrofitted gas turbines combusting natural gas is to install dry low-NO_x burners.

Dry low-NO_x burners (DLN)

Dry low-NO_x burners are now widely applied for all kinds of gas turbines, including some offshore gas turbines. A general description of this technique is given in Section 3.2.2.3.7.

Catalytic solutions

Many gas turbines currently only use primary techniques to reduce NO_x emissions, but secondary techniques, such as SCR systems, have been installed in some gas turbine plants in Austria, Japan, Italy, the Netherlands and the US (especially in California). It is estimated that several hundred gas turbines worldwide are equipped with SCR systems. In Europe, SCR has been applied mainly at larger gas turbines, but has not been applied so far for mechanical drive gas turbines. Figure 7.2 and Figure 7.3 illustrate how SCR catalysts are applied within the CCGT concept; first, in a horizontal HRSG, and second, in an installation with a vertical flow set-up [268, Joisten et al. 2000]. Whilst these figures are schematics, they show the substantial space required in an existing HRSG for the gas turbine to be retrofitted with a catalyst, which may not always be available.

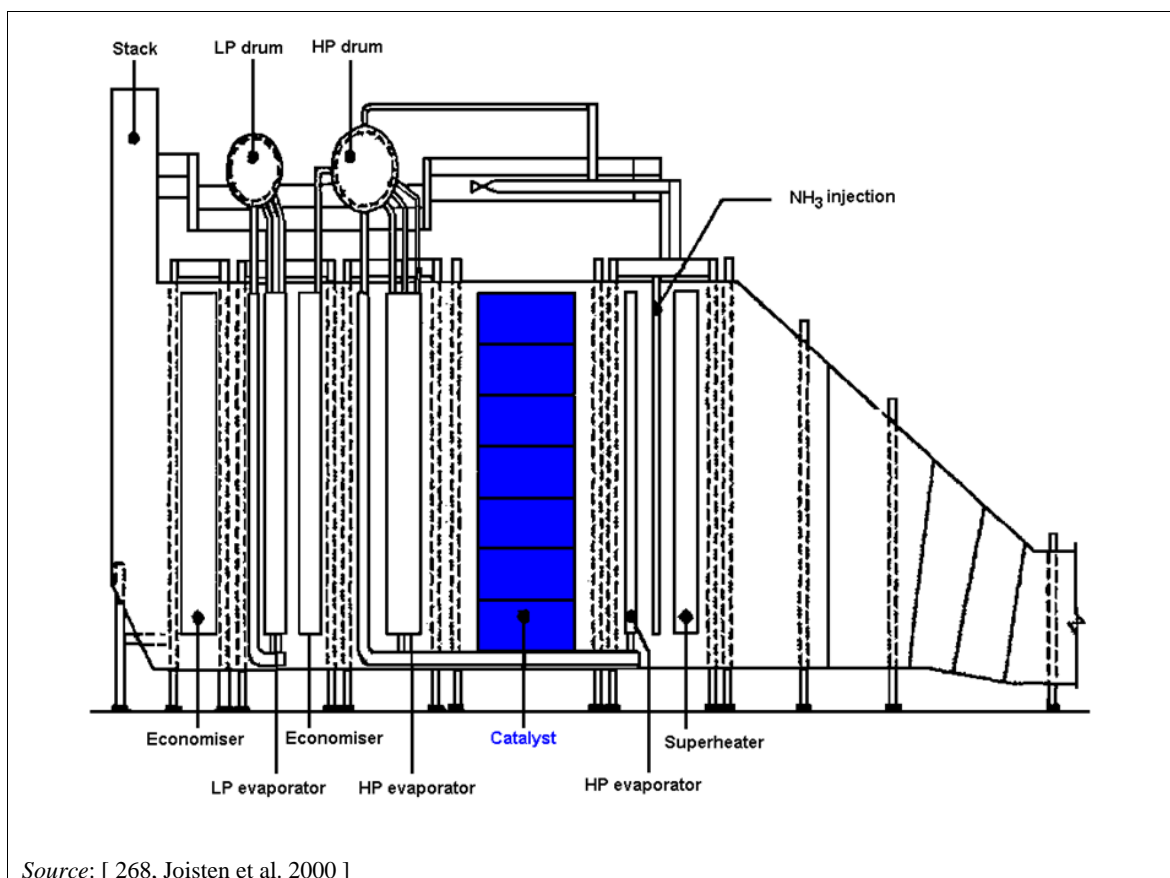

Source: [268, Joisten et al. 2000]

Figure 7.2: HRSG design and SCR installation

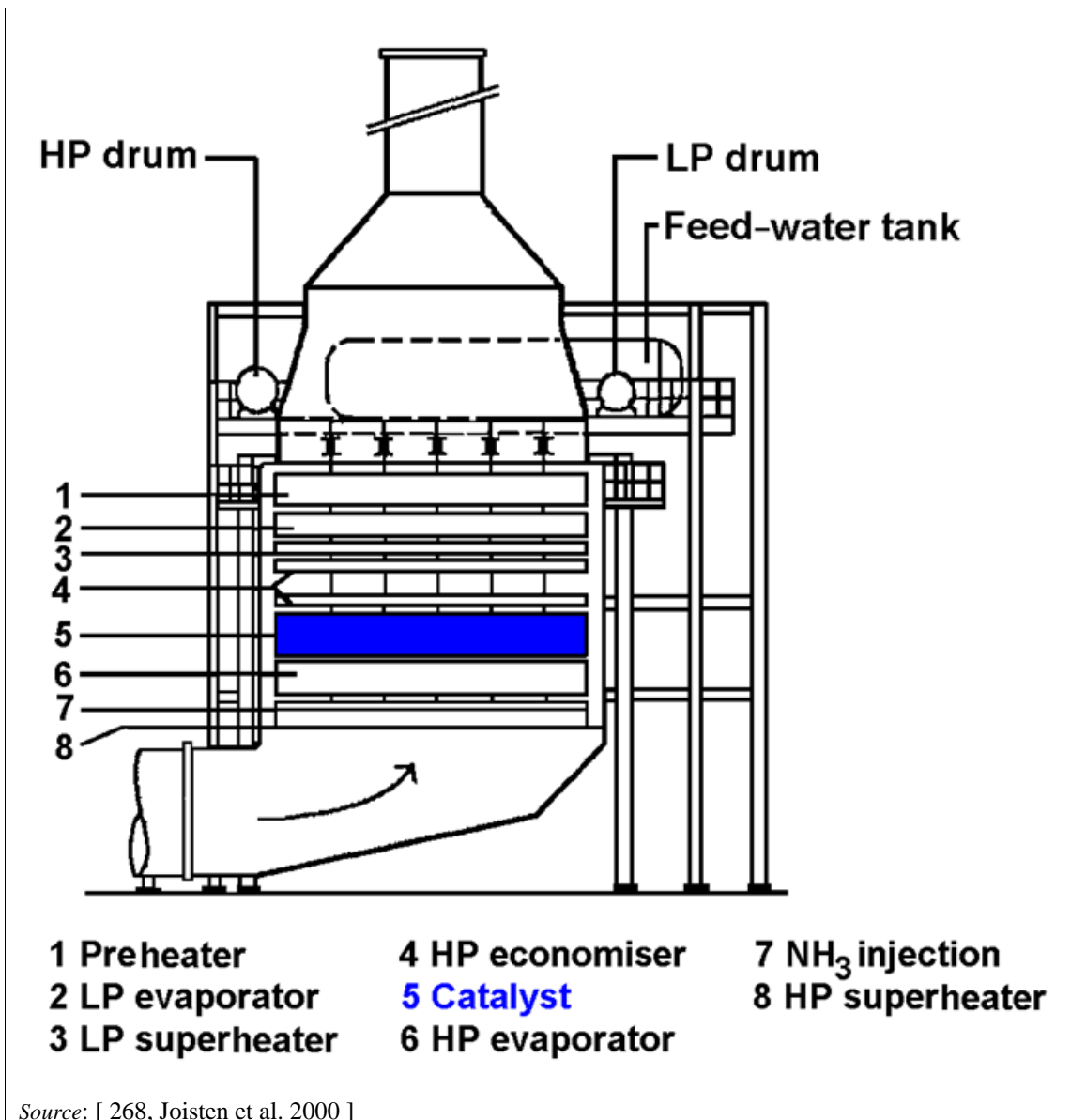

Source: [268, Joisten et al. 2000.]

Figure 7.3: SCR installation with vertical flow

When even lower NO_x emission levels are required in densely populated areas, or when very strict restrictions on NH₃ emissions are applied, a further option is the SCONO_xTM technology, which has been fitted on a few small gas turbines in the US. However, the SCONO_xTM technology has not achieved wide deployment, particularly outside North America. The regeneration cycle required by this technique adds to the cost and complexity, usually making the simpler DLN set-up preferable.

7.1.1.3 Water and waste water treatment

For the gas turbine and the HRSG, demineralised water is required for the following purposes:

- To compensate for the loss of blowdown water from the drums for the HRSG. If steam or water injection is applied, the water loss also has to be compensated for by make-up water. The quality has to meet the manufacturer's requirements and water treatment is, therefore, required. Demineralisation is usually sufficient to meet these requirements.
- For washing the gas turbine compressor mainly in the case of power or CHP plants. Condensate from the water/steam cycle is sometimes used for online washing, but usually

demineralised water is supplied to a separate water wash unit. For offline washing, a detergent is added to the demineralised water to improve the washing effect.

Waste water from a gas turbine and an HRSG (if applied) includes the following:

- Blowdown water from the boiler circulation system used to maintain the quality of the boiler water. To protect the boiler from corrosion, the boiler water usually contains additives such as ammonia, sodium hydroxide and/or phosphates. In practice, this blowdown water is quenched and discharged to sewerage systems, or to a water treatment plant if necessary.
- Waste water from the gas turbine water washing process which can be discharged or may have to be considered a chemical waste, depending on the detergents used for washing and the compressor materials to be disposed of.
- Any water that is contaminated with oil or with fluids containing oil. This is usually accumulated in a collecting system and discharged separately to a treatment plant.
- Remaining waste water from the plant, such as scrubbing water, which is normally discharged to the on-site treatment plant or to the domestic sewerage system.

Further treatment of waste water from the gas turbine (and/or HRSG if applied) may be necessary before discharging the waste water.

7.1.2 Current emission and consumption levels

This section reports currently observed emission and consumption levels from natural-gas-fired plants in Europe or worldwide. Data have been collected at the European level for the year 2010 for the review of this document.

7.1.2.1 Energy efficiency of natural gas combustion plants

Operators and suppliers continuously aim to increase the energy efficiency of combustion plants, e.g. by optimisation of the process and by new developments in materials and cooling techniques, which make higher gas turbine inlet temperatures possible. In a combined cycle, the application of more pressure stages and the increase in allowable steam inlet temperatures (made possible by the development of high-temperature-resistant materials) also enable an increase in the efficiency of the steam cycle.

The Grassmann diagram in Figure 7.4 shows the energy flow through a combined-cycle gas turbine without supplementary firing. The areas shaded grey represent the internal losses of energy in the gas turbine and in the heat recovery steam generator (HRSG).

Mass stream overview

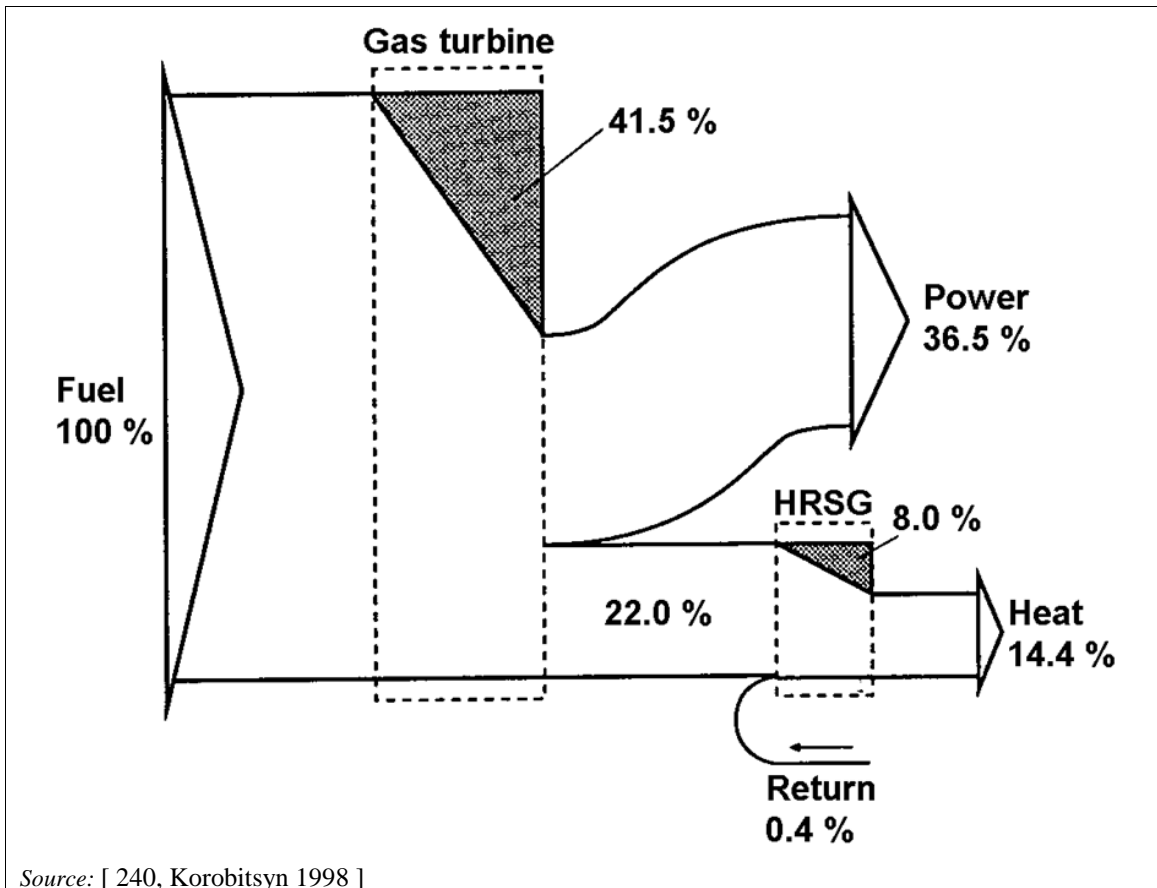

Figure 7.4: Grassmann diagram of a gas turbine with HRSG

Table 7.2 gives an overview of the energy efficiencies of gas-fired power units designed for electricity production at baseload. The reported energy efficiency values apply to recently installed gas turbines at full load, under ISO conditions and with once-through cooled condensers.

Table 7.2: Overview of typical ISO efficiencies of natural-gas-fired combustion units

	Maximum unit size (MW _e)	Net electrical efficiencies under ISO conditions (%)
Boiler	800	38–43
Simple cycle gas turbine	340	30–41
Simple cycle spark-ignited (SG) or dual fuel (DF) engine	NA	30–44
Combined cycle with HRSG	500	46–60
Topping cycle with hot wind box	NA	50

NB:
NA: Not available.
Source: [241, Eurelectric 2012]

For other operating conditions, the values may be lower, as efficiency depends on ambient conditions and the type of cooling system, as well as on the operating mode.

Table 7.3 gives an overview of the operating net electrical efficiencies and operating net total fuel utilisation ratios of existing gas-fired power units operated in Europe in 2010.

Table 7.3: Overview of operating energy efficiencies (yearly averages) of European natural-gas-fired combustion units

	Combustion plant rated thermal input (MW _{th})	Commissioning year	Operating net electrical efficiency (%)	Operating net total fuel utilisation (%)
Gas boiler - not CHP	180–800	1 959–1 992	16–34	16–34
Gas boiler - CHP	36–427	1 970–2 001	0–38	26–95
Simple cycle gas turbine	140–430	1 987–2 008	20–39.5	20–39.5
Simple cycle spark-ignited (SG) or dual fuel engines - CHP	15–42	1 995–2 010	39–45	56–95
Combined-cycle gas turbine - not CHP	235–2 030	1 992–2 011	33.2–57.8	33.2–57.8
Combined-cycle gas turbine - CHP (50–600 MW _{th})	57–500	1 992–2 009	22.8–46	44–94.5
Combined-cycle gas turbine - CHP (> 600 MW _{th})	670–991	1 998–2 011	22.8–46	44–94.5

Source: [3, LCP TWG 2012.]

Unit energy efficiency can be increased by increasing the firing temperature of the gas turbine. This may not lead to an increased gas turbine exhaust temperature. In new designs of gas turbine, optimisation of the exhaust conditions may be undertaken to optimise the overall performance of the combined cycle. If the exhaust temperature is high enough, a steam reheat system may be economically attractive.

Various process modifications can be applied to improve the energy efficiency of gas turbines. For example, regeneration can improve efficiency by transferring waste heat to the compressor discharge air, thus reducing fuel consumption, although this might also result in a certain reduction of power. In cogeneration, the energy released in the combustion process is used to produce both electricity and useful heat (see Section 3.2.3.2). Cogeneration actually reduces the electrical efficiency of the plant, but the increase in total fuel utilisation may offset this decrease if the cogeneration heat demand is stable and at the envisaged design point. High quality fuels are used for combined-cycle plants with HRSGs to avoid corrosion/erosion problems.

Some effects can diminish electrical efficiency in real operating cycles, such as inefficiency in compression and expansion, loss of pressure during heat addition and rejection, variation of working fluid specific heat with temperature, incomplete combustion, etc. [157, Molero de Blas 1995.]

Figure 7.5 gives an overview of the operating electrical efficiencies of European CCGTs designed for different purposes, from electricity production to generation of combined heat and power at industrial facilities. These operating efficiencies are yearly averages and cover the full range of different situations that may affect efficiency, e.g. different load modes and factors, different cooling systems, different ages or climatic conditions (temperature, humidity).

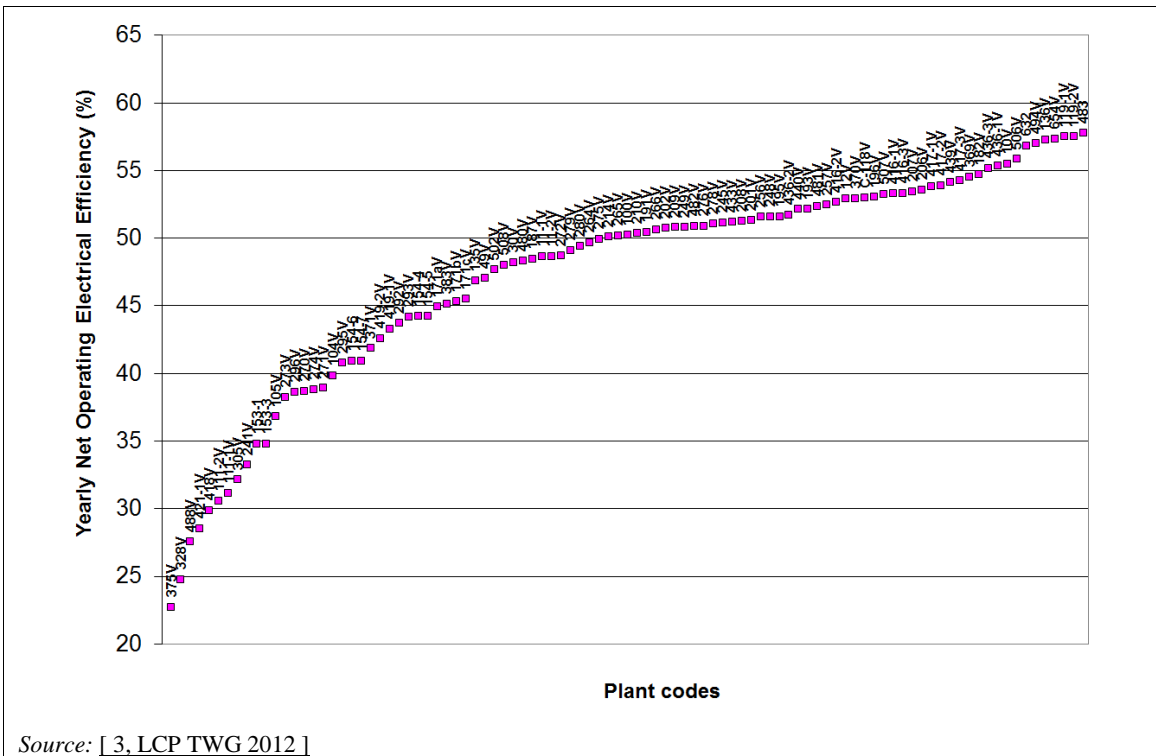

Figure 7.5: Net operating electrical efficiencies of CCGTs in Europe in 2010

Figure 7.6 and Figure 7.7 illustrate the absence of a real global difference in operating electrical efficiencies between CCGTs with and without supplementary firing. No further distinction has been made in this document between these two plant types regarding energy efficiency. However, at individual plant level, installing supplementary firing may increase the energy efficiency. This depends on the design of the HRSG and supplementary firing arrangement used. Specifically, the energy efficiency may only be increased if the steam temperature and pressure are raised, and not if only the amount of steam is increased.

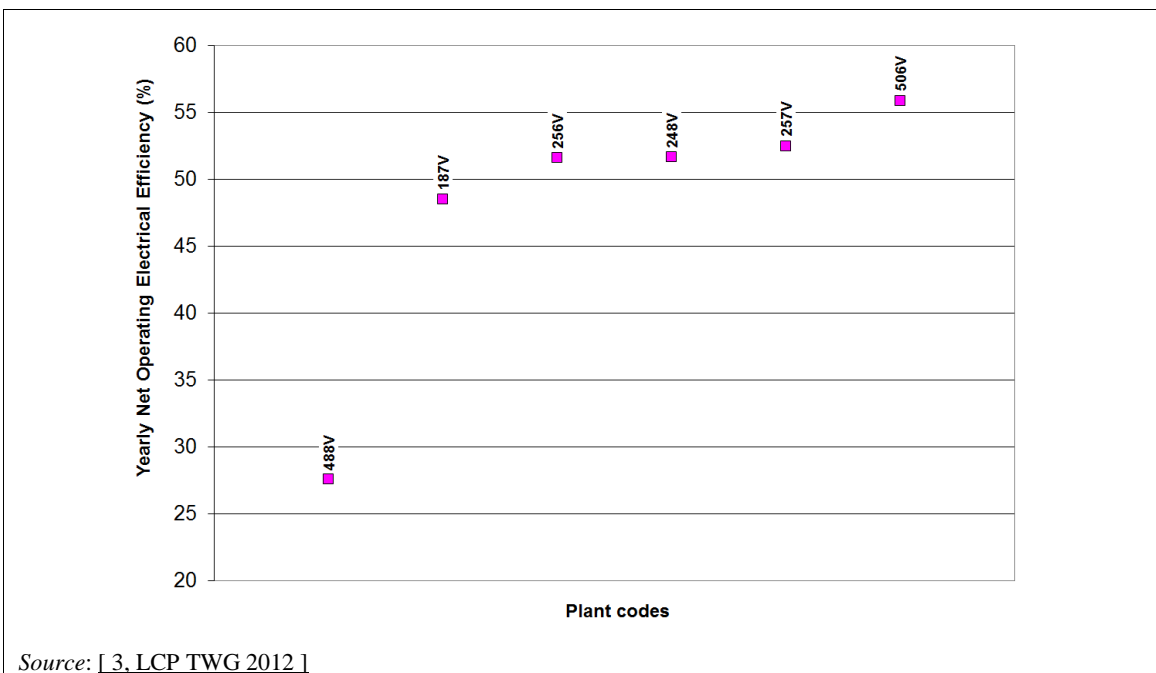
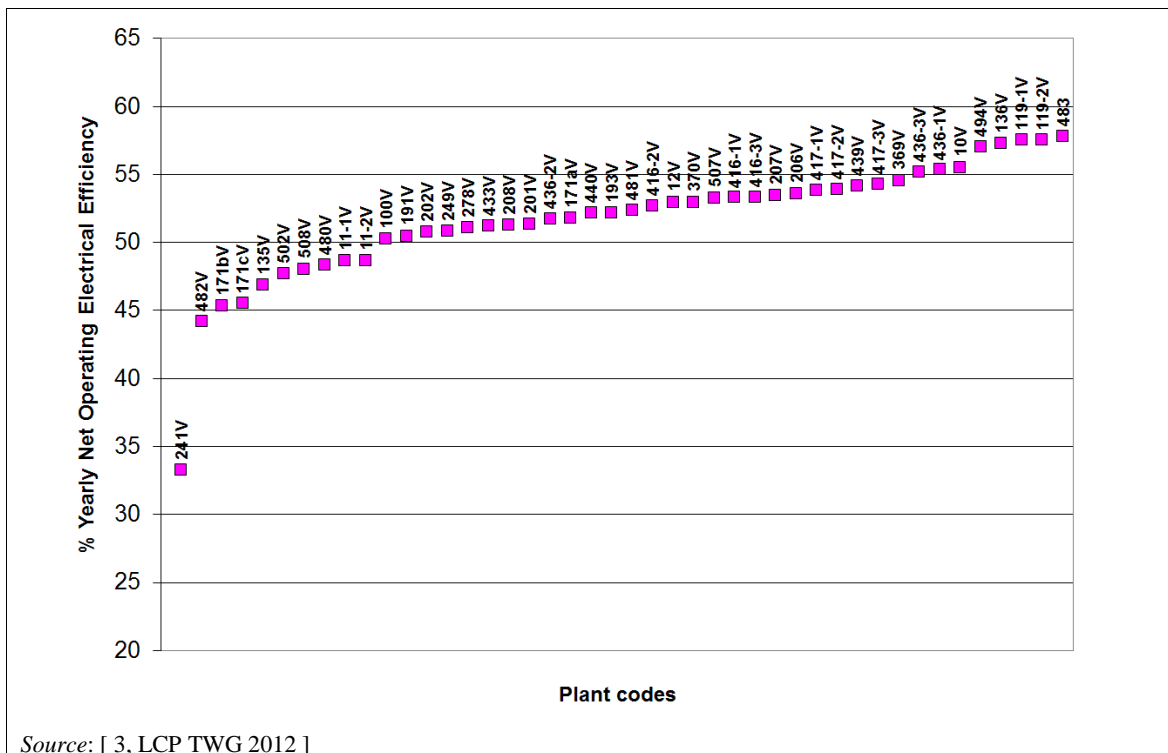

Figure 7.6: Net operating electrical efficiencies of CCGTs with supplementary firing in 2010



Source: [3, LCP TWG 2012]

Figure 7.7: Net operating electrical efficiencies of CCGTs without supplementary firing in 2010

Figure 7.6 and Figure 7.7, the operating electrical efficiencies of CCGTs operated $\geq 4\,000$ h/yr and CCGTs operated between 1 000 h/yr and 4 000 h/yr are compared. Since these two categories of plants have the same range of efficiencies, the number of operating hours per year has not been further considered as a discriminating parameter for energy efficiency, unless plants operate very few hours (< 500 h/yr) in which case it may not be economically viable to retrofit existing units with costly improved techniques.

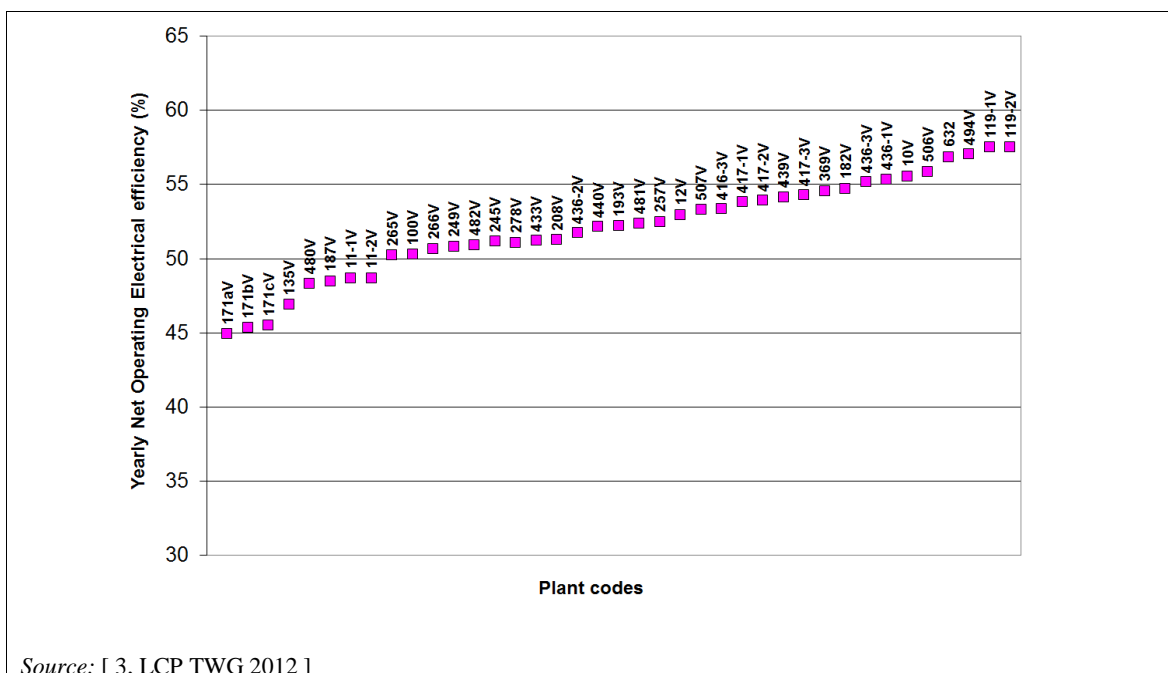

Source: [3, LCP TWG 2012]

Figure 7.8: Net operating electrical efficiencies of CCGTs producing only power operated $\geq 4\,000$ hours in 2010

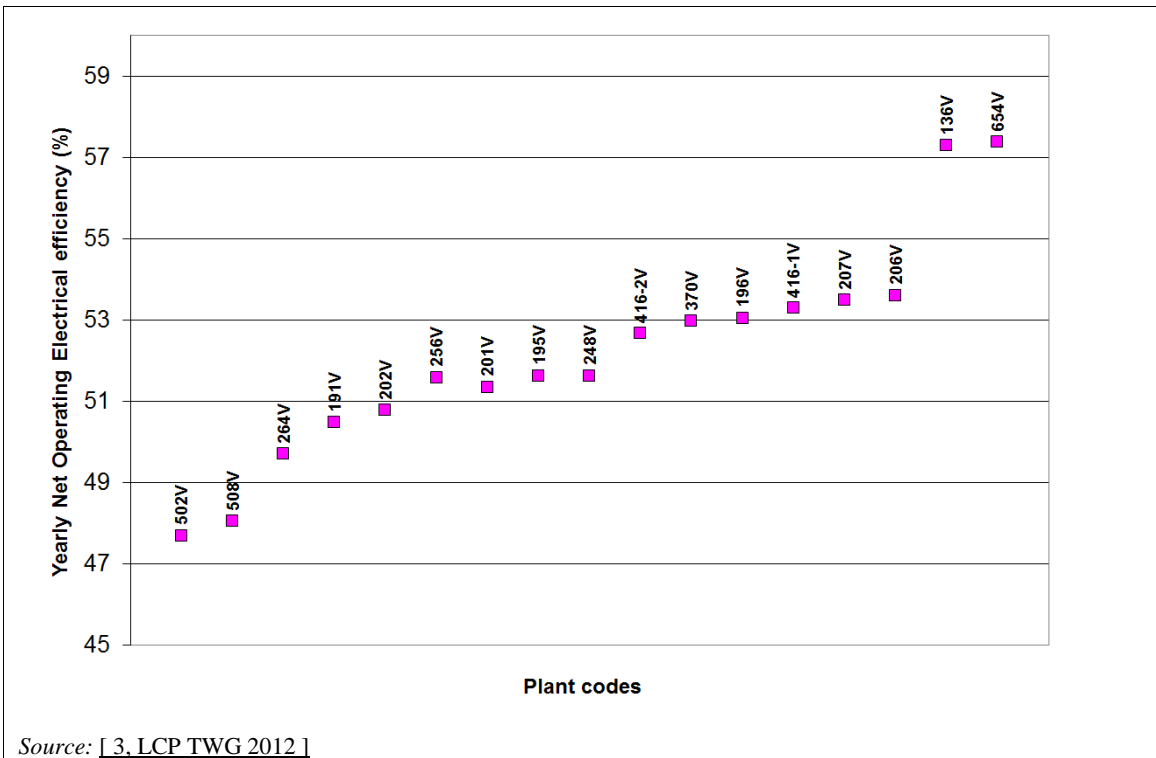

Source: [3, LCP TWG 2012]

Figure 7.9: Net operating electrical efficiencies of CCGTs producing only power operated < 4 000 hours in 2010

Natural-gas-fired boilers are often used in Europe to produce hot water or steam for district heating or for specific industrial applications such as chemical or oil refining. Therefore, their electrical efficiency is very low, or even negative when they import their electricity from the grid, but they have high fuel utilisation levels.

Figure 7.10 illustrates the high fuel utilisation of natural-gas-fired boilers despite their low electrical efficiencies.

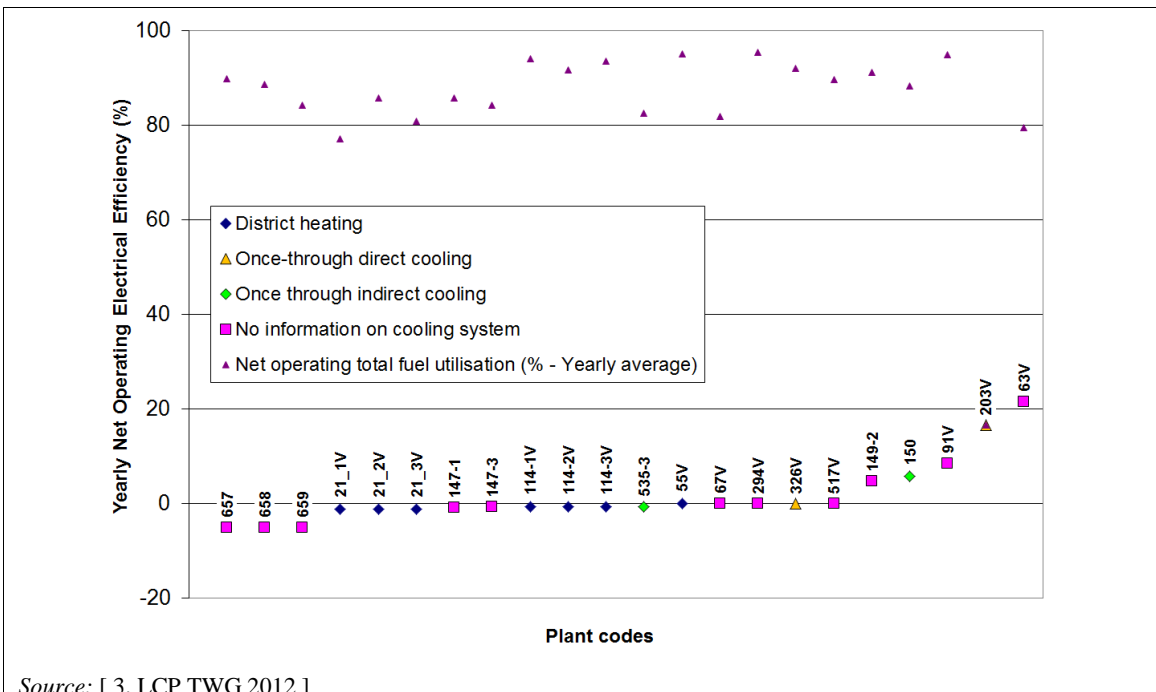

Source: [3, LCP TWG 2012]

Figure 7.10: Net operating electrical efficiencies and total fuel utilisation in 2010 of natural-gas-fired boilers

7.1.2.2 Emissions to air

In gas-fired combustion plants, the generation of NO_x emissions is mainly due to the formation of thermal NO_x . This is influenced by the following parameters [132, Rentz et al. 1999]:

- **Fuel composition:** As the hydrogen content of the fuel increases, NO_x emissions increase. A higher alkane content in the natural gas also tends to increase the NO_x emission. A higher non-N inert content reduces the NO_x emission.
- **Flame temperature:** When fuel and air are combusted at the stoichiometric ratio, the highest flame temperature is reached, resulting in the highest NO_x emissions.
- **Residence time of the fuel-air mixture in the combustion zone:** Residence time can be reduced by using an increased number of burners and a constant fuel and air flow. This is a way to reduce NO_x formation and was applied at an early stage in gas turbine development.
- **Atmospheric conditions:** An increase in the humidity of the combustion air also helps to reduce NO_x formation. This effect causes a reduced flame temperature, similar to the injection of a water/fuel-emulsion into the combustion chamber of the gas turbine.

The variation in load of the combustion plant responding to variations in the energy demand may influence the level of NO_x emissions based on the evolution of the aforementioned physical parameters. For further details, see Section 3.1.15.

For natural-gas-fired combustion plants, emissions of dust and SO_2 are very low: normally well below $5 \text{ mg}/\text{Nm}^3$ for dust and well below $10 \text{ mg}/\text{Nm}^3$ for SO_2 (15 % O_2), without applying any techniques at the plant level. Thus continuous monitoring of SO_x and dust is generally not performed for natural-gas-fired combustion plants.

Gas turbines

Figure 7.11 gives a general overview of NO_x emission levels from a data set of European example plants, regardless of the implemented techniques or the way the plants are operated.

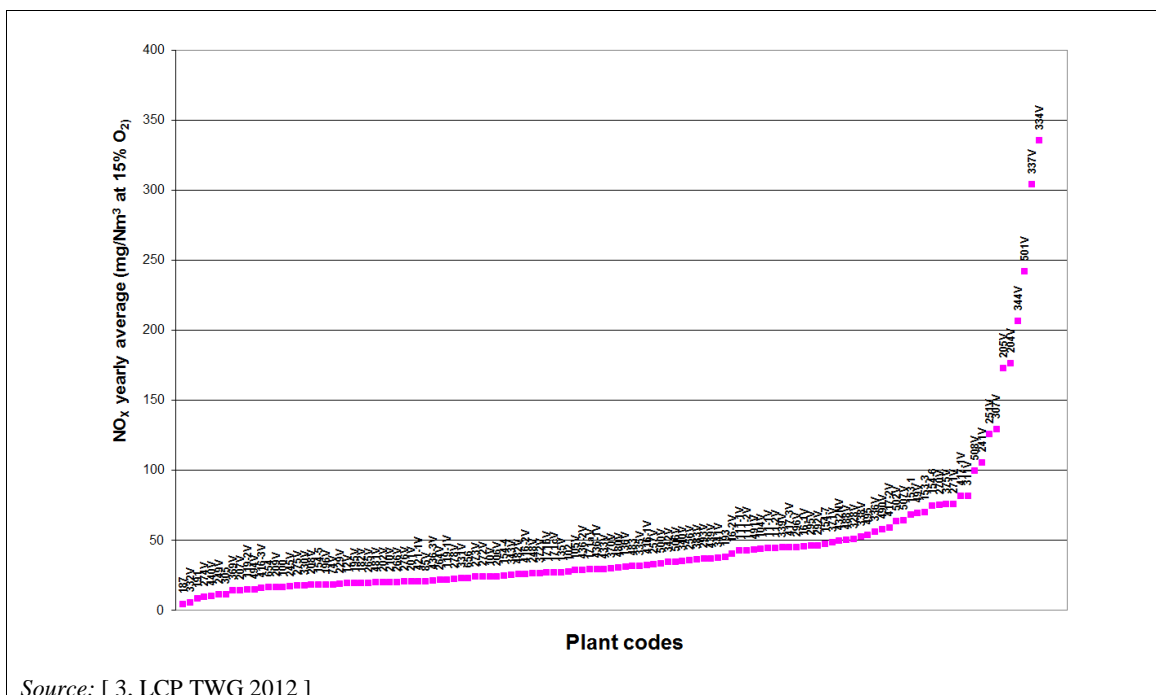

Figure 7.11: NO_x emissions from European natural-gas-fired turbines in 2010

NO_x emission levels depend on the type of gas turbine and may be affected when trying to increase energy efficiency, as this leads to higher firing temperatures in the gas turbine. With increasing temperature, NO_x emission levels tend to increase, much faster than the efficiency of electricity generation. At combustion temperatures beyond 1450 °C, NO_x generation increases exponentially with temperature. The influence of temperature and pressure on NO generation (the majority compound within emitted NO_x) is presented in Figure 7.12. This shows that, for high combustion temperatures, an increase in the combustion temperature by 50 °C approximately doubles the NO emissions. Therefore, technical developments to higher efficiencies may also imply higher NO_x emission levels in mg/Nm³.

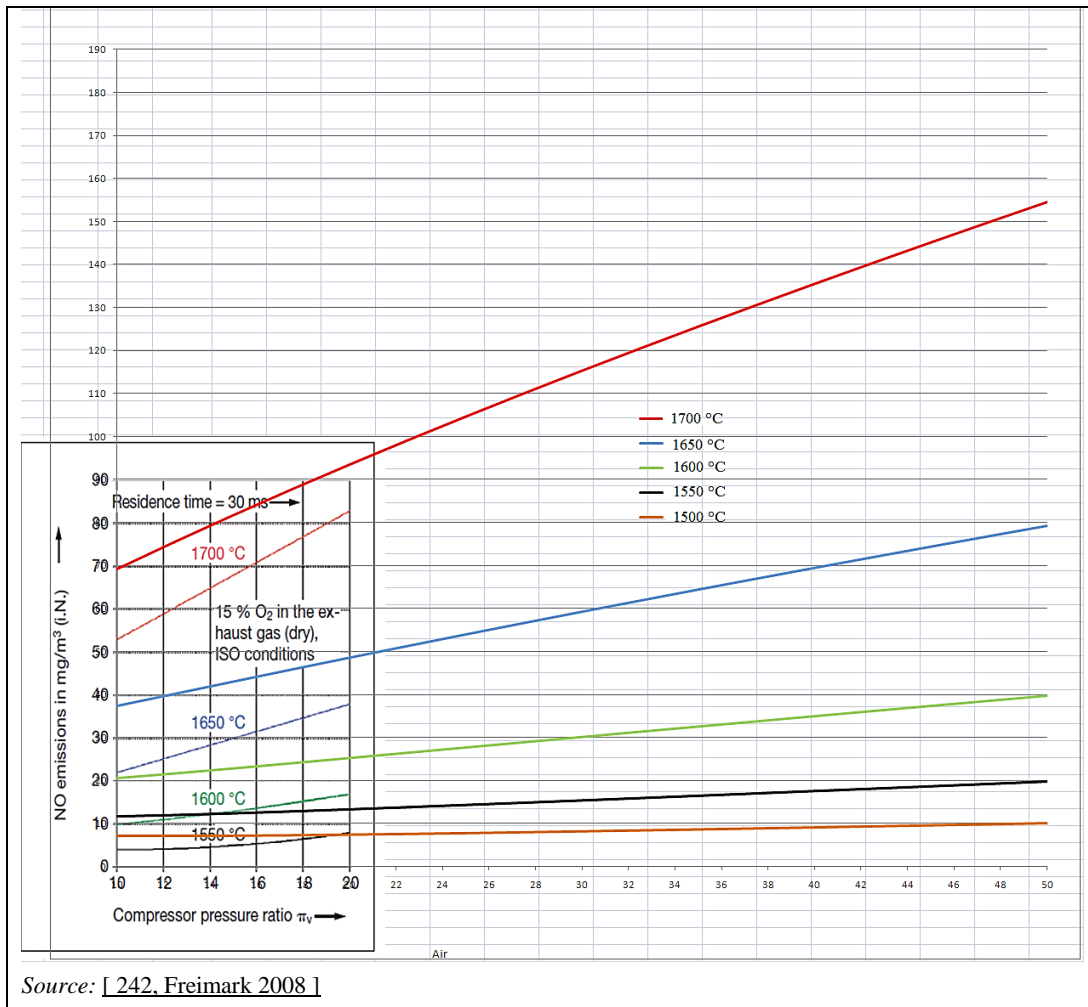

Figure 7.12: NO emissions as a function of the pressure with various combustion temperatures and a residence time in the reaction zone of 30 ms

In order to take an integrated view of the environmental performance of the gas turbine, i.e. including emissions and electrical efficiency, one possibility is to consider specific NO_x emissions for each MWh_e produced or to introduce a flexible factor characterising the balance between the NO_x emissions and energy efficiency of the plant. This correction factor principle [Eta algorithm] is illustrated in Table 7.4, where three 100 MW_e gas turbines with different electrical efficiencies and uniform emission levels of 50 mg NO_x/Nm³ are presented. According to this table, less efficient plants release a higher NO_x load than more efficient ones, whereas they both achieve the same NO_x emission levels expressed in concentration (case 1), or plants releasing the same load of pollution but being more efficient may benefit from higher emission levels expressed in concentration (case 2).

Table 7.4: Calculated specific NO_x emissions with emission levels of 50 mg/Nm³

Electrical capacity (MW _e)	Electrical efficiency, per cent	Thermal capacity (MW _{th})	NO _x emission levels (mg/Nm ³) case 1	Specific NO _x emissions (g/MWh _e) case 1	NO _x emission levels (mg/Nm ³) case 2	Specific NO _x emissions (g/MWh _e) case 2
100	35 %	286	50	433	50	433
100	38.5 %	260	50	394	55	433
100	42 %	238	50	360	60	433

Source: [242, Freimark et al. 2008]

Modern combined-cycle plants with dry low-NO_x burners have overcome this 'trade-off' problem and achieve NO_x emission levels of 15–35 mg/Nm³, without using end-of-pipe NO_x-reducing techniques, while still achieving high operating electrical efficiencies (above 55 % on a yearly average basis). In the case of open-cycle plants, the corresponding electrical efficiency is about 39 % (e.g. operating net electrical efficiency achieved by Plants 16-1V and 16-2V).

Figure 7.13 provides data on example CCGTs commissioned between 2007 and 2010, operated between 1 600 h/yr and more than 8 000 h/yr, with an equivalent full load factor above 74 % and with operating electrical efficiencies above 55 %. The NO_x yearly average (concentration) to operating electrical efficiency ratio varies from 0.25 to 0.6 mg/Nm³.MW_e.

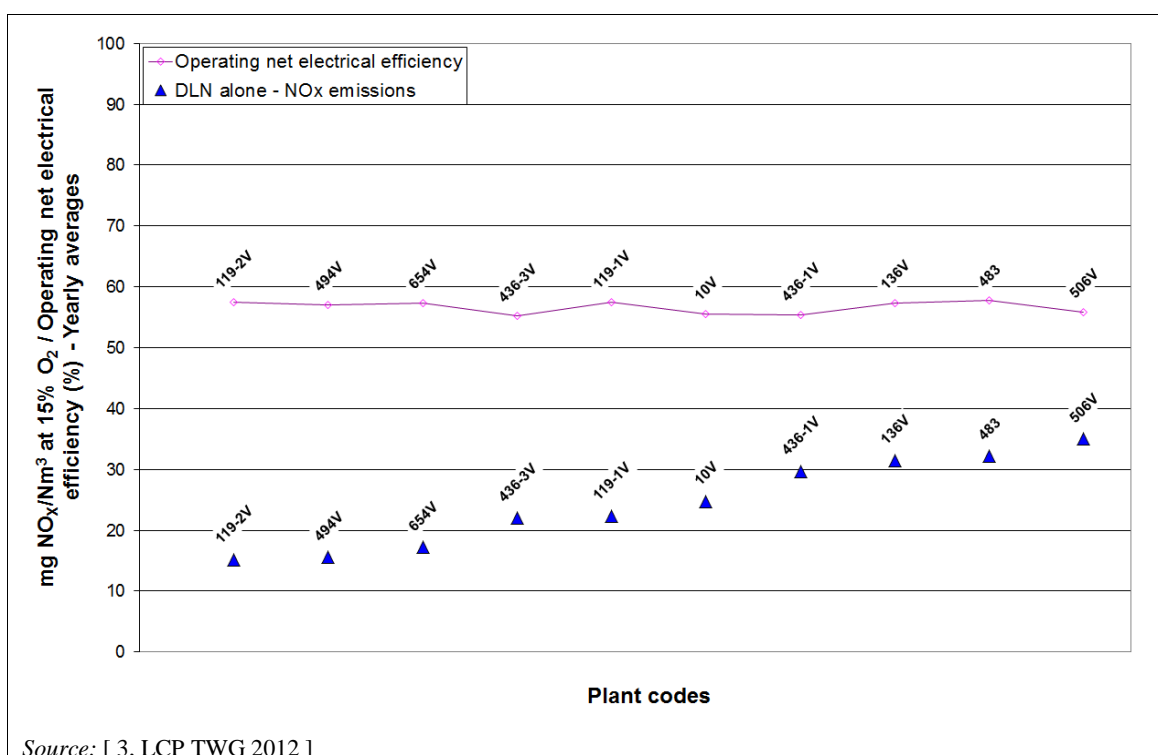
**Figure 7.13:** Example of CCGTs achieving low NO_x emissions and high operating electrical efficiencies

NO_x emissions from older plants can vary between 50 mg/Nm³ and 75 mg/Nm³, or even higher (very old gas turbines commissioned before 1990 can reach levels of up to 350 mg/Nm³). Nowadays, DLN retrofit packages are available on the market, delivering NO_x emission levels below 50 mg/Nm³. However, lower emission levels of NO_x may lead to higher CO emissions for these plants.

Since no major technical problems with waste heat boilers (combined-cycle/cogeneration) have been observed with gas turbines equipped with SCR technology, SCR can be considered a proven technique to reduce NO_x emissions from gas-fired installations. Disadvantages of SCR include pressure loss and a resulting loss in efficiency (increase of CO₂), as well as possible emissions of ammonia, and these need to be taken into account in the integrated pollution prevention approach. According to [132, Rentz et al. 1999], NO_x emissions of 20 mg/Nm³ and less are achieved at a site in California using SCR. At that site, NO_x emission values have to be below 20 mg/Nm³ because of ambient air quality problems for most of the year, including extremely high ozone concentrations or continuous summer smog periods. In Japan and in Europe, levels of 10–50 mg/Nm³ (15 % O₂) for large gas turbines (> 100 MW_{th}) are commonly achieved with natural gas firing, mainly by using only dry low-NO_x systems. In some cases in Austria, the Netherlands or Italy, SCR has also been implemented, achieving yearly average NO_x concentrations of between 14 mg/Nm³ and 23 mg/Nm³.

As shown in Figure 7.14 and Figure 7.15 there is no higher NO_x emission levels from CCGTs fitted with supplementary firing at the HRSG level than from those not fitted with it, as also underlined in the document [186, UK 2013]. Therefore, no further distinction is made in this document between CCGTs with supplementary firing and those without with respect to NO_x emission levels.

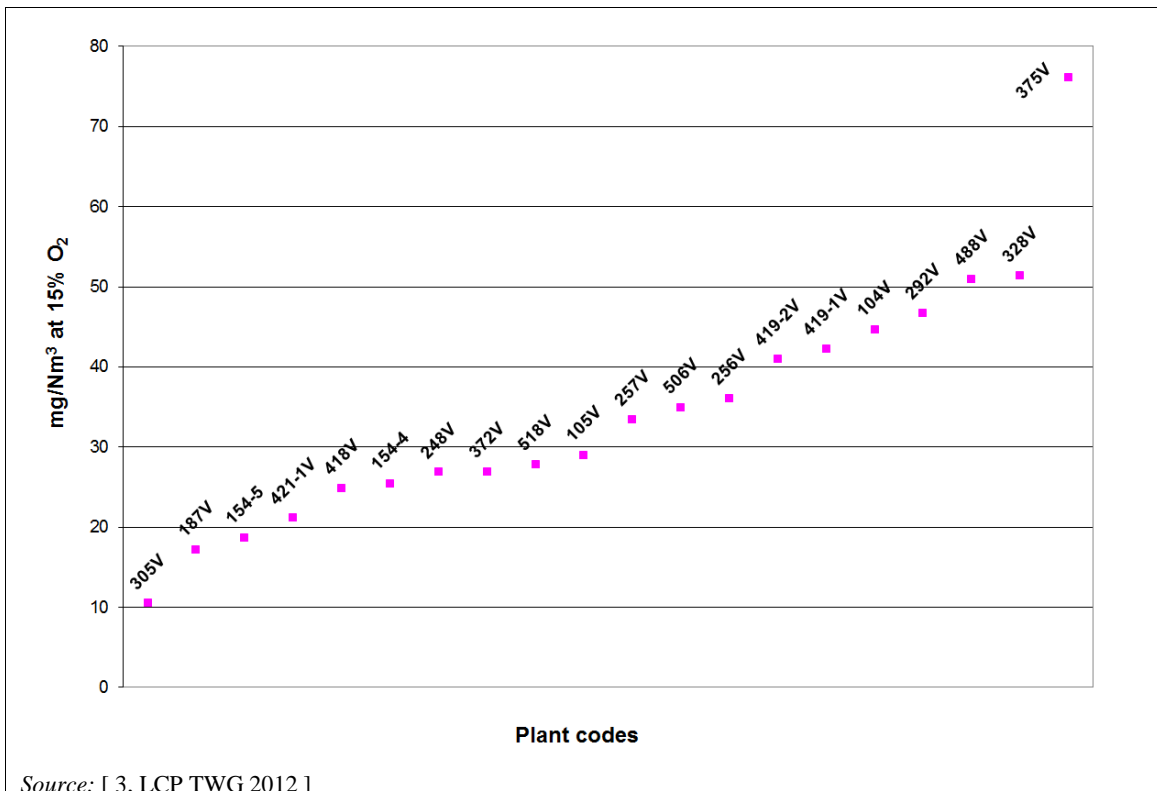

Figure 7.14: NO_x emissions (yearly averages) from CCGTs fitted with supplementary firing at the HRSG level

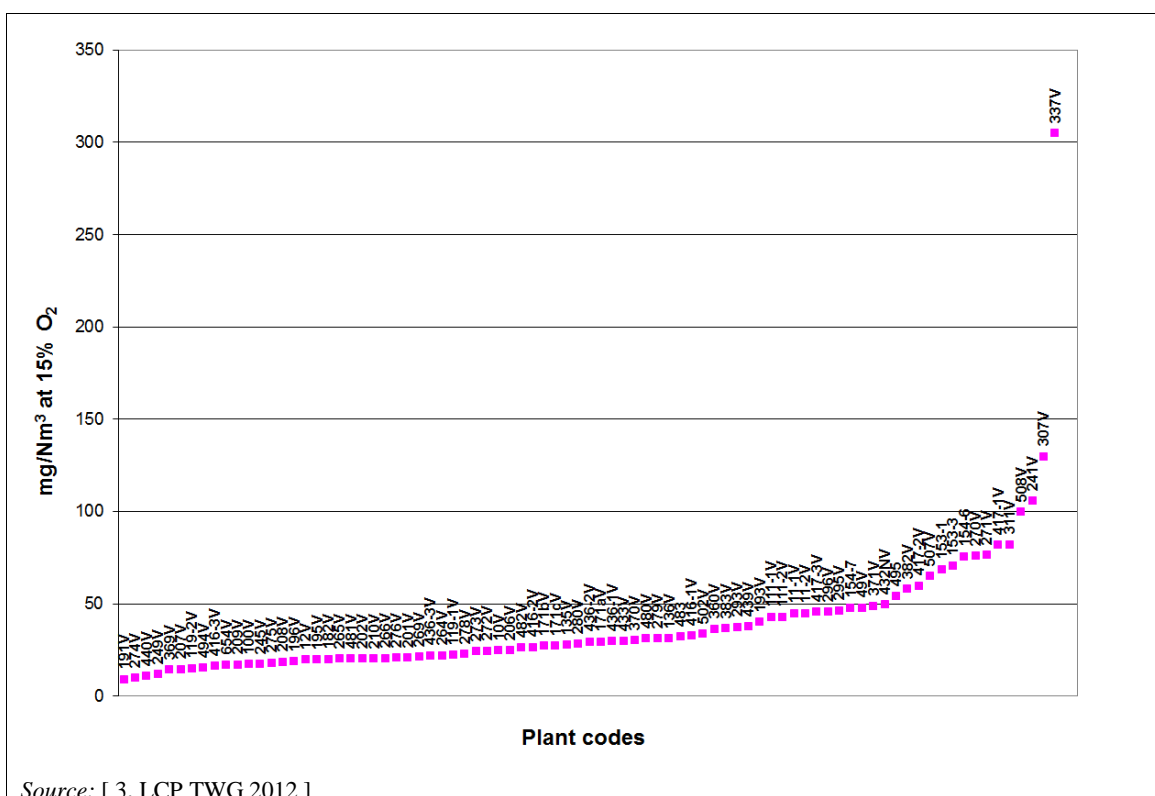

Figure 7.15: NO_x emissions (yearly averages) from CCGTs without supplementary firing at the HRSG level

Table 7.5 gives an overview of different pollutant emission levels from European natural-gas-fired turbines in 2010

Table 7.5: Example of emissions to air from natural-gas-fired turbines in 2010

Combustion technique	Combustion plant rated thermal input (MW _{th})	Emissions to air (mg/Nm ³ – yearly average of hourly averages at 15 % O ₂)			
		NO _x	Dust	CO	SO _x
Single fuel open-cycle gas turbine	13–690	6–335	0.1–2	2.4–225	0.04–3
Dual fuel open-cycle gas turbine	150–300	40–180	NA	6–80	NA
Single fuel combined-cycle gas turbine	18–770	10.5–305	0.007–7.7	0.15–80	0.05–2.9
Dual fuel combined-cycle gas turbine	207–1815	9–82	0.06–1.2	0.4–52	0.2–7.8

NB:
NA: Not available.
Source: [LCP TWG data collection 2012]

Gas engines

Table 7.6 and Table 7.7 present emission levels from some example engine plants.

Table 7.6: Examples of NO_x emissions for steady-state full engine load (15 % O₂)

Installation	Fuel used	NO _x (as NO ₂) ⁽¹⁾ (mg/Nm ³)	Average dust (ISO 9096 or equivalent method) (mg/Nm ³)	Remarks
Gas diesel (GD) in gas mode	Main fuel: natural gas; pilot fuel: heavy fuel oil (2.9 wt-% S, 0.05 wt-% ash, 9 wt-% micro carbon residue)	1584–1612	10–13	120 MW _e power plant in Asia
Spark-ignited gas engine (SG)	NA	161–190	NA	5 MW _e plant in Northern Europe
	NA	100–280	NA	22 MW _{th} two-stroke engine used for mechanical drive in Europe [Plant 166]
Spark-ignited gas engine (SG) (low- NO _x tuned)	NA	71–83	NA	40 MW _e plant in America. Fuel consumption about 3 % higher compared to ‘normal’ rated SG
	NA	95–190 ⁽²⁾	NA	Spark plug engine in lean-burn mode [23, Finland 2012]
	NA	165	NA	NO _x yearly average. Lean-burn concept. 54 MW _{th} Hungarian plant
	NA	109	NA	Lean-burn concept. 15 MW _{th} Estonian plant [Plant 40]
	NA	150–175	NA	Lean-burn concept. 18 MW _{th} Hungarian plant [Plant 186]
Spark-ignited gas engine (SG)	NA	5–13	NA	SCR Fresh conditions
	NA	27–28	NA	NO _x yearly average. Lean-burn concept + SCR. 30/35 MW _{th} plant in Italy
Dual fuel engine - gas mode - gas oil mode	< 0.05 wt-% S, < 0.01wt-% ash	147–177 1531–1751	NA 6–27	5 MW _e plant in Northern Europe
Dual fuel engine in gas mode	NA	190–380 ⁽²⁾	NA	[23, Finland 2012]

⁽¹⁾ NO_x emission given at 0 °C, 101.3 kPa, dry gas.
⁽²⁾ SG engines using primary NO_x reduction measures achieve levels of about 190 mg/Nm³ with an optimal heat rate, and about 100 mg/Nm³ if the SG engine is low NO_x tuned at the expense of an increased fuel consumption. DF-type engines in gas mode using only primary NO_x abatement techniques can, with a natural gas quality with a methane number (MN) higher than 80, be tuned for achieving 190 mg/Nm³. A DF engine in high efficiency tuning (optimum heat rate) achieves NO_x emission levels of about 380 mg/Nm³.
NB:
NA: Not available.
Source: [169, TWG 2006 LCP BREF 2003] [23, Finland 2012] [3, LCP TWG 2012] [243, EUROMOT 2016]

Table 7.7: Example emissions of NMVOC, CO and CH₄ reported by European natural-gas-fired engines (15 % O₂)

Plant number	Emission levels (mg/Nm ³)		
	CH ₄ ⁽¹⁾	CO	NMVOC
40	NA	44	4.4 ⁽⁴⁾
166V	NA	85–90	NA
186-1V	212 ⁽²⁾	100	NA
353V ⁽³⁾	280	37	44
354V ⁽³⁾	471	39	25

⁽¹⁾ Expressed as C at full load.
⁽²⁾ Periodic monitoring once a year.
⁽³⁾ Two-stroke engine type.
⁽⁴⁾ This emission level is contested by Euromot based on estimation from an engine supplier.
 NB:
 NA: Not available.
 Source: [3, LCP TWG 2012]

Further information on unburnt carbon emissions is given in Section 7.1.3.2.5.

The efficient combustion of gaseous fuels does not generate particulates. However, local effects influence the inlet particulate levels and may affect gas turbine operation/emissions. [269, GE 2002]

Gas boilers

Natural-gas-fired boilers are used for different purposes in the power industry, or for providing heat/steam in dedicated industries, such as the chemical, food and drink, and pulp and paper industries. The most commonly applied techniques are primary techniques such as air/fuel staging, flue-gas recirculation, and low-NO_x burners, including ultra-low-NO_x burners (ULNBs) (see Section 3.2.2.3). Gas-fired boilers may be quite old but still generally retrofittable with primary techniques in order to prevent the generation of NO_x emissions, or with secondary techniques such as SNCR or SCR to reduce the NO_x generated.

Figure 7.16 gives an overview of NO_x emission levels from European natural-gas-fired boilers for 2010.

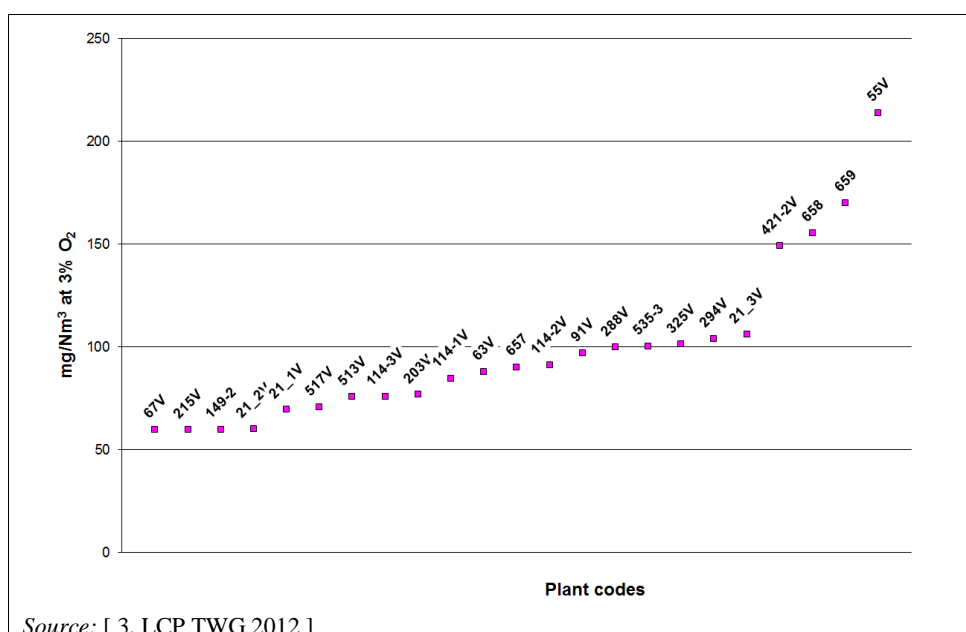

Figure 7.16: NO_x emissions (yearly averages) from European natural gas boilers in 2010

Figure 7.16 gives an overview of different pollutant emission levels from European natural-gas-fired boilers in 2010.

Table 7.8: Example of emissions to air from natural gas fired-boilers in 2010

Combustion technique	Combustion plant rated thermal input (MW_{th})	Emissions to air (mg/Nm^3 – yearly average of hourly averages at 3 % O_2)			
		NO_x	Dust	CO	SO_2
Gas-fired boiler	18–800	60–215	0.04–6.4	0.2–375	0.14–5.1
<i>Source: [3, LCP TWG 2012]</i>					

7.1.2.3 Emissions to water

The operation of gas-fired plants leads to the following specific waste water:

- **Scrubbing leakage and rinsing water:** scrubbing, leakage and rinsing waters are carried off to the sewer via an oil separator. The amount is normally about $0.1 m^3/h$ and can be contaminated with oil. Peaks in the amount of waste waters can occur if the pipelines have to be flushed. In this case, oil presence is not expected and the contamination consists mainly of sediment. Gas turbine compressors need to be cleaned periodically with water and detergent. The frequency of the on/off-line blade washes depends on the type and technology of the air intake filters and on the environment in which the gas turbine is operated. If the detergent used is biologically degradable, it is discharged to the surface water. If heavy metals are present, the water is collected and disposed of off site by an authorised contractor.
- **Boiler water blowdown:** boiler water that is drained from the boiler for maintenance purposes is collected and can be treated in a neutralisation basin. After neutralisation, the water is discharged to the surface water. Boiler water is demineralised water with supplementary chemicals. The boiler is drained as per the operational requirements of the plant; this maybe several times a year following maintenance patterns and depends on the results of water chemistry analysis. It can also depend on the running mode, with plants operated $< 4\ 000$ h/yr likely to be drained more often. The salt content in the water/steam circuit needs to remain within the specifications, to prevent deposits from evaporation and overheating pipes and to prevent accelerated corrosion. To keep the salt level in the specified range, boiler water is regularly (if necessary) blown down from the drum to the cooling water system. Consequently, the blowdown water contains low salt concentrations. It can also be recycled back to the cooling tower to save make-up water.
- **Blowdown from demineralisation installation:** water treatment plant effluents are collected and neutralised before discharging to surface water. Some parts of the demineralisation plant neutralisation waste (e.g. rinse water) can be reused as water feed to the plant.

If these streams contain pollutants (e.g. metals) they may need further treatment before discharge.

7.1.2.4 Combustion and other plant residues

The operation of gas-fired plants leads to the following specific combustion and other plant residues:

- **Solid and liquid residues:** Small quantities of solid and liquid residues may be produced by the operation of gas-fired plants. Most of the residues are the product of subsidiary activities, such as maintenance and water treatment. The waste substances associated with these subsidiary activities may include scrap metal, used oil, packaging materials, liquids used to wash down the compressors/gas turbines, ion exchangers, and activated carbon.
- **Used oil:** Normally, the gas turbine/engine control oil and lubricating oil are changed every ten years or depending on the analysis results. The quantity of oil involved on each occasion is about 25 000–40 000 litres per 400 MW_e unit in the case of a gas turbine and depends on specific plant configurations (separate seal and power oil systems, number and type of bearings, etc.).
- **Cleaning liquids:** The liquids used to wash the compressors and gas turbines are synthetic detergents dissolved in water. These liquids are used periodically to remove dirt and grease deposits from the blades; cleaning takes place during shutdown periods. The resulting dirty liquids are sent to an authorised processor.
- **Demineralised water chemicals:** Demineralised water installations produce waste chemicals and resins. If an ion exchange installation is used, the chemicals used are hydrochloric acid (or sulphuric acid) and caustic soda. The salts are normally discharged into the surface water after neutralisation. The resins are changed once every three to five years. The amounts of chemicals used and the waste resins depend on the type of installation, the raw water quality, and the amount of demineralised water produced.
- **Used catalyst:** If the plants apply a CO catalyst and/or SCR system, spent catalysts are generated every few years in small quantities.

7.1.3 Techniques to consider in the determination of BAT for the combustion of natural gas in boilers / engines / gas turbines

This section describes techniques (or combinations thereof), and associated monitoring, considered to have the potential for achieving a high level of environmental protection in the activities within the scope of this document. The techniques described include both the technology used and the way in which the installations are designed, built, maintained, operated, and decommissioned.

It covers process-integrated and end-of-pipe techniques. Waste prevention and management, including waste minimisation and recycling procedures, are also considered. Furthermore, techniques for reducing the consumption of raw materials, water, and energy are covered.

Annex III to the Industrial Emissions Directive lists a number of criteria for determining BAT, and the information within this chapter addresses these considerations. As far as possible, the standard structure of Table 3.4 is used to outline the information on each technique, to enable a comparison of techniques and the assessment against the definition of BAT given in the Industrial Emissions Directive.

This section does not necessarily provide an exhaustive list of techniques that could be applied in the sector. Other techniques may exist, or may be developed, which could be considered for the determination of BAT for an individual installation.

In this section, the techniques to be considered have only been fully described when they are specific to the considered combusted fuel or applied combustion process (combustion of natural gas). Indeed, for most of the techniques, general descriptions are already presented in Chapter 3. Therefore, in order to avoid repetition, for those general techniques already described in Chapter 3, only the additional information that is specific to the combustion of natural gas is reported here in synthesis tables.

7.1.3.1 Techniques to increase the energy efficiency of natural-gas-fired plants

The energy efficiency is normally highest when the plant is operated at the design parameters. The energy efficiency usually changes throughout the operational period of the plant and may be affected by changes, for instance in the load during operation, in fuel quality, etc. The energy efficiency also depends on the cooling system of the power plant and on the energy consumption of the flue-gas cleaning system. Applying high-efficiency gas turbine systems can generate side effects, such as vibration and higher short-term NO_x emissions.

7.1.3.1.1 General techniques to increase the energy efficiency of natural-gas-fired units

Information on general techniques to increase the energy efficiency of combustion units is given in Section 3.2.3. Table 7.9 gives additional information specific to natural gas combustion. More information on cross-media effects, environmental performance and operational data is given after the table.

Table 7.9: General techniques to increase the energy efficiency of natural-gas-fired boilers, gas turbines and engines

Technique	Description	Achieved environmental benefits	Environmental performance and operational data	Cross-media effects	Technical considerations relevant to applicability		Driving force for implementation
					New units	Existing units	
Combustion cycle (boiler)							
Cogeneration of heat and power (CHP)	Cogeneration of heat and power (CHP) - see Section 3.2.3.2	Increased energy efficiency (fuel utilisation)	High operational experience	None	Generally applicable within the constraints associated with the local power and heat demand except when operated < 1 500 h/yr	Limited applicability (mainly depending on heat demand)	European Energy Efficiency Directive - Article 14
Advanced material use	Use of advanced materials to reach high operating temperatures and thus increased steam turbine efficiencies - see also Section 3.2.3.5	Increased energy efficiency	Practised in new plants	None	Generally applicable	Not applicable	NA
Double reheat	See Section 3.2.3.6	Increased energy efficiency	Practised mainly in new plants	None	Generally applicable	Not applicable	NA
Feed-water preheating using recovered heat	See Section 3.2.3.7	Increased energy efficiency	NA	None	Generally applicable	Applicability to be assessed on a case-by-case basis in relation to the plant configuration and the amount of recoverable heat	NA
					Only applicable to steam circuits and not to hot boilers		

Advanced control system	Advanced computerised control of combustion conditions for emission reduction and combustion unit environmental performance - see also Section 3.2.3.8	Increased energy efficiency	High operational experience	None	Generally applicable	NA	
Heat accumulation (heat storage) in CHP mode	See Section 3.2.3.9	NA	NA	NA	The applicability may be limited in the case of low heat load demand		NA
Gas turbines							
Air preheating	Preheating of combustion air before combustion, after being compressed - see Section 3.2.3.4	Increased energy efficiency	High operational experience	NO _x emissions tend to increase	Generally applicable within the constraints related to the need to control the NO _x emissions		NA
Advanced control system	Advanced computerised control of the gas turbine and subsequent recovery boilers - see Section 3.2.3.8	Increased energy efficiency	High operational experience	None	Generally applicable	NA	NA
Advanced material use	Increase of gas turbine inlet temperature and compressor pressure is possible by the use of advanced gas turbine materials, efficient cooling technologies and thermal barrier coatings - see also Section 3.2.3.5	Increased energy efficiency	NA	None	Generally applicable	Not applicable	NA

Gas turbines and engines							
Combined cycle	See Section 3.2.3.11	Increased energy efficiency	NA	NA	Generally applicable except when operated < 1 500 h/yr	Applicable within the constraints associated with the steam cycle design and the space availability. Not applicable to gas turbines and engines operated < 1 500 h/yr Not applicable to mechanical drive gas turbines operated in discontinuous mode with extended load variations and frequent start-ups and shutdowns	NA
Fuel pretreatment							
Fuel preheating	Preheating of fuel gas by recovering the off-gas energy content - see also Section 3.2.3.18	Higher efficiency	NA	NO _x emissions tend to increase	NA	NA	NA
					Generally applicable within the constraints related to the boiler design and to the need to control NO _x emissions		
NB: NA: No relevant specific information available.							

Cross-media effects for CCGTs

For CCGTs, the proposed techniques may only provide a marginal improvement of the total combined cycle efficiency. It should also be noted that improvements in the gas turbine efficiency may also result in a decrease in the efficiency of the steam cycle. Therefore, the overall improvement in energy efficiency of the total cycle may be less than the improvement in the efficiency of the gas turbine alone.

Environmental performance and operational data

Figure 7.17 shows the operating electrical efficiencies of some example European open-cycle gas turbines combusting natural gas. These European gas turbines have a size of about $150 \text{ MW}_{\text{th}}$ and are operated between 100 h/yr and 1 100 h/yr, with an equivalent full load factor above 66 %. They have yearly average air emissions concentrations below 50 mg/Nm^3 for NO_x and below 80 mg/Nm^3 for CO. They were commissioned between 1987 (Plant 204) and 2008 (Plants 16-1 and 16-2).

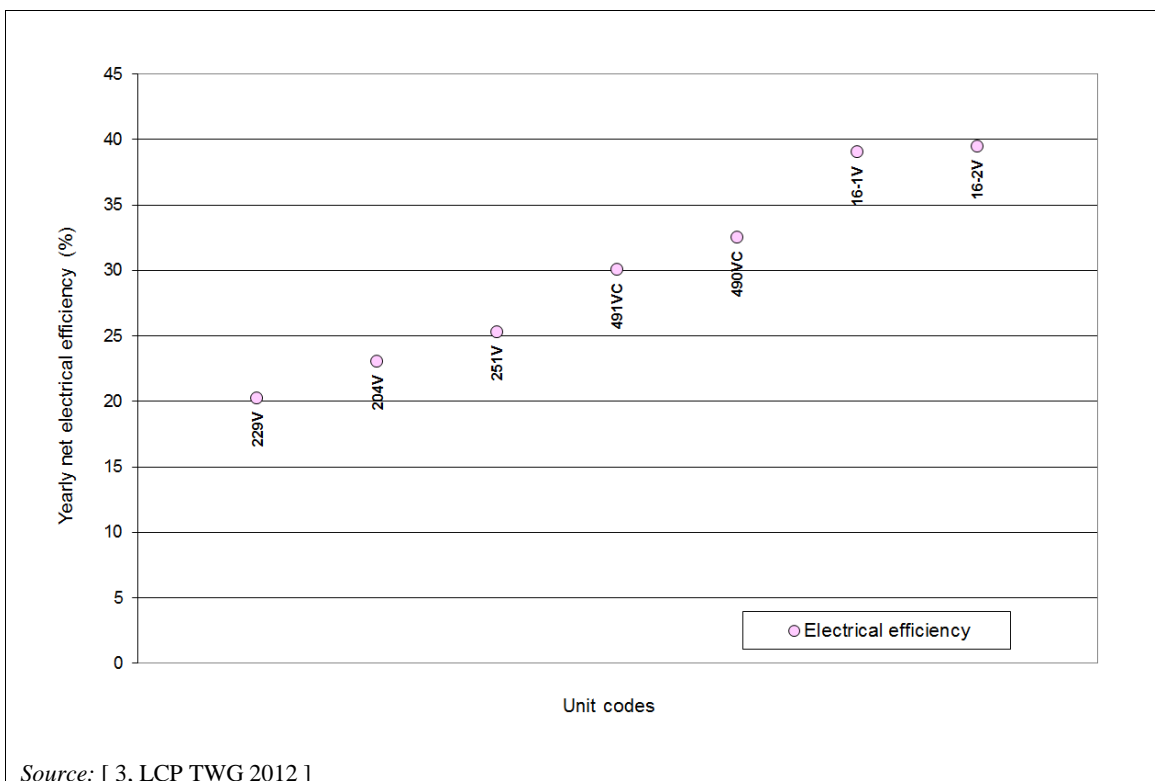

Figure 7.17: Typical net operating electrical efficiencies in 2010 of European natural gas-fired open-cycle gas turbines

Figure 7.18 and Figure 7.19 show the operating electrical efficiencies of some example European combined-cycle gas turbines combusting natural gas and providing heat and power. These units have been designed primarily for producing an industrial or domestic heating fluid. Therefore, their electrical efficiency is lower than for CCGTs only producing power. Furthermore, a distinction can be made between two groups of plant sizes: between $50 \text{ MW}_{\text{th}}$ and $600 \text{ MW}_{\text{th}}$, and above $600 \text{ MW}_{\text{th}}$. The overall fuel utilisation depends on the heat demand and on the type of activity.

Figure 7.18 shows the operating energy efficiency of CCGT CHP units between $50 \text{ MW}_{\text{th}}$ and $600 \text{ MW}_{\text{th}}$ that are operated generally for more than 4 000 h/yr, with an equivalent full load factor between 55 % and 93 %. They achieve yearly air emission concentrations below 75 mg/Nm^3 for NO_x and in general below 30 mg/Nm^3 for CO. These plants were commissioned between the mid-1990s and 2011, and operate in different sectors, such as the pulp and paper, food and drink, and chemical industries, or for energy generation for power and district heating.

As the electrical efficiencies of similar plants of a larger size appear to be slightly different, they are presented separately. Plant 74 has undergone modifications in the gas turbine parts design (installation of internal brush seals), allowing a thermal energy improvement of 2 percentage points.

shows the operating energy efficiency of CCGT CHP units of more than 600 MW_{th} that are operated more than 4 000 h/yr, with an equivalent full load factor above 70 %, achieving yearly air emission concentrations in general below 32 mg/Nm³ for NO_x and below 5 mg/Nm³ for CO. These plants were commissioned between 2000 and 2011 and operate as CHP plants in industrial sectors, such as the chemical industry or for power and district heating. As the electrical efficiencies of similar plants of a smaller size appear to be slightly different, they are presented separately.

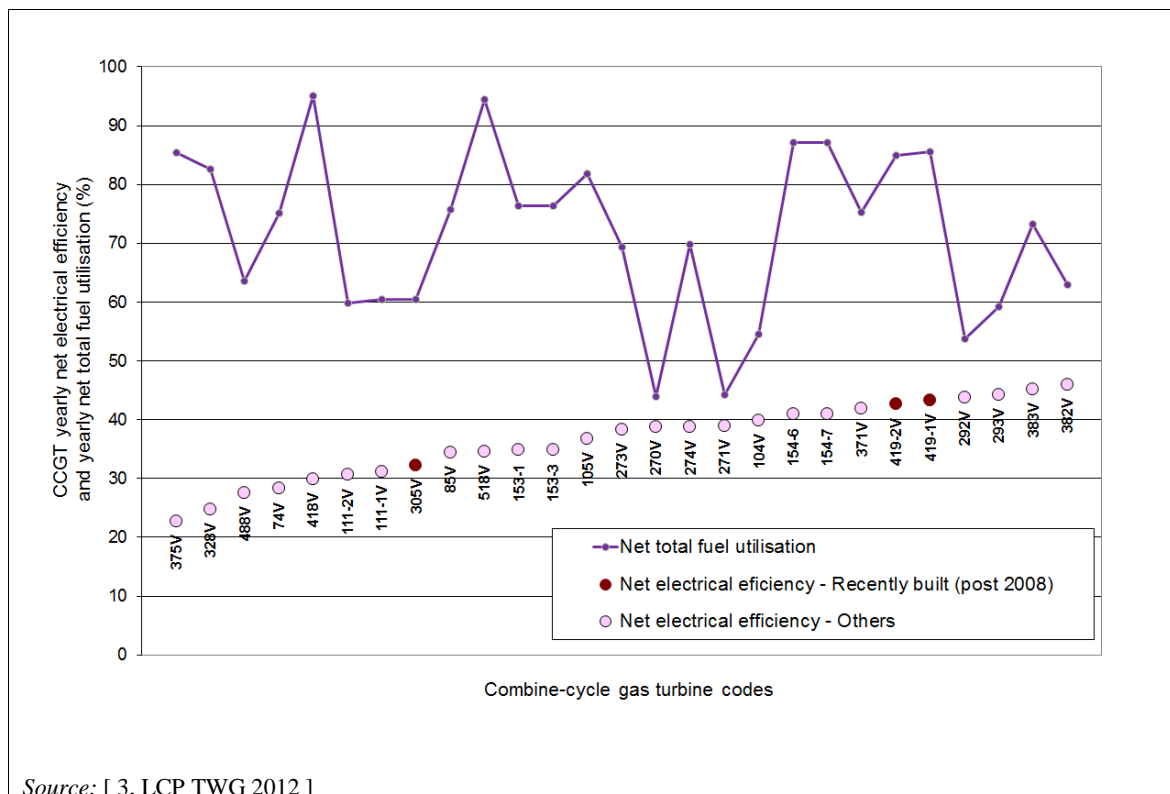

Source: [3, LCP TWG 2012]

Figure 7.18: Typical net operating energy efficiencies in 2010 of European natural-gas-fired combined-cycle gas turbines producing heat and power (plants from 50 MW_{th} to 600 MW_{th})

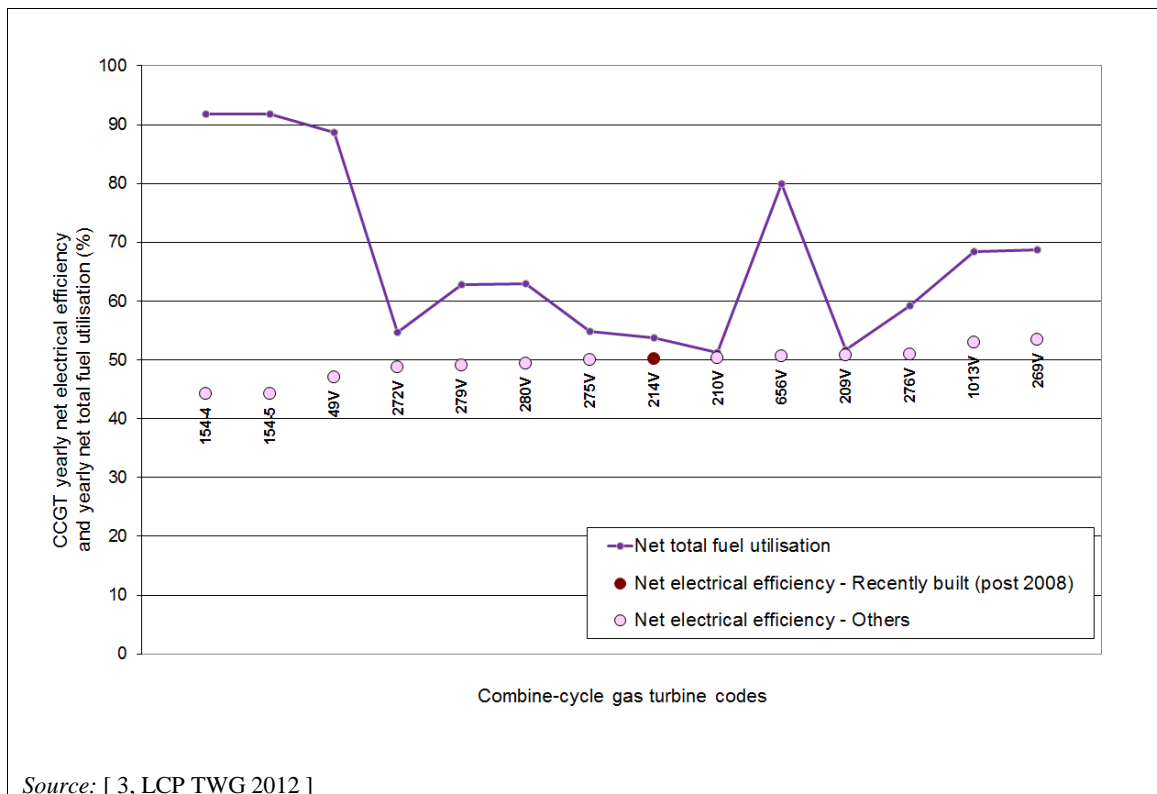

Source: [3, LCP TWG 2012]

Figure 7.19: Typical net operating energy efficiencies in 2010 of European natural-gas-fired combined-cycle gas turbines producing heat and power (plants of > 600 MW_{th})

As previously mentioned, plants only producing electricity have a net operating electrical efficiency generally higher than CHP plants. Figure 7.20 shows yearly net operating electrical efficiencies at European CCGTs, for recently built plants (therefore with an expected improvement in terms of the materials used in the flow path design) and for those fitted with a double steam reheat system in order to improve the steam parameters. These plants have a rated thermal input above 350 MW_{th}, except for Plants 295-296 (235 MW_{th}). They operate in variable load modes between 1 100 h/yr and > 8 000 h/yr, with an equivalent full load factor between 29 % and 99 %. They generally achieve yearly air emission concentrations below 55 mg/Nm³ for NO_x and below 5 mg/Nm³ for CO. They were commissioned between the early 1990s and 2011 and are generally used to provide power to the electricity grid (one plant provides power to a chemical site). It should be noted that Plants 295-296 operate for less than 2 000 h/yr and have numerous start-up and shutdown periods (250 h/yr), and that Plant 241 is a peak load plant operated only 121 h/yr. These plants also have higher CO emission levels (up to 50 mg/Nm³) than the others.

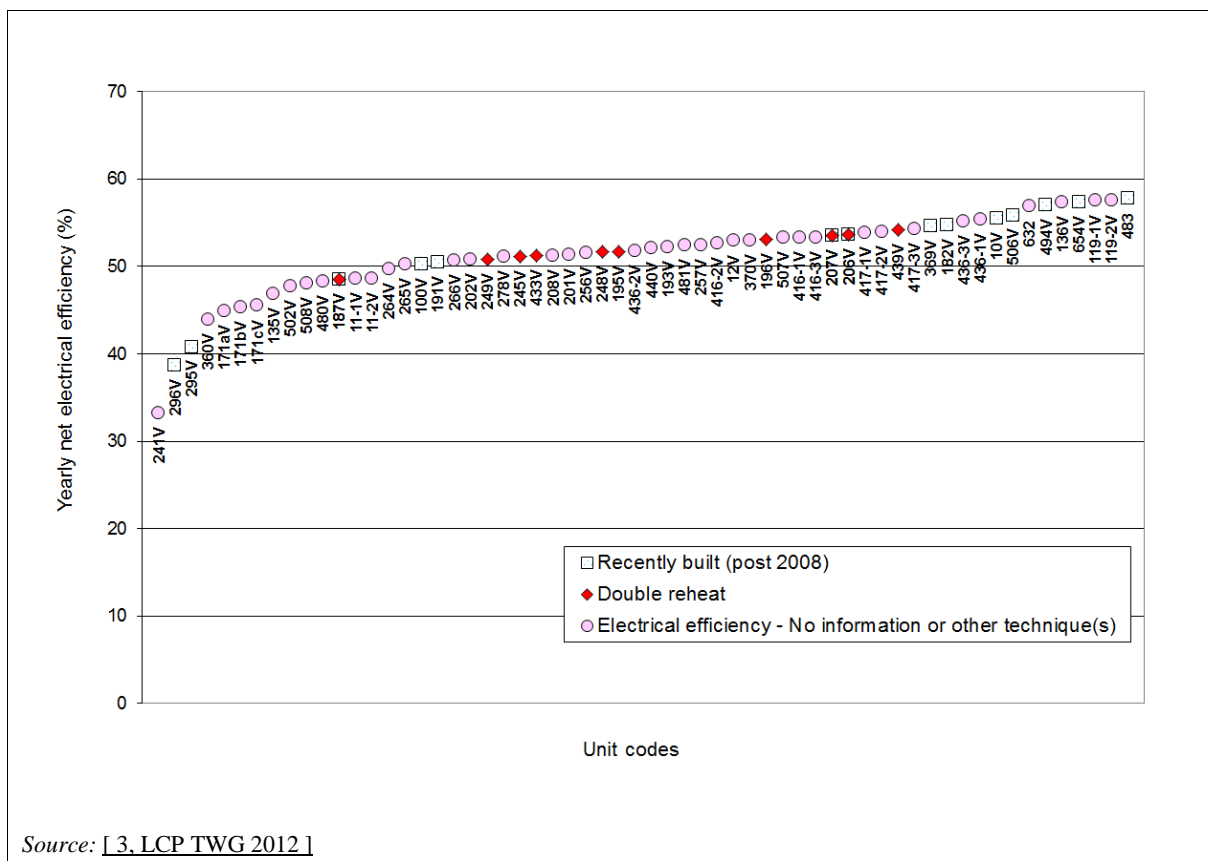

Source: [3, LCP TWG 2012]

Figure 7.20: Typical net operating electrical efficiencies in 2010 of European natural-gas-fired combined-cycle gas turbines producing power only

For gas boilers, it is more appropriate to assess the net total fuel utilisation instead of the net electrical efficiency, as most of them are utility boilers. Figure 7.21 shows the reference values for European plants sized between 20 MW_{th} and 450 MW_{th}, operating between 70 h/yr and > 8 000 h/yr, with an equivalent full load factor between 12 % and 92 %. They were commissioned between 1966 and 2008.

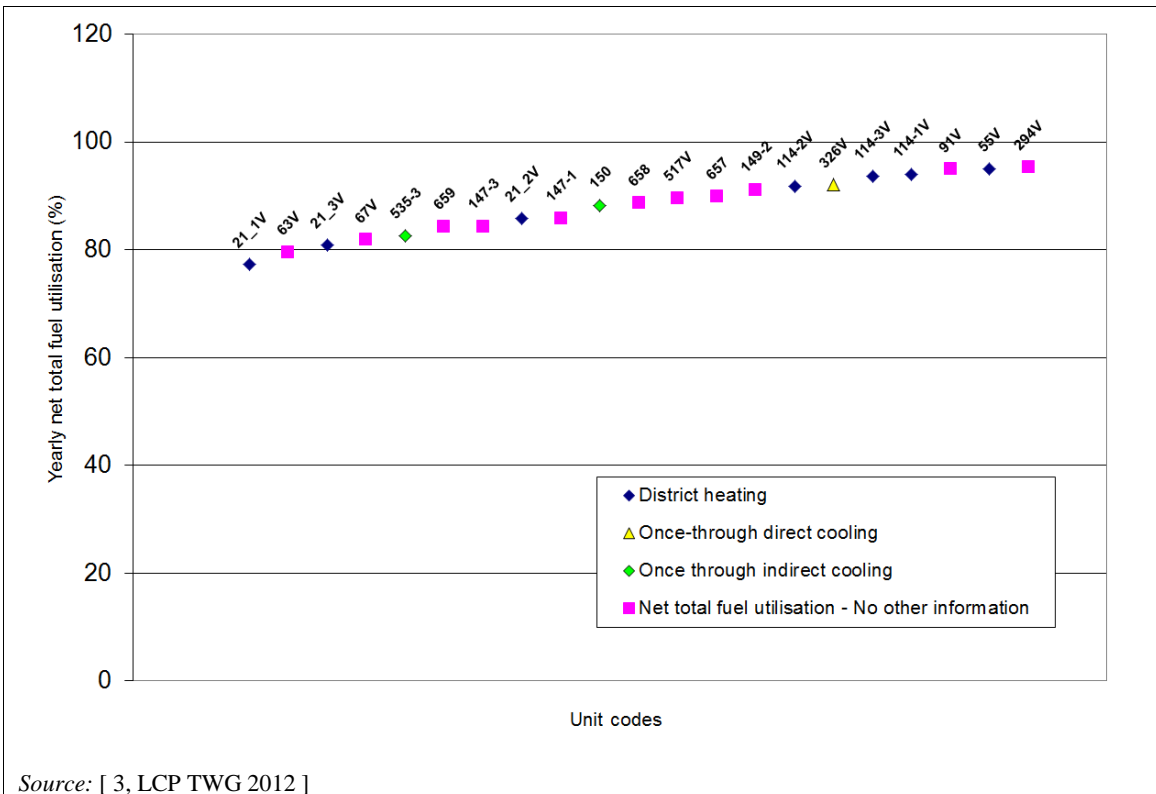

Source: [3, LCP TWG 2012]

Figure 7.21: Typical operating net total fuel utilisation in 2010 of European natural-gas-fired boilers

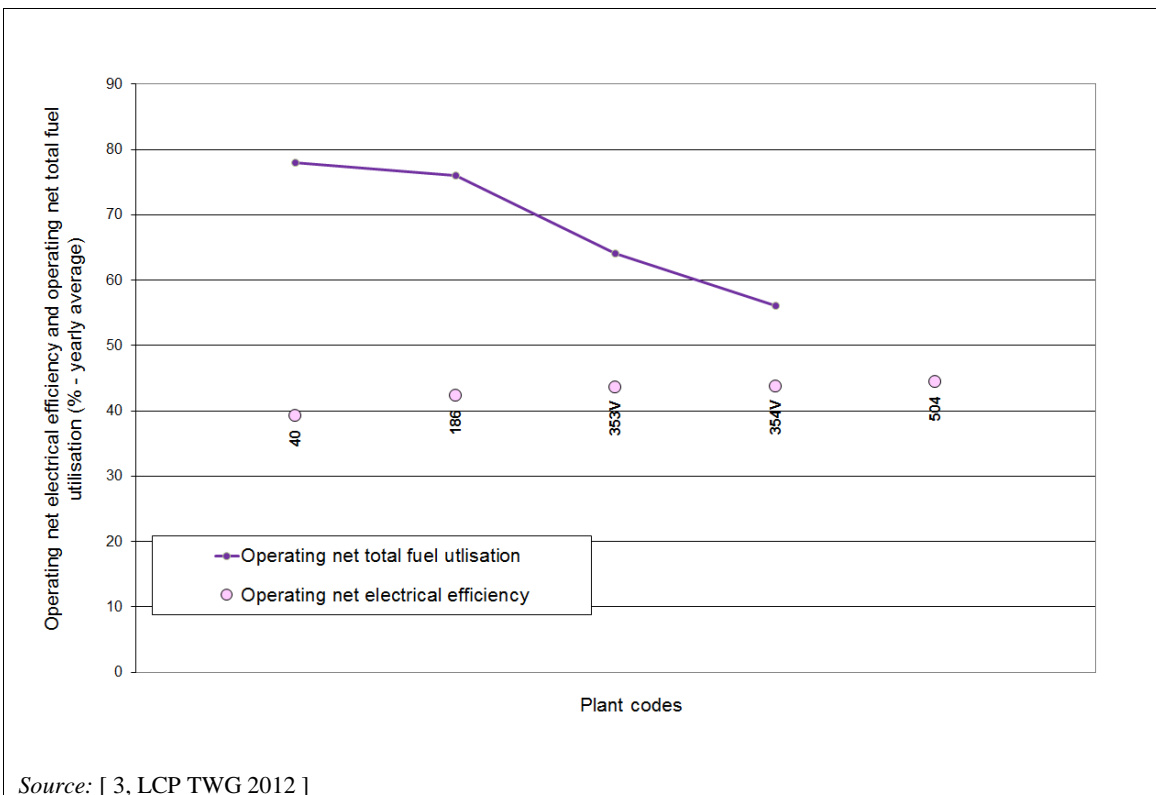

Source: [3, LCP TWG 2012]

Figure 7.22: Typical net operating energy efficiencies in 2010 of European natural-gas-fired engines

In addition to these operating levels, information was submitted on net design energy efficiency levels:

- In the case of mechanical drive uses, net design mechanical efficiencies of between 25 % and 41 % were reported from a set of 19 plants. With the exception of two plants with efficiency levels of 25 % and 29 %, all the others have efficiency levels above 33.5 %. Example plants commissioned more recently are able to achieve levels higher than 36.5 % (e.g. Plants 335, 336, 341).
- In the case of open-cycle gas turbines, net design electrical efficiencies between 33 % and 41.5 % were reported by two plants.
- In the case of CCGTs producing power only, net design electrical efficiencies between 47 % and 59.7 % were reported from 39 older plants and between 57 % and 60.5 % from three plants commissioned after 2010.
- In the case of CCGT CHP plants, net design total fuel utilisation between 67 % and 89 % were reported from 12 older plants and of 81 % from one plant commissioned after 2010. It should be noted in this case that:
 - operating efficiencies reported in previous figures are sometimes more comprehensive than this data set;
 - in the case of plants more oriented towards electricity production, the same design net electrical efficiencies are expected as for plants producing electricity only;
 - it may happen that the potential local demand for heat is too low to achieve high levels of net design total fuel utilisation.
- CCGTs sized between 50 MW_{th} and 600 MW_{th} are slightly less efficient than those larger than 600 MW_{th}.
- Four boilers reported a net design total fuel utilisation between 87 % and 95 %.
- The engine Plant 186-1 reported a net design total fuel utilisation of 84.5 %

[66, TWG Task Force on Energy Efficiency 2014]

7.1.3.1.2 Specific techniques to increase the energy efficiency of the fuel supply and handling activities

7.1.3.1.2.1 Use of an expansion turbine

Description

Use of an expansion turbine (turbo expander) to recover energy from the pressurised supplied fuel.

Technical description

A turbo expander is installed on the natural gas supply line (instead of a classical throttling valve) to recover power from the expansion of the high pressure natural gas to the supply pressure of the gas turbine or gas engine plant. The throttling valve is kept as back-up, in case the turbo expander is not available.

Achieved environmental benefit

Improvement of a plant's overall energy efficiency, by recovery of the energy that would be lost if a classical throttling valve was used.

Environmental performance and operational data

High operational experience.

The following operational data regarding the turbo expander are reported from a 460 MW_{th} plant in Belgium:

- Nominal gas flow: 86 000 Nm³/h.
- Produced power: 2580 kW.
- Technical data:
 - High-pressure part:
 - Rotation speed: 14 350 rpm;
 - Inlet pressure: 74.5 bar;
 - Inlet temperature: 72 °C;
 - Outlet pressure: 38.5 bar;
 - Outlet temperature: 30.1 °C;
 - Low-pressure part:
 - Rotation speed: 14 350 rpm;
 - Inlet pressure: 38.3 bar;
 - Inlet temperature: 54 °C;
 - Outlet pressure: 18.5 bar;
 - Outlet temperature: 15.1 °C.

Cross-media effects

Safety issues need to be considered.

Technical considerations relevant to applicability

The temperature of the gas at the input of the turbine has to be higher than in a classical throttling valve because the temperature drop is greater in a turbo expander (the efficiency depends on the pressure drop) and the risk of condensation in the expansion turbine needs to be avoided. For this reason, the gas needs to be preheated before the expansion.

Economics

Payback time of around five years.

Driving force for implementation

Optimal efficiency of the power plant.

Example plant

Combustion Plants 11-1 and 11-2. [3, LCP TWG 2012]

Reference literature

No information provided.

7.1.3.1.3 Specific techniques to increase the energy efficiency of natural-gas-fired turbines

7.1.3.1.3.1 CHP readiness

Description

Flexibility in the combustion plant design can allow for further easy modifications to be applied, for example for implementing a heat generation system at a plant producing electricity only.

Technical description

New power-only CCGTs (i.e. those which are not initially built with CHP, for instance due to the lack of established heat networks) can include sufficient flexibility in their design to allow adaptation to supply heat at a later stage. Plants built according to this principle are said to be 'CHP-ready' (CHPR), and 'CHP-lockout' (where the design precludes the later extraction of heat) is avoided.

Achieved environmental benefits

Improved overall thermal efficiency over the mid to long term.

The degree to which any new CCGT power station is CHPR will be location-specific, based on the current and potential future heat supply opportunities in that particular area.

Environmental performance and operational data

See CHP technique (Section 3.2.3.2).

Cross-media effects

None.

Technical considerations relevant to applicability

Applicable to new CCGTs.

The exact method of steam extraction depends to a large extent on the design of a plant's steam turbine(s). In all cases, there are limits to the amount of low-pressure steam which can be extracted before further modifications are required; for example, re-blading of the low-pressure section of the steam turbine (ST) may be needed to compensate for lower flows and/or new ST casings may be needed to allow steam extraction from the turbine itself.

Technical and space requirements have to be assessed, including the following:

- The steam extraction points need to be identified and sufficient space provided for access and for pipe runs. These points do not necessarily have to be fitted with the required flanges, valves and pipes from the outset, but it must be possible to fit them at a possible later stage.
- The plant systems and control and instrumentation systems should be suitable for later upgrades, in order to accommodate the extra plant needs associated with heat supply.
- The water treatment and the demineralisation plant may need to be increased in size, if steam is to be piped off site without condensate return.
- If the retrofit of a back-pressure turbine is identified as part of the requirements for the heat supply, then due consideration needs to be given to how this will be integrated electrically and how the condensate will be returned.
- The space needed for a heat exchanger or for an extra water demineralisation stage, if the steam is to be piped off site without condensate return.
- The space needed for back-up boilers to supply heat in the event that the CCGT is off-line. Also, space may need to be reserved for the later fitting of a back-pressure turbine, if applicable.

Economics

The efficiency of the CHP scheme should be sufficient to achieve at least a 10 % reduction in primary energy usage, compared to the separate generation of the heat and power produced to be considered highly efficient according to Directive 2012/27/EU. For such a comparison, the primary energy savings (PES) can be calculated according to the following equation provided in the Energy Efficiency Directive 2012/27/EU:

$$PES = \left[-1 - \frac{1}{\frac{CHPH_{\eta}}{Ref H_{\eta}} + \frac{CHPE_{\eta}}{Ref E_{\eta}}} \right] \times 100$$

where:

CHP H_{η} is the heat efficiency,

CHP E_{η} is the electrical efficiency,

Ref H_{η} is the reference heat efficiency,

Ref E_{η} is the reference electrical efficiency.

The cost associated with making a newbuild power plant CHP-ready may be significant. This would be a function of many factors, including operational expenditure such as fuel costs associated with suboptimal thermal efficiency prior to connection of the heat load as well as front-end capital costs associated with purchasing bespoke equipment rather than plant suppliers' more standardised designs. However, any forecast of the potential future heat supply opportunities has uncertainties and care is needed to avoid over- or under-estimating this potential. In any case, there remains the risk that this could a) trigger plant inefficiency by providing a CHP option that the potential future market is unlikely to call on in part or in full, and b) incur over its life cycle economic losses for no material or environmental gain.

Driving force for implementation

Directive on Energy Efficiency.

Example plants

No information provided.

Reference literature

[9, UK-TWG 2012]

7.1.3.1.3.2 Flow path optimisation

Description

Aerodynamic optimisation of the entire flow path of the gas turbine system (i.e. between the air inlet and the exhaust gas outlet).

Technical description

For existing plants, internal brush seals can be installed. These are comprised of a pack of fine metallic wires held in a frame. They are installed in different parts of the machine to reduce leakage into the air and hot gas path. A brush seal can easily accommodate a misalignment normally not tolerated by labyrinth designs.

In the retrofit of Plant 74, the modifications were as follows:

- Stage 1 Shrouds (first stage wheel spacer): The original material was changed to improve material strength and allow a more favourable residence time at the adequate temperature. The parts design and seals between parts were changed to considerably reduce the leakage of compressor discharge air into the hot gas path, resulting in an improved gas turbine performance.
- Second and Third Stage Shrouds: New design with honeycomb material. This abradable coating reduces the clearance between the blades and shrouds. Honeycomb shrouds also reduce performance degradation, by maintaining tighter clearances throughout the life of the parts.
- Stage 1 Nozzle (moving blades): The major design change incorporated into the improved cooling, stage 1 nozzle was the addition of a more efficient film-cooling pattern. The seal design was modified (spline seal and chordal hinge improvements) to decrease the leakage into the hot gas path.
- Stage 2 Nozzle: The new second stage nozzle was coated with an aluminide coating to provide improved high-temperature oxidation resistance. Other modifications included

changes to the second stage nozzle's internal core plug. Core plug modifications allow more efficient distribution of the cooling air and reduced nozzle-cooling requirements. Some brush seals were installed on these parts, thus reducing the leakage.

- Stage 2 and 3 Buckets (fixed blades): The blades design incorporated several design improvements to allow for operation at the higher firing temperature, especially new material and new cooling holes. There were also some cutter teeth added to the top of the blades. This allowed cutting of the shrouds' abradable material.

Achieved environmental benefits

Increased thermal efficiency and power output.

Environmental performance and operational data

Implementing internal brush seals can improve the power output by 2.75 percentage points and the efficiency by 2 percentage points.

Cross-media effects

None.

Technical considerations relevant to applicability

Generally applicable to new and existing plants.

Economics

- Low cost when included at the design stage for new plants.
- Reported cost for Plant 74: EUR 3.9 million.

Driving force for implementation

No information provided.

Example plants

Combustion Plant 74 (open-cycle gas turbine).

Reference literature

No information provided.

7.1.3.1.3.3 Inlet combustion air cooling

Description

Cooling the gas turbine inlet air can increase the power output and energy efficiency of the gas turbine by converting it into denser air, giving the gas turbine a higher mass flow rate and reducing the energy needed for its compression by the compressor.

Technical description

There are two basic systems currently available for inlet cooling: evaporative cooling (the most cost-effective but limited by the wet-bulb temperature) by evaporating the water contained in the inlet air, and heat exchange or chilling by heat exchangers in the inlet combustion air duct. When choosing the cooling system to be implemented, the reduction of cooling air consumption by the use of efficient cooling technologies, e.g. convection cooling/impingement method, film cooling, and transpiration cooling, should also be considered.

presents the behaviour of a simulated open-cycle gas turbine where implementation of the two cooling systems is studied. In this graph, ϕ is the ambient relative humidity and the base case represents the gas turbine without any inlet air cooling system. This graph shows that the chilling method provides a higher thermal efficiency at higher ambient temperatures, and that the evaporative cooling method provides a higher thermal efficiency when the ambient intake temperature is lower than 20 °C.

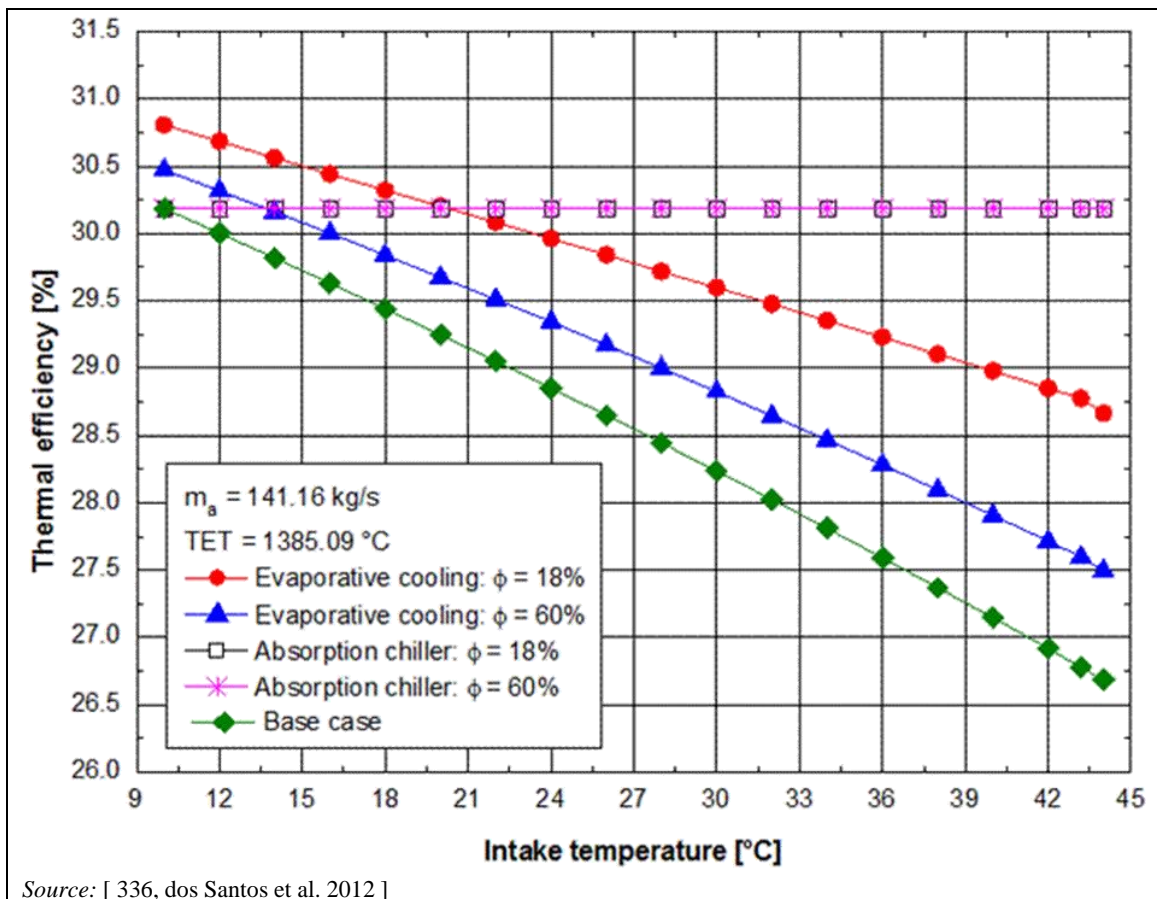

Figure 7.23: Effect of ambient intake temperature on the gas turbine thermal efficiency using evaporative and absorption chiller cooling

Achieved environmental benefits

Increased thermal efficiency.

Environmental performance and operational data

High operational experience.

Cooling the inlet air can enable an electrical efficiency increase of about 0.1 percentage point per degree Celsius in hot weather conditions.

Cross-media effects

None.

Technical considerations relevant to applicability

Generally applicable to new plants.

Economics

- Low capex.
- Depends on the implemented technology: the relative costs vary from a factor of 1 (evaporative cooler) to 10 (two-stage lithium-bromide absorption chiller).

Driving force for implementation

Output increase for regions where significant power demand and highest electricity prices occur during the warm months.

Example plant

Combustion Plant 292.

Reference literature

[46, dos SANTOS et al. 2012] [47, Donaldson Company 2005]

7.1.3.1.3.4 Recuperative gas turbine cycle

Description

Flue-gas heat recovery in order to preheat the combustion air in simple-cycle gas turbines.

Technical description

The gas turbine cycle efficiency can be improved by modifying the simple cycle to recover heat from the gas turbine exhaust by the addition of a regenerator (heat exchanger), where the exhaust flow preheats the compressor discharge air prior to combustion.

There are several possibilities involving heat recirculation for improving the energy efficiency of gas turbines: location of the heat recuperator between the HP and LP turbines, known as ARC (alternative recuperation cycle), or on the flue-gas duct, known as CRC (conventional recuperative gas cycle).

Achieved environmental benefits

Increased thermal efficiency.

Environmental performance and operational data

There is an example of a 4.6 MW_{th} Solar Mercury 50 gas turbine achieving 38.5 % electrical efficiency. Such units can, in CHP applications, achieve 70 % fuel utilisation without supplementary firing, and 90 % fuel utilisation with supplementary firing.

Implementation at an old 60 MW_{th} gas turbine in Iran with a low electrical efficiency (26 %) enabled an electrical efficiency increase of 1.7 percentage points.

Cross-media effects

No information provided.

Technical considerations relevant to applicability

Many of the new efficient gas turbines have a high pressure ratio giving a high compressor discharge temperature and low gas turbine flue-gas temperature. It is therefore not generally possible to transfer heat from the exhaust gas to the compressor discharge airflow for modern gas turbines. This technique applies then to gas turbines with a low to moderate pressure ratio.

Economics

Plant-specific.

Driving force for implementation

No information provided.

Example plants

No information provided.

Reference literature

[48, Sayyaadi et al. 2012]

7.1.3.2 Techniques to prevent and/or control of NO_x and CO emissions

7.1.3.2.1 General techniques for the prevention and control of NO_x and CO emissions from natural-gas-fired boilers

Information on general techniques for the prevention and control of NO_x, CO and NH₃ emissions is given in Section 3.2. Table 7.10 and Table 7.11 give information specific to natural-gas-fired boilers, e.g. on environmental performances and example plants.

Table 7.10: General techniques for the prevention and control of NO_x and CO emissions from natural-gas-fired boilers

Technique	Technical description	Achieved environmental benefits	Environmental performance and operational data	Cross-media effects	Technical considerations relevant to applicability		Example plants
					New plants	Existing plants	
Low excess air	Introducing air into the combustion chamber in a substoichiometric ratio - see Section 3.2.2.3.1	Reduction of NO _x and increased efficiency	High operational experience	NA	Generally applicable	Generally applicable	NA
Reduction of the combustion air temperature	See Section 3.2.2.3.4	Reduction of NO _x	NA	Decreased energy efficiency	Generally applicable within the constraints associated with the process needs		NA
Advanced control system	This technique is often used in combination with other techniques or may be used alone for combustion plants operated < 500 h/yr - see also Section 3.2.3.8	Reduction of NO _x	High operational experience	None	Generally applicable	The applicability to old units may be constrained by the need to retrofit the combustion and/or control command system(s)	NA
Flue-gas recirculation (FGR)	See Section 3.2.2.3.3	Reduction of NO _x	High operational experience	NA	Generally applicable	Generally applicable	FGR has been retrofitted in a lot of different situations. Example plants commissioned in the 1980s/90s in different industrial sectors, and even one plant commissioned in 1959 in the oil refining sector (Plant 67), report using FGR (e.g. Plants 67, 325), including plants operated < 500 h/yr (e.g. Plant 203)

Low-NO _x burners (LNB)	See Section 3.2.2.3.5. The technique includes ultra-low-NO _x burners (ULNBs)	Reduction of NO _x	High operational experience	NA	Generally applicable	Applicability may be limited for some older plants, in general < 50 MW _{th} , where the flame length of modern low-NO _x burners is incompatible with the boiler design	25 plants out of the 32 gas-fired boilers that submitted information for the BREF review report the use of (U)LNBs. These existing plants belong to very different industries (oil refining, chemical industry, district heating, food and drink, power, pulp and paper industries). Example medium plants of down to 15 MW _{th} were retrofitted with LNBs (e.g. Plant 65 first commissioned in 1974)
Air staging	See Section 3.2.2.3.2	Reduction of NO _x	High operational experience	NA	Generally applicable	Applicability may be limited for very old, small boilers (< 50 MW _{th}) due to lack of height or limited residence time for the complete burnout	Plants 513, 288
Fuel staging	See Section 3.2.2.3.5	Reduction of NO _x	High operational experience	NA	Generally applicable	Generally applicable	Plants 215, 657
Steam/water addition	See Section 3.2.2.3.10	Reduction of NO _x	NA	NA	Generally applicable	Generally applicable	NA
Selective non-catalytic reduction (SNCR)	See Section 3.2.2.3.12. The combination with a 'slip' SCR technique can help complete the NO _x reduction process if the residence time is not long enough	Reduction of NO _x	Example plant with NO _x reduction between 72 % and 91 % applying SNCR + in-duct SCR	Ammonia slip – safety issue related to ammonia storage (e.g. in residential areas)	Generally applicable	Generally applicable	NA
					Not applicable to combustion plants operated < 500 h/yr with highly variable boiler loads. The applicability may be limited in the case of combustion plants operated between 500 h/yr and 1 500 h/yr with highly variable boiler loads		

Selective catalytic reduction (SCR)	See Section 3.2.2.3.11. This technique can also be used in a 'reduced' form in combination with SNCR, at a global cost lower than if using a full SCR system	Reduction of NO _x	High operational experience. Example plant with NO _x reduction between 72 % and 91 % applying SNCR + in-duct SCR	Ammonia slip – safety issue related to ammonia storage (e.g. in residential areas), CO ₂ increase, waste generation	Generally applicable	There may be technical and economic restrictions to the retrofitting of existing plants operated between 500 h/yr and 1 500 h/yr	NA
<p>NB: NA: No relevant specific information available. Source: [27, ICAC 2009]</p>							

Environmental performance and operational data for NO_x emissions from well-performing natural-gas-fired boilers

Figure 7.24 gives an overview of NO_x emissions from well-performing European boilers when applying techniques mentioned in The reported boilers are in general sized between 20 MW_{th} and 300 MW_{th}, except Plant 203V (800 MW_{th}). They are operated in different load modes, from < 500 h/yr (Plants 21-1V and 21-2V) to ≥ 4 000 h/yr (Plants 63V, 67V, 149-2, 513V, 517V and 657), with an equivalent full load factor (EFL) between 9 % (Plant 535-3) and more than 90 % (Plant 21-2V). Yearly CO air emission concentrations are generally below 15 mg/Nm³. These plants were commissioned between 1966 (Plant 535V) and 2011 (Plant 215V). The combination of primary NO_x techniques in the graph means that at least two of the following techniques are implemented at each of the plants: LNB, flue-gas recirculation, air staging or fuel staging. These plants belong to different sectors and most of them continuously monitor their NO_x and CO emissions. The short-term (half-hourly to twice daily) averages provided range from 45 mg/Nm³ to 165 mg/Nm³ over a year (5th to 95th yearly percentiles). Plant 67V (88 MW_{th}) was retrofitted with a LNB and includes flue-gas recirculation. The emission level before retrofit was 480 mg/Nm³. The achieved NO_x reduction efficiency is 88.5 %. The case of Plant 91V is specific as it is fitted with combustion air preheating. This plant uses mainly LNB and load limitation (EFL of 40 %) for limiting NO_x emissions.

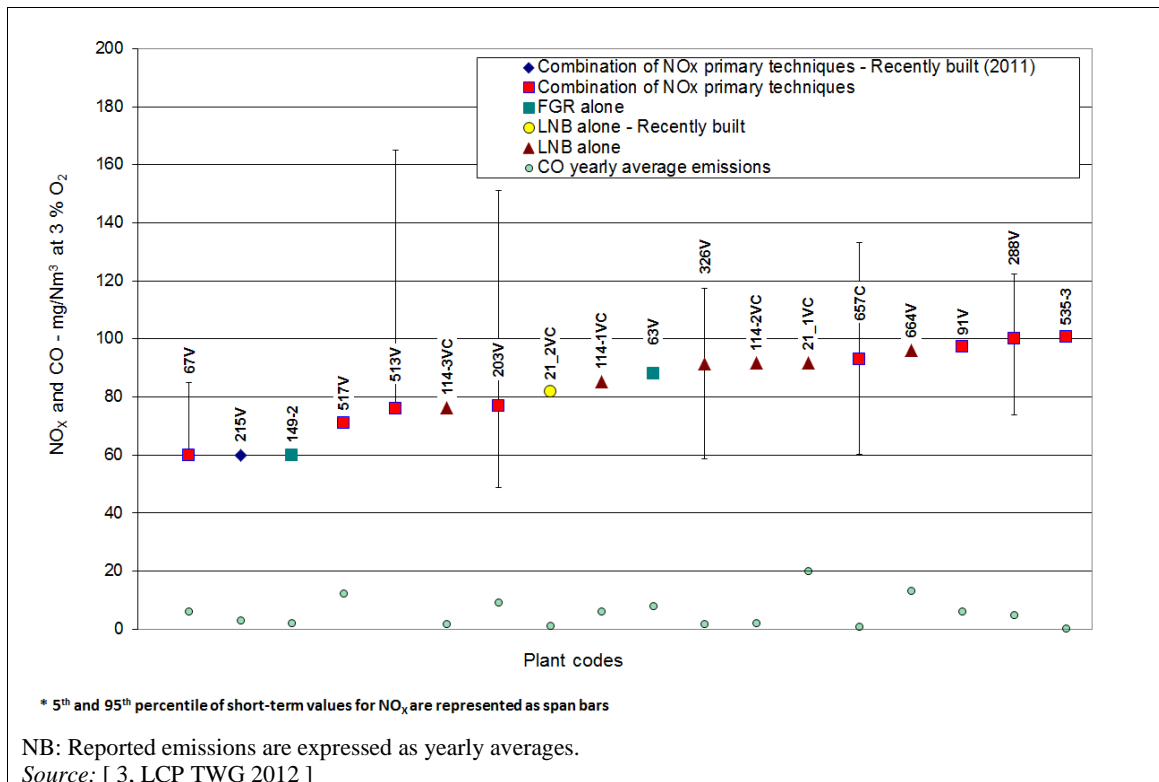

Figure 7.24: NO_x emissions to air in 2010 from well-performing European boilers

The latest generation of ultra-low-NO_x burners enables the achievement of NO_x emission levels below 30 mg/Nm³ for hundreds of plants in the US [244, COEN 2012] down to 10 mg/Nm³ at 3 % O₂ where the regulations are more stringent, and may therefore represent efficient techniques both for new plants and to retrofit existing plants.

7.1.3.2.2 General techniques for the prevention and control of NO_x and CO emissions from natural-gas-fired turbines

Information on general techniques for the prevention and control of NO_x, CO and NH₃ emissions is given in Section 3.2.2.3. Table 7.11 to Table 7.13 and Figure 7.25 to Figure 7.30 give information specific to natural-gas-fired turbines, e.g. on environmental performances, economics and example plants.

Table 7.11: General techniques for the prevention and control of NOX and CO emissions from natural-gas-fired turbines

Technique	Technical description	Achieved environmental benefits	Environmental performance and operational data	Cross-media effects	Technical considerations relevant to applicability		Economics	Example plants
					New plants	Existing plants		
Direct steam injection	See Section 3.2.2.3.10	Reduction of NO _X	High operational experience	Possible increase in material stress	Not applicable in remote areas without access to water	Applicable only in CHP CCGTs, not in simple GTs. The applicability may be limited due to water availability	NA	NA
Direct water injection		Reduction of NO _X	The performance of these techniques is limited by the water/fuel ratio; DLN allow much lower levels of emissions to be achieved than water/steam injection	Possible increase in material stress			NA	NA
Dry low-NO _X burners	See Section 3.2.2.3.7	Reduction of NO _X	High operational experience	NA	Generally applicable	Retrofit packages are now widely available and only very old GTs cannot be retrofitted. Retrofitting can also be limited in the case of installed steam/water injection systems	In cases where the conversion of old GTs is possible, costs can be very high, up to 50 % of the costs of a new gas turbine	NA
Selective catalytic reduction (SCR)	See Section 3.2.2.3.11 Catalyst solutions are available including for use at OCGTs with high-temperature flue-gases. The temperature window is an important parameter for this technique to operate properly. Different solutions can enable the plant to cope with the temperature such as the use of an SCR bypass when the temperature is too low, the proper location of the SCR system and/or the use of special catalysts [335, ICAC 2009]	Reduction of NO _X	High operational experience	Ammonia slip – safety issue related to ammonia storage (e.g. in residential areas), CO ₂ increase, waste generation	Generally applicable	Applicability may be limited by lack of space. Not generally applicable to plants of < 100 MW _{th}	See Table 7.13 This technique may be costly in the case of plants operated between 500 h/yr and 1 500 h/yr and even more so for plants operated < 500 h/yr	NA

Oxidation catalyst	See Section 3.2.2.7.2	Reduction (conversion) of CO into CO ₂ and of unburnt carbon	Limited operational experience for gas turbines	SO ₃ and NO generation; CO ₂ increase; waste (catalyst) generation	Generally applicable	Applicability may be limited by lack of space, load requirements and sulphur content	High capex Low opex	Plants 162, 164
Cheng steam injection cycle	See Section 3.2.3.3	Simultaneous NO _x reduction and energy efficiency increase	NA	NA	NA	NA	NA	NA
Catalytic combustion	See Section	Reduction of NO _x . No ammonia slip	Catalytic combustor technology was identified in the 2006 LCP BREF as a very promising technology with very low NO _x emissions down to about 5–6 mg/Nm ³ . The technique is so far only commercially available for low-efficiency gas turbines [116, EUTurbines, 2013]	NA	Under development	NA	Investment and maintenance costs in same order as for SCR [116,EUTurbines2013]	NA
Advanced control system	Automatic regulation of the main combustion parameters (air/fuel ratio at each row of the burner, air excess, flue-gas temperature at the combustion chamber outlet, etc.) - see also Section 3.2.3.8	Reduction of NO _x and CO, and energy efficiency increase	High operational experience	None	Generally applicable	The applicability to old combustion plants may be constrained by the need to retrofit the combustion and/or control command system(s)	NA	NA
Combustion optimisation	See Section 3.2.2.7.1	Reduction of NO _x and CO emissions	NA	NA	Generally applicable	NA	NA	NA
Low-NO _x burners for supplementary firing	See Section 3.2.2.3.5	Reduction of NO _x	High operational experience	NA	NA	NA	NA	NA
<p>NA: No relevant specific information available.</p>								

Additional information on economics for applying SCR at a gas turbine

Table 7.12: Typical cost components for applying SCR at a gas turbine

Cost	Percentage share of total investment
Installation: <ul style="list-style-type: none"> • reactor housing • ammonia supply (storage, vaporisation and injection systems) • flue-gas ducting • monitoring and control equipment • electro technical installations • insulation, painting, etc. 	30–40 %
Construction and start-up	20–30 %
Planning, licensing, unforeseen	10 %
First catalyst filling	30 %

Table 7.13: Typical cost figures for applying SCR at a gas turbine

Catalyst volume (operation range 300–360 °C)	0.1 m ³ /MW _{th}
Catalyst price	EUR 10 000/m ³
<i>Source: [116, EUTurbines 2013]</i>	

Related operating costs include the costs for ammonia consumption, steam consumption, electricity consumption, catalyst replacement, maintenance and repair, insurance and taxes, and possibly personnel, administration and catalyst disposal costs. For an 800 MW_{th} CCGT, operating costs are about EUR 300 000/yr for 8 000 operating hours/yr without including the cost due to pressure drop. This would result in EUR 0.2 million per 1 mbar over the whole lifetime, i.e. about EUR 1 million with a typical pressure drop of 5 mbar.

[116, EUTurbines 2013]

A UK cost estimate for retrofitting a gas turbine with SCR is presented in Table 7.14. This case study refers to a 375 MW_e plant being retrofitted with SCR in the HRSG or in a tail-end configuration, operated 6 000 h/yr over a 10-year amortisation period.

[186, UK 2013]

Table 7.14: SCR retrofit costs for a 375 MW_e combined-cycle gas turbine

Technique	NO _x (mg/Nm ³)		Capital cost EUR M	Specific cost		Assumptions / Risks
	Inlet	Outlet		EUR/ t NO _x	EUR/ MWh	
Tail-end SCR	70	14	98	24 700	1.37	<ul style="list-style-type: none"> • Alternative where HRSG cannot accommodate SCR, gas taken from stack and reheated prior to dedicated reactor • Coal figure scaled on flow with -20 % for Balance of Plant (BoP) reduction and + 50 % for tail-end issues (reheat, etc.) • 1 % assumed works power loss • Does not include cost of reheating flue-gas
SCR in HRSG	70	14	15.8– 47.3	4780– 12 100	1.49– 3.77	<ul style="list-style-type: none"> • Capital cost scaled up using data from vendor, not public • 80 % of cost is an assumed figure for boiler modifications • Percentage reduction achievable to single digit ppm • No public domain data for SCR of this nature • 0.5 % assumed works power loss

NB: Costs are in 2011 prices.

Environmental performance and operational data for NO_x emissions from well-performing natural-gas-fired turbines

Figure 7.25 to Figure 7.30 give an overview of NO_x emissions from well-performing European gas turbines when applying techniques mentioned in Table 7.11. These plants have been categorised in homogeneous groups depending on the combustion process used (open- or combined-cycle plants), the purpose of the plant (power production only, combined heat and power with a level of net total fuel utilisation lower or greater than 75 %, mechanical drive, etc.), the operating conditions (from plants operated $\geq 4\,000$ h/yr to plants operated < 500 h/yr) or the plant size. The differences seen between OCGT and CCGT are mainly due to operation regimes and the type of gas turbine rather than any fundamental difference between open and combine cycle. Almost all CCGTs continuously monitor CO and NO_x emissions, generally at loads from the minimum stable load upwards, and not only above 70 % load. The minimum stable load is gas-turbine-dependent and may be much lower than 70 % as a result of recent progress made on this issue by suppliers to accommodate recent electric grid needs, due in particular to the increasing use of intermittent renewable sources (see Section 7.1.3.2.4).

Figure 7.25 shows the emission levels from CCGTs of ≥ 600 MW_{th}. The reported plants are, in general, between 650 MW_{th} and 750 MW_{th} single-shaft (one GT and one steam turbine from one HRSG) or modular designs (e.g. two GTs for one steam turbine from one HRSG), built from the early 1990s to 2011. The reported plants operate between 1 000 h/yr and more than 8 000 h/yr, with an equivalent full load factor (EFL) generally above 70 % (except for Plants 369, 433, 439 and 49 that have an EFL down to 40 %) and CO emissions below 30 mg/Nm³. Only a few of these plants are fitted with SCR, whereas the others use DLN and achieve the same NO_x emission levels. The only reported value for NH₃ slip (Plant 632) is less than 3 mg/Nm³, consistent with the performance declared by SCR suppliers. The short-term (from half-hourly to daily) averages provided range from < 5 mg/Nm³ to about 50 mg/Nm³, over a year (based on 5th to 95th percentiles of short-term averages, with the exception of one 95th percentile reaching 100 mg/Nm³) when using DLN alone or in combination with SCR.

In the large set of plants that reported information, very few plants of $\geq 600 \text{ MW}_{\text{th}}$ have a net total fuel utilisation above 75 %. These plants with a high level of heat supply may have higher NO_x emissions, as shown by the example Plant 49 which achieves a yearly average NO_x emission level of $48 \text{ mg}/\text{Nm}^3$ whilst having an operating net total fuel utilisation of 88.7 %.

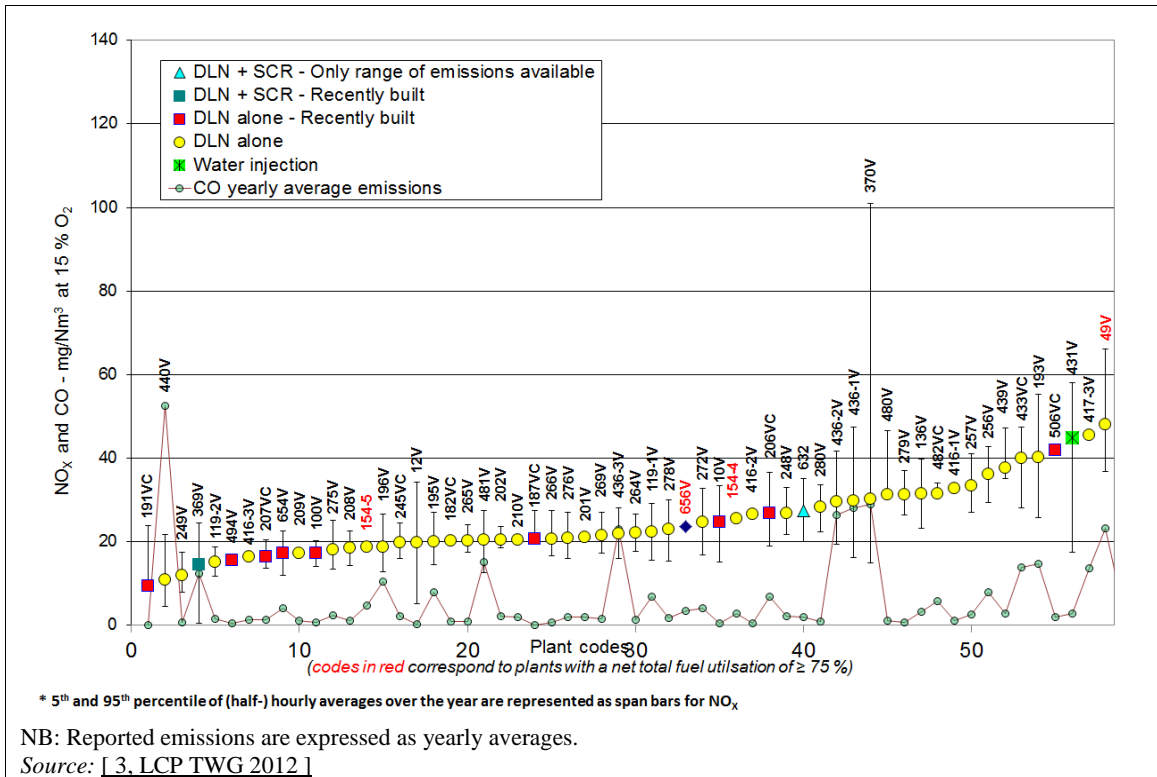

Figure 7.25: NO_x and CO emissions to air in 2010 from well-performing European CCGTs of $\geq 600 \text{ MW}_{\text{th}}$

For smaller CCGTs ($50\text{--}600 \text{ MW}_{\text{th}}$), the level of NO_x emissions can be different when the plants are mainly dedicated to the production of heat instead of electricity, as shown below.

Figure 7.26 and Figure 7.27 provide NO_x emission levels from well-performing European gas turbines sized from $90 \text{ MW}_{\text{th}}$ to about $500 \text{ MW}_{\text{th}}$, built from the early 1990s to 2011, and fitted with DLN, steam/water injection, and/or LNBS for supplementary firing at the HRSG level. The reported plants operate between 1 000 h/yr and more than 8 000 h/yr, with an equivalent full load factor above 45 % and CO emissions in general below $30 \text{ mg}/\text{Nm}^3$. Two separate graphs are presented for plants more dedicated to CHP uses (with a net total fuel utilisation above 75 % in CHP mode) and plants more focused on power generation (with an operating net total fuel utilisation below 75 %). The NO_x emission hourly averages range from $5 \text{ mg}/\text{Nm}^3$ to $58 \text{ mg}/\text{Nm}^3$ within a year (5th to 95th yearly percentiles) for plants with an operating net total fuel utilisation below 75 %, and from $12 \text{ mg}/\text{Nm}^3$ to $100 \text{ mg}/\text{Nm}^3$ for plants with an operating net total fuel utilisation above this level.

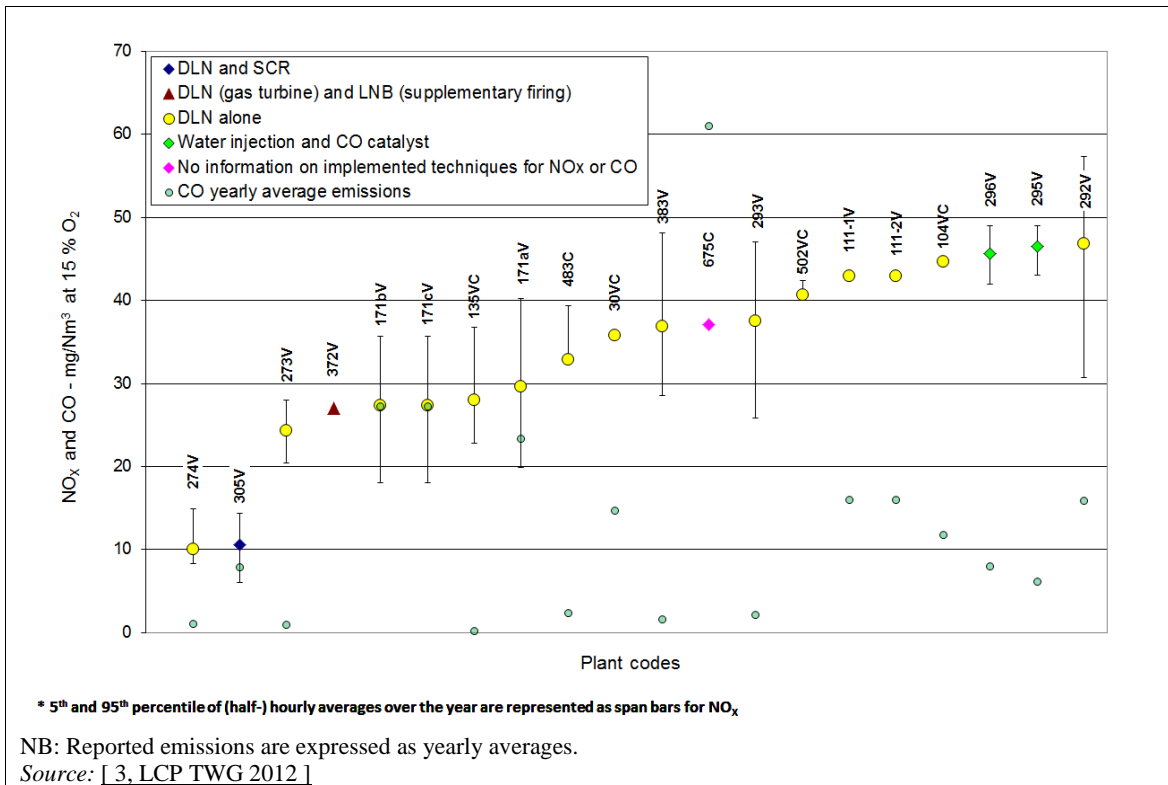

Figure 7.26: NO_x and CO emissions to air in 2010 from well-performing European CCGTs of 50–600 MW_{th} with a net total fuel utilisation of < 75 %

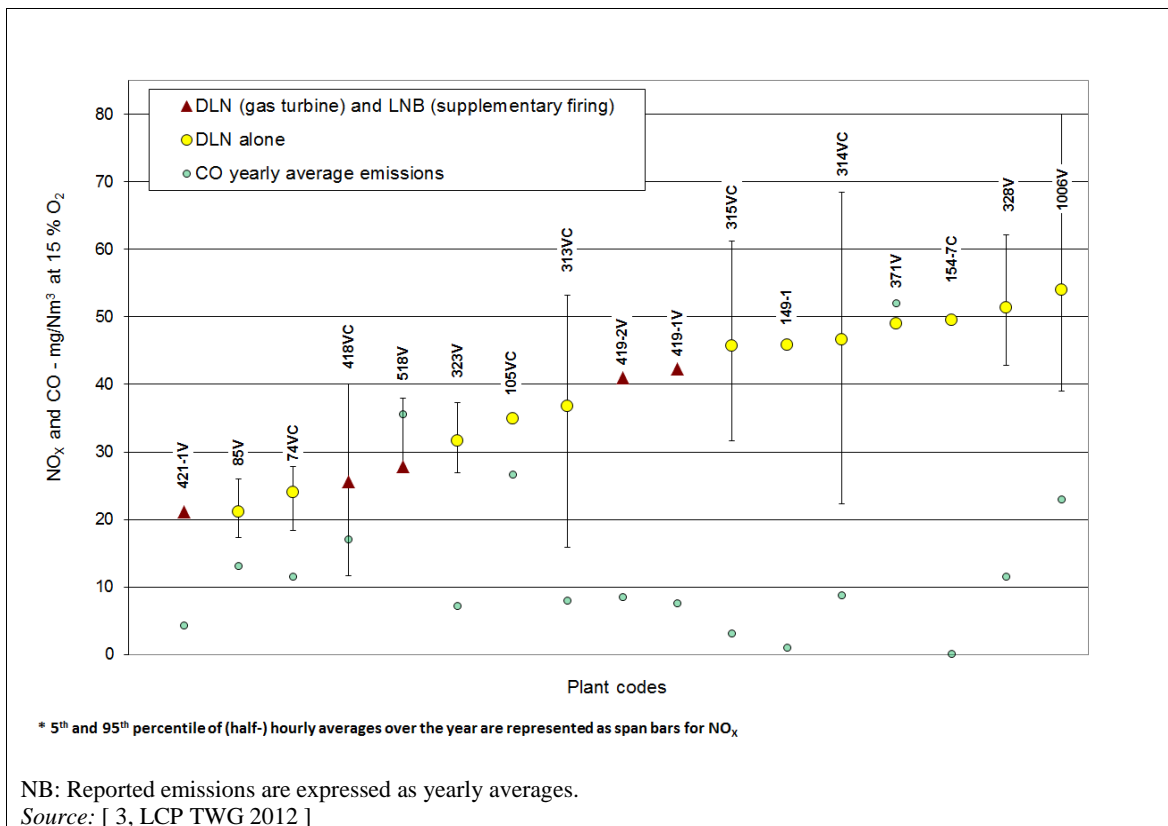

Figure 7.27: NO_x and CO emissions to air in 2010 from well-performing European CCGTs of 50–600 MW_{th} with a net total fuel utilisation of ≥ 75 %

Emission levels achieved by well-performing open-cycle gas turbines combusting natural gas and fitted with DLN are below 50 mg/Nm^3 , as reported by Plants 16-1V and 16-2V (yearly average reported for 2010 of $41\text{--}46 \text{ mg/Nm}^3$) which are open-cycle gas turbines of about $150 \text{ MW}_{\text{th}}$ commissioned in 2008. This kind of plant is usually used for peak load demand, as is the case of Plants 16-1V and 16-2V that are operated between 500 h/yr and $1\,000 \text{ h/yr}$ with an equivalent full load factor above 70% and CO emissions below 40 mg/Nm^3 . The monitoring of NO_x and CO emissions is performed by continuous measurement. The short-term averages range from 20 mg/Nm^3 to 60 mg/Nm^3 over a year (5^{th} to 95^{th} yearly percentiles). Plants 490, 491, and 229, which were commissioned between 1992 and 1997 and are fitted with water injection, are also reported in to illustrate the achievable level of NO_x emissions for this kind of plant, e.g. when DLN cannot be retrofitted and plants are operated $< 1\,500 \text{ h/yr}$.

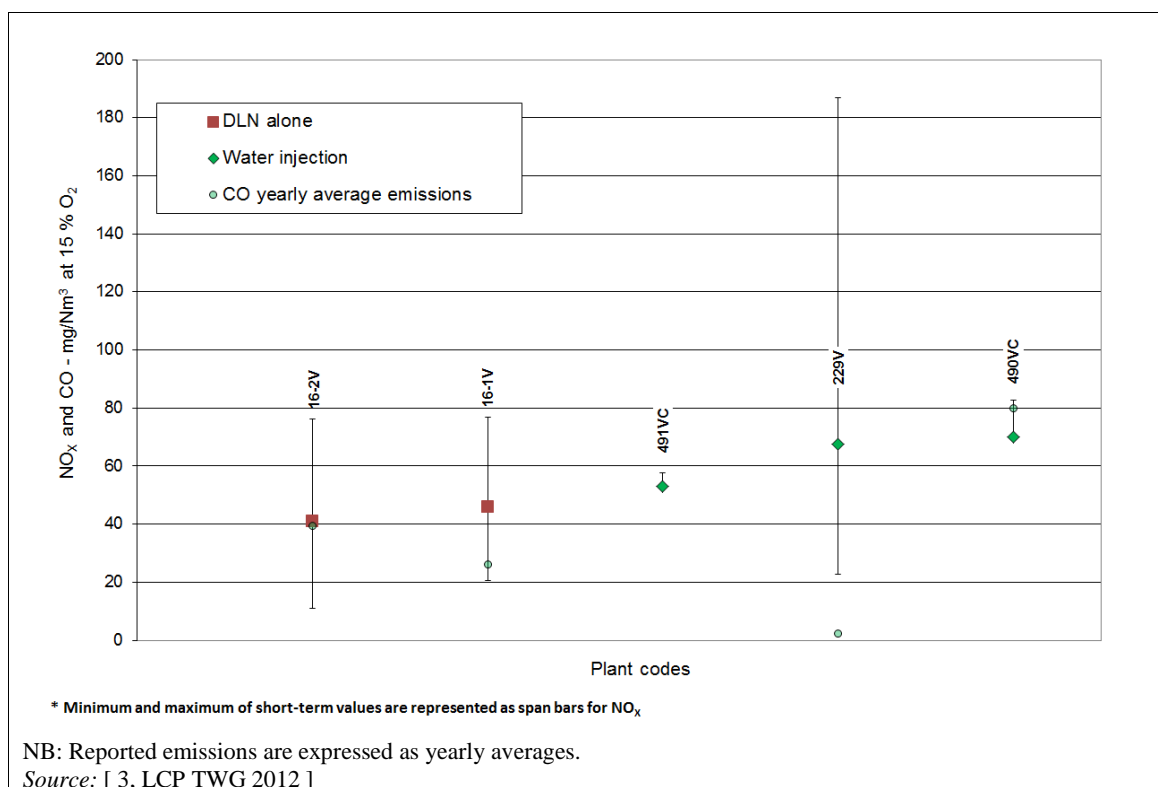

Figure 7.28: NO_x and CO emissions to air in 2010 from European open-cycle gas turbines with the exception of mechanical drive turbines

The turbines used for mechanical drive, mainly for transporting the gas in the European pipelines, are a specific case where the NO_x emissions may be slightly affected due to variations in load demand. Figure 7.29 shows the emissions from this type of plant sized between $13 \text{ MW}_{\text{th}}$ and $75 \text{ MW}_{\text{th}}$ and commissioned between 1997 and 2008, some of them having been retrofitted. The reported plants are operated between 800 h/yr and $8\,200 \text{ h/yr}$, with an equivalent full load factor above 70% even if the load may vary below this level on a hour-to-hour basis depending on the gas customer's demand, with the plant sometimes being operated in the diffusion mode. CO emissions are reportedly below 40 mg/Nm^3 , these plants being fitted with DLN and in one case also with a CO catalyst. For plants above $50 \text{ MW}_{\text{th}}$, the monitoring is mainly performed by continuous measurement or through a predictive emissions monitoring system. Smaller plants mainly perform periodic measurements, and sometimes continuous measurement. In the case of periodic monitoring, the reported data refer to a combustion plant load higher than 70% . In the case of continuous monitoring, the reported data refer to a combustion plant load equal to or higher than the minimum stable load. Short-term averages range from 5 mg/Nm^3 to 67 mg/Nm^3 over a year (maximum of half-hourly, hourly or daily averages, or of samples performed over one year).

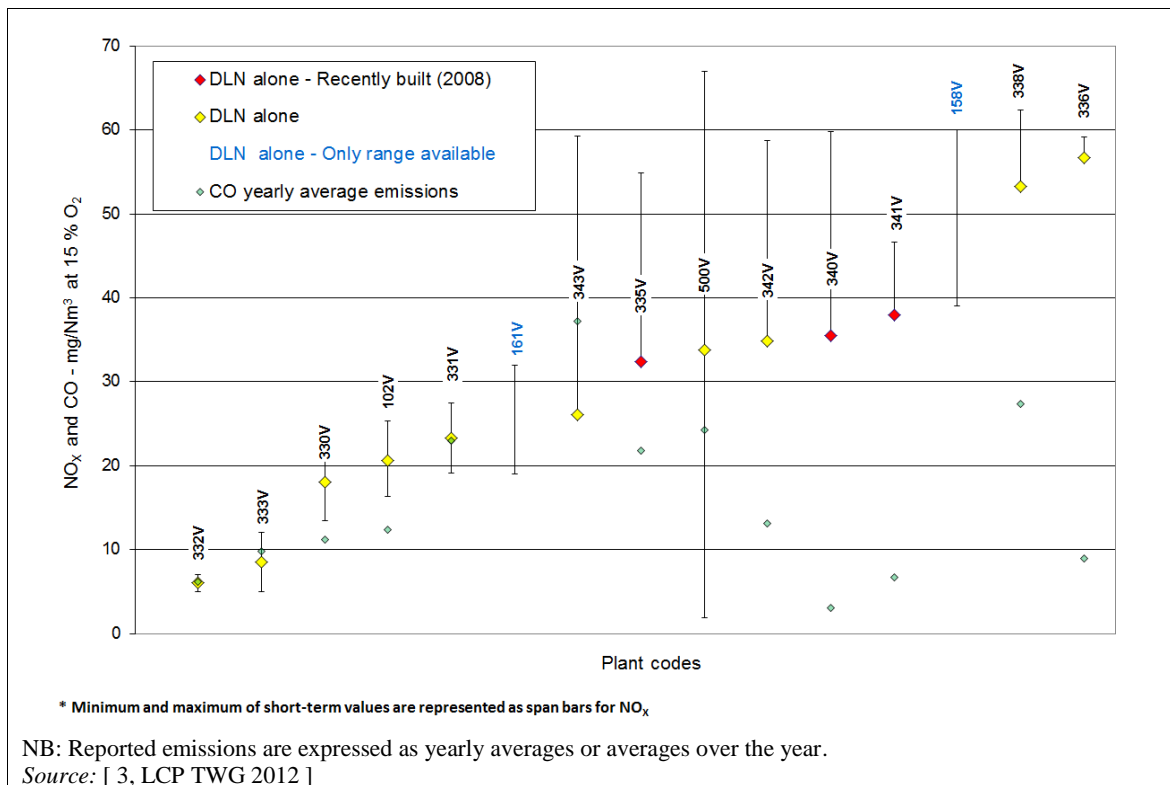

Figure 7.29: NO_x and CO emissions to air in 2010 from well-performing European open-cycle gas turbines operated ≥ 500 h/yr for mechanical drive turbines

When plants are only operated very few hours per year, the level of NO_x emissions is affected by such low plant operation, often with many start-up and shutdown or standby periods that do not enable the techniques in existing plants to work at the design conditions. Figure 7.30 shows the emission levels achieved for open- or combined-cycle gas turbines sized between 35 MW_{th} and 800 MW_{th}, commissioned between 1974 and 2002 and fitted with different techniques: DLN, water injection, standard burners with automatic combustion regulation. The reported plants operate less than 500 h/yr and have emissions slightly higher than similar plants operated in other modes. They have an equivalent full load factor higher than 60 % and CO emissions below 80 mg/Nm³. Almost all of these plants above 50 MW_{th} continuously monitor their emissions, whereas smaller plants (15–50 MW_{th}) perform periodic measurements (from 4 to 30 hourly periodic measurements at plant loads of > 70 %). The corresponding short-term averages (minimum and maximum of half-hourly to 48-hourly average values over a year) range from 22 mg/Nm³ to 185 mg/Nm³.

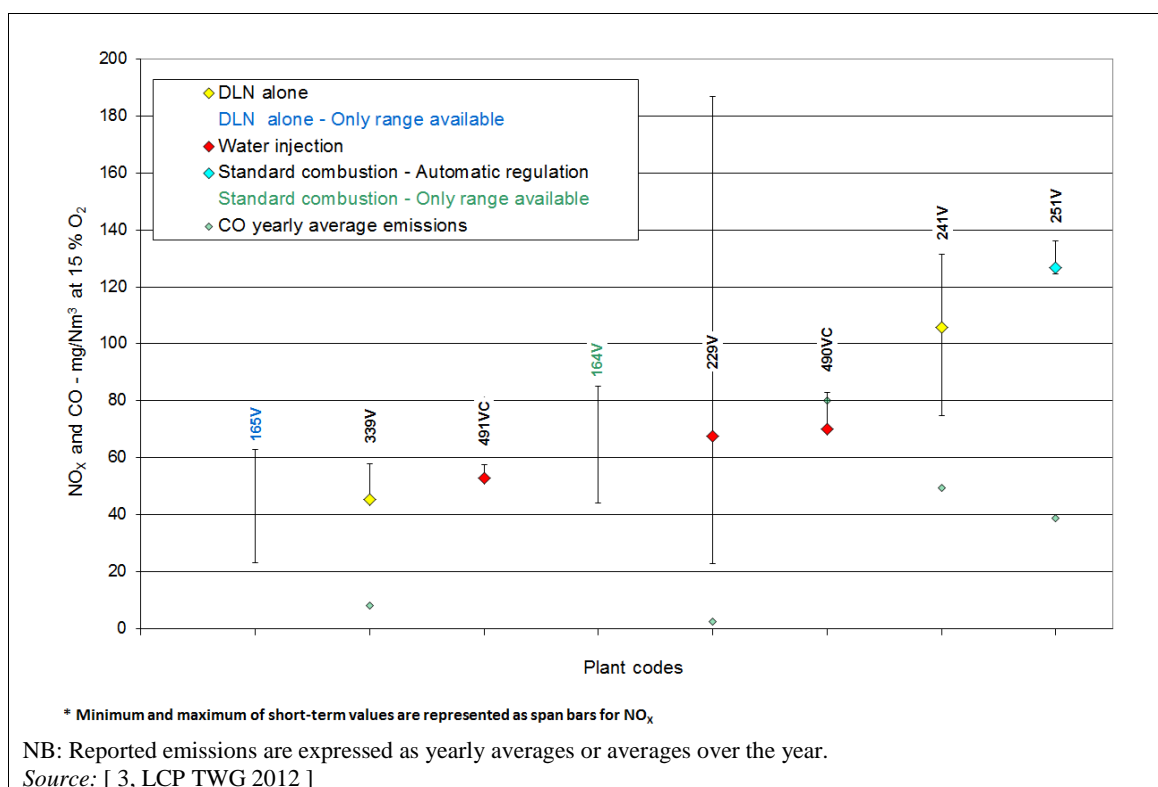

Figure 7.30: NO_x and CO emissions to air in 2010 from well-performing European gas turbines operated < 500 h/yr

7.1.3.2.3 Specific techniques for the prevention and control of NO_x and CO emissions from natural-gas-fired turbines – Catalytic pollution control SCONO_xTM system

Description

Use of a single catalyst that operates by simultaneously oxidising CO to CO₂, NO to NO₂, and then absorbing NO₂ onto its surface through the use of a potassium carbonate absorber coating. This technique does not require ammonia injection.

Technical description

This technique uses a single catalyst that operates over two cycles: oxidation/absorption and regeneration. The catalyst works by simultaneously oxidising CO to CO₂ and NO to NO₂, and then by absorbing NO₂ onto its surface through the use of a potassium carbonate (K₂CO₃) absorber coating. The regeneration of the catalyst is accomplished by passing a controlled mixture of regeneration gases across the surface of the catalyst in the absence of oxygen. The regeneration gases are steam, hydrogen and carbon dioxide. It uses no ammonia and can operate effectively at temperatures ranging from 150 °C to 370 °C. The system emits CO₂, H₂O, N₂ and trace levels of SO₂ to the stack. Due to masking and poisoning of the catalyst, it requires annual catalyst cleaning with deionised water and a K₂CO₃ solution. The spent cleaning fluids can be neutralised and disposed of through the sewerage system and are harmless to the water and soil. An example of a SCONO_xTM system is shown in Figure 7.31.

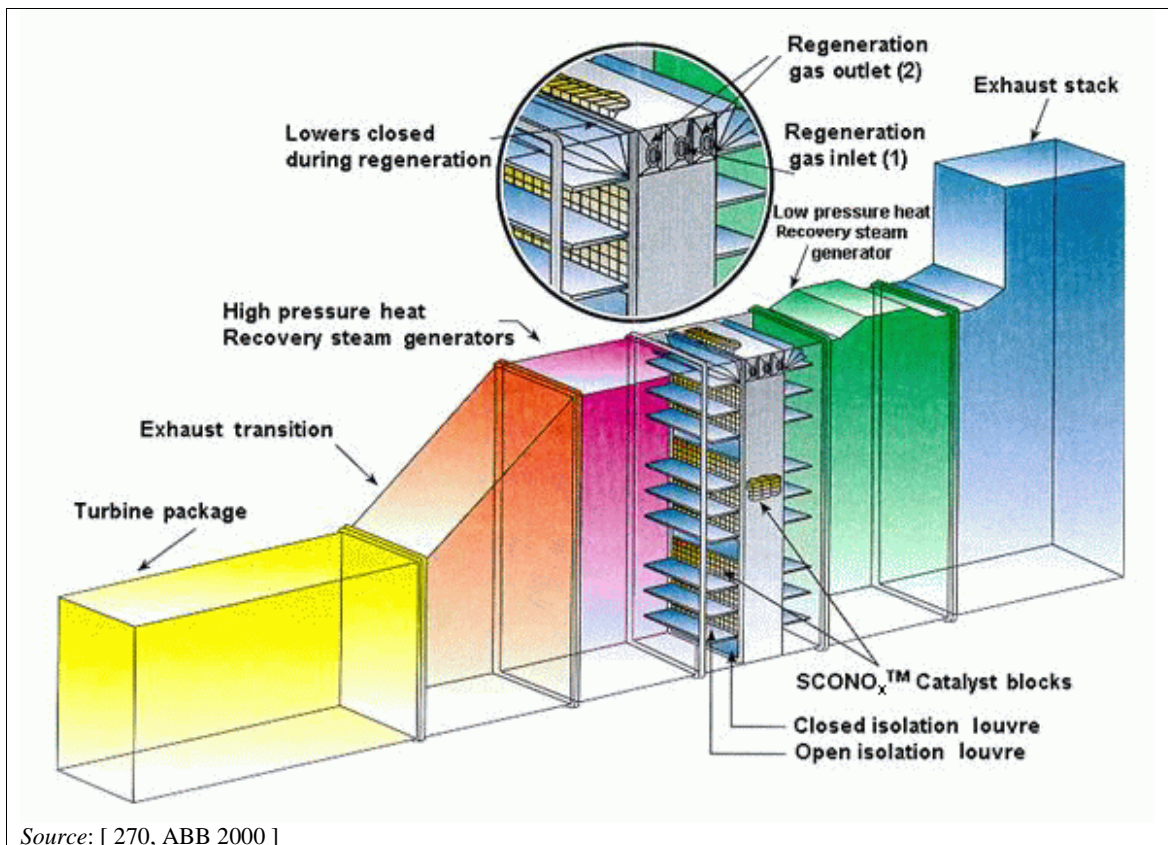

Source: [270, ABB 2000]

Figure 7.31: Schematic representation of the catalytic pollution control SCONO_xTM system

Achieved environmental benefit

NO_x, CO and NMVOC reduction.

In conjunction with a sulphur removal catalyst, this system can also be used for reducing sulphur compounds from the exhaust gas.

Environmental performance and operational data

- NO_x emissions below 2 ppm (4 mg/Nm³ as NO₂ at standard conditions: 0 °C, 1013 mbar).
- Conversion rate of CO into CO₂ is 90 %.
- The destruction of NMVOC is greater than 90 % at 315 °C.
- The reduction rates for formaldehyde and acetaldehyde have been respectively measured at 97 % and 94 % at 150 °C.

Cross-media effects

The SCONO_xTM catalyst is susceptible to fouling by sulphur in the flue-gas. The impact of sulphur can be minimised by a sulphur absorption SCOSO_x catalyst located upstream of the SCONO_x catalyst.

A 0.3 percentage point loss in power output and a loss in power generation due to steam consumption during the washing period can be expected.

Technical considerations relevant to applicability

Applicable to both new and retrofit applications. A SCONO_xTM system can be installed at the back end of the boiler or, in the heat recovery steam generator, within the envelope reserved for an SCR system.

Economics

The estimated cost figures presented below refer to a typical 400 MW_e gas-fired power plant. They are based on 8 000 hours of operation per year and a NO_x reduction from 25 ppm to 5 ppm (50 mg/Nm³ to 10 mg/Nm³ as NO₂ at standard conditions: 0 °C, 1 013 mbar), which equals approximately 666 tonnes annually of NO_x removed. Included in the costings are investment costs, operating and maintenance costs, and indirect annual costs; all costs are estimated in year 2000 prices.

Investment costs: EUR 19.2 million

This includes:

- plant equipment
- delivery
- fitting
- commissioning/start-up.

This is the total cost from the supplier.

Operating and maintenance costs: EUR 1.6 million per year

This includes:

- general maintenance
- steam and natural gas consumption in the regeneration cycle
- energy cost due to pressure drop across the unit
- average cost per year for catalyst replacement (lifetime of the catalyst is seven years)
- catalyst disposal/refund.

Additional indirect annual costs to the contractor are not included.

A reduction of NO_x from 25 ppm to 2 ppm (50 mg/Nm³ to 4 mg/Nm³ as NO₂ at standard conditions: 0 °C, 1013 mbar) would increase the investment costs due to the need for an additional catalyst and would somewhat increase the operating and maintenance costs due to the increased consumption of natural gas and steam, and due to the increased pressure drop.

Driving force for implementation

Requirements to achieve very low NO_x emissions and comply with limitations set on using air pollution control equipment utilising ammonia, especially for plants situated in densely populated areas.

Example plants

- 45 MW_e gas turbine at Redding Electric municipal plant (United States).
- 32 MW_e Sunlaw federal cogeneration plant (United States).
- 5 MW_e Wyeth Biopharma plant (United States).
- 15 MW_e University of California, San Diego, cogeneration plant (United States).

Reference literature

[270, ABB 2000] [49, DeCicco et al. 2004]

7.1.3.2.4 Prevention and control of NO_x and CO emissions from natural-gas-fired turbines at low load

7.1.3.2.4.1 Low-load operation point (LLOP)

Description

Gas turbine operation at very low load whilst keeping NO_x and CO emissions at low levels. This is enabled by a double combustion stage system that can be decoupled when the power demand is low, allowing the running of only one row of burners with the associated gas turbine blading.

Technical description

The electricity market is generally characterised by significant variations in demand during daytime and night-time. For CCGTs, this results in the need to increase the load during the day and decrease it during the night, or even shut down the unit. LLOP is useful in both conditions. If a shutdown is not requested, it allows the unit to operate at a lower load than the conventional minimum load compatible with the performance of the gas turbine during commercial operation, also called Minimum Environmental Load (MEL), while keeping pollutant emissions under control. In case a shutdown is needed only for a few hours, keeping the turbine at LLOP instead of shutting it down can result in lower emissions from the plant and a lower impact on the machine lifetime.

LLOP is achieved using a unique configuration of the gas turbine that incorporates a double combustion stage. A first row of burners is located between the air compressor and the first gas turbine stage. After the first gas turbine stage, a second row of burners is located, followed by the remaining part of the gas turbine blading.

In normal operation, both the burner rows are in service and the natural gas is almost evenly distributed between the two of them. LLOP is achieved by switching off the second burner row and operating the machine with only the first one. In this condition, the efficiency of the plant is slightly reduced, but the unit is capable of supporting a very limited load (about 17 % of the maximum load).

At LLOP, emissions are kept low. Emissions are higher during the transition from MEL to LLOP, but the time needed for this transition is very short, resulting in a limited amount of total emissions. In comparison, shutdowns and start-ups are characterised by high emissions for a longer period of time, which in the case of a short (a few hours) shutdown period usually results in higher total emissions than by maintaining the plant at LLOP throughout the same period.

At LLOP, the flue-gas temperature is lower than in normal operation, resulting in steam of a lower temperature being produced. In order to limit thermal stresses on the steam turbine, it is necessary to gradually control the steam temperature with desuperheaters, during the transition from MEL to LLOP, and vice versa. Generally the emissions during transition from MEL to LLOP mode are authorised as transient emissions.

Achieved environmental benefit

Compared to MEL operation, LLOP enables a reduction both in the emission of pollutants and in natural gas consumption during periods of low or no power demand.

Environmental performance and operational data

If compared to a shutdown and the following start-up cycle, LLOP results in lower emissions of pollutants if the requested shutdown period is limited to only a few hours.

For example, in the case of the Gissi Plant (Plant 195: Italy, 720 MW_{th}), during shutdown and the following start-up cycle, NO_x and CO emissions can reach, respectively, 215 kg and 55 kg, whereas during the LLOP mode, NO_x and CO emissions reach, respectively, 95 kg and 25 kg.

During the LLOP mode, pollutant concentrations for NO_x and CO are below 30 mg/Nm³. For this example plant, if in 2011 the operator had used the LLOP mode instead of shutdown followed by a start-up cycle, 990 kg of CO and 3960 kg of NO_x emissions would have been avoided.

In terms of fuel consumption, during shutdown and the following start-up cycle, 45 000 m³ of natural gas is combusted, whereas 84 000 m³ is combusted during four hours in LLOP mode.

Cross-media effects

Greater consumption of natural gas if compared with start-up/shutdown cycles.

Technical considerations relevant to applicability

Application of this technique may be limited by the availability of an appropriate retrofit package for the installed gas turbine.

Economics

The investment needed to implement LLOP relates to some modifications of the control logic and the installation of bigger steam desuperheaters in the boiler.

In the example of the Gissi plant, the extra capex to implement LLOP capabilities, while construction of the plant was already ongoing, was EUR 3.25 million for the unit (720 MW_{th}). The technique requires negligible additional opex, because no additional components are installed at the plant. The only difference is the size of components compared with the original design (e.g. bigger steam desuperheater), but maintenance requirements remain the same.

Driving force for implementation

- Emission savings during the periods of low electricity prices.
- Lower impact on the lifetime of the machine compared to using shutdown and start-up cycles, which lead to higher stress on the materials.

Example plant

Plant 195.

7.1.3.2.4.2 Airflow control with improved inlet guided vanes (IGV)

Description

Use of specially designed inlet guided vanes (IGV) located in the air combustion path to better control the level of oxygen, depending on the load variations of the gas turbine, thus enabling the same levels of CO and NO_x emissions to be maintained at lower loads.

Technical description

The system allows the increase of the airflow control capability, whilst reducing CO and NO_x emissions in a gas turbine load range, which is extended down to 43–45 %. The main modifications are a new IGV and the first two stages of the compressor vanes and nozzles profile, as well as a new fast-hydraulic IGV actuator.

In Plant 191, the use of three stages of variable guide vanes on the gas turbine compressor allows accurate control of the mass flow through the gas turbine, through the entire operational load range. This allows part-load operation conditions to be optimised, so that a high exhaust temperature is maintained. This in turn gives excellent part-load thermal efficiency.

Achieved environmental benefits

The technique allows the reduction of the operating gas turbine load down to 43–45 %, thereby reducing the fuel consumption during off-peak hours, whilst still keeping NO_x and CO emissions under control. The achievable minimum load is constrained by CO formation, which is influenced by a thorough control of air inflow.

Environmental performance and operational data

Hourly NO_x emissions of < 35 mg/Nm³ in the full range of loads, with CO emissions of < 7 mg/Nm³.

Cross-media effects

None.

Technical considerations relevant to applicability

Applicable to annular combustor-type gas turbines. Air/fuel ratio control is a concern for all gas turbines ('annular' and 'cannular' combustor types). In annular combustor gas turbines, the

problem can be magnified due to the fact that the fuel rate cannot be controlled separately for each combustor, whereas annular GTs allow control of the fuel rate. However, annular combustors are more complex.

Economics

Capex for this technique is about EUR 1.5 million for one gas turbine. The payback time can be short, depending on the frequency and duration of the power market conditions that justify running the unit at minimum technical load.

Driving force for implementation

Better efficiency and flexibility to react to the fluctuations of the power ancillary services market.

Example plants

Plants 191, 276 and 278.

7.1.3.2.4.3 Gas turbine inlet excess air management via a bleed valve discharge

Description

The technique used is a DLN utilising excess inlet air management to optimise the flame temperature control.

Technical description

Inlet excess air management is achieved via a bleed valve discharging, according to the load, part of the gas turbine compressor air.

Achieved environmental benefits

Significant reduction of CO emissions at low load, whilst maintaining low NO_x emissions.

Environmental performance and operational data

For Plant 102 (24 MW_{th}, France), hourly average CO concentrations vary from 1 mg/Nm³ to 195 mg/Nm³ over a year, and the yearly average is 12 mg/Nm³.

The hourly average for NO_x emissions to air varies between 2 mg/Nm³ and 37 mg/Nm³, with a yearly average of 28 mg/Nm³.

Cross-media effects

There is no related waste, and a negligible effect on energy efficiency.

Technical considerations relevant to applicability

The technique is not applicable to all DLN-type technologies or gas turbine designs/sizes. Applicability is higher for smaller gas turbines and lower for aeroderivative gas turbines at lower loads.

Economics

No information provided.

Driving force

No information provided.

Example plants

Plant 102.

Reference literature

No information provided.

7.1.3.2.5 General techniques for the prevention and control of NO_x and unburnt carbon emissions from natural-gas-fired engines

Information on general techniques for the prevention and control of NO_x, unburnt carbon and NH₃ emissions is given in Section 3.2.2.3. Table 7.15 gives information specific to natural-gas-fired engines. More detailed information on environmental performance and operational data, economics, cross-media effects and driving forces is given after the table.

Table 7.15: General techniques for the prevention and control of NO_x and unburnt carbon emissions from natural-gas-fired stationary engines

Technique	Technical description	Achieved environmental benefits	Environmental performance and operational data	Cross-media effects	Technical considerations relevant to applicability		Economics	Example plants	Reference literature
					New plants	Existing plants			
Lean-burn concept	See Section 3.2.2.3.9	Reduction of NO _x	NA	NA	Generally applicable	Not applicable	NA	NA	NA
Advanced control system	See Section 3.2.3.8	Reduction of NO _x , CO, NMVOC, CH ₄ slip	NA	NA	Generally applicable	The applicability to old combustion plants may be constrained by the need to retrofit the combustion and/or control command system(s)	NA	NA	NA
Selective catalytic reduction (SCR)	See Section 3.2.2.3.11	Reduction of NO _x	NA	Ammonia slip – safety issue related to ammonia storage (e.g. in residential areas)	Generally applicable	Applicable within the constraints associated with space availability	Plant-specific – See example Table 7.17 This technique may be costly in the case of plants operated between 500 h/yr and 1 500 h/yr and even more so for plants operated < 500 h/yr	Plants 353, 354	[250, Finkeldei 2000] [251, Krishnan 2002]

	NA	NA	NA	NA	A plant that operates very few hours (e.g. less than two hours per shift) with many start-ups/shutdowns (e.g. one to three per day) may face difficulties to reach the optimum system efficiency if the load varies a lot. This would require a special catalyst design that may not be economically viable for plants operated < 1 500 h/yr		NA	NA	NA
Oxidation catalyst	See Section 3.2.2.7.2 The oxidation catalyst reduction efficiency for NMVOC is very dependent on the hydrocarbon composition in the flue-gas, ethane and propane being especially difficult to remove.	Reduction of NMVOC, and conversion of CO into CO ₂	< 100 mg/Nm ³ for CO emissions		Generally applicable for spark-ignited lean-burn (SG) and dual fuel (DF) engines	Applicable for spark-ignited lean-burn (SG) and dual fuel (DF) engines within the constraints associated with space availability			Plant 186-1
NB: NA: No relevant specific information available.									

Environmental performance and operational data for NO_x and unburnt carbon emissions from gas-fired engines

Well-performing SG- and DF-type engines achieve yearly NO_x emission levels below 100 mg/Nm³. Recent examples, Plants 353V and 354V, commissioned in 2010, operated between 3 500 h/yr and 4 000 h/yr, and fitted with the lean-burn concept and SCR, achieve yearly average NO_x emissions of 27–28 mg/Nm³ with maximum hourly averages over the year up to 105–110 mg/Nm³.

Table 7.16 lists the main performance parameters in the case of two other example gas-fired engine plants fitted with SCR.

Table 7.16: Emission levels of two gas-fired engine power plants equipped with SCR

Location	Plant A	Plant B
	US	US
Commissioning year	2002	2001
Plant type	Power generation	Power generation
Fuel	Natural gas	Natural gas
Combustion technique	20 gas engines	5 gas engines
Capacity	111 MW	14 MW
Secondary technique	SCR (Reagent: aqueous urea)	SCR (Reagent: aqueous urea)
NO _x without SCR (mg/Nm ³)	159	187
NO _x with fresh SCR catalyst * (mg/Nm ³) at 15 vol-% O ₂	5–19	13
NO _x reduction rate over SCR	88–97 %	93 %
Ammonia slip (NH ₃) * (mg/Nm ³) at 15 vol-% O ₂	2–6	< 2
* These NO _x and NH ₃ values are reached under optimal conditions using a new and fresh catalyst and are not expected to be always achieved throughout the lifetime of the catalyst.		

Engines operated < 1 500 h/yr generally achieve an equivalent level of NO_x emissions to engines operated in other load modes. Should it not be possible to use SCR for plants operated < 500 h/yr with many start-ups/shutdowns and with a highly variable load, higher emission levels are expected, as shown by Plant 186-1 which is not fitted with SCR and reports NO_x emission levels of about 175 mg/Nm³ as the maximum of three periodic samples over a year.

The Dutch competent authority performed a study between 2007 (10 engines monitored) and 2009 (30 engines monitored) on small engines (< 5 MW_e corresponding to about 11 MW_{th}), and completed it in 2011 with a further 10 engines. The study reports unburnt hydrocarbon emissions (average of at least three 30-minute measurements under full load) between 330 mg/Nm³ and 500 mg/Nm³ expressed as C at MCR (maximum continuous rating) and at 15 % O₂. The control of unburnt hydrocarbon emissions may be improved by acting on the main engine process parameters affecting the in-cylinder conditions relevant for hydrocarbon emissions which are the air to fuel ratio, the ignition timing and the intake manifold temperature. Another important parameter determining the unburnt hydrocarbon emission base level is the size of the combustion chamber crevices. [253, KEMA 2011].

A study was performed by the Danish competent authority in 2006–2007 in order to get operational feedback on formaldehyde reduction efficiency by using formaldehyde oxidation catalysts (five test engines monitored, sized between 2 MW_e and 5.1 MW_e). Formaldehyde is formed by partial oxidation of natural gas and is a carcinogen. Depending on the type of catalyst used, reduction efficiencies of 95 % decreasing to 85 % after 10 000 hours of operation for one catalyst type and 60 % decreasing to 40 % after the same period of operation for another

catalyst type could be achieved. However, a catalyst degradation rate faster than this was shown in the field tests by a plant operated in the liberalised power market with a large number of starts and stops. Final extrapolation of the test results indicated that formaldehyde emission levels of between 3.8 mg/Nm^3 and 7.5 mg/Nm^3 (15 % O_2) could be estimated for operating cycles between 20 000 hours and 40 000 hours with a catalyst with one or two layers, depending on the initial level of emissions given at engines electrical reference efficiency of 30 %. This translates in emission levels between 6 mg/Nm^3 and 11 mg/Nm^3 (15 % O_2) for an engine electrical efficiency of 44 %. The study concluded that majority of the Danish gas engines would be able to emit less than 20 mg/Nm^3 at 15 % O_2 and 30 % efficiency, corresponding to less than 11 mg/Nm^3 at 15 % O_2 and 44 % electrical efficiency. The reduction of unburnt carbon (mainly ethane and propane) after 10 000 hours of operation could reach 6 % and the reduction of CO emission levels could reach 98 %. The study also concluded on the possibility to use alternative techniques (Incineration and Recuperative UHC catalysts) that, despite a higher cost, would also allow the reduction of unburnt carbon at a high rate (> 98 %). [252, Kristensen 2007].

Cross-media effects

Engine optimisation is a compromise between NO_x emissions, engine efficiency (fuel consumption, and thus CO_2 emission) and other emissions (such as CO and hydrocarbons (HC)). A reduction in NO_x emissions by primary techniques comes at the expense of increased CO_2 emissions (fuel consumption) as well as unburnt emissions, such as CO and HC, and may also finally lead to misfiring, which might eventually damage the engine. When SCR is used to reduce NO_x emissions, the air to fuel ratio can be optimised for the best fuel efficiency, and thus emissions of unburnt substances can also be reduced. Modern gas engines are knock-limited and therefore the potential for operating engines in a richer fuel mode for improved efficiency (and higher NO_x) and lower CO and HC emissions is limited, as other boundary conditions such as engine knock must be respected.

As the lean-burn engine operates in a leaner mode at lower NO_x levels with higher specific fuel consumption, the flue-gas temperature gets colder, and as a consequence the useful heat that can be recovered from the flue-gas (e.g. for steam production in a CHP plant) decreases.

In engines fitted with SCR, urea is mainly used as the reagent, which may result in a certain amount of ammonia being emitted to the air. The catalyst needs to be changed at certain intervals in order to maintain the SCR efficiency and the used catalyst is either regenerated or treated as waste. [23, Finland 2012]

Economics

In Europe but in isolated systems, gas engines are usually operated only during part of the year (i.e. during winter, when there is a need for heating), typically up to 3 500–4 000 h/yr and/or for grid stability needs, and also to support the introduction of renewable energy. Customers are both industry and utilities. In plant applications with varying load conditions, care should be taken to avoid overheating ('cracking') of the SCR catalysts. In ECCA countries, many gas engines are also used in CHP plants.

The costs reported in Table 7.17 have been defined for an engine of about $20 \text{ MW}_{\text{th}}$ or $8.7 \text{ MW}_{\text{e}}$ operated for 4 000 h/yr. For comparability with other sectors, discounting over 10 years is considered to calculate annual costs, with an interest rate of 4 % (however, it has to be kept in mind that although a reciprocating engine in remote areas, e.g. islands, might have a 10-year payback time, small plants on the mainland are often private, with a much shorter payback period, i.e. less than 5 years).

Table 7.17 shows the detailed costs of fitting an example engine power plant with SCR.

Table 7.17: Costs of installing SCR for gas engines operating 4 000 h/yr

NO _x (mg/Nm ³) at 15 % O ₂	35
SCR efficiency required (%)	82
Investment (EUR)	356 700
Cost of reagent (urea) (EUR/t)	300
Total annual cost EUR/yr	84 070
Cost of removed NO _x (EUR/t NO _x abated)	2 395
Additional cost of electricity produced (EUR/MWh _{el})	2.42
Additional cost of electricity produced (%)	3.45
<i>Source: [254, Convention on Long-Range transboundary Air Pollution 2011]</i>	

Driving force for SCR

SCR has been mainly used where local air quality standards required a significant reduction of NO_x emissions or ozone concentrations, e.g. when operating in highly populated areas or in areas with many industries or mobile sources.

7.1.3.3 Techniques to prevent emissions to soil

Table 7.18 summarises the general techniques to be considered in the determination of BAT for the prevention of emissions to soil.

Table 7.18: Techniques for the prevention of emissions to soil

Technique	Technical description	Achieved environmental benefits	Cross-media effects	Technical considerations relevant to applicability	Economics
Soil protection	Install liquid-tight paving (e.g. concrete) with drainage systems (including oil separators to avoid water and soil contamination caused by lubrication oil) in areas where operations that could result in soil contamination are carried out, and before treatment in a settling pond for example	Prevention of soil and groundwater contamination	None	Generally applicable	High operational experience. Cost for waste water treatment

7.2 Combustion of biogas

Biogas is most commonly used for combustion in SG engines. However, in some instances biogas and sewage gas are used for supplementary firing in the HRSG of gas turbines.

Fuel characterisation and preparation/pretreatment

Fuel gas cleaning may be needed when using oxidation (e.g. SCR catalysts), and when burning biogas or landfill gases that might contain catalyst poisons such as NH_3 or H_2S .

[23, Finland 2012]

Energy efficiency of biogas combustion plants

Table 7.19 gives the range of electrical efficiencies achieved in a small biogas-fired gas turbines.

Table 7.19: Overview of efficiencies of a biogas-fired gas turbine

Biogas-fired simple-cycle gas turbine	Maximum unit size (MW_e)	Electrical efficiency (%)
		15

NB: These data have been obtained during full load operation. If the load operation decreases, thermal efficiencies also decrease significantly.
Source: [50, EUTurbines 2012]

Emissions to air

As biogas contains sulphur, its combustion may generate higher SO_x emissions than when combusting natural gas and the use of CO catalysts may be constrained, causing higher CO emissions.

Furthermore, the impurities of the biogas may lead to deposits forming on the SG engine's internal components, which could restrict the achievable NO_x level. NO_x levels far below 190 mg/Nm^3 at 15 % O_2 are difficult to achieve over the operational life of an engine, because of the drift of emissions caused by the resulting isolation effects and the change in combustion chamber geometry. [23, Finland 2012]

Example plants

No plants combusting mainly biogas submitted data in the data collection exercise carried out in 2012 for the review of this BREF.

In France, according to the available information, the largest 100 % biogas-fired gas turbines are in the range of 15–30 MW_{th} . In 2013, no new plants fired with 100 % biogas and larger than 50 MW_{th} were expected in the near future. Nevertheless, there are cases where biogas is fired in conjunction with other fuels like natural gas (Plants 65-1/2 and 421-3) with biogas yearly average participation in the fuel mix between 6 % and 16 % (thermal input basis).

7.3 Combustion of process gases from the iron and steel industry

7.3.1 Applied processes and techniques

In the European Union, the established route for the primary production of steel is via the blast furnace (BF) and the basic oxygen furnace (BOF). Iron oxides are reduced in the blast furnace process utilising the gases carbon monoxide (CO) and, to a lesser extent, hydrogen (H₂) derived from coke and other reductants, such as injected coal, oil, moisture, etc. CO is generated in the blast furnace by oxidation of the coke by oxygen in the oxygen-enriched blast air. In order to drive the reduction of the iron oxides at a commercial rate, the gases leaving the blast furnace must contain some residual reducing gases, CO and H₂, together with significant levels of N₂ and CO₂. The resulting blast furnace gas (BF gas or BFG) will thus have a small heating potential when fully oxidised. The hot metal produced by the blast furnace contains impurities, notably carbon, silicon and manganese, which have to be removed. This is achieved by oxidation in the BOF; the silicon and manganese are removed in the slag, while the carbon is removed in gaseous form. During the oxidation of the carbon in the iron in the BOF, the off-gas will contain sufficient quantities of CO to allow it to be used as a fuel (BOF gas). The coke used in the blast furnace is often produced on site, using recovery coke ovens, in which the coals are effectively distilled in an oxygen-free environment to produce coke and coke oven gas (COG). The coke oven gas contains significant amounts of methane and hydrogen so that, once cleaned, it can be utilised as a high calorific value fuel gas.

Throughout the production route, from raw materials to finished steel, coal is fundamental in providing the reductant and gaseous energy source for the majority of the processes in an integrated steelworks. The process gases are produced as a consequence of the operations to produce metallurgical coke (COG), to produce hot metal (iron) in the blast furnace (BFG), and to convert this hot metal to steel in the basic oxygen furnace (BOF gas).

The three process gases, coke oven gas (COG), blast furnace gas (BF gas) and basic oxygen furnace gas (BOF gas), have significantly different compositions and consequently calorific values. Over the short term (minutes to hours) and over the longer term (weeks to years), the process gases can vary significantly in volume, availability and composition. The gases are produced at plants in different locations within a particular steelworks and, consequently, their distribution to users can be complicated. Within an integrated steelworks, these gases are a valuable energy source, but the planned or sudden loss of either a process-gas-consuming plant e.g. a hot mill going down, or a process-gas-producing plant, e.g. the loss of a blast furnace in a one- or two-furnace plant, has to be managed effectively to minimise flaring. In the steelworks, boilers and gas turbines are the lowest-priority users, ahead of flaring excess gas, and thus are the first to suffer depletion of supply when a particular gas is required to satisfy a process demand elsewhere in the works. Consequently, the boilers and gas turbines are designed, as far as possible, to be able to respond to these conditions and moderate the impact of these fluctuations on the rest of the iron- and steelworks and, by minimising the flaring of gases, on the environment.

The processes used in steel production are significant consumers of energy, so energy use is strictly managed. This means that the energy flows in an integrated steelworks can be complex, as illustrated in Figure 7.32. The top priority of energy management in the steelworks is to optimise overall energy efficiency by maximising the use of process gases within the steelworks itself. Different processes require gases with different calorific values for acceptable levels of fuel efficiency, e.g. the higher the required process temperature, the greater the amount of high calorific gases needed. Process gases are often blended to provide these varying requirements, and systems to buffer fluctuations in process gas availability in the short term (less than an hour) are used to regulate the quality and quantity of the fuel gases to some extent. Excess volumes of process gases are utilised in Combined heat and power plants with the primary purpose of producing steam for direct or indirect use in the steel industry production processes and with the

secondary purpose of generating electricity, if sufficient process gases are available. The generation of steam is an important operation in the steelworks, as steam is required for many purposes. In an integrated steelworks, steam can often be raised through heat recovery systems, e.g. in the BOF hood cooling systems or in the reheating furnaces of a hot rolling mill. In order to achieve a stable steam supply, it is necessary to have a backup system for steam production, to supply the steam demand when the relevant units of the steelworks are offline for maintenance, for example.

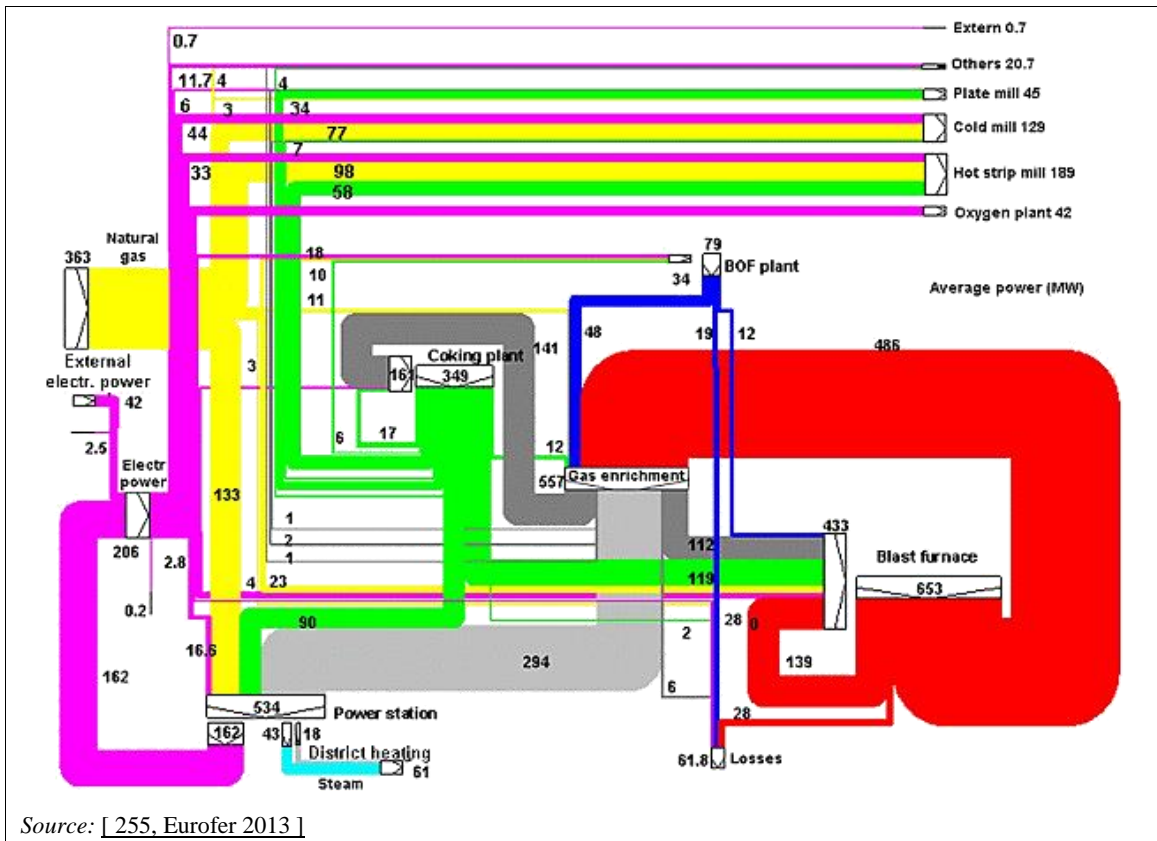

Figure 7.32: Example of energy flows in an integrated steelworks

Combined Heat and power plants are used to fulfil this role and additionally to control the pressure in the steam grid. The most important consumers of steam in the works are blast furnace operations, the coking plant (steam turbine for gas exhausting, for example), and vacuum treatment in the steel plant. In a steelworks, the power plant is often tasked with the production of the blast furnace blast, utilising steam and turbo-blowers. This is a top priority for the power plant when the blowers are run by steam. (Electro-blowers avoid the use of steam and are considered preferable to turbo-blowers.) The steam produced can also be used for compressed air production, cleaning processes at the galvanising and annealing plants, pretreatment in the pickling plants, and for space heating when necessary.

Management systems are employed to optimise the beneficial use of all of the process gases. The objectives are prioritised as:

1. internal use of the heating potential of the gases in steel production processes;
2. minimisation of use of natural gas and other fuels as auxiliary fuel(s) in the enrichment of process gases, and as fuels combusted alone;
3. sensible use of the gases in the production of steam and/or electricity, so energy is not wasted by flaring;
4. minimisation of fuel gas use through process-integrated techniques;
5. avoidance of imported electricity.

The processes employed in the preparation of the iron and steel process gases prior to their use are described in the IS BREF (2012).

A good plant layout can facilitate the efficient distribution and use of the process gases and purchased fuels in an integrated steelworks. COG, BF gas and BOF gas constitute the basis of the energy system in an integrated steelworks. Most of the energy demand is satisfied by these gases while the remaining demand is balanced with purchased energy, normally electrical power, together with an auxiliary fuel (that may include natural gas, oil, coal, etc.) depending on local availability and conditions. These aspects are illustrated in Figure 7.32. The plate mill, for example, draws much of its energy requirement from the coke oven gas, some from the natural gas 'make-up' and a small amount of electrical power that may be internally or, at times, externally generated. Other steelworks lacking access to natural gas may use alternative auxiliary fuels such as oil and coal.

7.3.1.1 Fuel characterisation and preparation/pretreatment

The three main process gases in the steel industry, COG, BFG and BOF gas, have quite different characteristics, are produced from different processes, and can be consumed throughout the works for many purposes, depending on the gas properties and availability in terms of production and location within a site.

A comparison of the three process gases and an average natural gas is given in Figure 7.33, where the inert gas portion includes nitrogen and carbon dioxide.

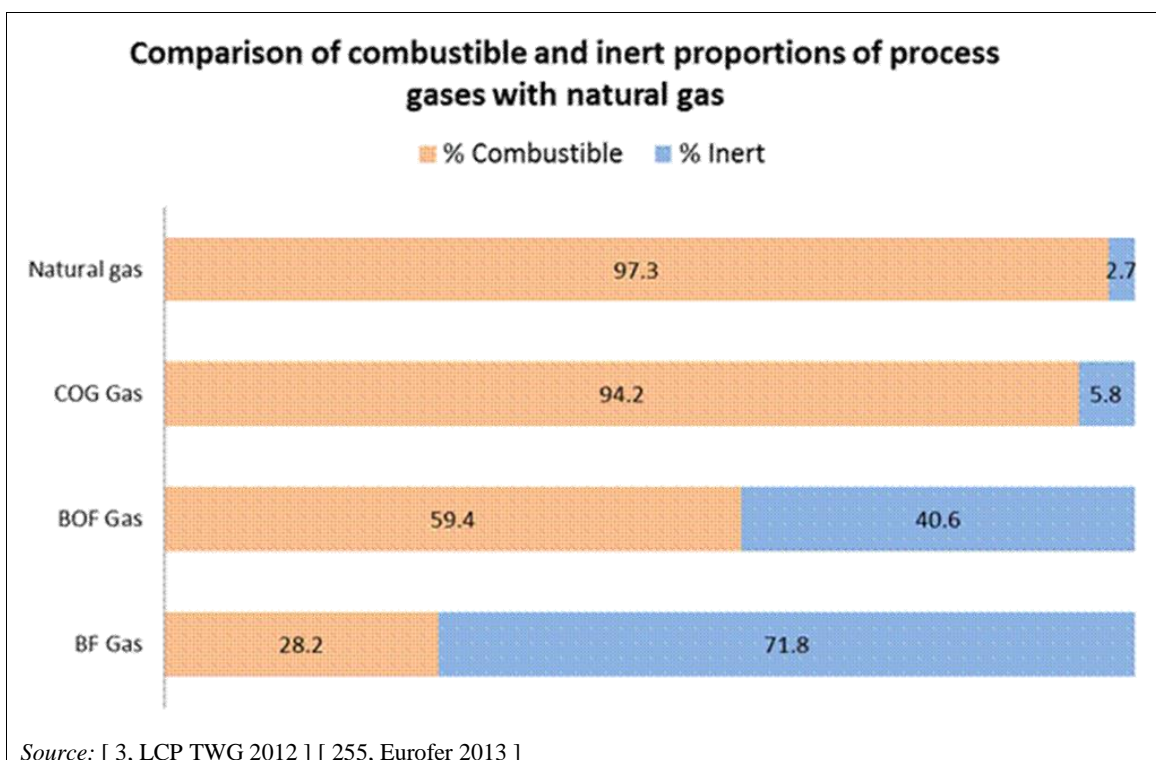

Figure 7.33: Comparison of iron and steel process gases and natural gas

Coke oven gas (COG)

Coke oven gas is derived from the dry distillation (coking) of specific types of coal to produce metallurgical-grade coke, an essential burden component and the major reductant in the blast furnace for the production of iron. Only certain coals can be converted to coke and several types may be blended to achieve the desired coke properties. These coke properties are required for

blast furnace operational reasons and consequently the resultant COG composition can be affected. Other materials that contain carbon may also be used in small quantities. Oil or oil residues are added to give a better compaction of the coal.

Raw COG has a relatively high calorific content, due to the presence of hydrogen, methane, carbon monoxide and hydrocarbons. The raw coke oven gas also contains valuable products such as tar, light oil, sulphur and ammonia. COG is treated as described in the IS BREF (2012) before use as a fuel. Cleaning includes the removal of tar, naphthalene, light oil, compounds that contain sulphur, and the removal or cracking (to hydrogen) of ammonia.

Based upon the data collected for the revision of the LCP BREF (2012) and on additional data collected by EUROFER, the cleaned COG used in combustion plants has the compositional ranges given in Table 7.20

Table 7.20: Cleaned COG characteristics

Parameter	Unit	Max.	Min.	No ⁽¹⁾
Lower heating value	MJ/Nm ³	19.65	16.2	16
Wobbe index (lower)	MJ/Nm ³	34.21	11.2	6
Chemical analysis				
H ₂ O	vol-%	3.0	1	3
CH ₄	vol-%	28.29	17	16
C ₂ H ₆	vol-%	3.4	0.39	12
C ₂ H ₄	vol-%	3.0	0.6	10
C ₃	vol-%	1.6	0.05	6
C ₄	vol-%	3.0	0 ⁽³⁾	9
H ₂	vol-%	70	50	16
CO	vol-%	10	4	16
Total S	mg /Nm ³	350 to 780 ⁽²⁾		
NH ₃	mg/Nm ³	0 ^(2,3) – 48 ^(2,4)		
CO ₂	vol-%	2.69	0.8	15
N ₂	vol-%	7	1	16
Dust	mg/Nm ³	< 10		
Siloxane content in the dust		None		
⁽¹⁾ Number of data points in the analysis. ⁽²⁾ Additional data collected by EUROFER. ⁽³⁾ Zero levels indicate below the level of detection using normal analysis techniques. ⁽⁴⁾ Spot sample. Source: [3, LCP TWG 2012]				

As COG is a gas with a relatively high calorific value, it is suited for use in high-temperature applications in the steelworks and as a supplement to lower calorific value gases for internal plant use. However, the cleaned gas can still contain up to 9 % inert gases, N₂ and CO₂.

The H₂S content of the COG is reduced by means of desulphurisation by an absorption system or by wet oxidative desulphurisation. However, total sulphur levels in COG are higher due to the presence of organic sulphur compounds, which can add a further 200–300 mg S/Nm³. [279, COM 2013]

The uses of COG in an integrated steelworks are many and varied. Although the details may differ from works to works, the use of COG in boilers and gas turbines is dependent upon its availability after the other processes have been satisfied, resulting in a priority for steam and

power generation just above flaring. The position of steam and power generation in the plant hierarchy has consequences for the loading of the boilers and gas turbines, and hence for the operating efficiency.

Blast furnace gas (BF gas)

A blast furnace produces approximately 1 200–2 000 Nm³ of BF gas per tonne of hot metal. The energy content of BF gas is typically 2.7–4.0 MJ/Nm³, depending on its carbon monoxide concentration and hydrogen content, which is only about 10 % of the energy content of natural gas. Nevertheless, due to the large amounts of BF gas generated, the total energy potential in terms of GJ is by far the largest of all three of the process gases produced in an integrated steelworks.

BF gas is comprised of combustible species (CO: 20–28 %, H₂: 1–5 %), inert compounds (N₂: 50–55 %, CO₂: 17–25 %), together with dust, sulphur compounds, ammonia and hydrocarbons. To be used as a fuel, the BF gas is treated to meet quality specifications, and is then often used for various firing processes, such as for stove blast generation or for coke oven firing.

BF gas treatment consists of a pretreatment for the removal of coarse dust, and subsequent wet scrubbing for the removal of fine dust and sulphur compounds. In some plants, electrostatic precipitation is applied. After cleaning, the BF gas contains less than 10 mg/Nm³ dry dust.

An analysis of cleaned blast furnace gas used in combustion plants is presented in Table 7.21

Table 7.21: Cleaned BF gas characteristics (average annual data)

Parameter	Unit	Max.	Min.	No ⁽¹⁾
Lower heating value	MJ/Nm ³	4.52	2.7	18
Wobbe index (lower)	MJ/Nm ³	3.67	2.69	4
Chemical analysis	(dry basis)			
CH ₄	vol-%	8.08	1.00	5
C ₂ H ₆	vol-%	0.61	0.01	4
C ₂ H ₄	vol-%	0.03	0.03	1
H ₂	vol-%	14	1	18
CO	vol-%	29.70	19.38	18
Total S*	mg/Nm ³	19 ^(2,3) – 110 ^(2,4)		
CO ₂	vol-%	26	12.70	18
N ₂	vol-%	58	38.70	18
Dust	mg/Nm ³	< 10		
⁽¹⁾ Number of data points in the analysis. ⁽²⁾ Additional data collected by EUROFER. ⁽³⁾ Spot sample. ⁽⁴⁾ Annual average based upon daily average. Source: [3, LCP TWG 2012]				

BF gas is the process gas in the iron and steel industry with the lowest calorific value and flame temperature. The data in Table 7.21 show that BFG is a lean gas (with a LHV average of only 3.4 MJ/Nm³), with about 72 % of the gas as inert and 28 % combustible. In general, it is necessary to supplement BF gas with fuels of a higher calorific value to aid stable combustion. The need for a supplementary fuel depends on the hydrogen content in the BF gas. BF gas is mostly used in low-temperature processes, with the remaining BF gas used in boilers and gas turbines to produce process steam and electrical power; it is nearly always utilised in association with another fuel, with most plants using COG and/or BOF gas. Of the 61 European plants that reported data for the LCP BREF review, only 2 operated without any BF gas in the reporting year.

Basic oxygen furnace gas (BOF gas)

The hot metal (iron) produced in the blast furnace is saturated with carbon and contains other elements such as silicon, manganese, sulphur and phosphorus. The sulphur content in the hot metal is often removed prior to the BOF process step in a hot metal pretreatment station. In essence, the undesirable elements are removed in the basic oxygen furnace by oxidation using a blast of high purity oxygen, the carbon being mostly removed in gaseous form (CO), while the silicon, manganese and phosphorus are oxidised and are removed as slag. The BOF process is a batch process and oxygen blowing lasts for about 15 minutes in a total cycle of 30 to 40 minutes, depending on operating conditions. The generation of carbon monoxide is limited to this blowing period. However, where possible, BOF gas is recovered, cleaned and short-term buffered for subsequent use as a fuel. In some cases, it is not economically feasible to recover the BOF gas for use as a fuel elsewhere in the steelworks, and the BOF gas is then combusted in situ with the generation of steam, hot water or heat.

Recovering the energy potential from the BOF gas involves making efficient use of both the sensible heat and the chemical energy in the BOF gas. In the past, most of the chemical energy was dissipated by flaring. BOF gas produced during oxygen blowing leaves the BOF through the converter mouth and is subsequently caught by the primary exhaust system. This gas has a temperature of approximately 1 200 °C and a flow rate of approximately 50–100 Nm³/t steel. The gas contains approximately 70–80 % carbon monoxide (CO) when leaving the BOF and has a heating value of 6–10 MJ/Nm³. Generally, two systems can be used to recover energy from the converter gas, either partial/full combustion or suppressed combustion.

The cleaning of the recovered BOF gas is achieved by using the following techniques in combination:

- use of a suppressed combustion process;
- pre-dedusting to remove coarse dust by means of dry separation techniques (e.g. deflector, cyclone) or wet separators;
- dust abatement by means of:
 - dry dedusting (e.g. electrostatic precipitator) for new and existing plants,
 - wet dedusting (e.g. wet electrostatic precipitator or scrubber) for existing plants.

The composition of the BOF gas varies with the process used, the recovery method and, specifically, the oxygen volume. After treatment, the BOF gas available for use in the combustion plants has the characteristics given in Table 7.22.

Table 7.22: Cleaned BOF gas characteristics (average annual data)

Parameter	Unit	Max.	Min.
Lower heating value	MJ/Nm ³	8.40	6.34
Wobbe index (lower)	MJ/Nm ³	8.5	7.98
Chemical analysis			
H ₂	vol-%	4.00	0.47
CO	vol-%	69.05	52.52
CO ₂	vol-%	20.20	15.14
N ₂	vol-%	26.90	13.92
Dust	mg/Nm ³	< 10	
NB: S compounds in BOF gas are below the level of detection using normal analysis techniques. Source: [3, LCP TWG 2012]			

BOF gas is classified as a lean gas in terms of calorific value, with an average LHV of 7.03 MJ/Nm³ and average Wobbe index of 8.40 MJ/Nm³, but it belongs to the group of rich gases in terms of its combustion properties (and particularly, its combustion temperature). In addition, it is regarded as a relatively clean gas, with a dust content of < 10 mg/Nm³. However, it can contain 29–47 vol-% N₂ and CO₂ inert gases and according to the I&S BREF [279, COM 2013], the residual dust concentration after buffering the BOF gas can be up to 50 mg/Nm³.

The use of BOF gas in conjunction with BF gas and COG brings substantial advantages if it allows for the replacement of considerable amounts of primary energy resources, such as natural gas or other auxiliary fuels. Of the plants considered in the 2012 data collection of the LCP BREF review, 10 use BOF gas as an enrichment gas in order to improve the caloric value of BF gas in a steelworks. A comparison of the LHV and the Wobbe indices of the three main types of process gases for the plants covered in the data collection exercise is given in Table 7.23

Table 7.23: Comparison of the average LHV and Wobbe index values for BF gas, BOF gas and mixed BF + BOF gas

	Unit	BF gas	BOF gas	BF + BOF gas
Lower heating value	MJ/Nm ³	3.41	7.10	3.94
Wobbe index (lower)	MJ/Nm ³	3.25	8.4	4.05
<i>Source: [3, LCP TWG 2012]</i>				

However, even the use of BOF gas alone is insufficient for use in steam or power generation, and hence in all 10 plants natural gas (NG) and COG are used to further improve the gas properties.

Auxiliary fuels

The use of auxiliary fuels is a normal practice for plants using iron and steel process gases. These may be required specifically for start-ups from cold, where the available process gases have insufficient calorific value to bring the boiler to operational temperature in a reasonable timeframe. Auxiliary fuels are also used during times of disruption of the normal supply of the process gases, to maintain critical boiler functions (especially process steam). Occasionally, auxiliary fuels may also be used in the normal operation of the boiler plant.

The fuels used in plant start-up, consumed in very small amounts, are typically propane (LPG), natural gas, gas oil or heavy fuel oil. The selection of these fuels largely depends on availability, e.g. oil is used where natural gas is not available.

The fuels used as auxiliary fuels are natural gas, light crude oils, heavy fuel oil, tar, and coal. Of these, the most widely used is natural gas.

Natural gas

Natural gas is used in about 65 % of the combustion plants in this section. For some plants its use is not possible due to the lack of infrastructure. Natural gas is used as a start-up, backup and auxiliary fuel at annual levels as low as 0.1 % to 88.4 % on a thermal input basis. The quality of the natural gas used in combustion plants in steelworks varies widely as can be seen in Table 7.24 below.

Table 7.24: Composition of natural gas used in combustion plants firing iron and steel process fuels

Parameter	Unit	Max.	Min.	No ⁽¹⁾
Lower heating value	MJ/Nm ³	37.9	31.8	30
Wobbe index (lower)	MJ/Nm ³	54.5	11.3	20
Chemical analysis				
CH ₄	vol-%	99	80	34
C ₂ H ₆	vol-%	7.42	0.90	32
C ₂ H ₄	vol-%	2.20	0.00	2
C ₃	vol-%	1.90	0.06	31
C ₄	vol-%	2.34	0.02	26
CO ₂	vol-%	2.76	0.19	32
N ₂	vol-%	11.81	0.60	33
⁽¹⁾ Number of data points in the analysis. Source: [3, LCP TWG 2012]				

Even with relatively high levels of CO₂ and N₂, the average level of inert gas is low in comparison with BF gas and BOF gas and is of a similar level as in COG, as illustrated in Figure 7.33.

Other fuels

Other fuels including gas oil, coal tar and coal are used in very few specific plants, mostly to maintain the operating temperature or as supplements to the main process gases. Coal is also used as an additional fuel in one plant considered in this section, at 4.7 % with 95.3 % COG on a thermal input basis. On the other hand, iron and steel process gases can be used to replace coal in coal-fired plants, as is the case in several plants in Europe where the coal participation is between 37 % and 93 % (see Section 5.1 on coal combustion and Chapter 0 on liquid fuel combustion).

Heavy oil usage varies from 0.4 % to 12.1 %. At the lower end, it is used as a start-up fuel (0.4–1.2 %) while at the higher end, it is used as a complementary fuel to the process gases where natural gas is not readily available. Coal tar is used under similar circumstances.

In all cases, the use of these other fuels can have an impact on the emissions from the boilers and gas turbines.

7.3.1.2 Control of emissions to air from boilers

The role of boilers in an integrated steelworks is to consume the excess process gases and provide the necessary steam and hot water to all the key processes. Some steelworks may also generate some electricity to valorise the process gases. As described previously, since the process fuels (BF gas, COG and BOF gas) are also used in other areas of the integrated works, most integrated steelworks need to purchase additional fuels (e.g. oil, coal, natural gas). The demand for these additional fuels can vary over short periods of time, depending on the operational availability of the consuming plants in the steelworks. Steam and power plants can utilise both low calorific and high calorific gases and, depending on the energy situation of a plant, the power plant can be set up to produce electrical power, steam for use in various situations and/or district heating. A CHP plant can often be used to fulfil the demand for steam when the dedicated boilers are offline for maintenance, and can additionally be used to control the pressure in the steam grid.

The overall energy efficiency of an integrated steelworks power plant is generally lower than in commercial power plants, and the emission levels, e.g. for SO_x and dust, are different. The operation of power plants in integrated steelworks that are fired with BF/BOF gas and/or COG is dependent on the production of the whole integrated iron- and steelworks. When comparing these with commercial large combustion plants, it is necessary to consider variations in the amounts and compositions of the fuels, their combustible and inert contents, the timely availability of these fuels from the iron and steel production processes, and qualitative and quantitative variability of parameters such as the calorific value.

The main air pollutants emitted by boilers fired with process gases generated by steelworks are NO_x, CO, SO_x and dust.

NO_x

Because of the comparably low flame temperature when burning BF gas, the formation of thermal NO_x is lower than for other process gases and natural gas. The amount of fuel NO_x generated depends on the nitrogenous compounds. As the amounts of these nitrogenous compounds, mostly residual ammonia, remaining in COG may be substantial (although data collected by EUROFER indicates this to be < 50 mg/Nm³ in random sampling), the amount of fuel NO_x generated from this source may also be significant (see Table 2.6 of the IS BREF (2012)). The formation of thermal NO_x resulting from combustion and multi-firing of COG with natural gas may also be high due to the high combustion temperatures. Most commonly, primary techniques are applied to reduce the formation of thermal NO_x and, under some local conditions, secondary techniques are applied to reduce emissions of both thermal and fuel NO_x.

Carbon monoxide

CO constitutes over 50 % of BOF gas and is also the major combustible component of BF gas, while in COG it is a minor component. In power plants using these process gases, the objective is to combust to completion, resulting in low emission levels in the flue-gas. However, boilers operated in the steelworks are subject to sudden changes of the input fuels, which may negatively affect the efficient combustion of the gases.

SO_x

The principal source of SO_x in the emissions of the plants using process gases is derived from the oxidation of residual sulphur compounds contained in COG and in BFG, mainly in the form of H₂S and organic sulphuric compounds. No further techniques are applied in the plants combusting mainly these gases.

Reported yearly average levels in the data collection show H₂S levels in the COG between 15 mg/Nm³ and 300 mg/Nm³ for the year 2010 [3, LCP TWG 2012]. The total sulphur load in COG is normally in the range 350 mg/Nm³ to 780 mg/Nm³, but could be higher due to the presence of organic sulphur compounds. In some plants, higher levels of total S have been reported in the COG. The levels for total sulphur in BFG are considerably lower at 40 mg/Nm³ to 110 mg/Nm³. [255, Eurofer 2013]

Dust

BF gas and BOF gas are dedusted before they are used in boilers, while COG is treated in a by-product plant, resulting in a reduced dust content compared with the raw gas. Precursors for dust such as sulphur are also reduced. This results in a comparatively low residual dust content in the flue-gas after combustion. Thus the control of dust emissions to air when using process gases from the steel industry is mainly achieved by the removal of particulates before combustion, as described in the IS BREF. [279, COM 2013]

7.3.1.3 Control of emissions to air from gas turbines

Gas turbines fired with process gases are not commonly used in Europe because of the low calorific value of the gases, the limited capacity to accept variations of the calorific value of the gases over time and a poor turndown ratio. Natural gas is the fuel of choice for gas turbines.

In order to improve energy efficiency, the gas turbines are often coupled with a heat recovery boiler, where process gases can be used to provide the additional heat (see Section 3.2.3.2 of this document and p. 29–30 of the IS BREF (2012)). Since most integrated steelworks sites have a surplus of heat, there is little or no internal demand. If there are no private or commercial consumers available to use the decoupled heat, power plants are operated to combust the surplus gases to maximise the amount of electrical energy.

Of the eight European gas turbine plants or CCGTs that use I&S process gases and that submitted data for the LCP BREF review, three of them use exclusively NG in the gas turbine operation. One stand-alone gas turbine operates on a mixture of 59.4 % NG, 29.1 % BF gas and 11.5 % COG, but can also operate on 100 % NG with steam injection as required. Three CCGTs operate on a mixture of NG, BF gas, COG and BOF gas, and the supplementary boiler fuels are NG and BF gas (these plants can also be run on 100 % NG with steam injection). The eighth plant has a stand-alone gas turbine that operates on a high level of particularly clean BFG (96.5 % on a thermal input basis). The composition of the BF gas in this case is exceptional, as the high H₂ and CO contents confer a higher LHV of 4.4 MJ/Nm³, compared with an average value of 3.4 MJ/Nm³. The remaining 3.5 % is made up of 2.2 % BOF gas that has been admixed to the BF gas and 1.3 % NG.

These plants control their dust and SO_x emissions through the same fuel pretreatment techniques as those used when process gases are combusted in boilers, and control their NO_x emissions by implementing dry low-NO_x burners, steam injection when the gas turbine combusts natural gas, low-NO_x burners for the boiler part, or SCR. One gas turbine is also fitted with fuel preheating. In one operation where the process gases are used in the gas turbine of the CCGT, the COG is treated to remove traces of oils and tar.

7.3.1.4 Water and waste water treatment

The use of water and the treatment of all waste waters from the cleaning of iron- and steelworks process gases are fully addressed in the IS BREF (2012).

Many of the boilers utilising the cleaned process gases from the iron and steel industry are located close to or within the boundaries of the steelworks producing the process gases. In these situations, the management of water usage and disposal of waste water is normally handled centrally, with a common system of drainage and discharge to local watercourses for the whole steelworks. Water flows from LCPs are not significant compared with the total flows at the site release points, and often are not closely monitored individually. It is therefore not generally possible to isolate the emissions to water from individual LCPs. Under these circumstances, the site abstraction, use, and discharge consents are applicable and appropriate monitoring is applied.

There are some occasions where small amounts of relatively clean water, such as condensate, blowdown from small boilers or pump effluents do not require any waste water treatment and can be discharged directly to a watercourse. These discharges are often not subject to regulation or monitoring. There are some facilities, however, where relatively clean water that is discharged directly to rivers is monitored for flow, temperature and ammoniacal nitrogen (NH₃-N), and thresholds and limits are applied through a permit system. Other plants discharging directly to a river have permit conditions relating to volume, temperature, pH, ammoniacal nitrogen (NH₃-N), total suspended solids (TSS), phosphorus and total organic carbon (TOC). Some coastal water sites are required to carry out spot checks for specific metals contents.

At a few sites, the production of deionised water results in a waste water flow that is dealt with separately or initially in a waste water treatment plant. This might consist of neutralisation and sedimentation as treatment techniques, after which the water can be discharged to the environment. In this situation, separate discharge conditions are applied in relation to flow, temperature, pH, TSS and adsorbable organic halides (AOX).

7.3.2 Current emission and consumption levels

7.3.2.1 Iron and steel process gases used in large combustion plants

In order to better understand the values for plant efficiencies and emissions to air for plants utilising steelworks process gases, it is essential to appreciate the scale of the use of these gases in terms of volume as opposed to thermal input alone. In Table 7.25 it can be seen that the process gases are less effective fuels than natural gas, to the extent that in general terms of thermal input, 1 volume of natural gas is matched by about 2.6 volumes of COG, 6.5 volumes of BOF gas and 13.5 volumes of BF gas [3, LCP TWG 2012]. These factors are summarised in Table 7.25 below for more than 50 European plants.

Table 7.25: Gas volumes, additional fuel tonnages and thermal inputs per 24 hours for combustion plants firing iron and steel process gases

Gas/Additional fuel	Total amounts		Thermal input/24h (MW _{th})
BF gas	139 763 766	Nm ³ /24h	136 880
BOF gas	2 379 432	Nm ³ /24h	5 125
COG	9 492 597	Nm ³ /24h	45 391
COG + BF gas	3 108 945	Nm ³ /24h	2 384
BF gas + BOF gas	23 607 329	Nm ³ /24h	24 464
NG	4 505 974	Nm ³ /24h	45 983
Light crude	890	t/24h	1 027
HFO	146	t/24h	1 778
Coking tar	39	t/24h	402
Coal	30	t/24h	275
<i>Source: [3, LCP TWG 2012]</i>			

Data in Table 7.25 show the importance of BF gas, both in terms of thermal input and of volumes used. The volumes of COG that are used are considerably lower, but the higher calorific value supplements the BF gas, so both gases are often used mixed together in different proportions, like for example the COG and BF gas mixture shown in Table 7.25. In volume terms the amount of BOF gas used reflects the peculiarities of the BOF process, cleaning and storage/buffering of a batch-produced process gas in sufficient beneficial quantities.

The use of tar in 2010 as an auxiliary fuel reflects its availability at the user site, but the practice has now been discontinued. Commercial auxiliary fuels such as natural gas, coal, gas oil add further costs to the production of steam and power and are used cautiously by steel producers, to maintain the outputs and/or for flame stabilisation but generally not to maintain the plant at full load.

7.3.2.2 Energy efficiency of iron and steel process-gas-fired combustion plants

The energy efficiency of an integrated steelworks combustion plant firing process gases is lower than the energy efficiency of a commercial power plant. The operation of such plants is dependent on the production of the whole works and is carried out in such a way so as to avoid the flaring of these gases which would result in wastage of the energy content and valueless release of emissions to air. The use of the process gases in steam and power generation represents a great improvement over flaring in terms of overall efficiency. In existing boilers and gas turbines, improvements in plant efficiencies in converting the gases to useful steam, hot water or electricity are brought about by improvements in technology. The application of these new technologies is dependent on the plant configuration and cost-benefit analysis.

Commercial large combustion plant installations are generally optimised for energy output, whereas those in or associated with an integrated steelworks are operated to utilise the process gases made available and must accommodate variations in the amounts and compositions of the fuels, often at very short notice (less than a minute). The production of the process gases from the coke oven and from the blast furnace is continuous and sudden interruptions of supply due to problems at these plants are generally infrequent; the variability of supply volumes originates mainly from variations in demand from the higher-priority users of the process gas in the iron and steelworks. This is especially important for COG, due to the large volumes and high calorific value.

Despite the use of techniques such as different burners for each gas, a plant design to accommodate different gases with varying thermal capacity, and, in many cases, extensive control systems, continuous changes in the process gases can still result in a less than optimal boiler efficiency. The efficiency of boilers utilising iron and steel process gases is further reduced by the need to maintain flue-gas temperatures in excess of their dew point.

Some of these aspects of plant operation are shown in Figure 7.34, where the hourly average thermal input is plotted over a three-month period for a 108 MW_{th} boiler designed to utilise mostly BFG with an addition of COG to boost the overall LHV, plus heavy fuel oil (HFO) for flame stabilisation or plant protection.

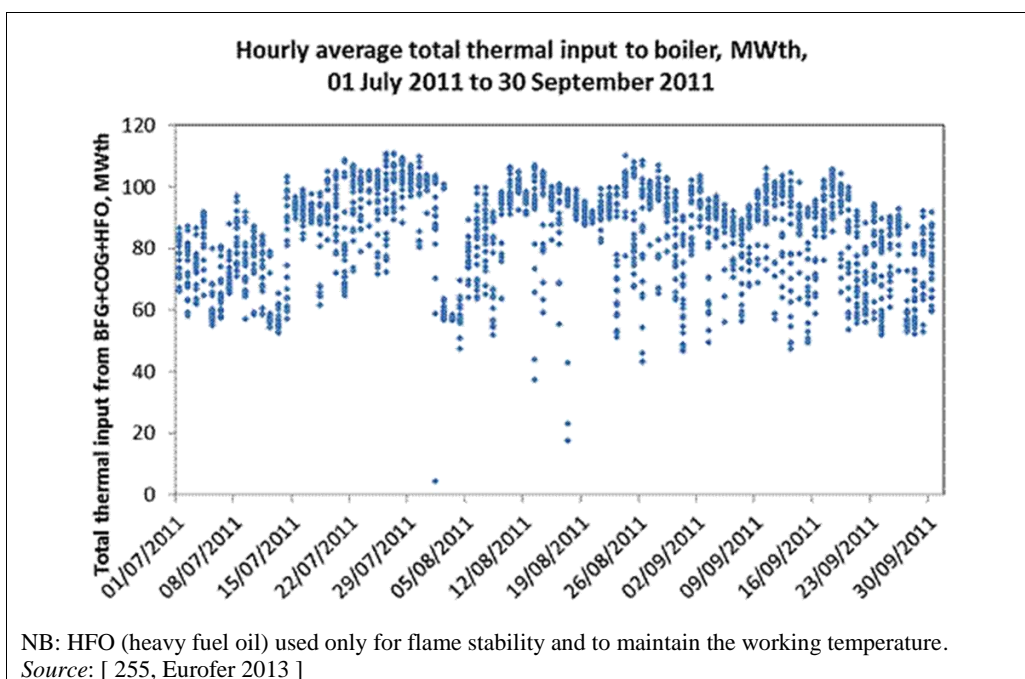

Figure 7.34: Hourly average data for the thermal input to a boiler using BF gas, COG and HFO over a period of three months

The majority of plants operating on iron- and steelworks process gases do not work close to their total rated thermal input, a significant factor affecting total efficiency.

Figure 7.35 shows how the BFG and COG can vary on an hour-by-hour basis within a two-week period.

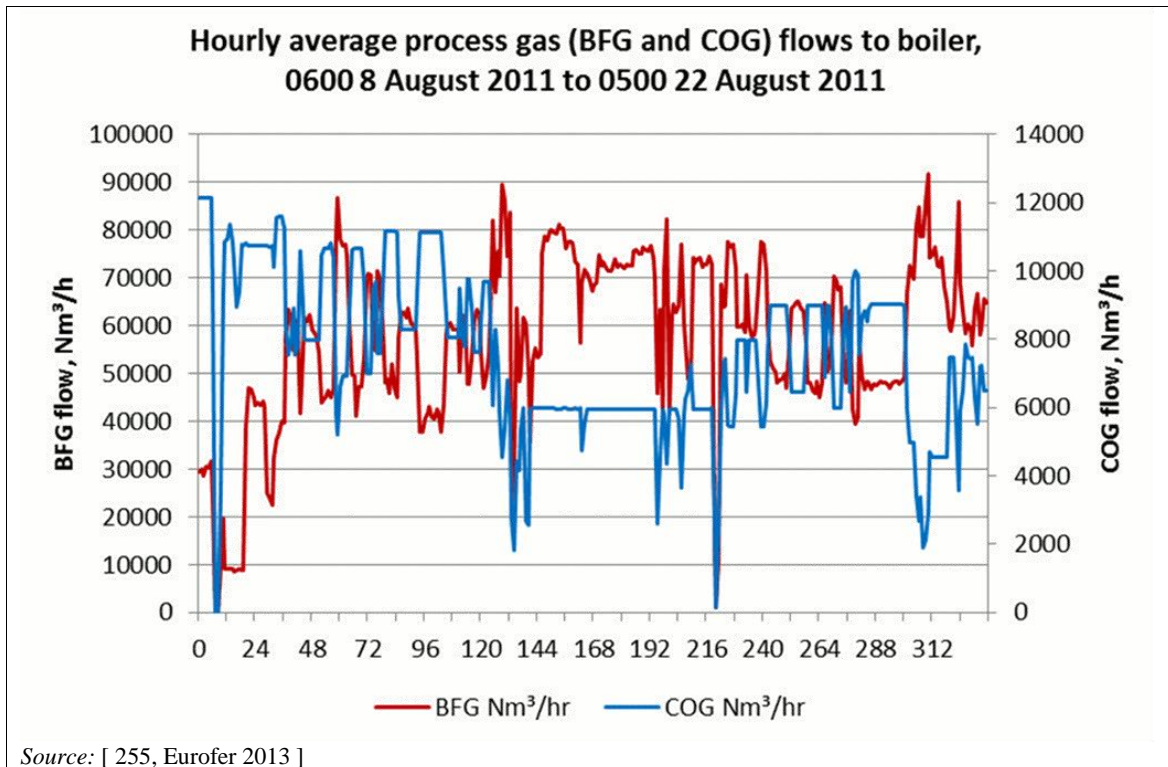

Figure 7.35: Hourly average inputs of BF gas and COG to a boiler over a two-week period

Despite the large variations in the availability of the process gases, the overall thermal input to the boiler (Figure 7.36) is maintained at about 90 MW_{th} when the blast furnace is operating in a stable manner. For the 61 European plants that submitted data for the LCP BREF review, an annual estimate of the total thermal input was calculated. This analysis showed that, on average, the plants have an equivalent full load factor of 73.7 %, with a range between 97.5 % and 46.7 %.

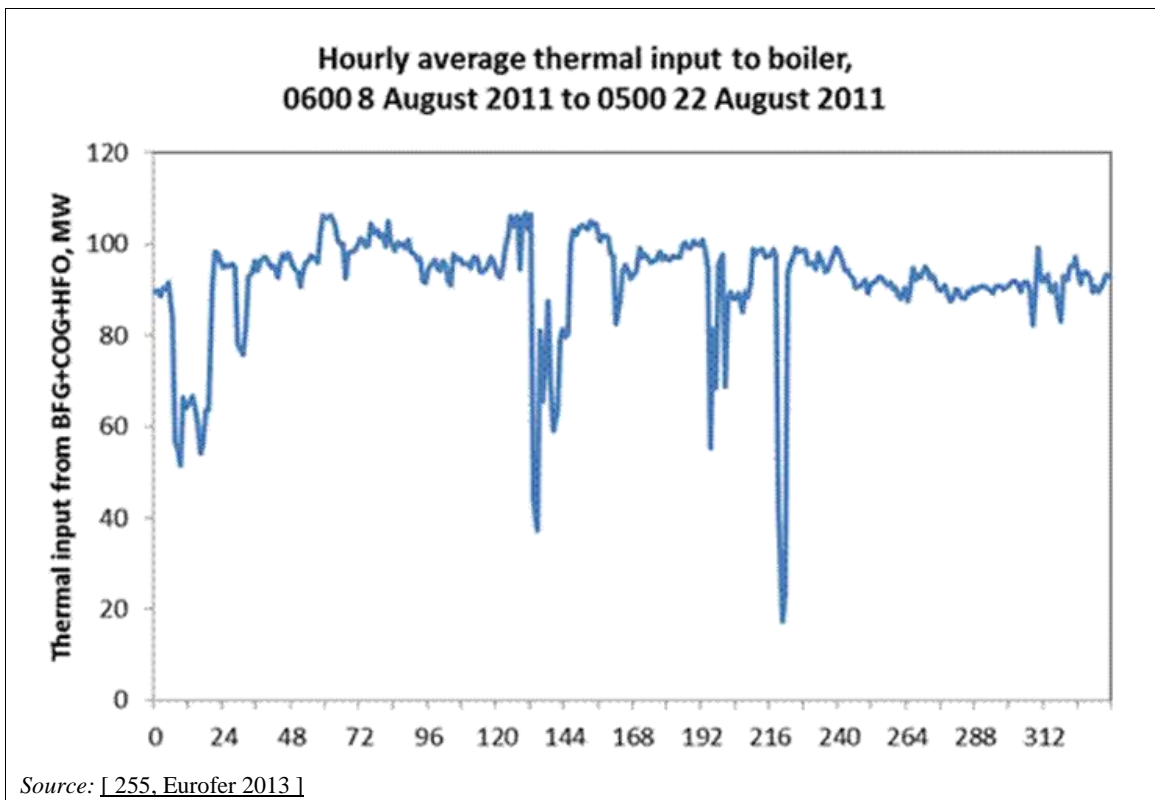

Figure 7.36: Hourly average thermal inputs of BF gas, COG and HFO to a boiler over a two-week period

Plants with DeNO_x systems or other flue-gas treatment systems installed have lower net energy efficiency because of the energy consumption of these end-of-pipe systems (see Section 2.7.10.1).

The data collected by [3, LCP TWG 2012] show that the average operating net total fuel utilisation is 52.1 %, with a median value of 46.0 %, between a maximum of 83.6 % and a minimum of 28.0 %. The net operating total fuel utilisation is strongly dependent on the availability and type of process gases, which depends on the steelworks operation.

The more limited data for CCGTs indicate that these plants are operated differently from the boilers. The average operating net total fuel utilisation is 52.6 %, with a median value of 51.5 %, between a maximum of 82.2 % (mostly thermal output) and a minimum of 40.5 % (all electrical output).

Daily average data for one CCGT illustrates the different approach to operations compared with boilers. Figure 7.37 shows the daily average total thermal input to a CCGT made up of contributions from BFG, COG and BOF gas together with NG as an auxiliary fuel. In this case, the total thermal input from COG and NG is held relatively constant at about 60 % of the total thermal input, i.e. the NG is increased to compensate for a loss in COG and reduced when COG availability increases.

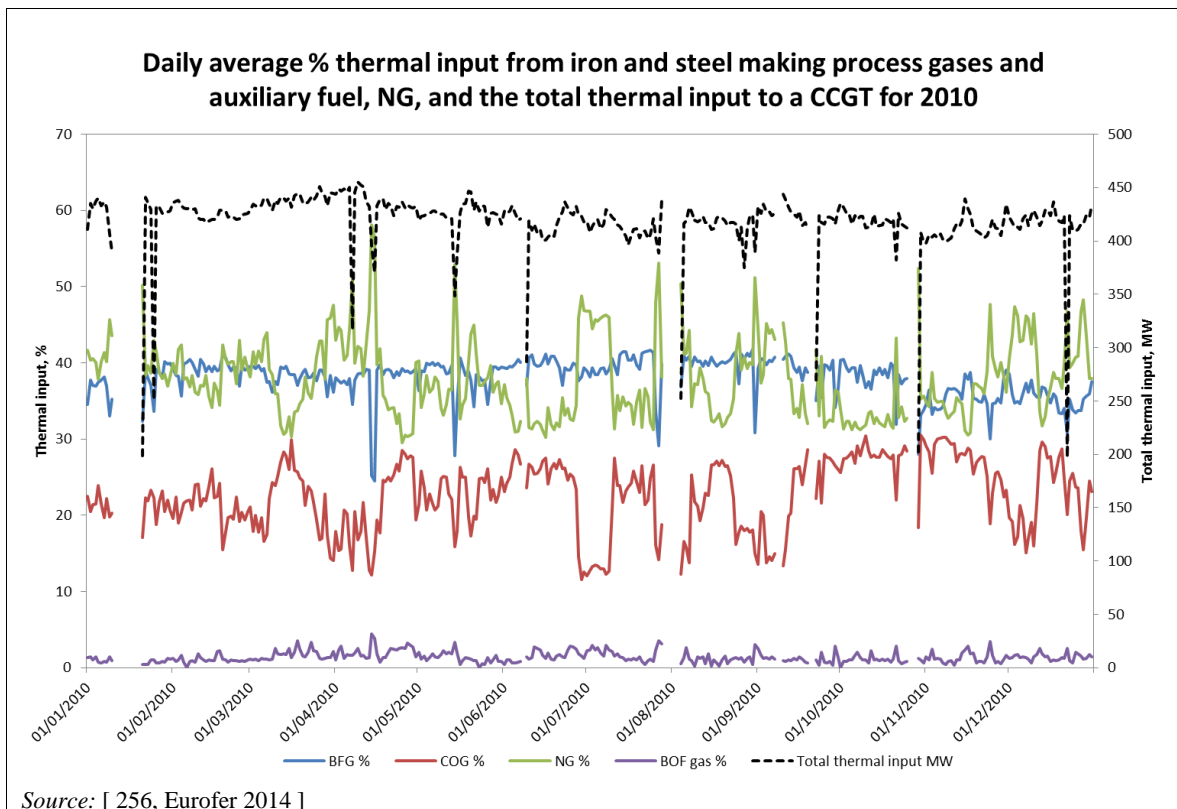

Figure 7.37: Daily average thermal inputs of BFG, COG and BOF gas plus NG auxiliary fuel to a CCGT in 2010

7.3.2.3 Emissions to air

The very broad range of different combinations of process gases that can be used influences the emission of SO_x , NO_x and particulates by an integrated steelworks boiler/power plant.

To illustrate the effects that the various process gases have on emissions, detailed plots of the thermal inputs of BF gas, COG and HFO as auxiliary fuel for a boiler designed to operate on a high proportion of BF gas, and the impact on emissions, are presented in Figure 7.38 and Figure 7.39 respectively. Compared with the process gas flows considered earlier, the COG thermal input is remarkably stable, but the thermal input from the BF gas shows a high degree of variability. HFO is used when the BF gas input is very low or not available, and also when the combined thermal input from the BF gas and COG is insufficient to maintain the minimum thermal input.

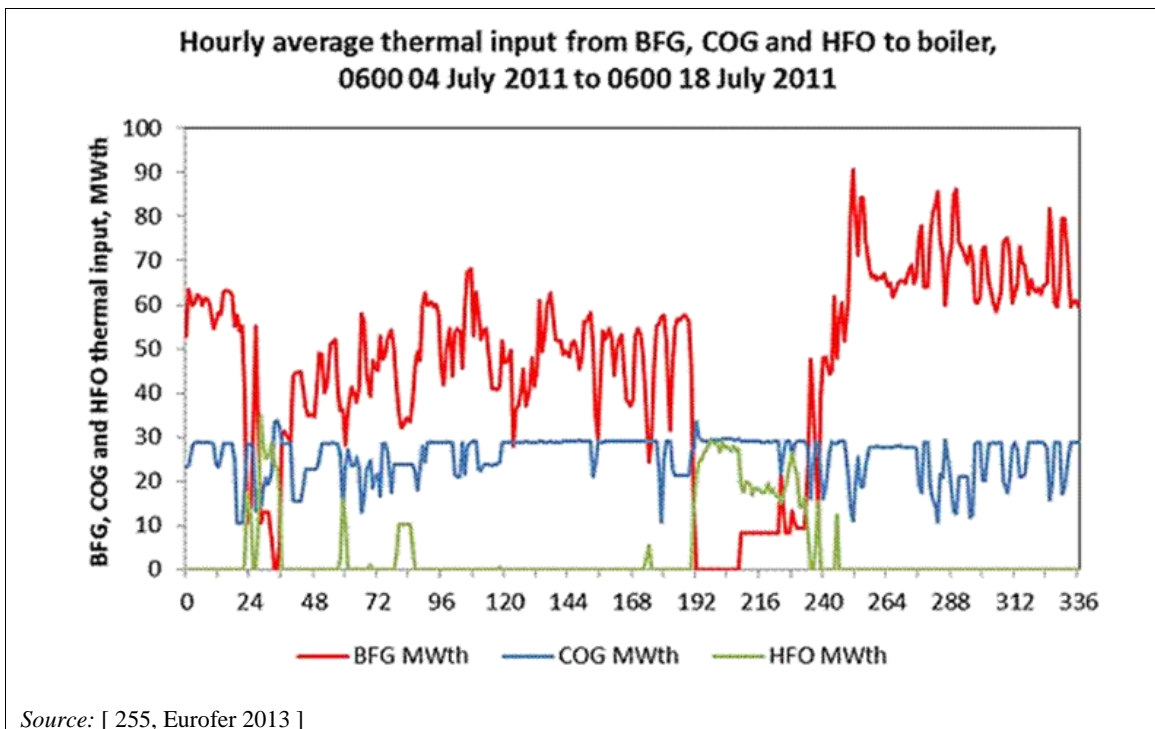

Figure 7.38: Hourly average thermal inputs of BF gas, COG and HFO to a boiler over a two-week period

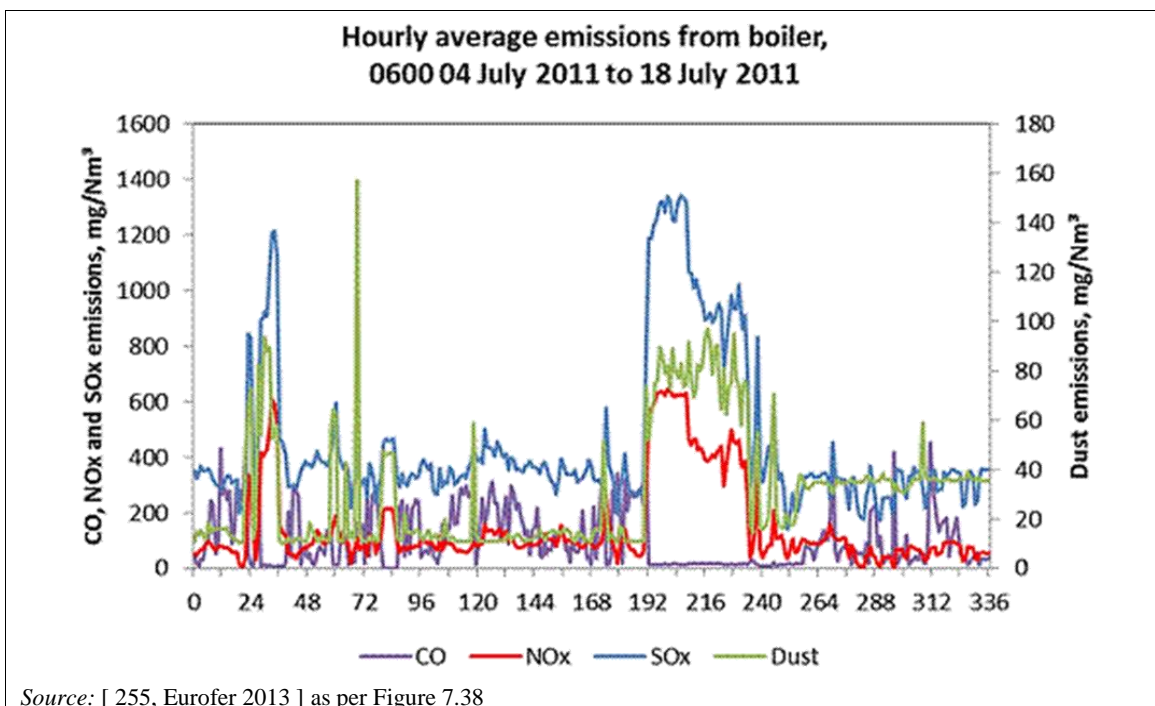

Figure 7.39: Hourly average emissions of dust, NO_x, SO_x and CO (reference 3 % O₂) from a boiler fired on BF gas and COG with HFO addition as required over a two-week period

Another example is given in Figure 7.40 and Figure 7.41 where, for the 25-day period represented, a boiler experiences significant, independent variations in both COG and BFG resulting in a high variation in the total thermal input to the boiler. These figures illustrate the relationship between the relative proportions of process gases combusted and the level of NO_x and SO_x that can be generated by the boiler.

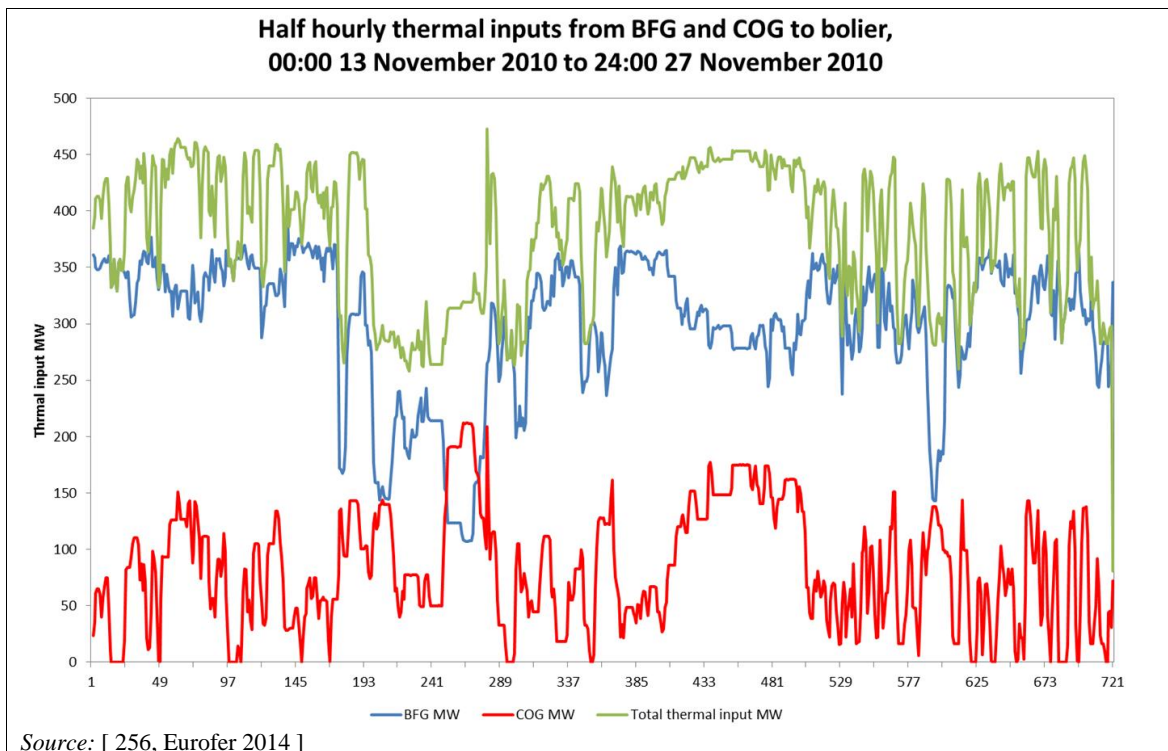

Figure 7.40: Half-hourly average thermal inputs of BFG and COG and total thermal input to the boiler over a 25-day period in November 2010

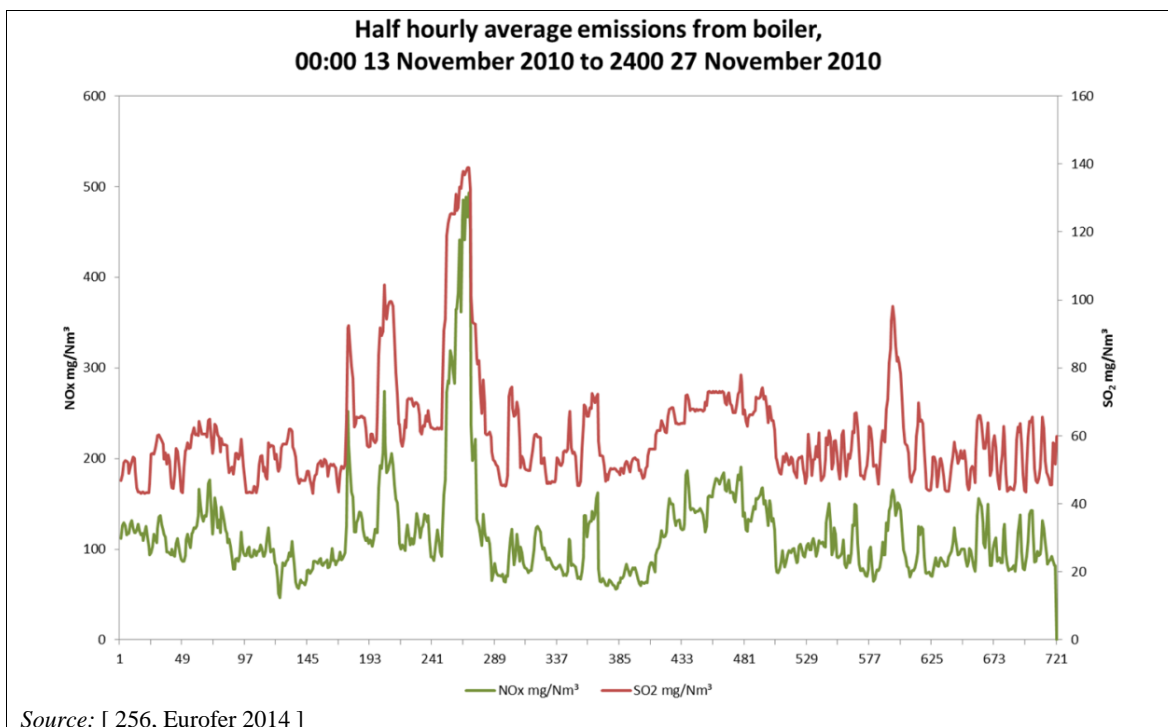

Figure 7.41: Half-hourly average emissions of NO_x and SO₂ (reference 3 % O₂) from a boiler fired on BFG and COG over a 25-day period in November 2010, as per figure 7.40

An example of the relationship between the I&S process gases combusted and the resultant levels of NO_x, CO, dust and SO_x generated by a CCGT is given in Figure 7.42 and Figure 7.43. In this case the correlation is less clear since the variations in input gases experienced by the CCGT are more constrained by the fuel quality requirements for gas turbines.

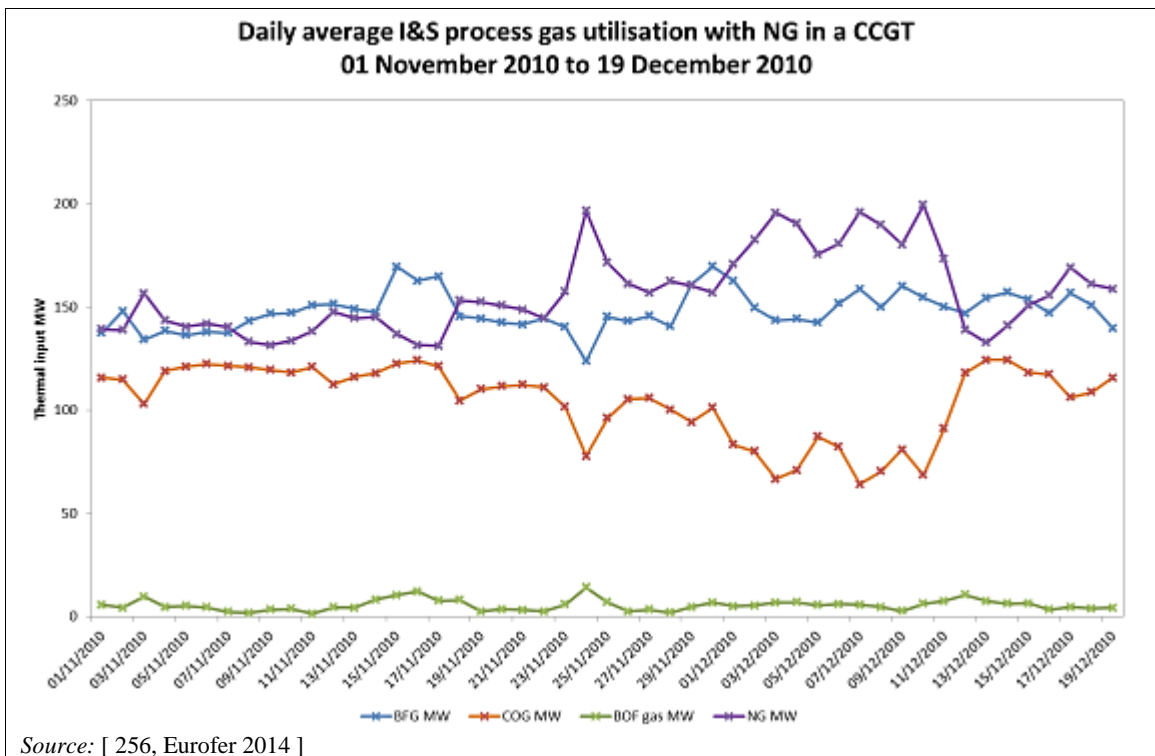

Figure 7.42: Daily average thermal inputs of I&S process gases plus NG and total thermal input to a CCGT over a 50-day period

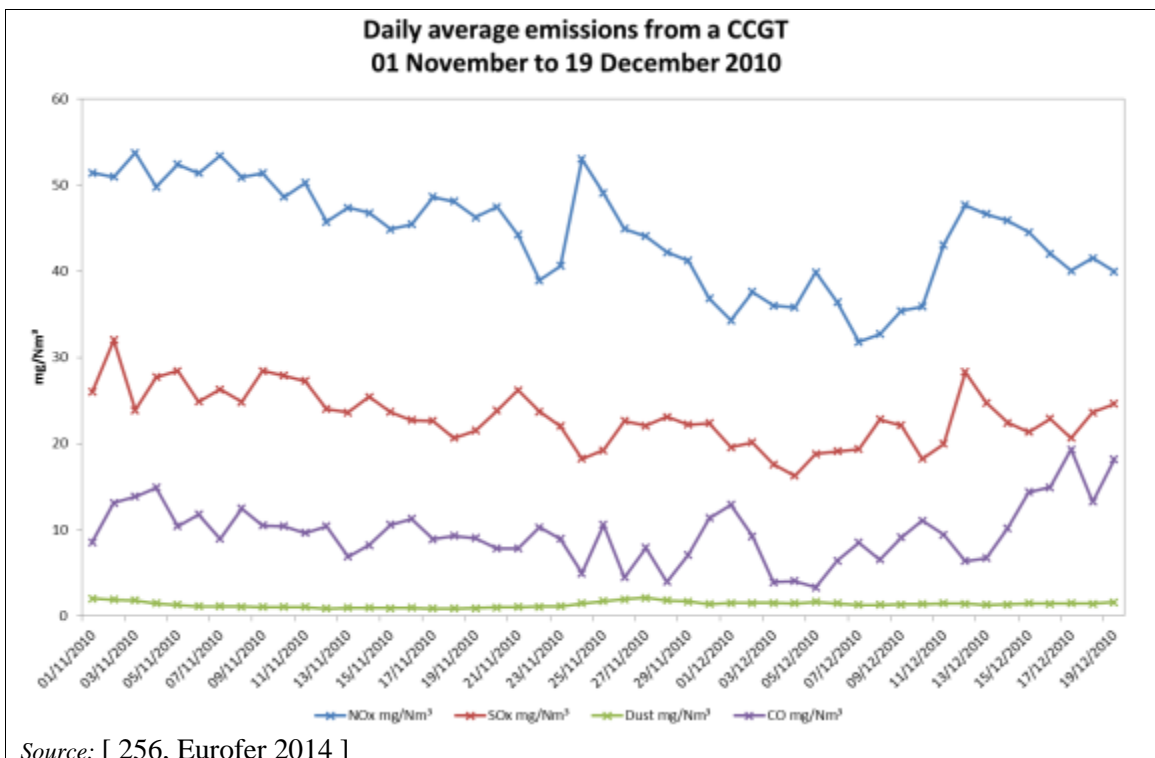

Figure 7.43: Daily average emissions from a CCGT over a 50-day period, as per figure 7.42

NO_x

NO_x emissions are generally monitored continuously. For boilers, the 10 highest NO_x emitting plants have annual average emissions ranging from 130 mg/Nm³ to 294 mg/Nm³ (at 3 % O₂) and use noticeably more auxiliary fuel (natural gas, oil, coal) in a year than those emitting less. The lowest NO_x emitting plants have annual average emissions range from 20 mg/Nm³ to

49 mg/Nm³ (at 3 % O₂) and are characterised by high levels of BFG use, averaging 82.7 % BFG on a thermal input basis. The highest hourly emission is 1174 mg/Nm³ (at 3 % O₂).

Plants operated with SCR DeNO_x systems have annual average NO_x emissions ranging from 30 mg/Nm³ to 84 mg/Nm³ (at 3 % O₂) and a maximum emission level of 566 mg/Nm³ (at 3 % O₂) on a half-hourly average basis.

The relationship between NO_x generation and the relative thermal inputs of combusted BFG and COG can be seen in an example in Figure 7.44. This figure shows an increase in the NO_x emission when the availability of BFG decreases, which is mirrored by an increased percentage of COG input. More information about typical NO_x emissions from COG combustion without any primary technique is given in Section 2.2.1.2.1.4 of the Iron and Steel BREF.

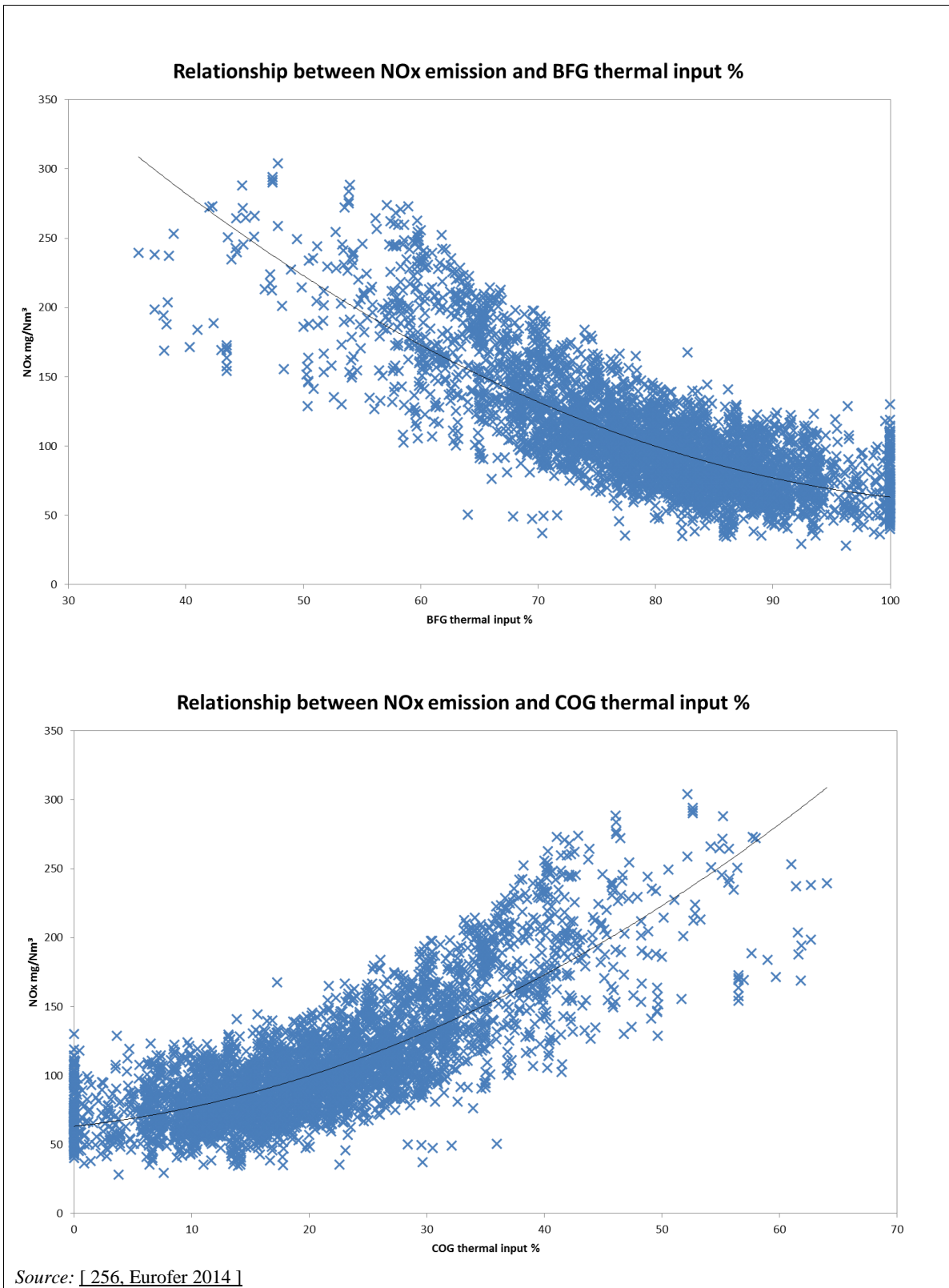

Source: [256, Eurofer 2014]

Figure 7.44: Relationship between NO_x emissions and the relative thermal inputs to the boiler of BFG and COG using hourly average data over a three-month period

The NO_x emissions from another boiler are shown in Figure 7.45, where the variations in NO_x emissions are shown when the boiler is operating on gas mixtures with varying base mix proportions.

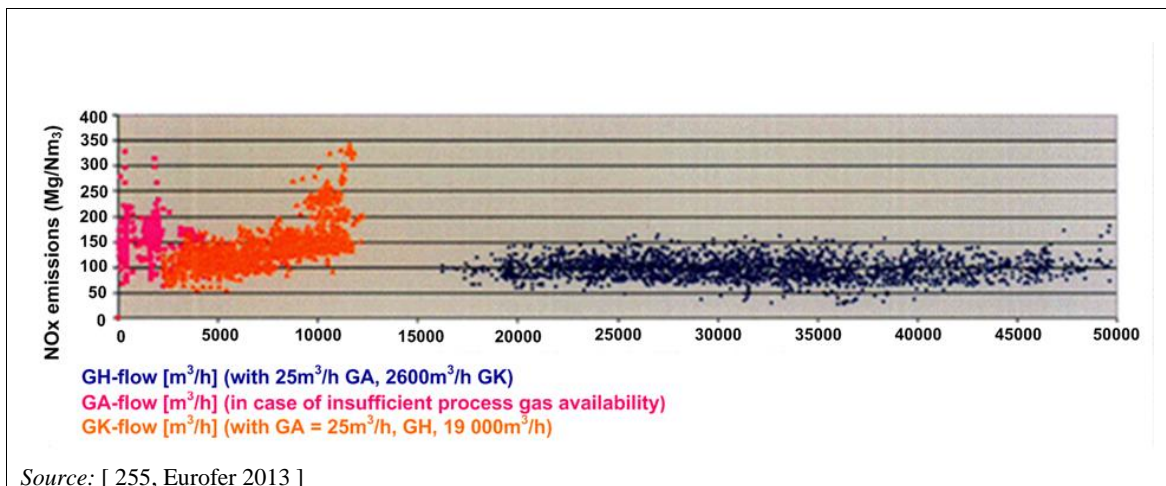

Figure 7.45: NO_x emissions (mg/Nm³) against the gas flows (m³/h) for a boiler using three different base gas mixes

In Figure 7.45, the data marked by pink points represent the situation where, for numerous operational reasons in the steelworks, process gas is not available and natural gas (NG) is used to maintain steam production. The orange points indicate the situation where the base mixture comprises 25 Nm³/h NG and 20 000 Nm³/h BF gas and a large amount of COG (larger than the 'standard amount' indicated by the blue points), which is the principal variant. The blue points indicate the situation where the base mixture comprises a minimal amount of NG, plus 2 500 Nm³/h COG and the boiler fires mostly BF gas.

This boiler was designed to utilise mostly BFG and, in this situation (blue points), the emission of NO_x is contained within a band around 100 mg/Nm³. The burners were designed to work best on this gas mixture, but they are also able to burn different gas mixtures as necessary. This leads to a compromise design, where the emissions of NO_x are affected by greater use of the higher calorific value gases, COG and NG. In particular, the increase in NO_x emissions with the increase in COG use (orange points) can be noticed. With both COG and NG, the flame temperature increase explains the NO_x emission increase. For the COG, a large percentage of hydrogen is the main cause for the elevated NO_x levels.

For the eight gas turbines that reported data for the LCP BREF review, the annual average NO_x emission ranges between 22 mg/Nm³ and 98 mg/Nm³ (at 15 % O₂). Two of the gas turbines are fitted with SCR and report yearly average NO_x emissions between 22 mg/Nm³ and 55 mg/Nm³ (at 15 % O₂). In general, the gas turbines are operated on higher levels of NG (average 44.9 % on a thermal input basis) than the boilers (7.9 % on a thermal input basis). The maximum NO_x emission level on an hourly average basis is up to 277 mg/Nm³ (at 15 % O₂). The gas turbines fitted with SCR have a maximum hourly NO_x emission level of 59 mg/Nm³ (at 15 % O₂). Figure 7.46 presents daily data combined for three CCGTs to illustrate the effect of COG on the NO_x generation. In this case, variations in the gas mixtures are less pronounced and, where a significant quantity of NG is used to maintain the thermal input, the correlation with NO_x emissions is unclear.

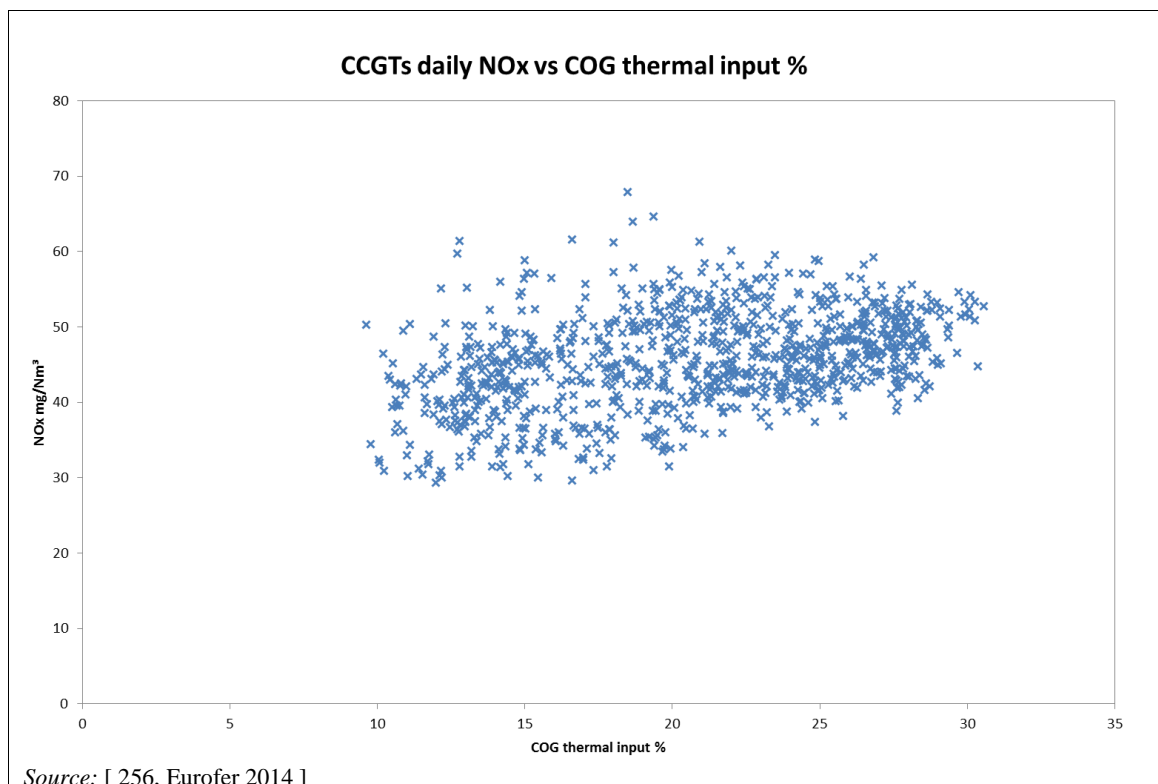

Figure 7.46: NO_x emissions and relative thermal input for a combination of three CCGTs combusting COG, using daily average data for 2010

CO

Boilers fall into two groups: those that have undergone extensive retrofits or significant burner design changes after the year 2000, and those that have not. A separation of these two groups in terms of the annual average CO emission level can be identified at the level of 65 mg/Nm³ (at 3 % O₂). The average CO emission level of the plants emitting below this emission level is 10.7 mg/Nm³, and for those above, 170 mg/Nm³. The median value for all the data is 16.5 mg/Nm³. On an hourly or half-hourly average basis, two plants co-firing non-gaseous auxiliary fuels have a maximum CO emission value of around 1 500 mg/Nm³ (at 3 % O₂). Excluding these plants, the maximum falls to 500 mg/Nm³ (at 3 % O₂) on an hourly or half-hourly average basis. Plants that have been more recently retrofitted have maximum emission levels up to 300 mg/Nm³ (at 3 % O₂).

For gas turbines, the annual average CO emission levels range between 0.59 mg/Nm³ and 20 mg/Nm³ (at 15 % O₂), with a maximum value of 376 mg/Nm³ (at 15 % O₂) on an hourly or half-hourly basis.

There appears to be no correlation between the CO generation levels and the types of gases used. Higher CO emissions can result from higher than normal pressures in the process gas supply, causing the process gas with a high CO content to break through into the burner system and thus travel downstream in the flue-gas.

SO_x

While the level of H₂S that can be contained in the COG is controlled by means of techniques described in the IS BREF (2012), the total S level is low in BFG (see Figure 7.21) and generally present only at very low levels in BOF gas. The desulphurisation plants at the coke ovens require regular maintenance, during which the level of S in the COG can be greater than when the coke ovens operate. In addition, problems at the desulphurisation plant can cause upsets in the emission of SO_x. These situations are recognised as other than normal operating conditions.

In very general terms, higher emissions of SO_x are associated with plants that operate with auxiliary fuels such as coal, gas oil and/or HFO.

The relationship between SO_2 emissions and the relative thermal inputs of combusted BFG and COG can be seen in an example in Figure 7.47. This figure shows an increase in SO_2 emissions when the availability of BFG decreases, which is mirrored by an increased percentage of the COG input.

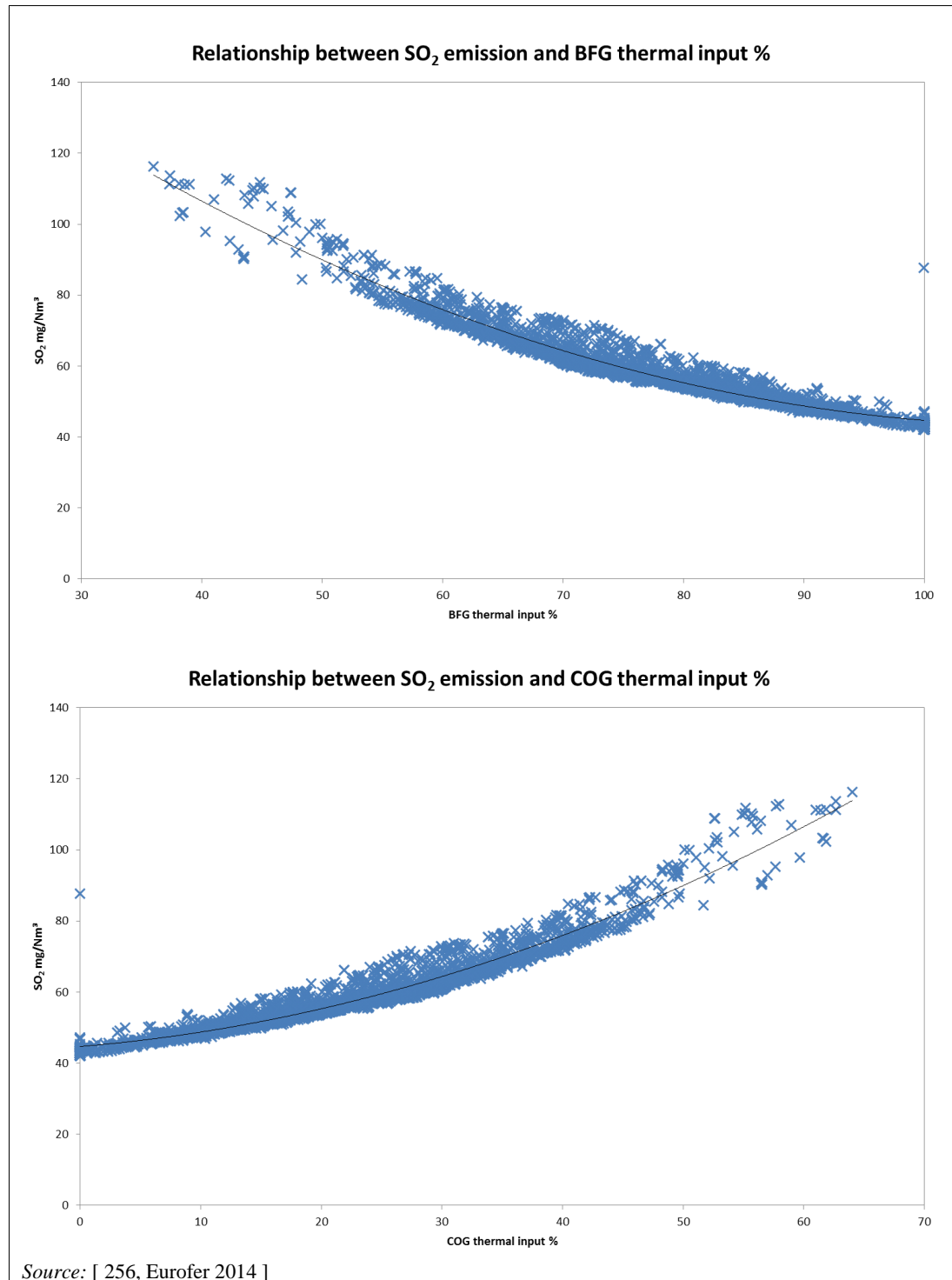

Figure 7.47: Relationship between SO_2 emissions and the relative thermal inputs to the boiler of BFG and COG using hourly average data over a three-month period

Figure 7.48 presents daily data combined for three CCGTs to illustrate the effect of COG on SO₂ generation. In this case, a clear correlation between the thermal input from COG and SO₂ emissions is not observed.

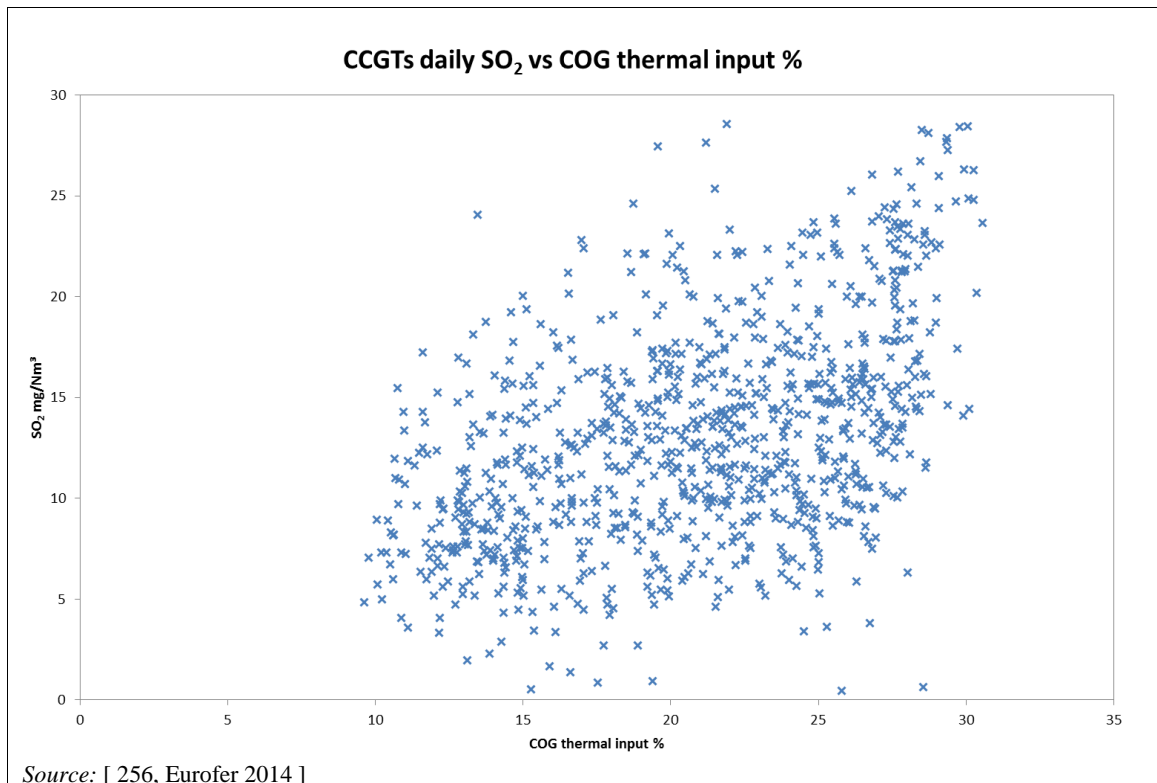

Figure 7.48: Relationship between SO₂ emissions and COG inputs to 3 CCGTs using daily average data for 2010

Dust

The levels of dust contained in the iron and steel process gases used in the combustion processes are controlled below 10 mg/Nm³ for BFG and BOF gas (< 50 mg/Nm³ in IS BREF (2012)), and techniques used to recover the valuable products in the raw COG generally ensure dust levels in the COG lower than 10 mg/Nm³. Dust emissions from boilers firing iron and steel process gases are largely defined by these techniques. However, it should be noted that variations in dust emissions might reflect problems occurring in the process gas production processes, e.g. a problem with a blast furnace.

7.3.3 Techniques to consider in the determination of BAT for the combustion of iron and steel process gases

This section describes techniques (or combinations thereof), and associated monitoring, considered to have the potential for achieving a high level of environmental protection in the activities within the scope of this document. The techniques described include both the technology used and the way in which the installations are designed, built, maintained, operated, and decommissioned.

It covers process-integrated techniques and end-of-pipe techniques. Waste prevention and management, including waste minimisation and recycling procedures, are also considered. Furthermore, techniques for reducing the consumption of raw materials, water, and energy are covered.

Annex III to the Industrial Emissions Directive lists a number of criteria for determining BAT, and the information within this chapter addresses these considerations. As far as possible, the standard structure of Table 3.4 is used to outline the information on each technique, to enable a comparison of techniques and the assessment against the definition of BAT given in the Industrial Emissions Directive.

This section does not necessarily provide an exhaustive list of techniques that could be applied in the sector. Other techniques may exist, or may be developed, which could be considered for the determination of BAT for an individual installation.

In this section, the techniques to be considered have only been fully described when they are specific to the considered combusted fuel or applied combustion process (combustion of iron and steel process gases). Indeed, for most of the techniques, general descriptions are already presented in Chapter 3. Therefore, in order to avoid repetition, for those general techniques already described in Chapter 3, only the additional information that is specific to the combustion of iron and steel process gases is reported here in synthesis tables.

The energy balance of an integrated iron- and steelworks is complex and this, together with the uniquely different plant layouts, results in each works having its own systems for optimising energy usage and hence gas distribution across the consuming plants. The objective is to maximise the productive use of the I&S process gases, minimise the use of auxiliary fuels, and optimise the specific energy consumption within the inherent constraints of the system. In order to achieve this goal, an adequate system is put in place to simultaneously address the technical possibilities, the economics and organisational issues.

The boilers combusting iron and steel process gases that have been used to illustrate the performance of techniques to consider in the determination of BAT are sized between 50 MW_{th} and 1220 MW_{th} and were commissioned mostly between 1953 and 1992, with four more commissioned between 2002 and 2010. They are operated, generally, between 4 500 h/yr and 8 760 h/yr (two exceptions are Plant 009 and Plant 630-1 which respectively operated for 1 000 hours and 3850 hours in the reference year), with an equivalent full load factor between 42 % and 99 %.

The CCGTs that reported data used to illustrate the performance of techniques to consider in the determination of BAT are sized between 85 MW_{th} and 440 MW_{th}, and were commissioned between 1989 and 2001. They are operated, generally, between 6 500 h/yr and 8 200 h/yr (one exception is Plant 008 which operated for 1 400 hours in the reference year), with an equivalent full load factor, generally, above 90 % (one exception is Plant 616, with an equivalent full load factor of 65 %).

7.3.3.1 Techniques to increase energy efficiency**7.3.3.1.1 General techniques to increase energy efficiency**

General techniques to be considered in the determination of BAT for increasing the energy efficiency of natural gas-fired plants or coal-fired plants (Table 7.9, Table 5.27 and Table 5.28) are also to be considered in the context of combustion plants firing iron and steel process gases. Further details on the associated environmental performance, operational data, and applicability or economic constraints are given below.

Environmental performance and operational data**Energy efficiency for plants combusting iron and steel process gases alone or in combination with other gaseous and/or liquid fuels**

Techniques such as preheating of the combustion air and/or fuel gases are considered an effective option to increase efficiency. These techniques are relevant for any newbuild combustion plant and when a substantial refurbishment is undertaken. There are various methods to preheat the process gases. These may include preheating of the gas by feed-water exchangers before combustion. The feed-water temperature is decreased in the boiler economiser, which enables a lower final flue-gas temperature and higher efficiency. Preheating of the process gases may also be achieved by utilising steam from the low-pressure stage of the steam turbine and the use of hot flue-gas in the preheaters. Plants 595V–596V, 621, 623V to 630V, and 1V to 9V have successfully deployed this technique.

Efficiency gains from steam turbine modifications have also been reported. In one example (Plant 607V) a high pressure-low pressure steam turbine retrofit led to a capacity increase of more than 13 MW (about 1.5 % increase in capacity). The cost in 2008 was about EUR 10 million, and the environmental benefit was the lesser input of gas per unit of energy produced. In addition, there was a positive economic incentive.

The installation of a new expansion turbine by Plants 602V–606V in 2012 to replace a redundant three-bar steam supply facilitated the modernisation of the turbine control technology, with a change from constant pressure to variable pressure resulting in a more economic process. The introduction of a new lambda-control technology for fuel-combustion air control for all three I&S process gases also gave an increase in energy efficiency by reducing flue-gas losses.

For new plants and for retrofitting existing plants where an installed gas turbine has sufficient capacity, the use of a combined cycle (gas turbine with steam turbine) could give an increase in the efficiency of the process and results in primary energy savings. In order to financially justify such a development, there has to be a demand for the additional heat, as is the case for Plant 8V.

The production of low-pressure steam for district heating is applicable for LCPs close to urban areas and where there is a demand from a third party. By using extracted low-pressure steam from the steam turbine for hot water production, the overall efficiency can be increased as the low-pressure steam would otherwise produce electricity at only a low efficiency. In addition to greater fuel energy utilisation, income can be generated by supplying district heating, and emissions to air in the district are reduced. Plants 1V to 9V in Austria and Plants 619 to 621 in Sweden supply district heating schemes.

Figure 7.49 and Figure 7.50 respectively show the operating energy efficiencies of boilers and CCGTs combusting iron and steel process gases. The type of energy produced depends on the site needs.

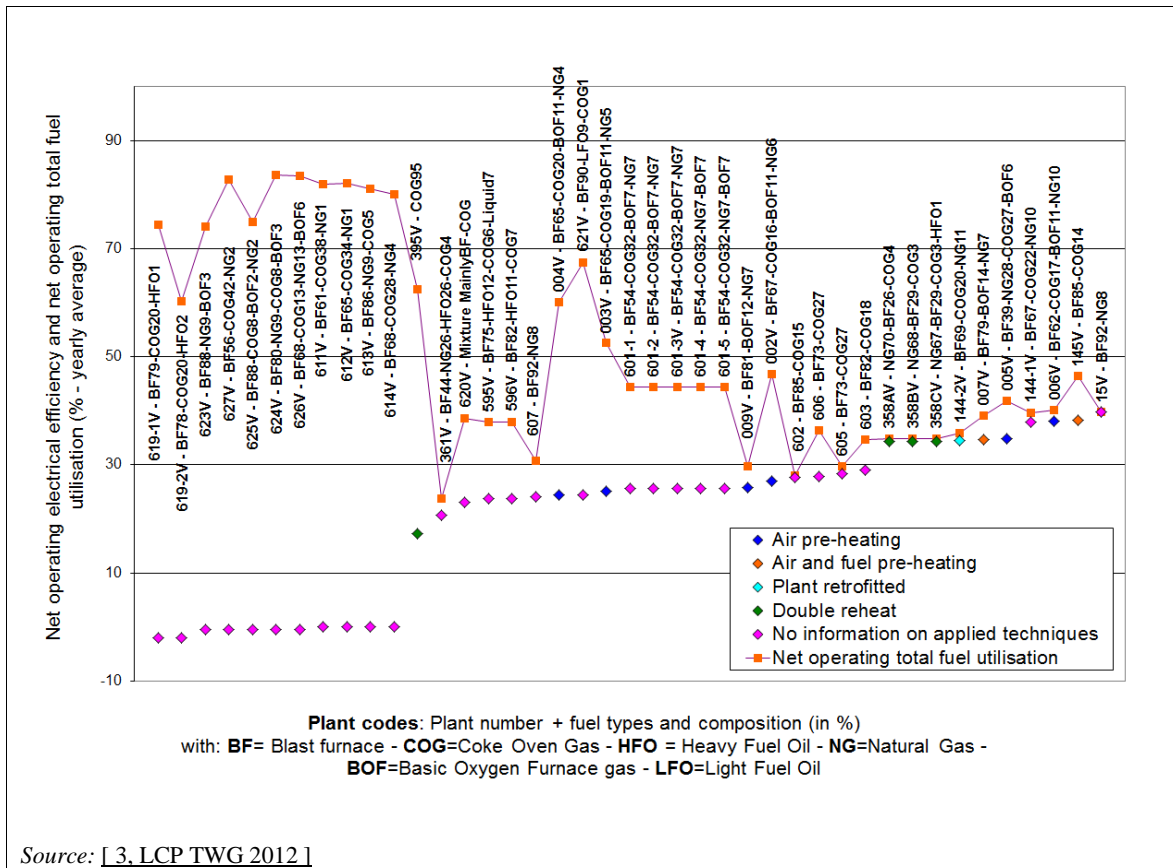

Figure 7.49: Operating energy efficiencies of boilers firing iron and steel process gases in combination with other gaseous/liquid fuels for 2012

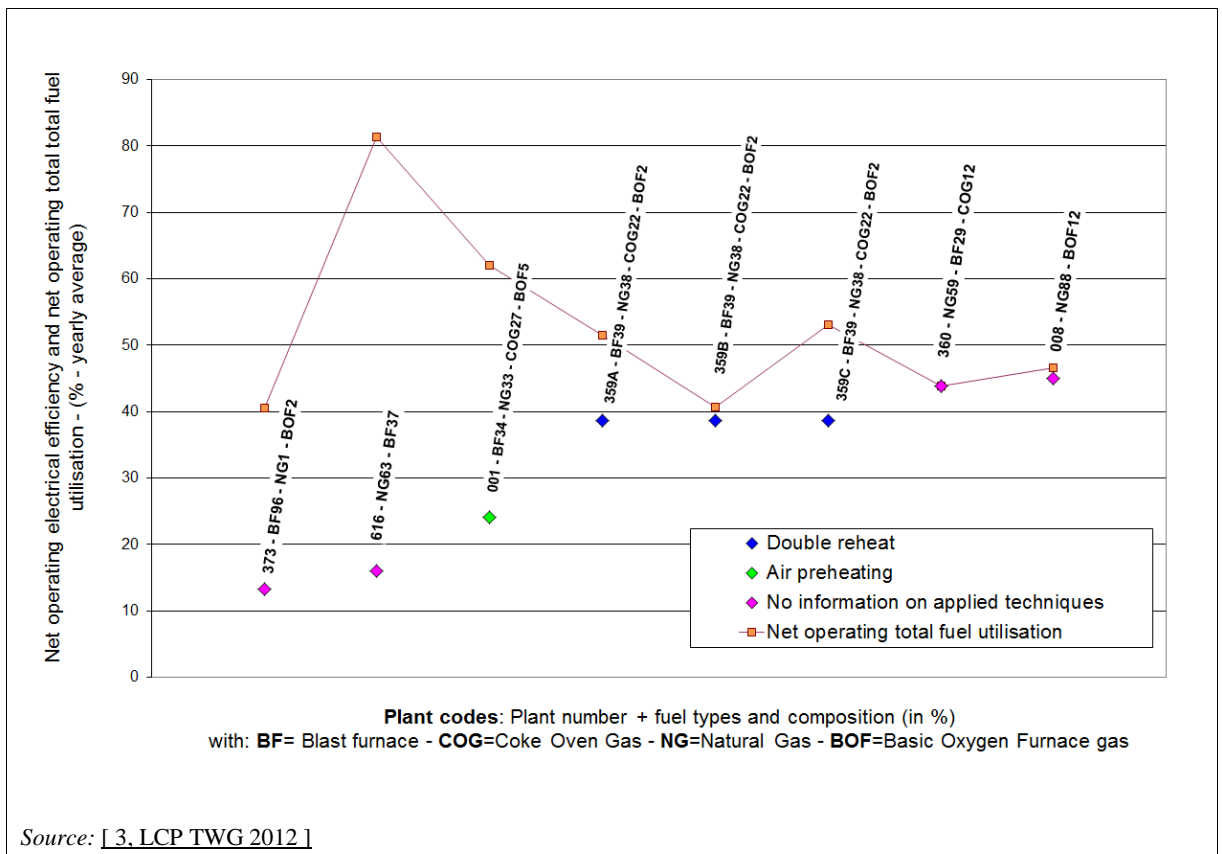

Figure 7.50: Operating energy efficiencies of CCGTs firing iron and steel process gases in combination with other gaseous fuels for 2012

In addition to these operating levels, information was submitted on design net electrical efficiencies with levels between 32.5 % (Unit 361) and 42.5 % (Unit 15).

As for gas turbines firing process gases from the iron and steel industry, only one example of design net electrical energy efficiency was reported, by Unit 360 with 47 % compared with the operating yearly value of 43.9 % reported in 2012. Compared with natural gas firing, the design net electrical energy efficiency is expected to be lower when combusting iron and steel process gases because of the lower calorific value.

[66, TWG Task Force on Energy Efficiency 2014]

7.3.3.1.2 Process gas management system

Description

Process gas management systems are designed to maximise the productive use of the I&S process gases. They enable the process gases to be directed to the combustion plants depending on the process gases availability, as those are distributed in order of priority to the consuming plants in the steelworks.

Technical description

Combustion plants using I&S process gases are integrated into any system designed to achieve the most efficient use of these gases across all of the consuming plants of the industrial installation. To optimise both energy efficiency and environmental emissions, these combustion plants are included in a process gas management system that considers the whole integrated site, instead of each process as a stand-alone unit. The most important energy flows and combustion processes are monitored online. The sophistication of these systems reflects the operational complexity of the works and incorporates technical, economic and managerial logic within model-supported systems with extensive levels of IT, integrated with measurement and control technologies. With a process gas management system, the gases can be used in order of priority in the iron and steel processes and then in the combustion plants, ensuring flare losses of all process gases are reduced.

Achieved environmental benefits

The more consistently and efficiently the process gases are used in the steelworks applications, the more regular the flows of gases to the combustion plants are, leading to a more efficient use of the available gases in the generation of steam and electricity. This is particularly relevant where there is great variability in the calorific value of the process gases.

An increase in energy efficiency reduces the emission levels for each unit of energy utilised and can contribute to reducing the use of fossil fuels in the production of steam, heat and electricity.

Environmental performance and operational data

Process gas management systems have operated for many years, often since the commissioning of the plant. What changes is the complexity of the calculations that can be made and the speed at which they are made and followed through. This is an area where incremental changes are implemented, but it is unlikely that the improvements will result in clearly measurable effects

Cross-media effects

None.

Technical considerations relevant to applicability

Applicable in integrated iron- and steelworks.

Economics

There are continuous cost requirements to maintain, upgrade and refurbish the meters and hardware associated with the application of these systems. Additionally, costs are associated with the maintenance and upgrading of the computing hardware and software associated with

the operation of the management systems. There are, however, economic advantages to be gained from the operation of these systems, through lower process energy use and reduced costs of imported fuels and electricity.

Driving force for implementation

There are economic and energy efficiency advantages to optimising utilisation of the process gases across the iron- and steelwork's network.

Example plants

All integrated iron and steel plants utilise process gas management tools.

Reference literature

No reference literature provided.

7.3.3.2 Techniques to prevent and/or control NO_x and CO emissions

7.3.3.2.1 General techniques for the prevention and control of NO_x and CO emissions when firing iron and steel process gases

General techniques to be considered in the determination of BAT for preventing and reducing NO_x and CO emissions to air from natural gas-fired plants (Table 7.10 and Table 7.11) are to be considered in the context of firing iron and steel process gases. Further details on the associated environmental performance, operational data and applicability or economic constraints are given below.

Environmental performance and operational data

For NO_x and CO emissions from plants combusting iron and steel process gases alone or in combination with other gaseous and/or liquid fuels

Figure 7.51 and Figure 7.52 respectively show the NO_x emissions from well-performing boilers and CCGTs combusting iron and steel process fuels. The boilers are fitted with a combination of primary techniques including LNB and/or SCR. The CCGTs are fitted with DLN, steam injection when using natural gas and/or an SCR. In the case of a high proportion of COG in the fuel mixture, which could lead to higher NO_x levels at the boiler outlet, the application of an appropriate (combination of) technique(s) (e.g. additional primary technique or SCR) may be possible.

The corresponding CO emissions are kept under 20 mg/Nm³ in the case of CCGTs, and in general below 25–50 mg/Nm³, with some plants emitting up to 100 mg/Nm³ and a few exceptions up to 225 mg/Nm³, in the case of boilers. No corresponding NH₃ emission value has been reported for the use of SCR.

The incorporation of an SCR system into an existing plant is an extensive process, both economically and practically, since the boiler into which it will be fitted has to be taken out of operation for a long period of time. Additionally, where heavy oil is used as an auxiliary fuel, the catalyst temperature has to be higher, close to 500 °C (normally 300–400 °C), which may be difficult to achieve for existing boilers.

With the SCR technique, NO_x removal can be as high as 80–95 %, but these levels can only be achieved in new LCPs, where the system has been accommodated from the design stage. When retrofitting an existing LCP, the unit generally has a lower efficiency, in the range of up to 65–75 %. Additionally, when considering the effectiveness of the SCR DeNO_x system applied to a boiler using I&S process gases, it has to be realised that the variations in the relative amounts of the different gases cause significant differences and fluctuations in the amount of thermal NO_x produced. This can result in the suboptimal operation of the system, if ammonia slip is to be

avoided. SCR requires the reactor to be either in constant operation or heated when the plant is not operational. The heating requires a constant flow of hot air so that the reactor can be started quickly when needed, but heating is also necessary to protect the catalyst material from water condensation. Where it is not possible to keep an SCR system operational at all times the cost of the investment, constant heating, operation and maintenance of the catalytic converter and the energy consumption for keeping the SCR system reactive may not be justified by the reduction in NO_x.

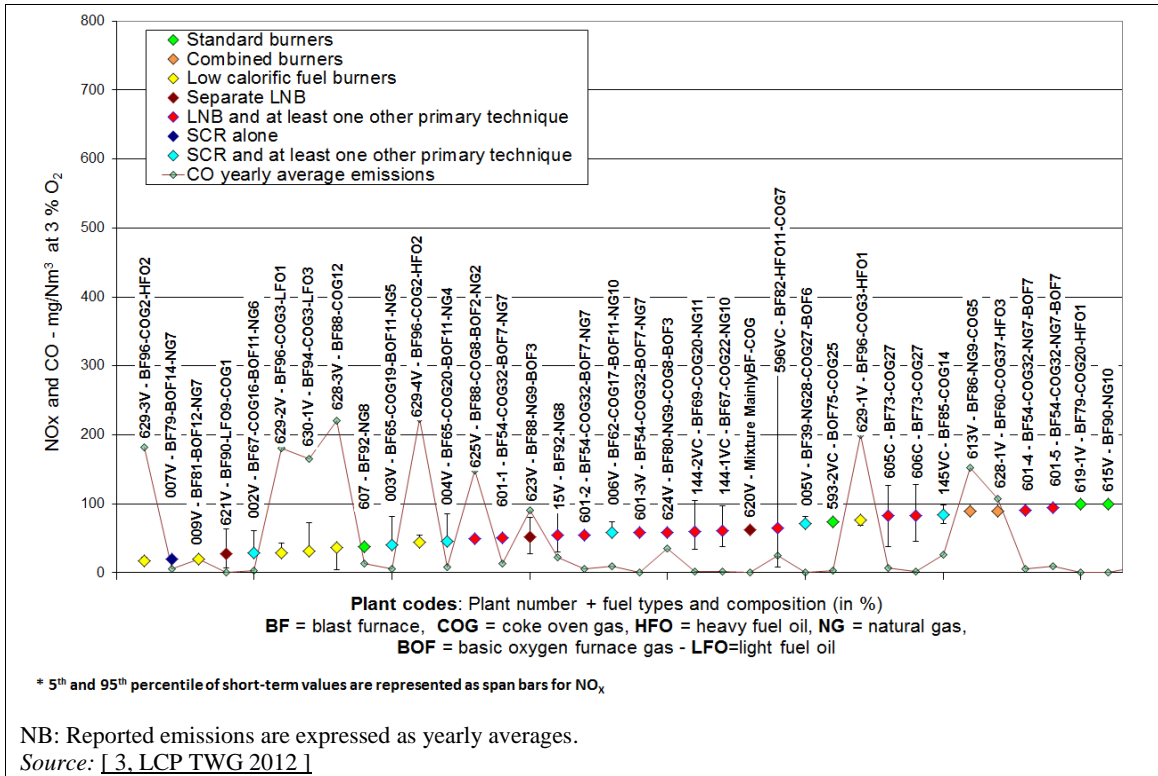

Figure 7.51: NO_x emissions from well-performing gas boilers combusting iron and steel process gases

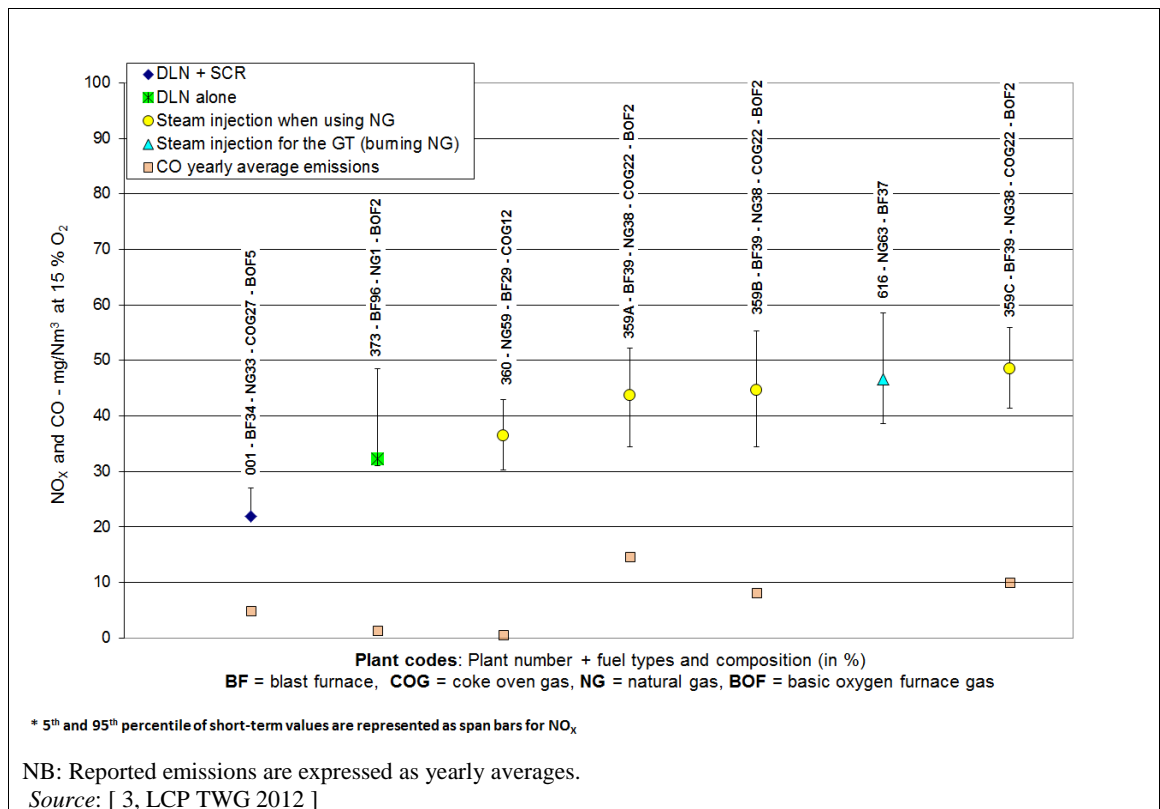

Figure 7.52: NO_x emissions from well-performing CCGTs combusting iron and steel process gases

For short-term NO_x emissions, the sector is specific as the composition and quantities of fuels/process gases that are combusted may vary from one day to another and within the same day from hour to hour and, at times, minute to minute:

- Besides the 95th percentile of hourly averages reported in Figure 7.51 for boilers, additional daily average data were collected by EUROFER in 2014 for another set of plants, as shown in Figure 7.53.

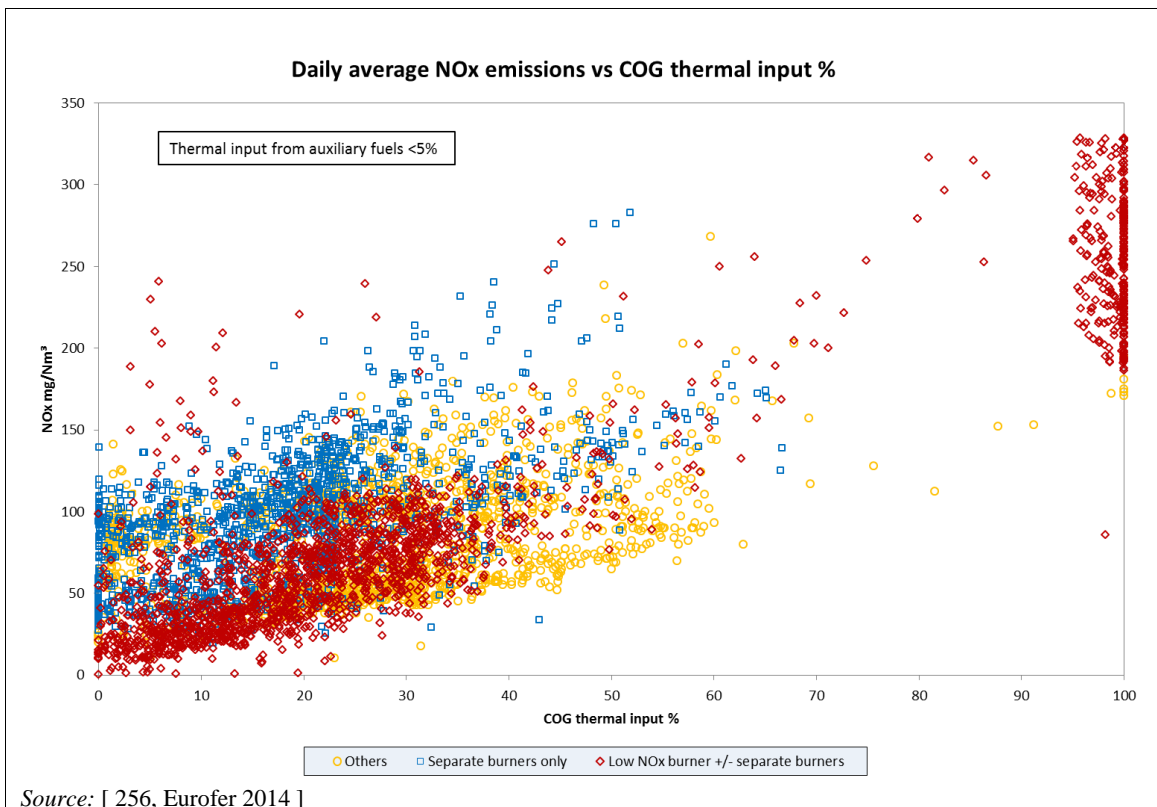

Figure 7.53: Relationship between the NO_x emission and COG thermal input (%) for LCPs utilising iron and steel process gases

Crossing this data set and the data collected in 2012 reported in Figure 7.52, and taking only into consideration those plants fitted with a combination of primary techniques including LNB and/or SCR, e.g. Plants 601-1, 606 or 601-5, which combust yearly average levels of COG of > 32 %, it can be noted that daily emission levels below 160 mg/Nm³ are generally achieved. There are still a few days in the year when the COG participation is very high and/or when the level of H₂ in this COG is very high, and the NO_x emission levels can be as high as 220 mg/Nm³ for those plants.

- Besides the 95th percentile of hourly averages reported in Figure 7.52 for CCGTs, additional daily average data were collected by EUROFER in 2014. Taking only into consideration those plants fitted with DLN, steam injection when using natural gas, and/or SCR, e.g. Plants 001 or 359B, which combust yearly average levels of COG of > 22 %, it can be noted that daily emission levels below 70 mg/Nm³ are generally achieved with much less variation linked to the COG content in this case than in the case of boilers. This is to be expected since most CCGTs use NG for the turbine to ensure consistent operation and the boiler part is fired with process gases. Hence fuel variations are confined to one part of the operation resulting in less variation in the NO_x emission levels.

For plants combusting liquid auxiliary fuels with higher participation, the levels of NO_x emitted when combusted (alone or in combination with iron and steel process gases) are similar to those that would be emitted by plants of the same size combusting only these fuels and operated < 1 500 h/yr for example.

7.3.3.2.2 Specially designed low-NO_x burners in multiple rows per type of fuel or including specific features for multi-fuel firing

Description

The use of low-NO_x burners adapted to the typical fuels combusted and to the characteristics of the combustion chamber enables the compromise combination that reduces NO_x generation the most during combustion.

Technical description

Each boiler (or gas turbine) utilises different amounts of process gas, so the specially designed burners are a compromise design based on the most likely average combination of gases. This results in burner designs that encompass the most recent technology and a design specific to each boiler in question. At the time of retrofitting, additional techniques may also be introduced (cost and space permitting), such as flue-gas recirculation.

This technique can be split into individual burners for each process gas or fuel (including high calorific value fuels) or designed multi-fuel process gas burners. According to the fuel input, separate lances for COG and NG can be used.

Several different systems are used that can be grouped under the heading of low-NO_x burners. These include:

- low-NO_x burners for COG;
- specialised burners for auxiliary fuels with high calorific values;
- individual burners for each process gas;
- multi-fuel process-gas burners;
- multi-fuel process-gas and auxiliary fuel burners.

Since 2000, multi-fuel low-NO_x burners have become available featuring flue-gas recirculation, air staging and flue-gas recirculation, and air-staged and fuel-staged combined burners.

Achieved environmental benefit

Reduction of NO_x emissions. The extent of the reduction depends on the deviation from the design gas range.

Environmental performance and operational data

In a retrofit of a boiler at TKS Duisburg in 2002, low-NO_x burners were installed for the simultaneous injection of COG and NG through separate lances. Prior to the introduction of these lances, the range of NO_x emissions was 80–180 mg/Nm³, and afterwards, levels below 100 mg/Nm³ could be achieved when operating with the design range of process gases. In 2005, a further boiler at TKS Duisburg was retrofitted with low-NO_x burners, again for COG and NG. In this case, a reduction from 80–150 mg/Nm³ to < 100 mg/Nm³ was achieved with the same proviso. The 100 mg/Nm³ can only be achieved and maintained when the thermal input of COG (and NG) is held to the burner design specification; higher emissions result in greater levels of thermal input for the COG.

See also Figure 7.51.

Cross-media effects

The emissions of NO_x and CO are always related and it may not be technically possible to simultaneously achieve low NO_x and low CO emissions using primary techniques alone.

Technical considerations relevant to applicability

Low-NO_x burner technology for NG gas is readily available. There has to be sufficient space for the retrofitting of new low-NO_x burners.

As stated previously, each boiler (or gas turbine) utilises different amounts of process gas, so the new burners have to be a compromise design based on the most likely average combination of gases. This results in a burner design specific to the boiler.

As for CCGTs, typical DLN used in NG CCGTs are not applicable to the combustion of iron and steel process gases and natural gas due to the presence of highly reactive hydrogen. The low-NO_x burners have to be specifically designed and, when operated with natural gas only, they require water or steam addition.

Economics

The composition and range of process gases that are used differ from plant to plant, so low-NO_x burners have to be designed and developed for each application. The economics for fitting or retrofitting low-NO_x burners have to be evaluated in each individual case. Low-NO_x burner systems generally have 20–35 % higher investment costs than normal burner systems. In the case of the new installation of Plant 006V in 2010, with a total capacity of 385 MW_{th}, the investment costs for the flue-gas recirculation, air-staged and fuel-staged combined low-NO_x burner system was EUR 3.6 million. In cases of retrofitting, the investment costs could be significantly higher if, for example, space for the burners is restricted.

Driving force for implementation

Low-NO_x burners can be implemented when a plant is revamped, for example, driven by the requirement to reduce NO_x.

Example plants

Plants 006, 621, 625, 601-1/5, 144-1/2, 624, 625, 395, 596, 358 A/B/C.

Reference literature

No information provided.

7.3.3.3 Techniques to prevent and/or control SO_x emissions

The level of SO_x emissions is strongly related to the sulphur content of the different fuels multi-fired in the combustion plants.

COG is the iron and steel process fuel that contains the most sulphur, but it is generally used in a lower quantity than other fuels in combustion plants. Information on techniques to consider for desulphurising the COG (e.g. wet oxidative processes, absorptive processes with subsequent stripping) are described in the Iron and Steel BREF [279, COM 2013] – Sections 5.1.4.4 and 5.3.12.4].

Iron and steel process gases may be co-fired with the following:

- Natural gas and/or liquid fuels as auxiliary fuels. Natural gas contains very low levels of sulphur and thus no technique is needed to reduce the related SO_x emissions. Liquid fuels may contain significant amounts of sulphur and therefore the general techniques listed in Table 6.9 for liquid-fuel-fired plants are to be considered when the combustion plant is co-firing a significant proportion of such fuel. The main technique to consider though is to use low-sulphur fuels.
- Coal. Generally, the coal proportion varies from 35 % to 100 % of the yearly fuel input. However, this section only deals with coal used as auxiliary fuel, thus in much lower proportions. In such cases, the coal selected does not contribute more sulphur to the input load than the COG.

Environmental performance and operational data

For SO_x emissions from multi-fuel-firing combustion plants burning iron and steel process gases, alone or in combination with other gaseous fuels and/or liquid fuels in boilers, or with natural gas in CCGTs

Boilers

Figure 7.54 shows the SO₂ emissions from well-performing gas-fired boilers combusting iron and steel process gases, sometimes with liquid fuels and/or natural gas as auxiliary fuels. Both BFG and BOF gas are generated with low sulphur content and COG is desulphurised as described in the IS BREF (2012). The limited use of auxiliary fuels enables these plants to operate without end-of-pipe sulphur abatement techniques. Depending on the available process gases coming from the iron- and steelworks, these plants combust a majority of BF gas with a low sulphur content in the fuel diet, or combine desulphurised COG with other fuels, or use natural gas as auxiliary fuel or liquid fuels with low sulphur contents. Monitoring is generally carried out by continuous measurement (57 % of the plants), then by periodic measurements (with between 8 and 52 measurements per year), and in a few cases (16 %) by estimation. Short-term averages reported are for continuous monitoring, with averaging periods from half-hourly to 48-hourly. Short-term peak SO₂ emissions can arise when the COG desulphurising plant is undergoing maintenance or when there is a need to use some auxiliary fuel oils at higher rates.

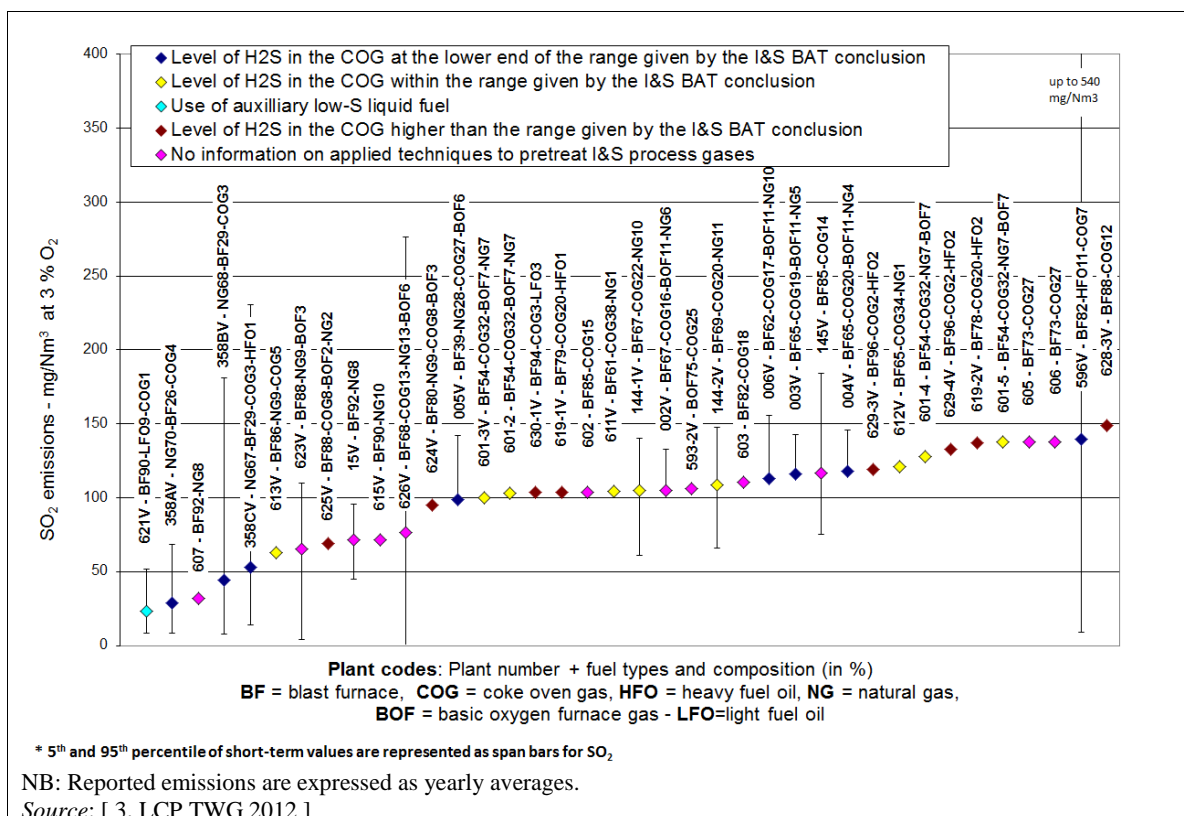

Figure 7.54: SO₂ emissions from well-performing boilers combusting iron and steel process gases

For short-term SO_x emissions, the sector is specific as the composition and quantities of fuels/process gases that are combusted may vary from one day to another and within the same day from hour to hour and, at times, minute to minute. Besides the 95th percentile of hourly averages reported in Figure 7.54, additional daily average data were collected by EUROFER in 2014, as shown in Figure 7.55.

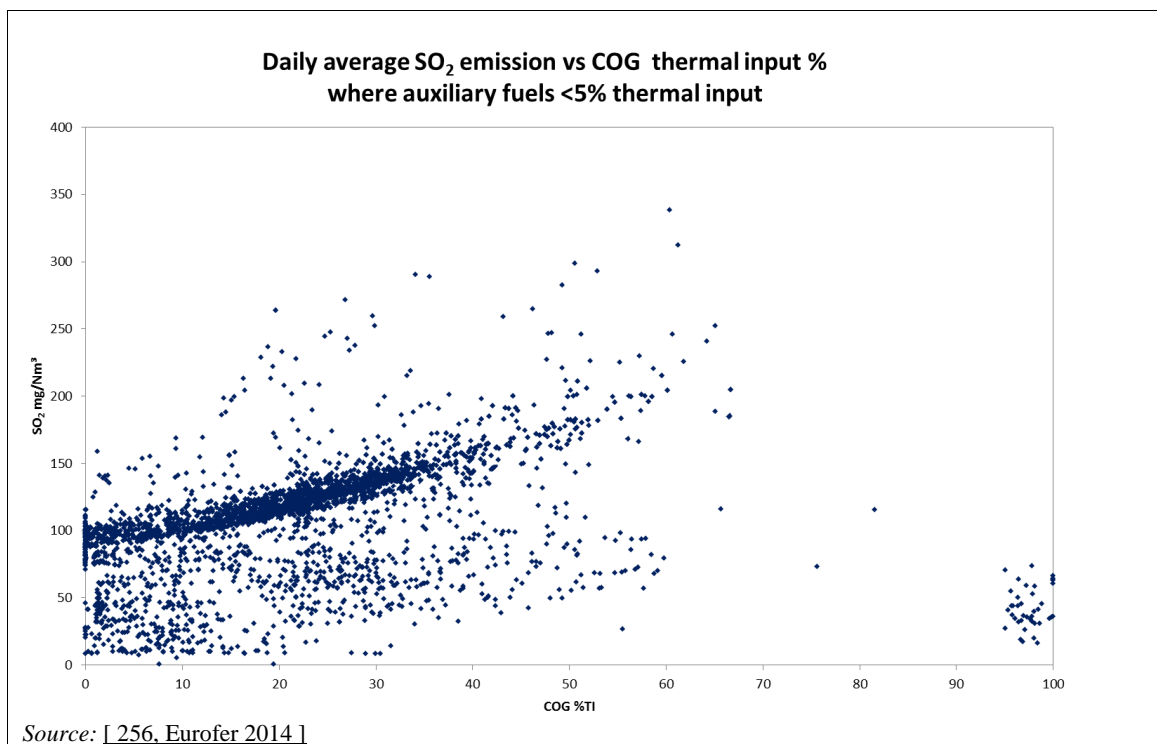

Figure 7.55: Relationship between the daily average SO₂ emission and COG thermal input (%) for boilers using iron and steel process gases (thermal input from auxiliary fuels < 5 %)

Crossing the set of data shown in Figure 7.55, which does not show the type of technique used to control the SO₂ emissions, and the data collected in 2012 reported in Figure 7.54, taking into consideration only those plants operating within the environmental performance levels defined in the IS BREF (e.g. Plants 144-1, 004, 596 or 612, which combust yearly average levels of COG of > 20 %) it can be noted that daily emission levels below 200 mg/Nm³ are generally achieved but there are a few days in the year when the COG participation could be very high and/or when the level of S in this COG may be very high, and when the SO₂ emission levels can be as high as 300 mg/Nm³. The only plant permanently combusting a high share of COG (Plant 395) is fitted with an efficient desulphurisation system to deal with possibly higher SO_x levels, leading to daily SO₂ emission levels usually well below 100 mg/Nm³.

CCGTs

Figure 7.56 shows the SO₂ emissions from well-performing CCGTs firing iron and steel process gases in combination with natural gas. COG desulphurisation and high proportions of natural gas and blast furnace gas are used in the plants reported in this figure. The monitoring is generally performed by continuous measurement, and short-term reported averaging periods are from hourly to 48-hourly.

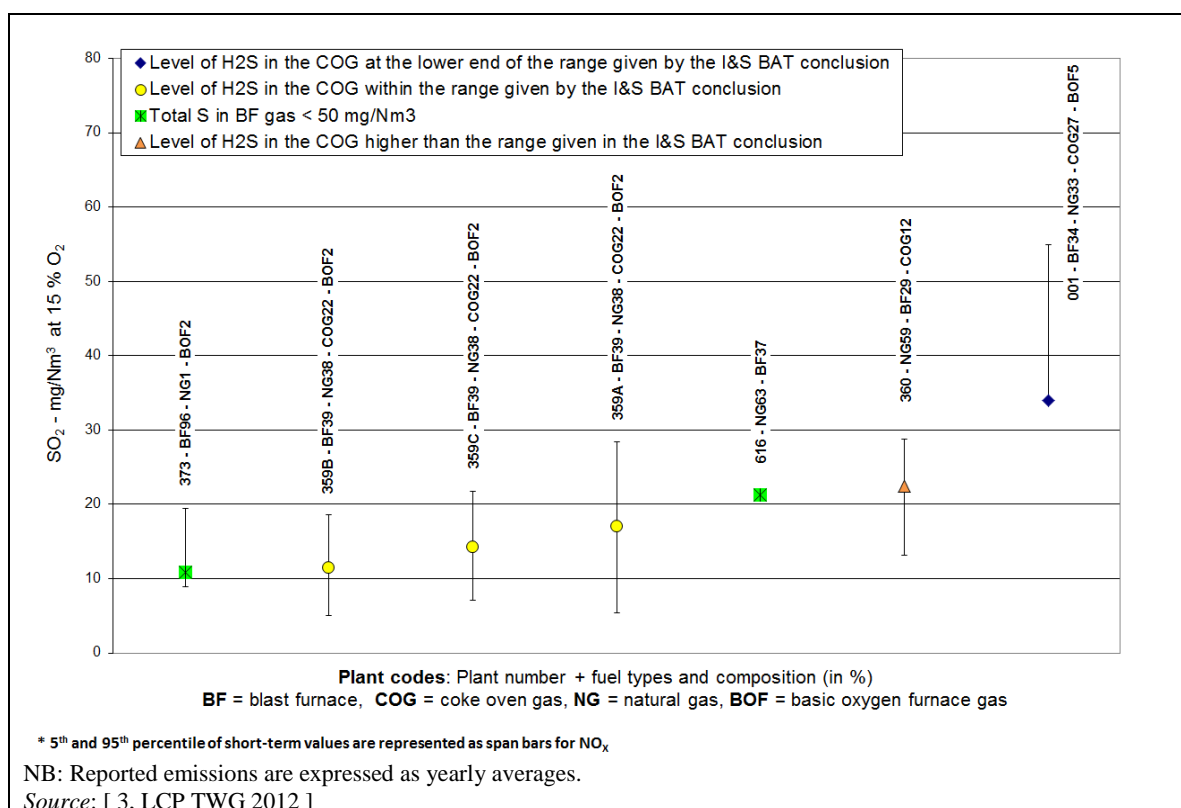

Figure 7.56: SO₂ emissions from well-performing CCGTs combusting iron and steel process gases

Besides the 95th percentile of hourly averages reported in Figure 7.56, additional daily average data were collected by EUROFER in 2014. Crossing the two data sets for these CCGTs reveal that daily emission levels below 70 mg/Nm³ are generally achieved with much less variation linked to the COG content in this case than in the case of boilers.

7.3.3.4 Techniques to prevent and/or control dust emissions

Dust emissions are related to the dust/ash content in the different fuels multi-fired in the combustion plants.

BFG is used in large quantities throughout the iron- and steelworks and is cleaned to < 10 mg dust/Nm³ employing techniques including coarse dust removal and wet scrubbing for the removal of fine dusts and sulphur compounds. In some plants electrostatic precipitators are used. Techniques to consider for pretreating the BF gas are described in the Iron and Steel BREF [279, COM 2013] – Section 6.3.4.

BOF gas is utilised in a much lower quantity than BFG and is dedusted using a variety of techniques including cyclones, venturi scrubbers, and dry and wet electrostatic precipitators. Techniques to consider for dedusting the BOF gas are described in the Iron and Steel BREF [279, COM 2013] – Section 7.3.1, which gives a residual dust content of BOF gas between 10 mg/Nm³ and 50 mg/Nm³.

Gas produced at the coke ovens undergoes considerable cleaning to enable its use throughout the steelworks.

Iron and steel gases may be co-fired with the following:

- Natural gas and/or liquid fuels as auxiliary fuels. Natural gas contains very low levels of ash and thus no technique is needed to reduce the related dust emissions. Liquid fuels may

contain a significant amount of ash and therefore the general techniques listed in Table 6.10 for liquid-fuel-fired plants may also have to be considered when the combustion plant is co-firing a significant proportion of such fuel. The main technique to consider though is to use low-ash fuel oils.

- Coal. Generally, the coal proportion varies from 35 % to 100 % of the yearly fuel input. However, this section only deals with coal used as auxiliary fuel, thus in much lower proportions (< 5 %). This ensures low dust emission. If used in higher proportions, the general techniques listed in Table 5.31 for coal-fired plants are also to be considered.

Environmental performance and operational data

For dust emissions from multi-fuel-firing combustion plants burning iron and steel process gases, alone or in combination with other gaseous fuels and/or liquid fuels in boilers, or with natural gas in CCGTs

Figure 7.57 shows dust emissions from well-performing boilers combusting iron and steel process gases, mainly implementing the pretreatment of BF gas at the iron- and steelworks level and with fuel-dust levels below 10 mg/Nm³. The short-term reported values are from continuous monitoring for averaging periods from hourly to 48-hourly.

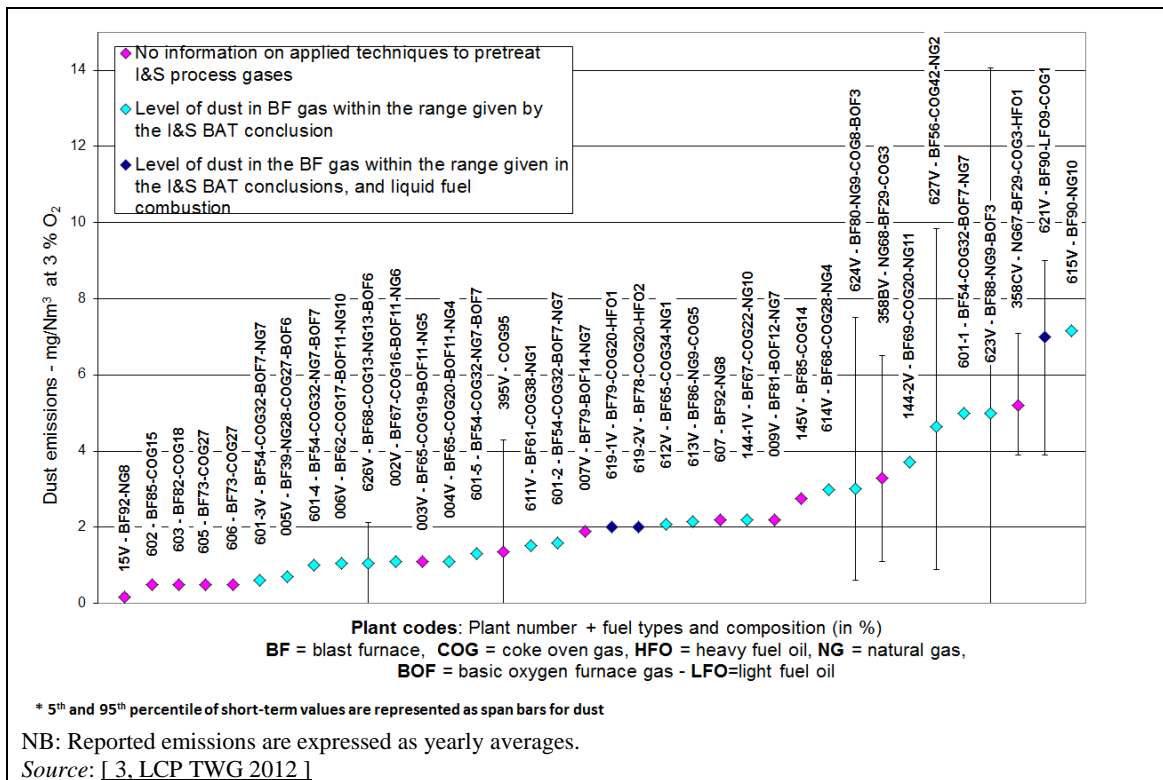

Figure 7.57: Dust emissions from well-performing boilers combusting iron and steel process gases

Figure 7.58 shows dust emissions from CCGTs combusting iron and steel process gases, mainly implementing the pretreatment of BF gas at the iron- and steelworks level.

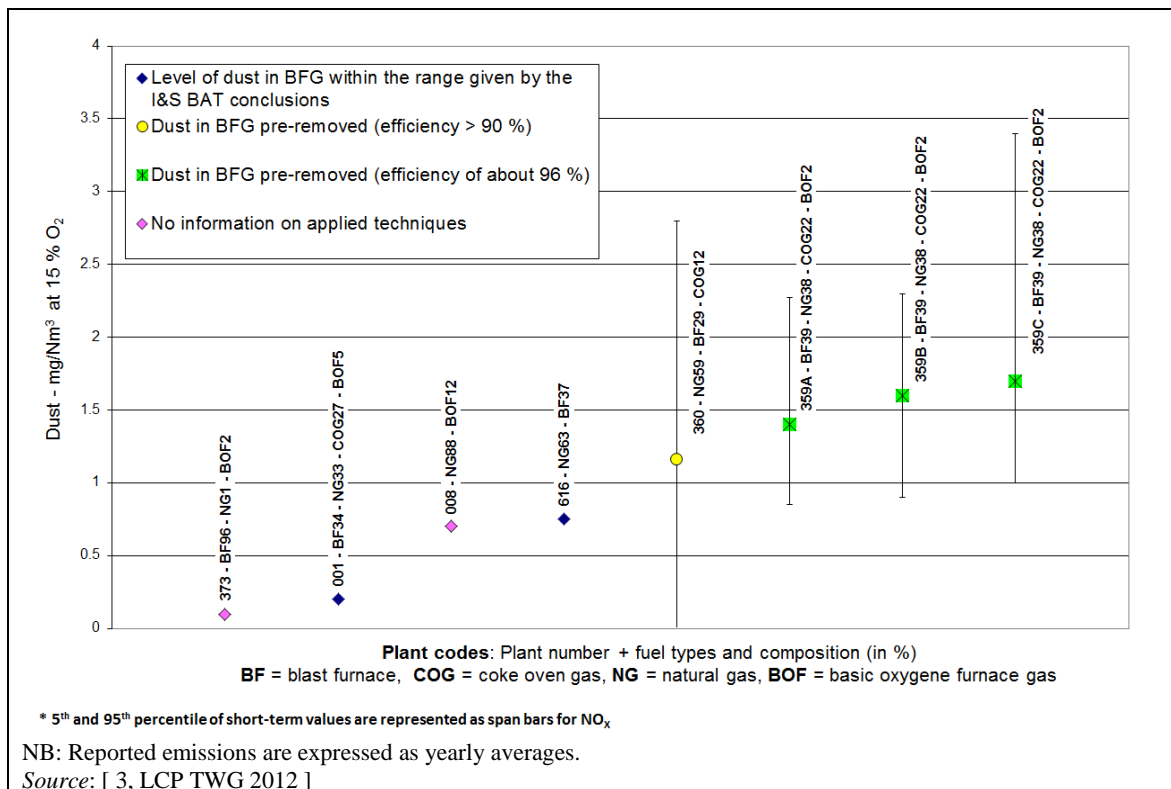

Figure 7.58: Dust emissions from well-performing CCGTs combusting iron and steel process gases

7.4 Combustion of gas on offshore platforms

7.4.1 Applied processes and techniques

7.4.1.1 Offshore combustion installations

Oil and gas production facilities in the UK, Norwegian or Danish offshore sectors in the North Sea, typically use gas turbines for power generation and direct drive compressors. Reciprocating internal combustion engines ('diesels') may also be used as primary back-up for power generation when gas is not available, for emergency power generation and fire pumps, as well as for numerous smaller duties. The majority of these combustion plants of $\geq 50 \text{ MW}_{\text{th}}$, about 270, are primarily gas turbines fuelled by natural gas produced from the field under operation. Associated gas is preferentially exported; combusted in gas turbines/engines; injected into wells for enhanced oil recovery or gas disposal and where that is not possible or has reached its limit, excess gas might then be flared or vented to the air. The crude natural gas varies both in composition and calorific value, from field to field and, over time, even within a field [124, OGP, 2000].



Source: [257, Marathon OIL 2000]

Figure 7.59: North Sea oil platform

Offshore platforms are not connected, in most cases, to the mainland or inter-platform electrical grid. Dual fuel gas turbines are therefore used in the vast majority of cases for power production, ensuring continuous power supply to the platform in the event of a gas plant trip or cessation of production (no gas). Diesel is often the alternate fuel. There are two basic types of industrial gas turbines used in offshore applications: aeroderived gas turbines and heavy-duty gas turbines. The dual fuel (DF) reciprocating engine is typically used in the offshore market. (See Section 2.3.2.3 for more information about this type of engine.)

The aeroderivative type of gas turbine is more adaptable to variable loads than the heavy-duty unit and is, therefore, widely used for gas and oil pumping, as well as for electrical power generation. The gas turbine may contain more than one concentric shaft, to obtain the optimum performance from different stages of gas expansion and air compression.

The heavy-duty gas turbines are used mainly for electricity generation. They are often built as a single-shaft machine, where the compressor, gas turbine and power turbine are all on a single shaft. On start-up, the complete rotor has to be accelerated to a self-sustaining speed, usually by a diesel engine or electric motor. When used for power generation, they can maintain good speed control, even in the event of a loss of electrical load. [306, DTI 2001]

An offshore oil and gas facility, although using some combustion equipment common to onshore applications, is a more complex and potentially hazardous environment than, say, an onshore power station, which results in higher costs due to the following reasons:

- logistics related to bringing people and equipment to the installation;
- limited cabin capacity for additional crew during modification work, which may mean either a prolonged installation period or the need to rent a flotel (floating hotel);
- higher man-hour rates;
- hot work in congested process areas is a safety hazard; thus more of the work will have to be carried out complying with strict rules (which add to the cost) or during complete shutdown (loss of production);
- the more extensive and sophisticated fire protection systems often have to be modified too, in addition to the equipment modifications;
- if modifications require additional space, expensive structural work has to be carried out, if at all possible;
- the value of lost or deferred production is often more significant than for a land-based facility.

In addition, space and weight are at a premium, leading to a much higher equipment density than is common in onshore applications. In addition, any undue complexity is generally avoided offshore, because of the weight, space, and operability factors, including safety factors [306, DTI 2001]. Therefore, more complex systems, such as combined-cycle plants, are applied only in a very few cases, as are systems which require significant chemical usage or supporting equipment offshore, e.g. flue-gas cleaning devices.

7.4.1.2 Control of emissions to air

Consideration of the mechanisms of nitric oxide formation (see also Section 1.3.2.2) shows that the design of combustion equipment to reduce its formation by the thermal route involves limiting the overall temperature and residence time, and minimising the formation of hot spots, by optimising air and fuel mixing.

Improving the thermal efficiency by operating at higher temperatures, however, tends to increase nitric oxide concentrations, although mass releases may be reduced because of increased energy efficiency, but this phenomenon is, however, very plant-specific. Normally the NO_x emissions decrease with load due to an decrease in flame temperature. However, for certain dry low-NO_x systems, the emissions of NO_x can be higher when operating in part load mode. It is also worth noting the impact on CO emissions at low loads - they may rise exponentially in many cases.

Water and steam injections are available for a range of gas turbines. This requires modifying the fuel jets or installing a separate water injection manifold. Water is injected at a preset ratio with the fuel. For example, a 50 MW_{th} plant would require about 3 tonnes of water per hour to achieve a 65 % reduction in NO_x emissions. There is a modest increase in power output but a slight decrease in the turbine efficiency. It is worth noting that the water used for water injection into turbines for NO_x reduction needs to be of a very high quality. All water of this quality needs to be made from seawater or taken offshore by supply vessels. The energy requirement in the former would be significant. In the latter case there would be a requirement to supply throughout the year and this can cause problems during periods of adverse weather. A full-scale pilot project on water injection was due to start in the spring of 2014 on one of the Norwegian platforms. The expected environmental performance for NO_x emissions was about < 50 mg/Nm³ when burning gas fuel and < 84 mg/Nm³ when burning liquid fuel.

Steam injection into the combustion chamber of a gas turbine has the same effect as water injection in cooling the combustor and reducing the thermal oxides of nitrogen. For a 50 MW_{th} plant, about 4 tonnes of steam per hour would be required to achieve a 65 % reduction in NO_x emissions. The Cheng steam injection cycle for simultaneously reducing NO_x and increasing efficiency, which can also be applied to all gaseous fuel turbines with conventional combustion (diffusion flame technology), can be applied to offshore turbines. Conventional steam injection in gas-fired turbines is described in Section 3.2.2.3.10, where 40 % to 60 % NO_x emission reduction can be achieved with no significant increase in CO emission. However, the Cheng steam injection cycle provides solutions which make this NO_x control technique more qualified than conventional steam injection. The Cheng system provides unique mixing of gaseous fuel and steam, so that NO_x can be reduced by up to 95 %. Again, the high-quality water required to produce steam is not usually readily available in an offshore facility. [306, DTI 2001]

More and more turbine manufacturers are developing dry low-NO_x emission (DLE) technology, using gas analyser equipment and software integrated into the fuel and engine management system, for new turbines and for retrofitting equipment. Because of the special constraints on offshore platforms (i.e. space, complexity and weight), water and steam injection is not a very practical solution; dry low-NO_x technology is currently applied to about 23 % (i.e. 41 out of 179) of the gas turbines on Norwegian platforms. DLE turbines are installed more frequently in mechanical drive applications [259, Carstensen and Skorpning 2000]. The use of a low-NO_x technique needs to be considered in relation to weight, space and reliability issues as well as the impact of low loading (including the need for spinning reserve).

Post-combustion techniques, such as SCR, have been applied to gas turbines in several European countries and in parts of Japan and California, in order to meet strict emission standards for nitrogen oxides. SCR is a chemical reduction of nitrogen oxides by a reducing agent, usually ammonia gas. Due to the space and weight of such a system and particularly the health and safety problems encountered during the storage and handling of ammonia, this

technique has not been applied and is not considered particularly viable for offshore combustion plants at present.

There are various techniques for measuring or monitoring emissions from exhaust stacks, of which the Predictive Emissions Monitoring System (PEMS) and CEMS are for continuous monitoring and physical periodic sampling used as an alternative. PEMS is widely used in the US for NO_x monitoring. In the US, the operator of a plant can apply to use PEMS instead of CEMS if the plant can demonstrate that the new PEMS has ‘the same or better precision, reliability, accessibility and timeliness as that provided by the continuous emission monitoring systems’. PEMS is implemented as well on European platforms as an alternative to CEMS.

7.4.2 Current emission and consumption levels

7.4.2.1 Non-conventional gaseous fuels combusted

Offshore gas turbines burn crude natural gas supplied directly by the adjacent oilfield. This gas can have a different composition from that of natural gas normally used for onshore gas turbines. An example composition of natural gas from an oilfield in the North Sea can be seen in Table 7.26 but it should be noted that this gas composition may vary significantly across different facilities and potentially even over the asset's life.

Table 7.26: An example composition of crude natural gas from an oilfield in the North Sea

Component	Mol %	g/mol
Methane	68.69	46.18
CO ₂ ⁽¹⁾	14.65	27.01
Ethane	8.18	10.31
Propane	4.45	8.22
n-Butane	1.19	2.9
Nitrogen	0.84	0.98
H ₂ O	0.7	0.52
i-Butane	0.49	1.3
n-Pentane	0.30	0.92
i-Pentane	0.26	0.78
Hexane	0.089	0.32
Heptane	0.06	0.25
Octane	0.033	0.15
H ₂ S	0.007	0.01
Helium	0.0	0.0

⁽¹⁾ The CO₂ content of crude natural gas varies quite a bit from field to field, but is rarely above 10 %.
Source: [250, Finkeldei 2000]

7.4.2.2 Efficiency of non-conventional gaseous fuels combustion in offshore gas turbines

Open- or simple-cycle configurations are mostly used for offshore facilities, because of space, weight, and operability reasons. Thermal efficiencies of up to about 41 % can be expected from the latest new, large gas turbines. However, for existing gas turbines under normal operating conditions, more typical numbers are 30–35 % thermal efficiency. Higher thermal efficiencies can lead to high combustion temperatures, which may increase NO_x production, thus requiring sophisticated combustion chamber designs to achieve both high thermal efficiencies and low emissions. [306, DTI 2001]

The efficiency of the turbines themselves is only one of the factors of the total energy efficiency of the offshore installation. To make energy production on the platforms more efficient, many factors need to be taken into account, including:

- optimising of the process in order to minimise the energy consumption and the mechanical requirements;
- using variable speed drives for large rotating equipment if loads are variable;
- optimising line sizes to reduce pressure drops, using expanders and hydraulic pumps to utilise pressure drops instead of throttling;
- optimising equipment sizing to avoid recycling and part-load operation;
- optimising and maintaining inlet and exhaust systems in a way that keeps the pressure losses as low as practically possible;
- utilising the gas turbine exhaust heat for platform heating purposes;
- considering the lifetime of field production profiles and hence the energy demand which may vary significantly over the 20- to 40-year lifetime of a typical field; this has a significant impact on the loading and machine selection and hence energy efficiency.

7.4.3 Techniques to consider in the determination of BAT for the combustion of gas on offshore platforms

This section describes techniques (or combinations thereof), and associated monitoring, considered to have the potential for achieving a high level of environmental protection in the activities within the scope of this document. The techniques described include both the technology used and the way in which the installations are designed, built, maintained, operated, and decommissioned.

It covers process-integrated and end-of-pipe techniques. Waste prevention and management, including waste minimisation and recycling procedures, are also considered. Furthermore, techniques for reducing the consumption of raw materials, water, and energy are covered.

Annex III to the Industrial Emissions Directive lists a number of criteria for determining BAT, and the information within this chapter addresses these considerations. As far as possible, the standard structure of Table 3.4 is used to outline the information on each technique, to enable a comparison of techniques and the assessment against the definition of BAT given in the Industrial Emissions Directive.

This section does not necessarily provide an exhaustive list of techniques that could be applied in the sector. Other techniques may exist, or may be developed, which could be considered for the determination of BAT for an individual installation.

In this section, the techniques to be considered have only been fully described when they are specific to the considered combusted fuel or applied combustion process (combustion of fuels on offshore platforms). Indeed, for most of the techniques, general descriptions are already presented in Chapter 3. Therefore, in order to avoid repetition, for those general techniques already described in Chapter 3, only the additional information that is specific to the combustion of fuels on offshore platforms is reported here in synthesis tables.

7.4.3.1 Techniques to improve the environmental performance of combustion plants used on offshore platforms

To reduce the environmental impact of offshore gas turbines, the following techniques considered:

- for new installations, selecting turbines or engines which can achieve both a high thermal efficiency and a low emissions spectrum;
- using dual fuel turbines only where operationally necessary;
- minimising the spinning reserve;
- providing a fuel gas supply from a point in the topside oil and gas process which offers a minimum range of fuel gas combustion parameters, e.g. calorific value;
- providing a fuel gas supply from a point in the topside oil and gas process which offers minimum concentrations of sulphurous compounds, to minimise SO₂ formation, appropriately addressing the safety issue that may be linked to the use of ultra-low-sulphur diesel in Europe due to biofuel (FAME) addition. When using liquid distillate fuels, preference should be given to low-sulphur types, where the safety and operational consequences are well understood and manageable;
- operating multiple generator or compressor sets at load points which minimise pollution;
- optimising the maintenance and refurbishment programmes;
- optimising and maintaining inlet and exhaust systems in a way that keeps the pressure losses as low as possible;
- optimising the process in order to minimise the mechanical power requirements and pollution;
- utilising the gas turbine exhaust heat for platform heating purposes where there is a suitable and consistent heat demand and subject to weight and space constraints.

Modern ‘diesel’ engines are available with high-pressure fuel injection controlled by electronics. Additionally, optimised combustion chambers have been developed. This technology can result in increased fuel economy, reduced NO_x and other gaseous emissions and reduced smoke, particularly during acceleration and start-up.

To reduce the environmental impact of offshore engines, the following techniques are considered:

- For new engines, selecting diesels which achieve both high thermal efficiency and a low emissions spectrum.
- Where process gas is used as fuel, providing a supply from a point in the topside process which will offer minimum emissions of SO₂ for example. For liquid distillate fuels, preference should be given to low-sulphur types, where the safety and operational consequences are well-understood and manageable.
- For larger diesels, considering gas fuelling with a ‘torch oil’ ignition charge.
- Optimising injection timing.
- Operating multiple generator or compressor sets at load points which minimise pollution.
- Optimising maintenance and refurbishment programmes.

7.4.3.2 Techniques to increase energy efficiency

Information on general techniques to increase the energy efficiency of combustion units is given in Section 3.2.3. Table 7.27 gives additional information specific to combustion for offshore installations.

Table 7.27: Techniques to consider in the determination of BAT to increase energy efficiency for offshore installations

Technique	Technical description	Achieved environmental benefits	Environmental performance and operational data	Cross-media effects	Technical considerations relevant to applicability		Economics
					New plants	Existing plants	
Cogeneration of heat and power (CHP)	See Section 3.2.3.2	Increased efficiency	Limited operational experience	NA	Generally applicable if there is a sufficient and consistent process heat demand	Applicability limited. In addition to the heat/steam need, the required space must be available and the additional weight needs to be taken into account	Plant-specific
Power integration of multiple fields or platforms	Use of a central power source to a number of participating platforms located at different gas fields / oilfields	Better use of energy generation equipment and thus lower emissions	Limited operational experience	NA	Applicability depends very much on the specific location of the offshore platforms and the gas field / oilfield, alignment of time schedules regarding planning, start-up and cessation of production as well as the organisation of the different participating installations		Major investment costs
Optimisation of energy-consuming equipment	Control and adapt the energy sources to the equipment needs and/or the equipment design to the work to be carried out	Less energy consumption and thus lower emissions	High operational experience	NA	Generally applicable	Generally applicable	NA
Waste heat recovery	Utilisation of gas turbine/engine exhaust heat for platform heating purposes	Better use of energy generation equipment and thus lower emissions	NA	NA	NA	The applicability may be restricted by the level of heat demand and the combustion plant layout (space)	NA
NB: NA: No relevant specific information available.							

7.4.3.3 Techniques to prevent and/or control NO_x and CO emissions

Information on general techniques for the prevention and control of NO_x, CO and NH₃ emissions is given in Section 3.2. Table 7.28, gives information specific to offshore installations.

Table 7.28: Techniques to consider in the determination of BAT to prevent and / or reduce NO_x and CO emissions for offshore installations

Technique	Technical description	Achieved environmental benefits	Environmental performance and operational data	Cross-media effects	Technical considerations relevant to applicability		Economics
					New plants	Existing plants	
Direct steam injection	See Section 3.2.2.3.10. Space, weight and water treatment requirements need careful consideration	Increased efficiency	Limited operational experience	NA	Generally applicable	Applicability limited. In addition to the heat/steam need, the required space must be available and the additional weight needs to be taken into account	Plant-specific
Direct water injection		Reduction of NO _x	NA	NA			NA
Advanced control system	See Section 3.2.3.8	Reduction of NO _x and CO, and energy efficiency increase	High operational experience	None	Generally applicable	The applicability to old combustion plants may be constrained by the need to retrofit the combustion and/or control command system(s)	NA
PEMS (Predictive Emissions Monitoring System)	System to determine the emissions concentration of a pollutant based on its relationship with a number of characteristic continuously monitored process parameters (e.g. fuel-gas consumption, air/fuel ratio) and fuel or feed quality data (e.g. the sulphur content) of an emission source	Better monitoring. Reduction of NO _x	High operational experience	NA	Generally applicable	Generally applicable	NA
Cheng steam injection cycle	See Section 3.2.3.3	NO _x reduction and efficiency increase	NA	NA	Generally applicable	Applicability limited. In addition to the heat/steam need, the required space must be available and the additional weight needs to be taken into account	NA

Dry low-NO _x burners (DLN)	See Section 3.2.2.3.7	NO _x reduction	The DLN technique is commonly applied to new gas turbines operated offshore	Possible reduced efficiency at part load	Generally applicable within the constraints associated with the fuel quality variations	The applicability may be limited by: the availability of a retrofit package (for low-load operation), the complexity of the platform organisation and space availability; and/or constrained by the fuel quality variations	NA
Lean-burn concept	See Section 3.2.2.3.9	Reduction of NO _x	High operational experience		Generally applicable	Applicable when a retrofit package is available	NA
Selective catalytic reduction (SCR)	See Section 3.2.2.3.11	Reduction of NO _x	NA	Ammonia slip	Not generally applicable due to issues related to health and safety, continuity of supply, ammonia storage, lack of space, and load and weight requirements	Not applicable	Plant-specific
Oxidation catalysts	See Section 3.2.2.7.2	Reduction (conversion) of CO into CO ₂	Limited operational experience for turbines	CO ₂ increase, and waste (catalyst) generation	Generally applicable	Applicability may be limited by lack of space and load requirements	High capex. Low opex. Not generally economically viable for plants operated < 500 h/yr
Combustion optimisation	See Section 3.2.2.7.1	Reduction of NO _x and CO emissions	NA	NA	Generally applicable		NA
NB: NA: No relevant specific information available.							

Environmental performance and operational data for NO_x and CO emissions

Data reported from recently commissioned turbines in Denmark [260, Denmark 2015] on offshore platforms show short-term NO_x emission levels of about 15–50 mg/Nm³ when fitted with the DLN technique. Should the DLN technique not be possible to implement due to poor fuel quality or low-load operation, emissions can be up to 250 mg/Nm³ in the case of new standard burners and up to 350 mg/Nm³ in the case of existing optimised standard annular combustion (SAC) burners. [260, Denmark 2015] [262, Norway 2015]

8 MULTI-FUEL COMBUSTION

8.1 Solid multi-fuel combustion

The implementation of multi-fuel firing has significant operational implications. Particularly when co-milling, biomass fuels must be matched closely with individual plant designs for optimum performance, and most combustion plants that have experience of commercial multi-fuel firing have needed to overcome a number of technical issues. Among those, most important have been the health and safety implications of multi-fuel firing a more reactive fuel than the plant was not originally designed to handle. Where technical issues lead to limitations on plant flexibility or availability, multi-fuel firing can also have an adverse impact on the trading of the electricity or the heat produced by the plant.

The impact that biomass co-firing has on the operation of a coal-fired plant depends on the type of plant involved, especially the configuration of the milling plant if the biomass is to be co-milled, the range of coals with which the biomass is to be co-fired, and the characteristics of the biomass. [1, Eurelectric 2012]

8.1.1 Applied processes and techniques

8.1.1.1 Unloading, storage and handling

The processes and techniques used for unloading, storing and handling different solid fuels combusted in the same combustion plants are the ones used for each individual separate solid fuel, already described in Section 2.8.

Much of the recent and likely future increase in biomass use will be using pelletised fuels, mainly wood. The pelletising process reduces the moisture and converts the biomass into a form which is much easier to transport, store and handle.

Some plants have undergone modifications, which are directly attributable to local conditions and/or requirements, involving changes to the rail unloading and conveyor system and blending equipment, principally to minimise dust emissions and to ensure adequate control over the mix of fuel fired in the boiler.

In the case of multi-fuel firing with petroleum coke (pet coke), coal/pet coke mixes may also be imported to the plant provided that adequate blend composition tests are carried out at (for example) a port. Storage of pet coke can be achieved on the normal coal stock either as 100 % pet coke or as a defined coal/pet coke blend.

8.1.1.2 Fuels characterisation and pretreatment

A basic assessment of any new biomass material proposed for a particular plant is typically carried out through a combination of standard fuel analysis techniques, single mill testing and full unit trials. [1, Eurelectric 2013]

Biomass and coal have fundamentally different properties as fuels. Biomass contains larger quantities of alkali and alkaline earth elements (potassium, sodium, calcium, magnesium), phosphorus and chlorine than coal. As all the constituents of the biomass enter the boiler, several technical concerns arise. Higher fuel chlorine contents can lead to greater high-temperature corrosion in boilers. Accelerated fouling and slagging can occur when fuels containing high levels of potassium are utilised [51, Jensen-Holm et al. 2010].

The moisture content of biomass and coal may also be different depending on specific fuel types. Pelletised biomass fuels usually have a moisture content in the order of 10 % by weight, while some other types of biomass may have much a higher moisture content and may need additional drying.

8.1.1.3 Techniques to introduce the different fuels into the combustion process

8.1.1.3.1 Mixing with the main fuel

The most common approach to biomass multi-fuel firing that has been adopted at coal-fired combustion plants is to pulverise the coal and biomass simultaneously in the existing pulverising mills. This approach has been termed 'co-milling', and it allows the simultaneous size reduction and drying of both the biomass and coal, prior to the two fuels being burnt together in the furnace. To avoid detrimental effects on mill performance, co-milling may be limited to < 10 % of the total fuel input.

Where a co-milling approach is adopted, the biomass and coal may be blended before or after delivery to the combustion plant. The former option is referred to as 'off-site blending', and results in a single fuel stream to the combustion plant, which can be handled in a similar way to coal. The latter option is referred to as 'on-site blending', where two fuels are delivered to the combustion plant and require separate reception and handling facilities up until the point where the two fuel streams are blended into one.

[1, Eurelectric 2013]

Since the particle size distribution is a key figure for correct ignition and combustion one of the most reliable solutions is to mill separately and mix the fuel just before the burner inlet. This solution allows optimised pulverisation of both fuels. Pulverised combustion using separate milling systems is now extensively used for firing a wide range of fuels, from forestry residues to agricultural residues and energy crops. Fuel is generally pelletised off-site and transported to the plant by road, ship or rail. At the plant, the pellets are broken up using dedicated hammer mills or in coal mills which have been re-engineered to accommodate the different grinding characteristics. Boilers have been shown to operate at a whole range of co-firing levels from low levels (replacing one mill set) through to a complete conversion where all coal mills and burners have been replaced or modified.

8.1.1.3.2 Dedicated burners

Biomass – coal firing

'Direct injection' offers an alternative route for supplying co-fired biomass to a coal-fired boiler. This involves the introduction of the biomass into the boiler as a separate stream, through dedicated biomass burners. This provides several advantages over co-milling, the most significant being that the biomass does not affect the flow, milling and classification of the coal, and that the unit load limitations that can occur when co-milling with low calorific value coals or biomass are avoided. However, this type of installation is much more capital-intensive than the limited modifications required for a co-milling approach. Installations for direct injection schemes have ranged from a simple hopper feeding a pneumatic transport line leading directly into the furnace to an elaborate chipping/grinding plant feeding separate biomass burners with a complete burner control system.

The separate handling of biomass also allows co-firing to be carried out in a plant that has strict limits on the volatile content in the coal. Biofuels typically contain around 80 % volatile matter (on a 'dry-ash-free' basis), whereas coal-fired plants are designed to receive coals with dry-ash-free volatile contents of less than 45 % for bituminous coals and 10 % for anthracitic coals. This

separate handling also has the advantage that problems that would occur when materials with bad milling properties are sent through the mill can be effectively bypassed.

[1, Eurelectric 2013]

8.1.1.4 Solid multi-fuel combustion processes

8.1.1.4.1 Co-firing of biomass and fossil fuels

One of the primary reasons behind the development and introduction of co-firing of biomass, for instance together with peat or coal, has been the reduction of SO₂ and CO₂ emissions, as the replacement of the primary fossil fuel reduces the emission of fossil CO₂, whereas the renewable CO₂ originating from the biomass is considered carbon-neutral. Data from the German Emission Trading Authority show that, in 2010, four lignite and five hard-coal-fired power plants carried out co-incineration of woody biomass (chips, pellets, etc.) in Germany using a total of 30 000 tonnes of wood and avoiding around 33 000 tonnes of CO₂ compared to the emissions associated with the use of the main fuel being substituted (the co-firing degree achieved was 1–12 %).

Due to the lower initial ash melting point for biomass, the furnace exit gas temperature needs to be reduced. In case of retrofit, the boiler may be down-rated accordingly.

Biomass in general requires a lower primary air temperature for milling and higher air excess for correct combustion. The result is often, especially in the case of retrofits, that the flue-gas leaving the boiler cannot be cooled down to the same level as for pure coal combustion, which may affect the boiler efficiency and requires the checking of any existing filter for temperature tolerance. These effects can be mitigated for instance by installing a primary air cooler or flue-gas cooler.

In many cases, the amounts of biomass available at a reasonable cost in any one location are too small to make a combustion plant based only on biomass economically feasible. The economics of using these locally available fuels may improve considerably if they can be co-fired with a commercial fuel at an existing combustion plant. However, there are considerable technical and environmental restrictions on fuels that can be co-fired. The multi-fuel firing of biomass has been successfully applied at many Finnish FBC power plants, where the main fuel is peat, coal, or wood residues from the pulp and paper industry.

Due to its characteristics, peat is suitable for multi-fuel firing with wood, and in existing plants can help reduce the corrosion and fouling problems that may occur when burning biomass only. The ability to burn peat also ensures a continuous fuel supply in areas where the availability of wood fuel is insufficient for the fuel demand.

A different approach has to be taken when the local fuel cannot, for technical reasons, be burnt together with the main commercial fuel. In this case, a dedicated combustion plant is constructed for the local fuel with a connection to the larger combustion plant. In Denmark, several separate combustion units for straw combustion have been constructed with a connection to coal- or gas-fired large combustion plants.

The fluidised bed combustion (FBC) process provides advantages in terms of ability to burn a wide variety of different fuels.

Circulating FBC (CFBC) boilers can be designed as multi-fuel boilers, i.e. full capacity can be reached with coal alone, with combined firing, or with biomass alone. In the multi-fuel firing of coal and biomass there are separate, independent fuel feeding systems due to the different kinds of fuel handling. These are also needed to ensure flexible and smooth operation for all possible fuel combinations.

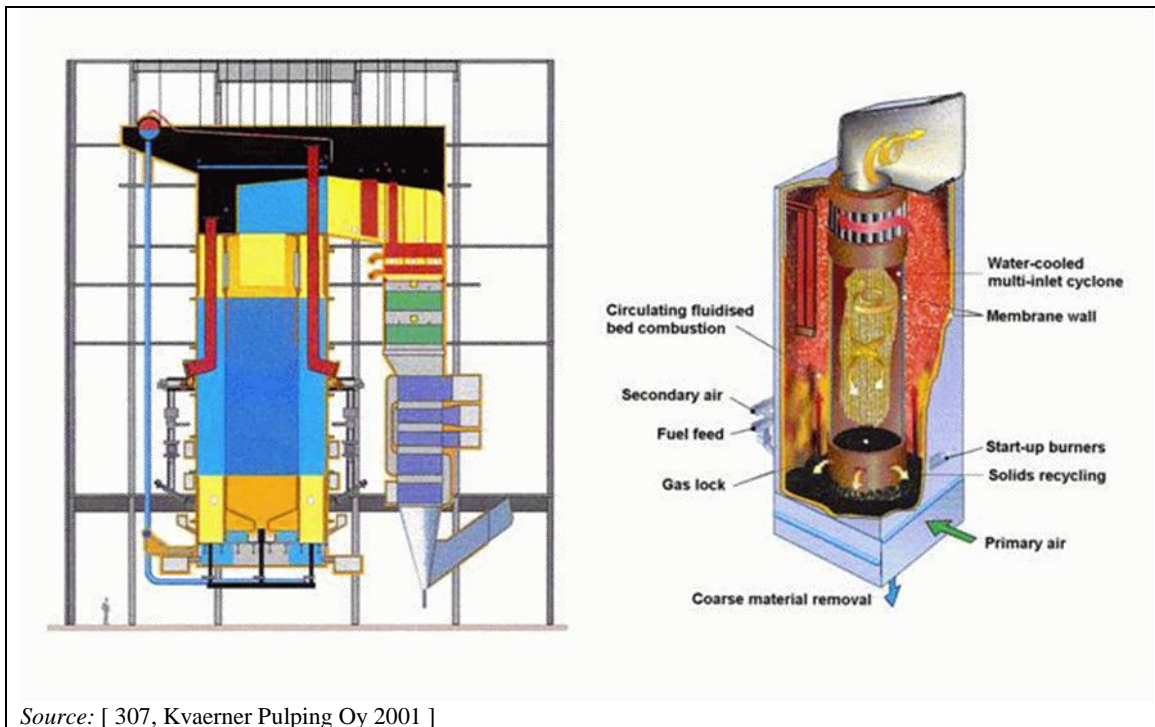

Source: [307, Kvaerner Pulping Oy 2001]

Figure 8.1: Industrial CFB boiler with multi-inlet cyclone applied for multi-fuel firing

In the bubbling fluidised bed (BFB) process, the fluidising velocity is reduced and there is no return of fines by means of a cyclone system. The BFB process is well-suited for burning inhomogeneous biomass and peat fuels including in multi-fuel firing.

Some technical issues observed in early experiences with the multi-fuel firing of biomass and other fuels, mainly coal and lignite, are presented below:

1. Up to 20 % wood was co-fired in a power plant in Denmark. This is a front-fired boiler with natural circulation and a capacity of 125 MW_e. Pulverised wood was burnt in two specially adapted burners. No negative effects were noticed and it was expected that higher co-firing percentages should be possible. NO_x emissions dropped by 35 %. Straw and, to a lesser extent, wood from energy crops (willow) are the most important biomass fuels in Denmark. The high potassium chloride content of straw may cause slagging and corrosion problems.
2. Tests were performed with straw in another Danish power plant (150 MW_e). Up to 25 % co-firing was tested in campaigns varying from 4 weeks to 4 months. The main conclusions were as follows:
 - NO_x and SO₂ emissions decreased, HCl and dust emissions increased
 - A small increase in the corrosion rate of the superheater was noticed. The total duration of the tests was too short to quantify this (it was estimated that there would have been a 50 % increase with a 10 % co-firing proportion).
 - When more than 10 % straw is co-fired, the alkali content of the fly ash exceeds the limit for application in cement. For application in concrete the constraints related to alkali content are less stringent and the straw co-firing degree can be higher than 20 %.
 - DeNO_x catalyst samples exposed to the flue-gas show a quick decrease in activity.
3. Biomass briquettes were co-fired in a lignite-fired power plant in Germany (280 MW_e). There were no problems when firing amounts of up to 10 % by weight.
4. Up to 7 % by weight pressed olive stones were co-combusted in a power plant in Greece consisting of three lignite-fired units with a total installed capacity of 550 MW_{th} for a period of about six months. Special characteristics of the pressed olive stones compared to the raw lignite were: much higher calorific value, remarkably lower moisture and ash content, and

higher content of volatile matter. As for ash composition, a much higher concentration of alkali metal oxides and a lower concentration of silica and alumina compounds resulted in a lower melting point. The experiments showed no changes in steam operating parameters (mass flow, temperature and pressure), slagging, and the content of unburnt fuel in the ash. Due to the significantly lower sulphur content of the pressed olive stones, SO₂ emissions were reduced.

Biomass co-firing in pulverised fuel boilers is economically viable under some countries' renewable energy regimes and the potential scale has facilitated the development of extensive supply chains (for both wood and agricultural residues) and the management of the technical restrictions of fuels that can be used. The co-firing of biomass has been successfully applied at several pulverised fuel plants (in the UK, the Netherlands, Belgium and Denmark) where the main fuel was originally coal. The ultimate outcome of co-firing of biomass with coal may be the complete conversion of a coal boiler to biomass. In this case, in order to handle the different fuel characteristics of biomass compared to coal (e.g. alkalinity), greater technical adaptations are needed than in the case of co-firing limited percentages of biomass.

In the UK, plants have been modified to co-fire biomass with throughput capacities of a million tonnes per year or more. A programme is now in place, following combustion trials, for several plants to fully convert to biomass with planned throughputs of up to 8 million tonnes of wood pellets per year.

More information regarding plants converted from coal to biomass is presented in Section 5.2.

There are particular cases where the multi-fuel combustion of coal and certain types of biomass is closely related to the local availability of specific biomass fuel streams. This is the case, for instance, of three grate-fired boilers between 116 MW_{th} and 128 MW_{th} commissioned in La Réunion and Guadeloupe islands between 1992 and 1998 (Plants 684, 686 and 688 in the 2012 data collection). These plants are erected in the vicinity of sugar plants, from which they buy sugar cane bagasse as fuel and to which they sell steam for industrial use. They combust coal and bagasse in variable proportions (up to 68 % bagasse in 2012) depending on the availability of bagasse and on the production needs (electricity needs on the island and heat needs for industrial uses). Both criteria fluctuate according to the season.

Petroleum coke (pet coke) can also be successfully co-fired with coal at blends of up to 20 % by thermal input. In the UK, two power plants (2 000 MW_{th} and 4 000 MW_{th}) have been using pet coke without appreciable negative impacts since 2004.

8.1.1.5 Control of emissions to air in solid multi-fuel combustion LCPs

Fluidised bed boilers

The low furnace temperatures in the fluidised bed process coupled with staged air feeding result in NO_x emissions typically below 200 mg/Nm³. For further NO_x reduction, an ammonia injection (SNCR) system can be easily installed, which can achieve emission levels down to, or below, 100 mg/Nm³ (dry, 6 % O₂). SO_x emissions may be controlled by limestone injection into the furnace where the conditions for desulphurisation are favourable. The multi-fuel firing of biofuel with coal will further reduce SO_x emissions and limestone consumption. Compared to coal-only combustion, coal-biomass multi-fuel firing achieves lower primary NO_x and SO_x emissions and reduces specific CO₂ emissions in proportion to the biomass fuel input.

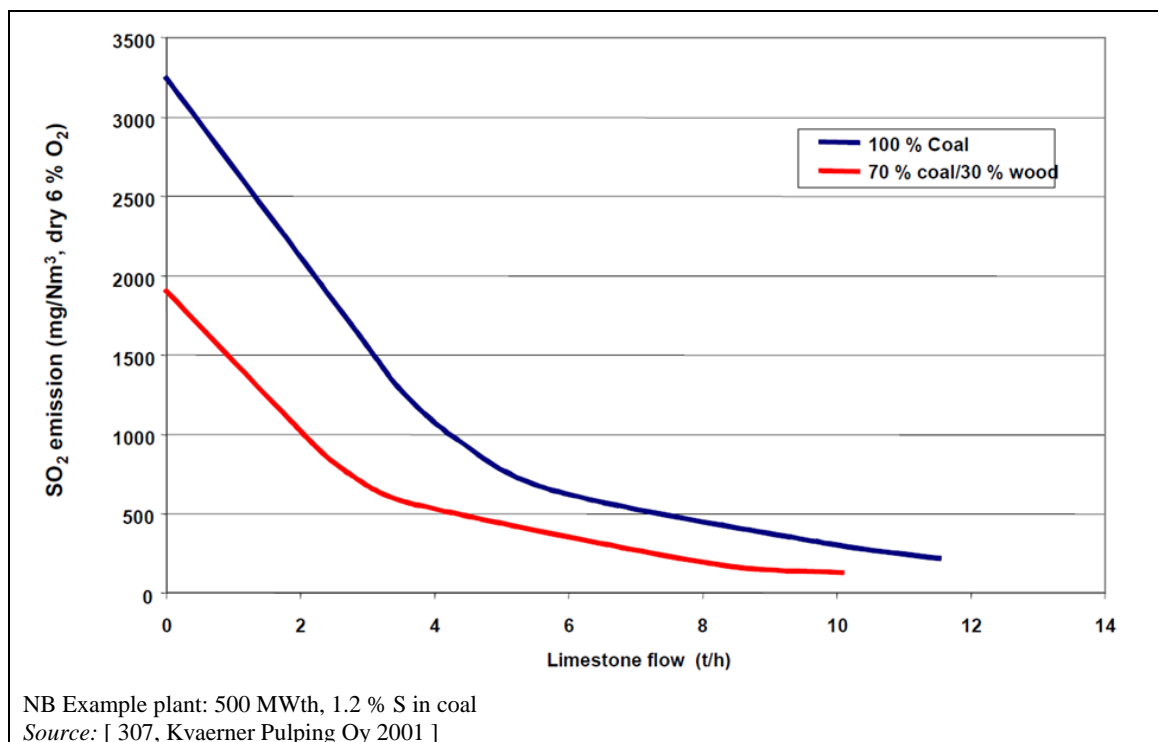

Figure 8.2: The effect of biomass multi-fuel firing on SO₂ emissions

Pulverised-fuel boilers

The biomass is mixed with the coal/lignite in the storage area, which may produce fairly high emissions of dust, or is introduced separately into the combustion chamber.

Typical consequences of multi-fuel firing biomass with coal, in the case of PC boilers configured as described above, include the following:

- NO₂ concentrations in the raw flue-gas decrease slightly.
- The concentration of dust in the flue-gas after the ESP increases, probably due to the higher concentration of fine particles; the separation of dust in the FGD ensures low concentrations in the cleaned flue-gas.
- The sulphur contents of biomass fuels are, in general, about ten to a hundred times lower than in coal, resulting in a reduction of SO_x concentrations. HCl emissions may instead increase in multi-fuel firing due to the high content of chlorine in certain types of biomass, but they usually remain low if the biomass participation in the fuel mix is limited. The increased halide levels might, in the long run, also cause corrosion problems in the FGD system.

The operation of SCR systems is affected by the multi-fuel firing of biomass and coal in boilers designed for coal. The SCR catalysts are susceptible to poisoning due to condensation of volatile inorganic species on the catalyst surface. The formation of sulphate- or phosphate-based deposits on the catalyst surface or the reaction with the catalyst's active species can significantly reduce catalyst activity, resulting in a shorter lifetime.

Multi-fuel firing biomass and coal or injecting coal fly ash has been proven to be an effective measure for limiting the deactivation of the SCR catalyst since the gaseous potassium and phosphorus species released from the biomass are readily reacted with the coal fly ash, forming much more stable compounds and larger ash particles, which may require filtering out before the flue-gas enters the SCR.

Deactivation of high-dust SCR catalyst is one of the critical issues of straw multi-fuel firing.

Due to the low combustion temperature, grate firing of biomass may not evaporate alkali metals and release the salts as aerosols to the same degree as pulverised-fuel or CFB firing, and thus SCR catalyst deactivation could be a lesser problem with grate firing than with other boiler types.

Reference literature

[51, Jensen-Holm et al. 2010], [308, Schmidt et al. 1999], [309, Kindler et al. 2000]

8.1.2 Current emission and consumption levels

8.1.2.1 Degree of solid multi-fuel firing in LCPs

Many examples of combustion plants of different types and sizes can be found across the EU, demonstrating the multi-fuel firing of biomass with coal and lignite to a very broad range of degrees, even exceeding 50 %. The achieved performance and emission levels of these plants are reported in Section 5.1.3 for plants where the fuel that delivers the majority of thermal input is coal or lignite, and in Section 5.2.3 when the thermal input delivered by biomass fuel surpasses the thermal input of the coal or lignite, or when the main fuel is peat.

The following list of example plants provides an overview of the range of plant types and sizes, and of the multi-fuel firing degrees observed:

- Plant 381V is a 180 MW_{th} DBB combusting 5 % woody and herbaceous biomass together with coal;
- Plant 390-6V is a 611 MW_{th} CFB boiler combusting 7 % woody and herbaceous biomass together with lignite;
- Plant 479V is a 1 600 MW_{th} CFB boiler combusting 7 % woody biomass together with coal;
- Plant 385V is a 396 MW_{th} CFB boiler combusting 11 % herbaceous biomass together with coal;
- Plant 414VC is a 78 MW_{th} DBB combusting 12 % woody biomass together with lignite;
- Plant 693 is a 674 MW_{th} CFB boiler combusting 14 % woody biomass together with coal;
- Plant 367V is a 1384 MW_{th} WBB boiler combusting 15 % woody biomass together with coal;
- Plant 22_1V is a 157 MW_{th} CFB boiler combusting 40 % woody biomass together with lignite;
- Plant 379V is a 186 MW_{th} DBB combusting 43 % woody biomass together with coal;
- Plant 688 is a 124 MW_{th} grate-fired boiler combusting 46 % herbaceous biomass together with coal;
- Plant 684 is a 116 MW_{th} grate-fired boiler combusting 64 % sugar cane bagasse together with 36 % coal;
- Plants 489-1V and 489-2V are 92 MW_{th} CFB boilers combusting 94 % woody biomass and forest residues together with 5 % coal.

8.1.2.2 Effects of solid multi-fuel combustion on plant performance and efficiency

Typical consequences of multi-fuel firing biomass with coal include the temperature of the flue-gas rising under multi-fuel firing conditions by 5–10 °C and the share of combustible matter, which is related to the particle size distribution in the ash, nearly doubling. However, the ash content is a tenth of coal's. Although these effects may lead to a reduction of the boiler efficiency, studies performed at several combustion plant sites have reported negligible impacts on the performance of the boiler when co-firing biomass material at up to 5–10 % on a thermal basis.

Multi-fuel firing petroleum coke requires no adjustments, from a coal-only mode of operation, in the boiler or in the operational parameters of the plant. However, the increased sulphur content in pet coke may require either preferential blending with low-sulphur coals or an increased performance of the associated flue-gas desulphurisation unit. Overall, monitoring data have shown that the environmental impact of a plant burning a coal-pet coke blend is similar to that of the same plant burning only coal. [170, DEBCO 2013]

8.1.2.3 Effects of solid multi-fuel combustion on emissions to air

As mentioned in Section 8.1.1.5, the multi-fuel firing of biomass with coal may be associated, compared with pure coal firing, with slight reductions in SO_x and NO_x emissions, and with increased emissions of HCl. However, by limiting the degree of multi-fuel combustion and/or using properly implemented techniques, well-performing plants achieve similar emission levels as comparable plants that do not co-fire biomass.

Figure 5.32 shows SO₂ emissions from well-performing coal- and/or lignite-fired combustion plants of more than 300 MW_{th}. Among the plants shown, Plants 17V, 366V and 367V co-fire biomass to degrees between 5 % and 30 %. All these plants are fitted with wet FGD and achieve comparable SO₂ emission levels to other similar plants that do not co-fire biomass.

Figure 5.34 shows HCl emissions from well-performing coal- and/or lignite-fired plants of > 100 MW_{th}. Among the plants shown, Plants 17V, 367V, 390-5V, 390-6V, 224V and 479V co-fire biomass to degrees between 5 % and 17 %. All these plants are fitted either with wet FGD or with boiler sorbent injection and achieve comparable HCl emission levels as other similar plants that do not co-fire biomass.

Figure 5.37 and Figure 5.38 show NO_x emissions from well-performing coal and lignite boilers of more than 300 MW_{th}. Among the plants shown, only two plants (Plant 367V and 224V) co-fire biomass.

8.1.2.4 Effects of solid multi-fuel combustion on the quality of combustion residues

The quality of residues (fly ash, boiler ash, gypsum sludge) is typically only slightly influenced in the case of multi-fuel firing. The disposal of these residues together in an opencast mine as stabilised material is also possible for co-combustion.

The compositions of pulverised fuel ash, furnace bottom ash and gypsum from a unit co-firing up to 20 % petroleum coke generally remain within the specifications for onward sale.

The quality of residues is affected by the ash content of the co-combusted fuel. The EN standards on fly ash for concrete cover fly ash with up to 40 % by weight (50 % in the case of green wood) co-combustion material. [308, Schmidt et al. 1999], [309, Kindler et al. 2000]

8.1.3 Techniques to consider in the determination of BAT in solid multi-fuel combustion

Plants multi-fuel firing coal, lignite, biomass and/or peat apply the techniques that are presented in Chapter 3 and described as techniques to consider in the determination of BAT for the combustion of coal and/or lignite in Section 5.1.3 and for the combustion of biomass and/or peat in Section 5.2.3. The performances of well-performing plants multi-fuel firing solid fuels are reported in charts and tables in those sections and fall within the ranges observed for well-performing plants combusting coal and/or lignite and for well-performing plants combusting biomass and/or peat. No further conclusions are drawn beyond those related to Section 5.1.3 and to Section 5.2.3.

The techniques referenced above do not necessarily provide an exhaustive list of techniques that could be applied in the sector. Other techniques may exist, or may be developed, which could be considered for the determination of BAT for an individual installation.

8.2 Combustion of liquid and gaseous process fuels from the chemical industry

This section covers combustion plants burning liquid and gaseous process fuels from the chemical industry. While a general description of the combustion of liquid or gaseous fuel in boilers is given in Chapters 0 and 7, this section also deals with the specific characteristics of the utility boilers typically in use in the chemical industry. [3, LCP TWG 2012] [52, CEFIC 2012]

8.2.1 Applied processes and techniques

The residues of (petro-)chemical processes are used as gaseous and/or liquid fuels (process fuels) burnt in boilers, often simultaneously, to produce utility steam and/or, in some cases, electricity as a useful alternative to flaring in the atmosphere or incineration. The residues of chemical plants have variable compositions and in some cases their composition may not be known.

The existing large combustion plants located in or near chemical installations and combusting process fuels have a typical thermal input within the range 100–300 MW_{th}. Steam is produced by utility boilers operating at variable loads throughout the year to support the production process in all situations that may occur during the industrial operations. The operational characteristics of these plants are key for the chemical installation production, as well as for safe operation.

The design and the operation of combustion plants in the chemical industry may have some differences from the power generation sector. In addition to the fuel, the main characteristic to be taken into account is the load mode. Figure 8.3 shows two combustion plants integrated within a chemical installation.



Source: [52, CEFIC 2012]

Figure 8.3: Utility boilers in chemical installations

8.2.1.1 Operating conditions

Combustion plants in the industry operate at continuous or variable load to support an industrial process and are designed to supply power and/or steam to the industrial installation during all situations in which the installation might operate, such as process shutdown, start-up, cleaning and soot blowing, tests or disturbances. Consequently, the operating load may be different from the nominal load of the combustion unit.

Boilers in the chemical industry have the following operational specificities, which may affect the pollutant concentrations in the raw flue-gas:

- a. The load is not constant over the whole year and the boiler often operates near the nominal load only for a short period of time, potentially affecting the pollutant concentration levels in the raw flue-gas.
- b. The boiler may burn different fuels, separately or in multi-fuel combustion mode, potentially affecting the raw concentration levels.
- c. The boiler may burn specific process fuels whose compositions are not constant over the year and which can consequently influence the raw concentration levels.

Consequently, the difference between yearly average and peak emissions may be larger than for other boilers combusting fuel with a constant composition and running close to their nominal load for most of the time.

8.2.1.2 Control of NO_x, NH₃ and CO

Two important parameters to take into account when evaluating the techniques to reduce NO_x emissions from the boilers burning process fuels in chemical installations are the following:

- the hydrogen (H₂) content (up to 75 %) in the gaseous fuel, which may favour NO_x formation;
- the nitrogen content in the gaseous or liquid fuel (up to 26 %), which has a significant influence on NO_x formation.

As the process fuels' composition depends on the process and as the utility boilers in chemical installations are very often fuel-flexible, fuel choice and process control are the most commonly applied techniques to control NO_x emissions.

Utility boilers are often not designed as stand-alone combustion units but are built as part of the chemical installation; therefore, space for the implementation of additional facilities in existing installations could be restricted.

Other implemented options are SNCR and SCR. In both cases there are logistical requirements when retrofitting an existing plant, and in the case of SCR considerable space needs to be available too. Moreover, in the chemical industry, utility boilers may be installed near chemical units or reactors that in the presence of ammonia could potentially generate explosive atmospheres and trigger the definition of hazardous zones. Adding the equipment for these techniques may therefore require special provisions.

8.2.1.3 Control of other pollutants

SO_x and dust emissions are usually not major concerns when running the utility boilers in chemical installations on gaseous process fuels, therefore control techniques have not been widely applied for pollutants other than NO_x. However, when utility boilers run on liquid process fuels, several pollutants could be generated depending on the fuel composition. In

existing plants there may be not enough space to install flue-gas treatment systems, such as wet FGD.

The combustion plants referenced in [3, LCP TWG 2012] have in many cases been built before the year 1980, with few exceptions such as a few plants built recently in Germany running on H₂-rich gaseous process fuel.

8.2.2 Current emission and consumption levels

8.2.2.1 Consumption of gaseous and liquid process fuels from the chemical industry

Typically, a utility boiler may burn different gaseous and liquid process fuels separately or in co-firing mode, also with other fuels such as natural gas or heavy fuel oil, which may also be used as back-up fuels when the process fuels are lacking.

The most important properties of process fuels are as follows:

- Variable composition, leading to a broad range of untreated flue-gas concentration levels (e.g. of NO_x) over the year. The NO_x concentration in the raw flue-gas may vary at least within a factor two, sometimes for short periods.
- High hydrogen (H₂) content in the process fuel, which may significantly increase the adiabatic flame temperature and therefore may increase NO_x concentration levels in the raw flue-gas. H₂ content may vary in the range of up to 75 vol-%. Furthermore, process fuels from the petrochemical industry may contain other light organic species (e.g. of the ethane or propane series) that may influence the emissions (raw NO_x concentrations when burning gaseous process fuel may vary within a factor two compared with natural gas).
- High nitrogen (N) content in the liquid process fuel, which may significantly increase the fuel NO_x. The N content may reach a value as high as 26 wt-%, depending on the process. Therefore, the NO_x concentration in the raw flue-gas when burning liquid process fuel may vary within a factor three in comparison with heavy fuel oil, or even more in the case of process fuels with extremely high N content such as nitrile-rich residues.
- Other pollutants in the liquid process fuel (e.g. the sulphur and ash content could be high), which may generate pollutants in the raw flue-gas (e.g. SO_x, dust).

8.2.2.1.1 Energy efficiency

Burning the process fuels from the chemical industry in combustion plants allows for recovery of the internal energy of these fuels, while avoiding the flaring or incineration of such process fuels. The operating total fuel utilisation range observed in boilers combusting such process fuels is 14–92 %, depending on the level of heat recovery; the operating electrical efficiency range is 10–18 % (yearly average, LHV basis).

[3, LCP TWG 2012].

These ranges mostly reflect the performances of utility boilers whose main purpose is the generation of steam and that are operated under variable load conditions. Additionally, the ranges also include older plants commissioned in the 1960s. In general terms, considering the combustion characteristics and high calorific values of gaseous and liquid process fuels of the chemical industry, it can be expected that recent well-performing plants achieve energy efficiency levels in a similar range to those of plants combusting commercial gaseous and liquid fuels operated under similar conditions.

8.2.2.2 Emissions

Table 8.1 presents the range of emissions to air from process fuel-fired combustion plants linked with chemical installations. The data represent specific example plants from [3, LCP TWG 2012]; given the variability of process fuels, these data do not necessarily cover the full emission ranges observed in existing plants. Due to limitations in the number of monitored pollutants reported by several of the plants comprised in the ranges shown in Table 8.1, in certain cases the ranges reported are associated with only a restricted number of plants. This is the case in particular for emissions of HCl and HF, of metals, and of dioxins and furans. In general, the available monitoring data for those emissions are within the range of emissions reported for other types of plants, such as the plants co-incinerating waste described in Chapter 9, which also combust fuels with variable contents of polluting substances. Emissions of hydrogen chloride and of dioxins and furans are only relevant for the combustion of process fuels that originate from chlorine-containing streams.

Table 8.1: Ranges of reported emissions to air from boilers firing process fuels from the chemical industry

Rated thermal input	Typical control techniques	Emissions to air										
		Dust	SO _x	NO _x	CO	NH ₃	HF	HCl	TVOC	Hg	Sb+As+P b+Cr+Co +Cu+Mn +Ni+V	Cd+Pb
MW _{th}		mg/Nm ³										
85–350	LNB/OPT/ SNCR/ SCR	< 1–36	< 1–1 400	70–450	0.2–18	0.3–4	0.4	0.1–21	1–13	0.0005–0.01	0.04–0.2	0.0012–0.06
NB: LNB: Low-NO _x burners. OPT: Other Primary Techniques to reduce NO _x . SCR: Selective catalytic reduction of NO _x . SNCR: Selective non-catalytic reduction of NO _x . Data represented are yearly averages of short-term values (dust, SO _x , NO _x , CO) or averages over one year of short-term sample values (remaining pollutants), without subtraction of uncertainty, and for dry flue-gas and 3 % reference oxygen level. Source: [52, CEFIC 2012]												

8.2.2.2.1 NO_x emissions variability

The hourly and daily average NO_x concentration levels may show variations, with respect to the yearly average level, as a function of the load and of the type of fuels used.

During a one-year period, a utility boiler is commonly operated in the following modes:

- Usual mode when the boiler is burning gaseous process fuel.
- Usual mode when the boiler is burning gaseous and liquid process fuels in a co-firing mode.
- Usual mode when the boiler is burning liquid process fuel.
- Exceptional mode when the boiler is burning liquid process fuel near the nominal load.
- Exceptional mode when the boiler is burning gaseous process fuel near the nominal load.

Figure 8.4 illustrates the abovementioned typical cases of operation of a utility boiler where daily average NO_x emissions throughout the year are shown for a boiler implementing only primary measures. Figure 8.4 does not report real measured data but shows that NO_x emissions are subject to variations, which may be substantial, depending on several parameters.

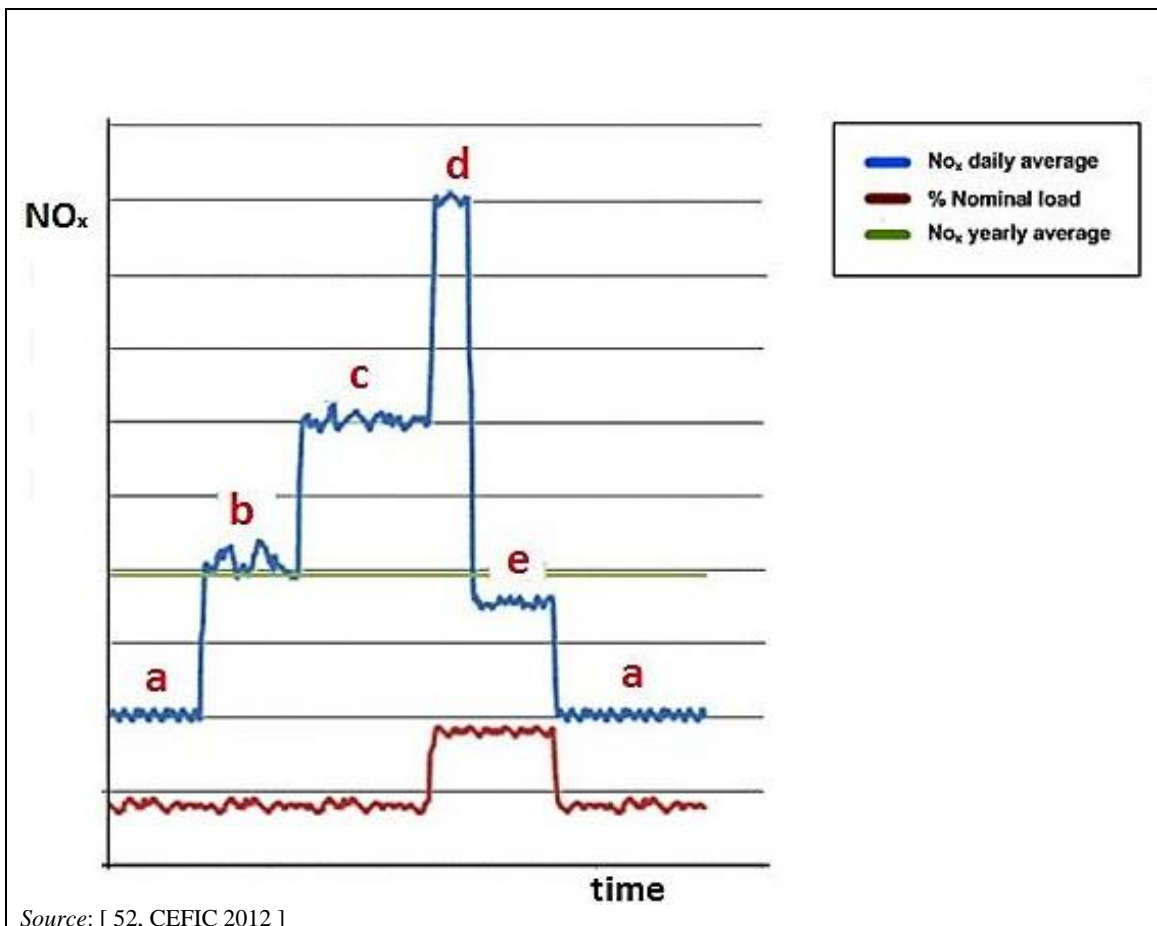

Figure 8.4: NO_x emissions pattern as a function of the daily operation of a utility boiler not fitted with end-of-pipe measures (values are not taken from real installations)

Taking into account the characteristics of the process fuels and utility boilers, Figure 8.5 shows a parametric graph giving a summary of the achieved NO_x emissions at full load (nominal) for existing installations implementing only primary measures separately or in combination, and burning:

- liquid process fuel (= process fuel oil (PFO)) with a high N content (left side of the horizontal axis);
- gaseous process fuel (= process fuel gas (PFG)) with a typical composition (H_2 + other species) in a normal petrochemical process operation (right side of the horizontal axis);
- gaseous process fuel and liquid process fuel (= process fuel gas and process fuel oil (PFG + PFO)), simultaneously in several ratios.

Figure 8.5 is based on measurements of NO_x emissions achieved at nominal load with the implementation of primary techniques in retrofitted utility boilers in the chemical industry. Figure 8.5 also illustrates the following effects:

- The NO_x emissions do not follow a linear evolution for different mixes of PFG and PFO, but clearly indicate a peak for a 33 % share of process fuel gas in the total fuel input in MW_{th} . This particular effect, well known by the manufacturers of low- NO_x burners (LNBs), is due to the fuel gas igniting faster than the fuel oil and then communicating its adiabatic heat to the fuel oil. The oil ignites at a later stage, causing more NO_x at a higher oxidation level. This shows why the combination of the two different flames can increase the NO_x emissions and why a linear extrapolation may not be applied.
- The NO_x emissions with fuel oil are very dependent on the level of nitrogen content in the fuel oil: higher nitrogen content leads to a higher 'peak effect'. The NO_x concentration in the raw flue-gas increases by 70–80 mg/Nm^3 per 0.1 % of nitrogen content at 3 % O_2 .
- Retrofitting the boiler in order to allow fuel flexibility gives new opportunities to control NO_x emissions by operational adjustments. Therefore, a burner revamp that allows for fuel flexibility may also be part of the NO_x reduction performance, and the retrofitting works may also include new fuel skids.

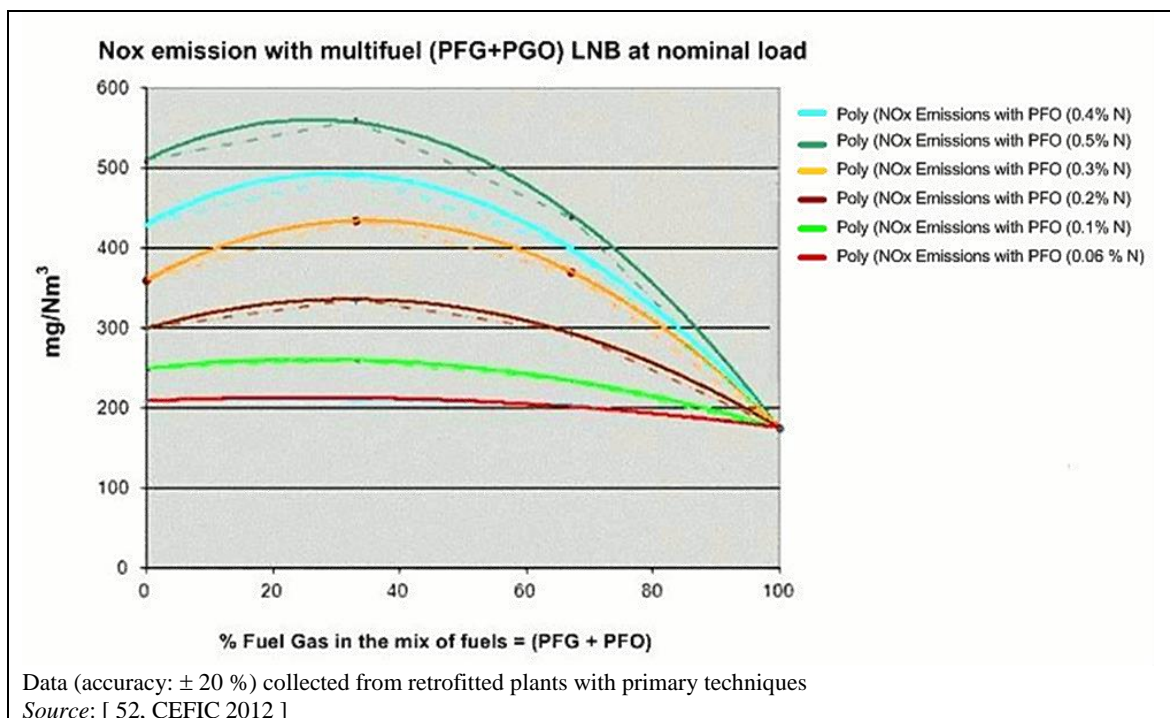

Figure 8.5: NO_x concentration pattern in raw flue-gas as a function of the fuel blend at nominal load

8.2.3 Techniques to consider in the determination of BAT for the combustion of process fuels from the chemical industry

This section describes techniques (or combinations thereof), and associated monitoring, considered to have the potential for achieving a high level of environmental protection in the activities within the scope of this document. The techniques described include both the technology used and the way in which the installations are designed, built, maintained, operated, and decommissioned.

It covers process-integrated techniques and end-of-pipe techniques. Waste prevention and management, including waste minimisation and recycling procedures, are also considered. Furthermore, techniques for reducing the consumption of raw materials, water, and energy are covered.

Annex III to the Industrial Emissions Directive lists a number of criteria for determining BAT, and the information within this chapter addresses these considerations. As far as possible, the standard structure of Table 3.4 is used to outline the information on each technique, to enable a comparison of techniques and the assessment against the definition of BAT given in the Industrial Emissions Directive.

This section does not necessarily provide an exhaustive list of techniques that could be applied in the sector. Other techniques may exist, or may be developed, which could be considered for the determination of BAT for an individual installation.

In this section, the techniques to be considered have only been fully described when they are specific to the considered combusted fuel or applied combustion process (combustion of process fuels from the chemical industry). Indeed, for most of the techniques, general descriptions are already presented in Chapter 3. Therefore, in order to avoid repetition, for those general techniques already described in Chapter 3, only the additional information that is specific to the combustion of process fuels from the chemical industry is reported here in synthesis tables.

8.2.3.1 Techniques to prevent and/or control NO_x, CO and NH₃ emissions

Information on general techniques, including information on complete combustion, for the prevention and control of NO_x, CO and NH₃ emissions are given in Section 3.2.2.3. Table 8.2 gives information specific to process fuel firing, e.g. on applicability, environmental performance and example plants. Finally, Figure 8.9 shows the retrofit of the OFA primary technique in a boiler within a chemical installation.

Table 8.2: Techniques for the prevention and control of NO_x emissions

Technique	Technical description	Achieved environmental benefits	Environmental performance and operational data	Cross-media effects	Technical considerations relevant to applicability		Economics	Example plants
					New plants	Existing plants		
Primary techniques								
Advanced control system	Use of computer-based automated system to control combustion efficiency and support the reduction of emissions, also by using high-performance monitoring	Reduction of NO _x and CO emissions	NA	Improvement of thermal efficiency	Generally applicable	Some of the boilers in the chemical industry date back to the 1960s. Old combustion plants may also need to retrofit the combustion and/or control command systems	NA	NA
Fuel choice	Use of fuels with a low chemical nitrogen content (chemical NO _x)	Reduction of NO _x emissions	NA	NA	At chemical installations, more than the availability of alternative fuels, the most important constraint to fuel choice may be the availability of alternative routes (other than combustion) for the process fuel		NA	NA
Fuel staging (reburning)	See Section 3.2.2.3.6. Fuel staging when using liquid fuel mixtures may require a specific burner design	Reduction of NO _x and CO emissions	NA	NA	Generally applicable		Plant-specific	Plants 519, 535-1, 535-2
Air staging	See Section 3.2.2.3.2. Overfire air (OFA): LNBs are operated at low air stoichiometry while complete combustion is achieved by injection of the additional air above the burners in the upper section of the boiler	Reduction of NO _x and CO emissions	High operational experience	NA	Generally applicable		Plant-specific	Plants 75-1, 297, 298, 425-1, 425-2

Flue-gas recirculation (FGR)	See Section 3.2.2.3.3. The adiabatic flame temperature of the LNB can be reduced by recirculating a portion of the flue-gas with the combustion air in the burner windbox. This may make FGR inefficient as a technique for oil firing. Retrofitting requires a new burner design	Reduction of NO _x emissions	The technique is more efficient when burning fuel gas. When burning fuel oil, poor combustion and flame instability may result in malfunctions and increases in dust emissions	Reduced thermal efficiency	Generally applicable	There may be retrofitting constraints associated with safety of the chemical installation	Plant-specific	Plants 154-3, 157-1, 157-2, 364
Low-NO _x burners	See Section 3.2.2.3.5	Reduction of NO _x emissions	High operational experience	NA	Generally applicable		Plant-specific	The majority of boilers of the data collection
Water/steam addition	See Section 3.2.2.3.10	Reduction of NO _x emissions	NA	Reduced thermal efficiency. CO emissions may increase	Applicability may be limited by water availability		Plant-specific	NA
Secondary techniques								
Selective non-catalytic reduction (SNCR)	See Section 3.2.2.3.12	NA	The performance of the SNCR depends on the configuration and geometry of the multi burner furnace	Ammonia slip, possible coating corrosion problems on the boiler water wall tubes	Generally applicable	Safety considerations raised by the proximity of other facilities that could potentially generate explosive atmospheres. For SCR, also space availability, duct size and configuration to intervene in the optimal temperature window	NA	In an example, total capex: EUR 3.5–4 million. NO _x reduction: 62 t/yr
Selective catalytic reduction (SCR)	See Section 3.2.2.3.11	NA	NA	Ammonia slip (less than with SNCR)				Plants 61, 62-2
NB: NA: No relevant specific information available.								

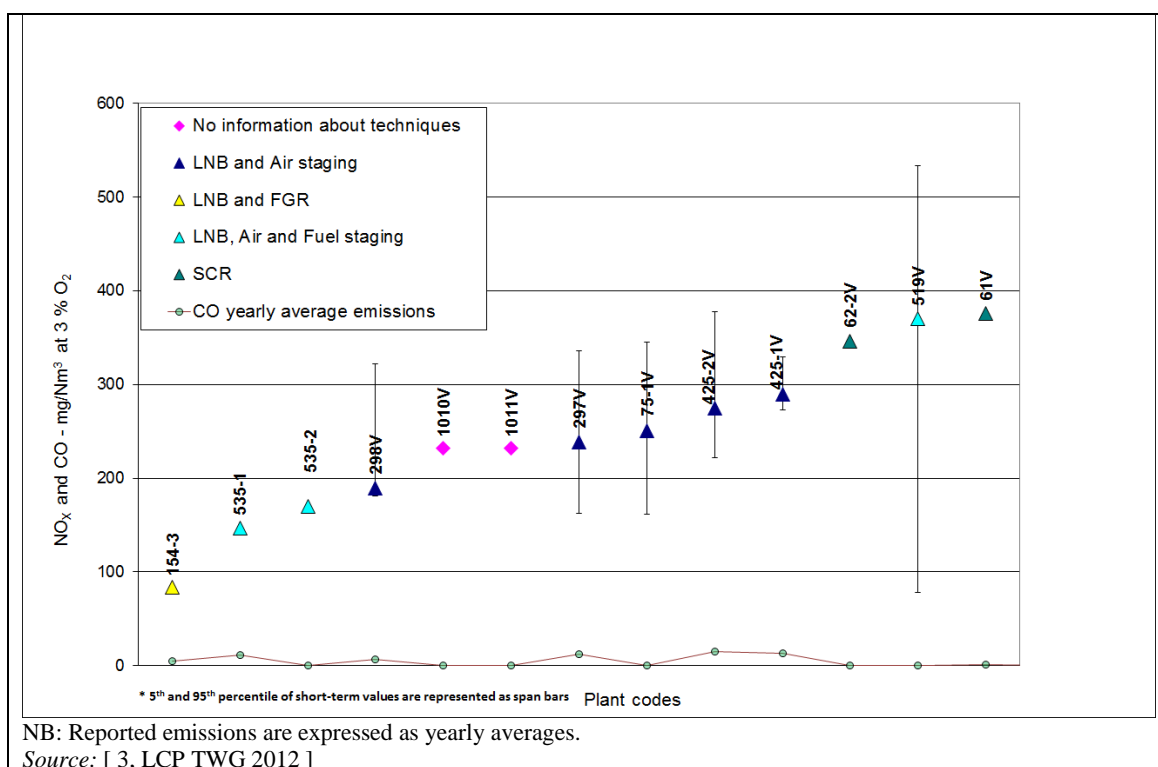

Figure 8.6: NO_x and CO emissions from example boilers firing mixtures of gaseous and liquid process fuels from the chemical industry

Figure 8.6 shows NO_x and CO emission levels achieved by well-performing boilers firing mixtures of gaseous and liquid process fuels from the chemical industry. The plants in this graph are sized between 110 MW_{th} and 870 MW_{th} and are operated between 4 000 h/yr and 8 700 h/yr, with equivalent full load factors above 30 % with the exception of Plant 535-2 which reported an equivalent full load factor of 14 %. Most of these plants are fitted with primary techniques and achieve NO_x emission levels within 290 mg/Nm³ as a yearly average. The plants reporting emissions above this level combust fuels with a high chemical nitrogen content (0.6 % for Plant 519V and up to 23–26 % for Plants 62-2V and 61V which combust a high proportion of nitriles and implement SCR). In all cases, CO emissions are within 15 mg/Nm³ as a yearly average. All these plants were commissioned between 1964 and 1980 and monitor their NO_x emissions continuously or periodically (from 70 to 390 times a year).

Figure 8.7 shows NO_x and CO emission levels achieved by well-performing boilers firing only gaseous process fuels from the chemical industry. The plants in this graph are sized between 140 MW_{th} and 285 MW_{th} and are operated between 1 600 h/yr and 8 700 h/yr, with equivalent full load factors between 17 % and 72 %. All these plants are fitted with primary techniques only and achieve NO_x emission levels within 180 mg/Nm³ as a yearly average. Plants 157-1V and 157-2V combust a high share of hydrogen gas (75 %) and achieve yearly average NO_x levels in the order of 70 mg/Nm³. In all cases, CO emissions are below 20 mg/Nm³ as a yearly average. All these plants were commissioned between 1964 and 2010 and monitor their NO_x emissions continuously.

Figure 8.8 shows NO_x and CO emission levels achieved by well-performing gas turbines firing process fuels from the chemical industry. Plants 279V and 280V are recent plants sized 685 MW_{th} and commissioned between 2005 and 2007. They are operated around 8 000 h/yr, with equivalent full load factors around 84 %. They are fitted with DLN and monitor their NO_x emissions continuously, achieving yearly average emission levels close to 30 mg/Nm³ for NO_x and 1 mg/Nm³ for CO. Plant 372V is sized 150 MW_{th} and achieves similar NO_x emission levels.

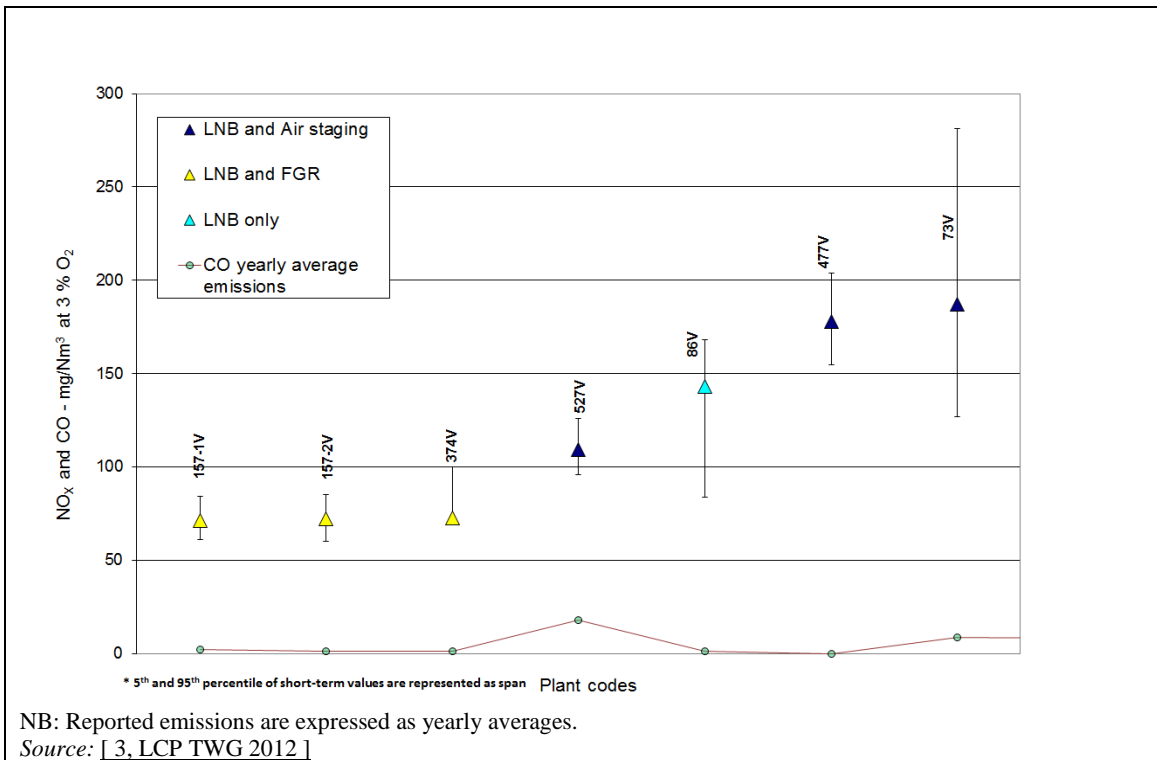

Figure 8.7: NO_x and CO emissions from example boilers firing gaseous process fuels from the chemical industry

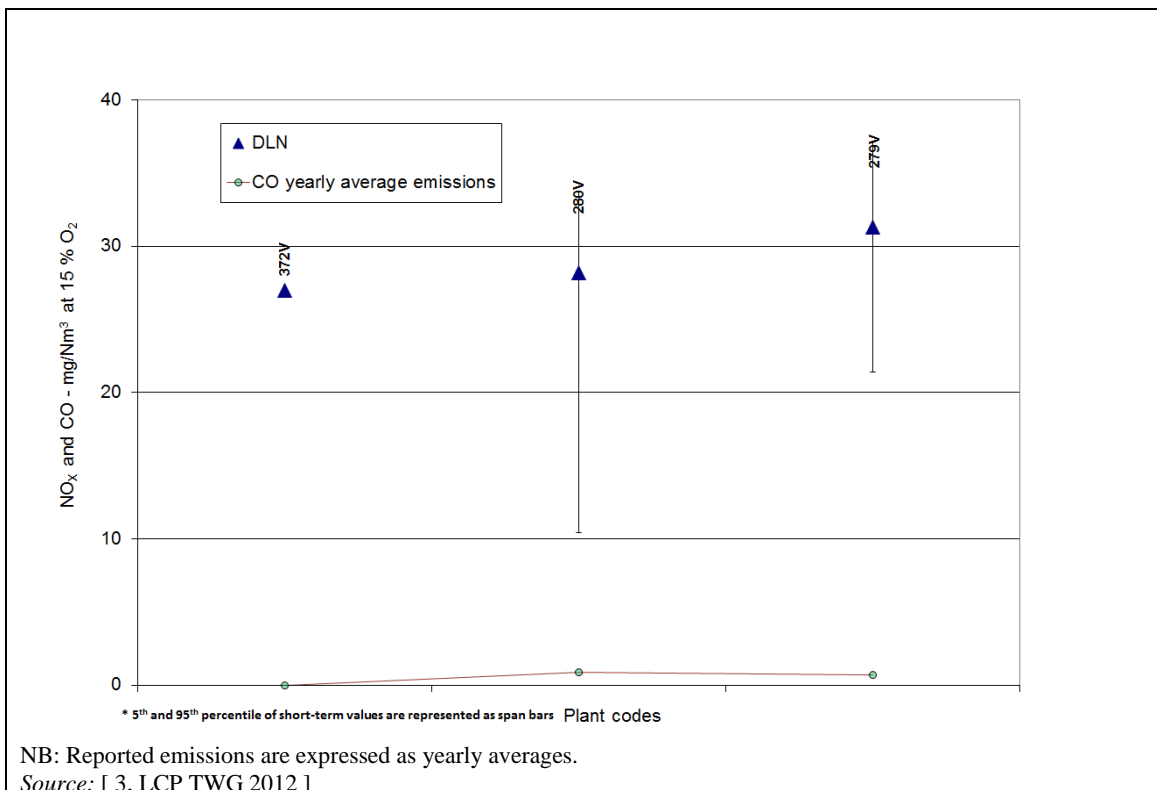

Figure 8.8: NO_x and CO emissions from example gas turbines firing process fuels from the chemical industry



Source: [52, CEFIC 2012]

Figure 8.9: Overfire air technique retrofitted in a boiler at a chemical installation

8.2.3.2 Techniques to prevent and/or control other pollutants

Process fuels from the chemical industry can contain dust and sulphur, as well as halides. These fuels are often burnt with other fuels (e.g. NG, HFO) in combustion plants principally equipped with primary techniques to reduce the emissions of dust, SO_x , HCl and HF; secondary techniques are more often implemented to reduce the NO_x emissions and may be used for dust and acid gas emissions when the primary techniques are not sufficient. See Figure 8.10 (SO_x , HCl and HF emissions) and Figure 8.11 (dust emissions) for performance levels.

Figure 8.10 shows SO_2 , HCl and HF emission levels achieved by well-performing plants firing mixtures of gaseous and liquid process fuels from the chemical industry. The plants in this graph are sized between $110 \text{ MW}_{\text{th}}$ and $370 \text{ MW}_{\text{th}}$ and are operated between 4 000 h/yr and 8 700 h/yr, with equivalent full load factors between 14 % and 85 %. None of these plants are fitted with secondary techniques to reduce SO_x emissions and generally use fuel choice to achieve yearly emission levels within 100 mg/Nm^3 for SO_2 . All these plants were commissioned between 1964 and 1980 and monitor SO_2 emissions either continuously or periodically (from 12 to 70 times a year). The few plants reporting HCl or HF emissions monitor them periodically between three and six times a year.

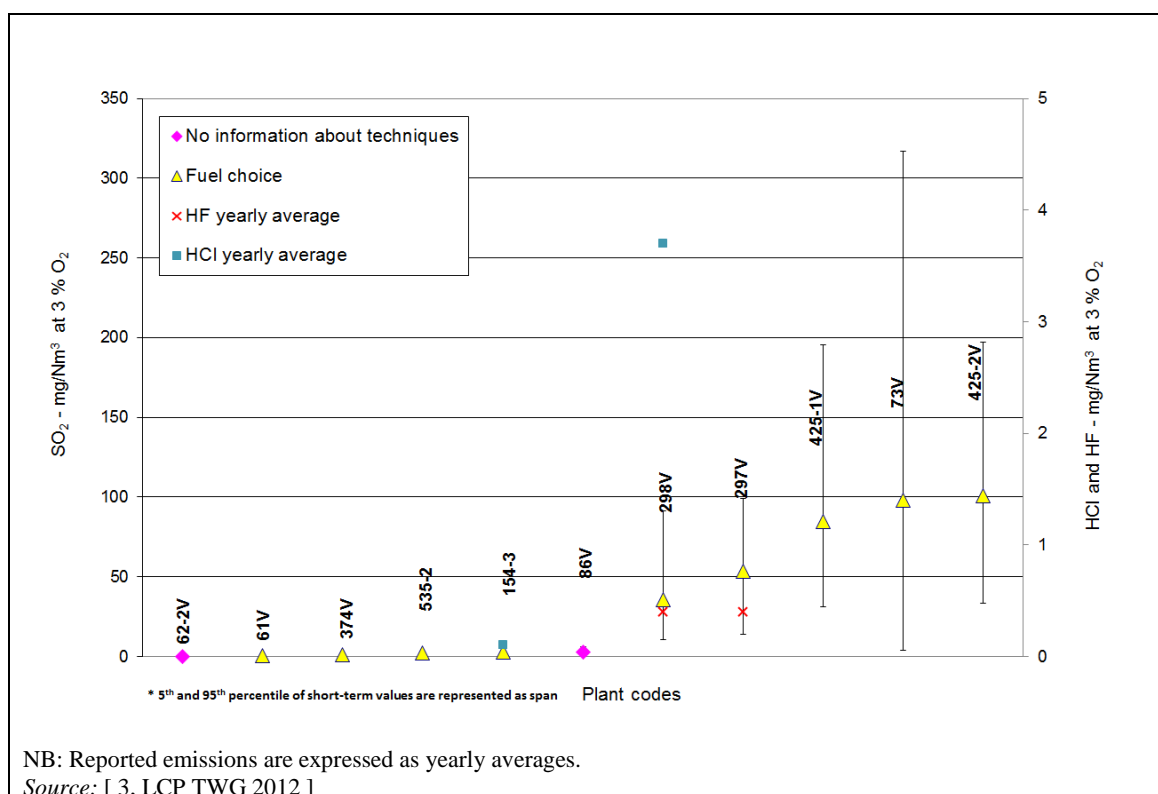

Figure 8.10: SO₂, HCl and HF emissions from example plants firing mixtures of process gaseous and liquid fuels from the chemical industry

Retrofitting certain techniques (in particular secondary techniques for the reduction of SO_x, HCl and HF) in existing boilers within a chemical installation may be difficult due to the size and the configuration of the flue-gas duct or the lack of sufficient space near the boiler.

Figure 8.11 shows dust emission levels achieved by well-performing plants firing mixtures of gaseous and liquid process fuels from the chemical industry. The plants in this graph are sized between 110 MW_{th} and 370 MW_{th} and are operated between 4 000 h/yr and 8 700 h/yr, with equivalent full load factors between 13 % and 72 %. All these plants achieve yearly average dust emission levels within 15 mg/Nm³. These plants were commissioned between 1964 and 1978 and all but one monitor their dust emissions continuously.

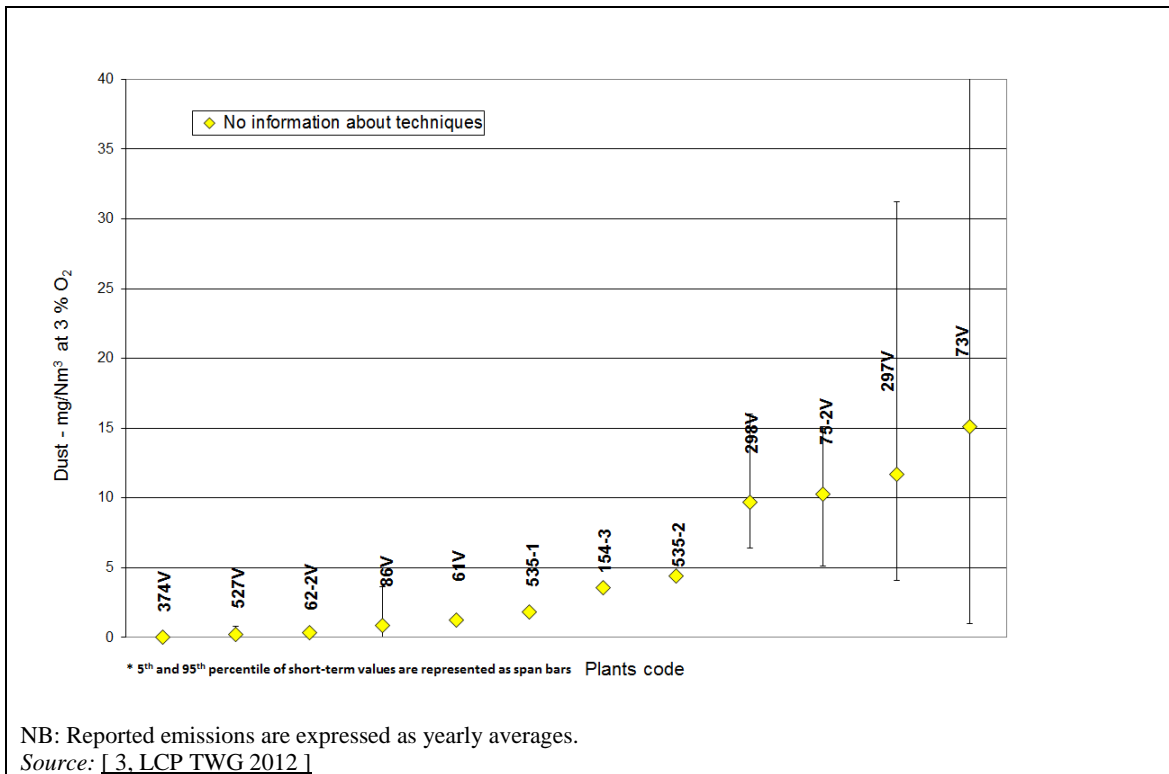

Figure 8.11: Dust emissions from example plants firing mixtures of process gaseous and liquid fuels from the chemical industry

Information on general techniques for the prevention and control of dust and particle-bound metal emissions and SO_x is given in Sections 3.2.2.1, 3.2.2.2, and 3.2.2.5.

Some fuel pretreatment techniques are described in the BAT reference document on Common Waste Water and Waste Gas Treatment/Management Systems in the Chemical Sector (CWW BREF) and in the other chemical industry BREFs.

9 WASTE CO-INCINERATION

This chapter mainly focuses on the effects of the co-incineration of waste materials in large combustion plants (coal-, lignite-, peat-, and wood-fired boilers). Currently, three main factors are driving waste co-incineration in large combustion plants.

- Within the aims of EU-level waste legislation are the reduction of resource use and the minimisation of the amount of waste disposed of. In this context, legislation in certain Member States discourages the disposal of waste and biomass waste with high calorific values (e.g. > 6 000 kJ/kg dry substance). Alternative options to treat these waste fractions include co-incineration as well as incineration and mechanical-biological treatment for example.
- Under the requirements of the Kyoto protocol, greenhouse gas emissions have to be reduced worldwide. The co-incineration of biomass waste and/or other waste fractions with lower specific CO₂ emissions than the fuel they replace is one option to reduce greenhouse gas emissions.
- Liberalisation of the energy market is intensifying economic pressure on energy producers. Waste co-incineration can provide additional business opportunities, which may make the operation of certain large combustion plants more economically attractive.

Waste co-incineration includes materials currently known in literature as waste, solid recovered fuel (SRF), refuse-derived fuel (RDF) or biomass-waste-derived fuel. Some of these materials can be classified as hazardous, as they may be contaminated with hazardous substances. The multi-fuel firing of (non-waste) biomass as defined in the IED is addressed in Section 8.1. Key issues in waste co-incineration are:

- waste quality and characteristics;
- boiler design;
- waste handling and feeding;
- slagging, or bed sintering (fluidised bed boiler);
- fouling of heat transfer surfaces;
- hot corrosion;
- effects on emission levels compared to the emissions that occur when only a conventional fuel is used;
- ash properties, bottom ash removal;
- storage of waste; utilisation and/or disposal options for solid waste/residues from co-combustion.

A wide range of materials can be co-incinerated in LCPs. Annex II (Section 13.2) gives a list of materials currently co-incinerated in LCPs in the EU.

Within the scope of this chapter, it is assumed that co-incinerated waste is (pre-)accepted and then pretreated, which typically involves separating the combustible parts from the non-combustible parts. In order to better understand issues such as the pre-acceptance/acceptance, incineration or pretreatment of waste, see the waste BREFs, in particular the following:

- Waste Treatment (WT): this BREF describes processes and techniques that deal with the transformation of waste in order for it to be used as a fuel in any combustion process (such as in large combustion plants, cement works, chemical works, iron/steelworks, etc.). These pretreatments include sorting, crushing, preparation and so on.

- Waste Incineration (WI): this BREF deals with incineration and covers the types of plants addressed by Chapter IV of the IED or activities listed under point 5.2 of Annex I to the IED.

9.1 Applied processes and techniques

The use of waste as a fuel in large combustion plants involves the use of certain processes and techniques. Techniques related to these activities are described in this section. Cross references are made to other chapters and BREFs where necessary.

9.1.1 Acceptance and pre-acceptance procedures

These procedures are in place to ensure that waste is subjected to appropriate technical appraisal to ensure its suitability for the proposed use as fuel. Health protection for staff and other persons possibly in contact with waste has to be considered. Extensive information about these pre-acceptance and acceptance procedures can be found in the Waste Treatment Industries BREF.

9.1.2 Unloading, storage and handling

The way wastes are unloaded, stored or handled depends on the state of their aggregation and physical properties.

Gaseous wastes are normally transported to power plants through pipelines and fed directly to the burners, without storage. The types of techniques used for these materials are no different to those used for gaseous fuels (see Chapter 7).

Liquid waste can be supplied by ship, train, lorry or pipeline, depending on the availability of transport systems at the location where the waste is produced. Liquid waste can be stored in tanks on site or fed directly into the boiler.

The storage and handling of **solid waste** depends strongly on its physical properties, for example:

- Dried sludge (granulate) can be supplied by ship, train or lorry and is stored in silos or closed bunkers to avoid fugitive dust emissions. Dried sludge should be combusted immediately due to its hygroscopic properties.
- The formation of methane in sludge silos or bunkers has to be controlled by regular air exchange. Air containing methane or odorous compounds should be used as combustion air. During times of boiler stoppage, air exchange and a suitable exhaust gas treatment have to be guaranteed.
- Odorous sludge has to be transported and stored in silos or closed bunkers to prevent odour emissions.
- Wet sludge can be spread over the coal in the coal yard, but the possible generation of odour emissions and dilution into the waste water treatment system have to be taken into account.
- Regarding special provisions for the storage and handling of biomass, reference is made to Section 2.8.

9.1.3 Characterisation and pretreatment of waste streams

This section describes those processes (e.g. grinding, gasification and pyrolysis) applied to prepare the waste for combustion as a gaseous, liquid or pulverised solid fuel. This pretreatment is necessary to assure an adequate burnout in the boiler, due to the short residence time of the fuel in the furnace. The most direct method of co-incineration is mixing with the main fuel. The following pretreatment techniques are described below:

- milling;
- drying (see the WT BREF);
- pyrolysis (see the WI BREF);
- gasification (see Chapter 4 and the WI BREF);
- methanisation (see the WT BREF).

It is important to note that some of these pretreatment techniques are already described in the Waste Treatment and Waste Incineration BREFs. For this reason, no further description is included in this section.

9.1.3.1 Milling

Milling is used to reduce solid wastes to a size that is suitable to be used in the power plant. For example, in fluidised bed boilers the particle size is typically no larger than 100 mm, and in pulverised fuel-fired boilers typically less than 75 μm . Information on the type of milling used with solid fuels is included in Section 5.1.1.2.

9.1.3.2 Drying

Waste that is too wet to be dried in a coal mill needs to be dried elsewhere (pretreated) before it is mixed with the main fuel. Typical examples of waste that may need to be dried are **sewage sludge** and **manure** (e.g. chicken litter) with moisture contents exceeding 50 %.

The drying of the wet waste can take place at the power station or at the location where the waste is produced, recovered or collected. This depends greatly on the local infrastructure and on the kind of waste. Drying of the waste is based on physical and physico-chemical processes of mass and heat transport, resulting in the evaporation of moisture from the fuel. The heat required for the evaporation of the moisture can be supplied by convection or conduction. Since waste drying is not specific to large combustion plants, these processes are not discussed further in this document. More information can be found in the Waste Treatment BREF.

9.1.3.3 Pyrolysis

Pyrolysis is a thermochemical process in which the waste is converted at a high temperature and in the absence of oxygen into gaseous, liquid or solid products. Two types of pyrolysis processes exist:

- **fast pyrolysis processes**, in which the feedstock is rapidly heated to the process temperature, which were developed for the production of pyrolysis oil or specific components of this oil;
- **carbonisation processes**, in which the feedstock is heated slowly to the pyrolysis temperature, resulting in a relatively high solids production.

The solid product of this process (char) contains a high proportion of carbon and can be used as coal. As the liquid and solid materials produced can be stored before co-combustion, the waste can be pretreated independently of power plant operation. The gases produced are often used to supply the heat required for the endothermic conversion process.

Since pyrolysis is not specific to large combustion plants, these processes are not discussed further in this document. More information can be found in the Waste Incineration BREF.

Pyrolysis is used in co-incineration in a pulverised coal- or lignite-fired power plant when the coal or lignite cannot be ground in a coal mill to the required dimensions.

9.1.3.4 Gasification

Some wastes contain impurities such as chlorine, alkali, or metals (e.g. aluminium, heavy metals) in such quantities that they require adequate cleaning before co-incineration in the boiler takes place. Gasification of these materials may be an attractive option. The gas produced by gasification can be burnt directly in the LCP or can be cleaned before use in the LCP or gas turbine. More information can be found in Chapter 4 and in the Waste Incineration BREF.

9.1.3.5 Methanisation

Waste can also be methanised by anaerobic digestion. This technique transforms organic matter to gas (mainly methane), which can be later used in the LCP. Since waste methanisation is not specific to LCPs, these processes are not discussed further in this document. More information can be found in the Waste Treatment BREF.

9.1.4 Techniques to introduce waste into the combustion process

When wastes are co-incinerated in a combustion process, certain procedures need to be applied to ensure proper combustion. Several techniques can be applied to achieve a proper mixing, for example wastes can be mixed together with the main fuel during handling and burnt together. However, other techniques exist where the wastes are introduced into the combustion chamber through feeding lines other than the main fuel's. The different techniques are described in Sections 9.1.4.1 to 9.1.4.4.

9.1.4.1 Mixing with the main fuel

The easiest way to introduce waste into the combustion process is by mixing it with the main fuel and burning it in the combustion chamber or boiler. This may lead to technical and/or environmental constraints in the combustion plant, related to the milling and drying capacity of existing solid fuel mills (if the waste is dried and pulverised together with the main fuel) and to the feeding of the waste.

In a solid-fuel-fired boiler, fuel/waste mixing is possible in the following locations:

- on the fuel conveyor belt;
- in the fuel bunker;
- in the fuel feeder;
- at the fuel mill;
- on the pulverised fuel lines.

In the first three, the waste is spread over the main solid fuel to achieve an adequate mixing of the fuel/waste streams. This results in a grinding of the waste together with the main fuel in the coal mill, as shown in Figure 9.1 for the example of a coal-fired plant. Due to grinding behaviour constraints, this technique is usually only associated with dried sludge.

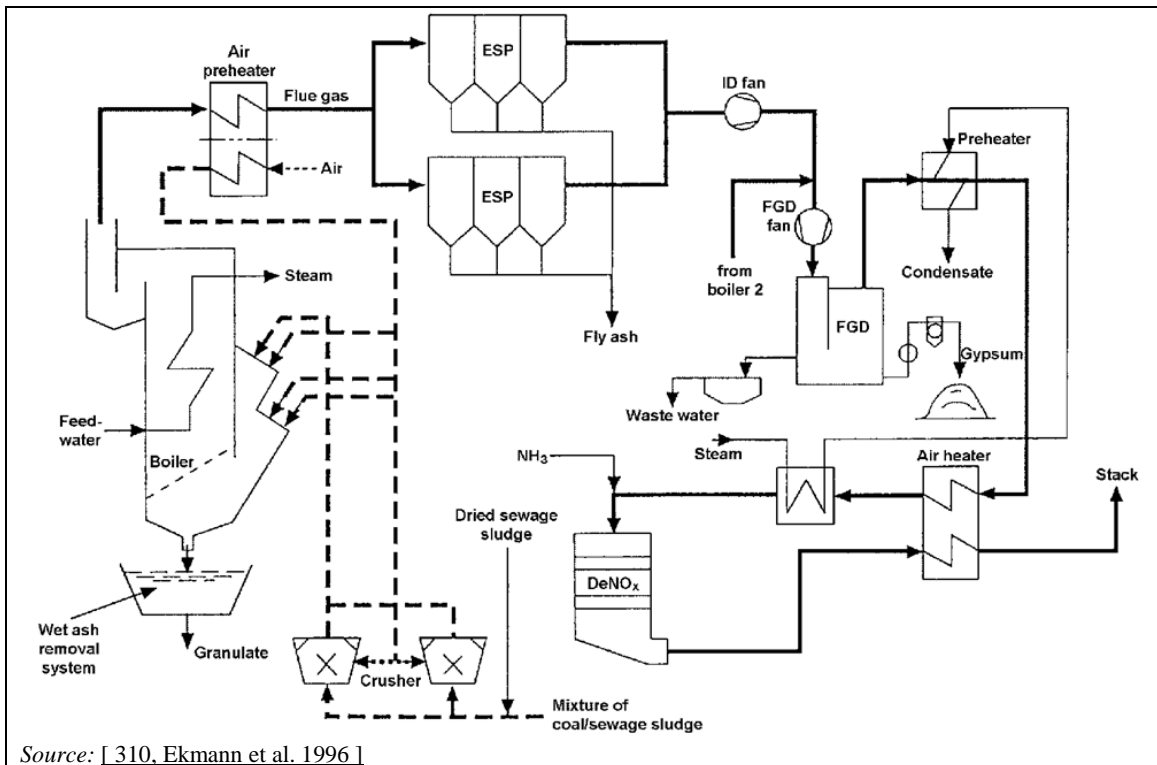

Figure 9.1: Co-incineration combustion of coal and sewage sludge

It is only possible to apply this technique when the grinding behaviour of both fuel and waste are more or less the same or when the amount of waste is very small compared with the main fuel flow. Wastes that are pulverised separately from the main fuel can be injected into the fuel mill or into the pulverised coal pipelines between the coal mill and the boiler.

Other wastes can also be injected into the fuel mill together with the main solid fuel, although they cannot be pulverised. In such cases, to allow for a complete combustion of the larger waste particles, a grate at the bottom of the boiler can be used.

Liquid wastes are typically blended with liquid fuels before the mix is used.

9.1.4.2 Separate lances or modified existing burners

Separate lances or modified existing burners (separate feeding of the waste to the burners) are required to handle waste that cannot be, or is not desirable to be, mixed with the main fuel or to increase the percentage of waste. This occurs when the waste has different physical properties (e.g. viscosity, particle size) or may cause health risks (sewage sludge). This applies, for example, to:

- gaseous fuels or the gaseous product streams from gasification, pyrolysis or pre-combustion processes that are to be burnt with a solid or liquid fuel;
- liquid fuels or the liquid product streams from pyrolysis processes;
- pulverised solid fuels.

The burners need to be specially designed for the particular fuel/waste in order to achieve good ignition, a stable flame, and good mixing with the main fuel flame in the boiler. The location of these burners in relation to the main burners is important for the good burnout of the fuel.

9.1.4.3 Special grates

Special moving grates at the bottom end of the boiler hopper used for the introduction of waste lengthen the residence time of the waste in the furnace. Such systems typically avoid the need to pretreat the waste.

Figure 9.2 gives a schematic drawing of the grates ($2 \times 5 \text{ MW}_{\text{th}}$) at the bottom end of a boiler, together with the coal burners, in an example drawn from a plant in Austria. In this example, biomass waste is fed into the boiler at the small front sides of the grates, which transport the fuel during combustion to the centre of the boiler. Ash from the biomass and bottom ash from the coal combustion, with less than 5 % unburnt carbon, fall into the slag remover below the grates. The resulting flue-gases from the grate rise directly into the furnace, without any heat losses.

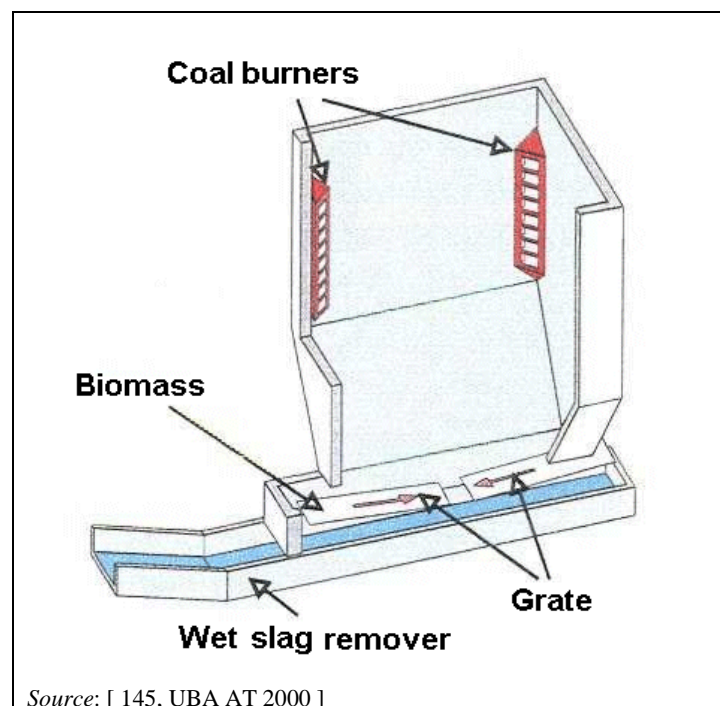

Figure 9.2: Internal grates in a pulverised coal-fired boiler

9.1.4.4 Feeding wastes into a fluidised bed boiler

In fluidised beds the fuel does not need to be pre-milled but only crushed to particles typically smaller than 5–20 mm although coarser fragments up to around 100 mm are accepted. This fuel flexibility is an advantage in waste co-incineration. Large inert objects such as stone or glass should nevertheless be removed, and some further precautions need to be taken, as described below.

For co-incineration in a fluidised bed boiler, the appropriate feeding of the main fuel and of the waste is one of the most essential factors for good operation. Other important factors are the good quality and low level of impurities (metals, glass, etc.) of the mixed fuel.

Good operation and maintenance of the screening and crushing equipment are also very important. Practical problems can occur when higher amounts of waste of a different quality to the primary fuel are fed into the boiler for short periods. This can cause disturbances in the combustion process and also affect the load of the boiler. In fluidised bed combustion, sintering problems can occur.

In conveyors, some operating problems can occur due, for example, to blockages caused by long pieces of bark or plastics. These problems can be avoided by proper maintenance of the crushing system.

Waste should be properly mixed with the main fuel before being fed into the boiler, or there should be a separate feeding system for the waste so that the feeding can be quickly stopped in the event of any problems.

9.1.5 Control of emissions to air from waste co-incineration

Flue-gas cleaning processes and techniques applied to the co-incineration of waste do not necessarily differ from the techniques for cleaning flue-gases from the combustion of solid, liquid or gaseous fuels as described in Chapters 5 to 7. Depending on the properties of the waste, in particular the content of metals including for instance mercury, sometimes additional measures, such as an injection of activated carbon, are applied.

The pollutants SO_x , NO_x and dust are effectively controlled at power plants that are properly designed and well operated. A higher input of these pollutants into the firing system can be balanced (clearly within certain limits) by adaptation of the flue-gas cleaning system and will normally not lead to higher emissions.

Reduction of HCl and HF emissions is strongly correlated with SO_x reduction. The input of chlorinated compounds is limited by the operator of the power plant also to prevent high-temperature corrosion.

9.1.6 Waste water generation and treatment

Aqueous releases arise from processes such as wet scrubbing, plume conditioning, wet deslagging, and storage and pretreatment of waste (e.g. drying of sewage sludge). Neutralisation, settlement and physico-chemical treatments may be necessary to remove any contaminants from the water streams generated. Water and waste water treatment systems applied in waste co-incineration do not differ from the techniques for the treatment of water and waste water from gaseous-, liquid- or solid-fuel-fired LCPs, as described in Sections 3.1.10 and 3.2.4. If necessary, existing waste water treatment systems can be adapted to the removal of higher loads of pollutants (e.g. Cl, F, Hg).

9.1.7 Management of combustion residues

The handling of combustion residues applied with waste co-incineration does not differ from those techniques for handling combustion residues from gaseous-, liquid- or solid-fuel-fired LCPs, as described in Sections 3.1.11 and 3.2.5. Fly ashes and bottom ashes are generated during the combustion processes.

While waste incineration plants are typically equipped with complex combinations of flue-gas cleaning techniques able to deal with broad chemical composition variations in the waste, certain categories of combustion plants are often not equipped with systems dedicated to the reduction of metals and mercury in particular (such as one- or two-stage wet scrubbers and activated carbon systems). Therefore, if no further actions are taken, emissions of these pollutants to air may increase (depending on the input) as may their concentration in the fly ash, in the gypsum, or in other solid residues from FGD. If the gypsum is washed, the emissions to water may also increase.

As the utilisation or disposal of solid residues from combustion is an important economic factor, operators of power plants carefully control their quality so as not to lose established utilisation

pathways (mostly by limiting the input of waste into the firing system). Important parameters are the content of alkalis, sulphates, chlorides, silicates, unburnt carbon and metals (depending on the specific situation). If solid waste from co-incineration has to be landfilled, the concentration of metals for example and also the leaching behaviour have to be measured.

9.2 Current emission and consumption levels

9.2.1 Overview of the waste co-incinerated in LCPs

Waste co-incineration impacts on plant energy efficiency, on emissions to air and water, and also affects the quality of the combustion residues.

The level of impact is determined by how the properties of the waste differ from those of the main fuel and by how much, and by the reduction/abatement techniques implemented. The main physico-chemical properties, which describe the quality of a fuel, are:

- calorific value;
- ash content;
- water content;
- volatile matter; and
- chemical composition (especially in terms of C, H, O, N, S, Al, K, Na, P, Cl, F, as well as Hg and other metals).

The main types of waste that are used for co-incineration in LCPs are listed in Annex II (Section 13.2), the most important ones on this list in terms of volume being sewage sludge, paper mill sludges and residues, waste-derived fuels from the processing of municipal and commercial waste, animal tissue waste and treated wood waste.

Waste-derived fuels are mainly solid or liquid with a significant amount of ash. For this reason, co-incineration is more or less limited to the application in solid-fuel-fired boilers. Some of these materials can be classified as hazardous, as they may be contaminated with hazardous substances. Table 9.1 to Table 9.3 show examples of waste co-incinerated in coal-fired combustion plants and of their composition. In this context, reference is also made to Table 5.1 and Table 5.2 presented in Chapter 5 concerning the combustion of coal and lignite.

Table 9.1: Example of coal/lignite and some typical sewage sludge compositions

Parameter	Units	Range (lignite and coal)	Range (sewage sludge; municipal – industrial)
Water content	wt-%	3–60	65–75
Calorific value H _u	MJ/kg dry mass	7–38	9–12
Ash content	wt-% dry	3–17	40–60
Volatiles	wt-% dry	17–60	13–47
Fixed C	wt-% dry	19	1
C	wt-% dry	60–80	30–50
H	wt-% dry	3–9	4–7
N	wt-% dry	0.5–2	2–4.7
S	wt-% dry	0.5–3	0.5–2
Cl	mg/kg dry mass	200–300	500–3 000
F	mg/kg dry mass	16–20	100–350
As	mg/kg dry mass	0.4–18	4–9.2
B	mg/kg dry mass	No data	30–55
Ba	mg/kg dry mass	No data	300–500
Be	mg/kg dry mass	0.1	0.9–2
Pb	mg/kg dry mass	0.4–50	15–412
Cd	mg/kg dry mass	0.02–5	0.6–6.5
Co	mg/kg dry mass	0.6–21	2–13.4
Cr	mg/kg dry mass	1.4–39.1	40–108.6
Cu	mg/kg dry mass	1–33	30–456
K	mg/kg dry mass	No data	1 500–2 300
Mn	mg/kg dry mass	88–160	210–1 000
Na	mg/kg dry mass	No data	1 100–4 400
Ni	mg/kg dry mass	1.6–40.5	30–57
Hg	mg/kg dry mass	0.1–0.3	0.2–4.5
Se	mg/kg dry mass	No data	< 5
Sb	mg/kg dry mass	1–5	2.4–8.5
Th	mg/kg dry mass	0.1–0.3	1.2–2
V	mg/kg dry mass	1–105	9–35.4
Sn	mg/kg dry mass	4	10–100
Zn	mg/kg dry mass	5–60	420–1 600
AOX	mg/kg dry mass	No data	350

Source: [145, UBA AT 2000] [3, LCP TWG 2012]

Because of the different origins of secondary wood fuel such as waste wood, demolition wood (with and without wood preservatives) and pressboard residues, the impurities and contamination levels may vary widely. Table 9.2 shows the variation in impurities and the contamination of different waste wood examples, where some of these contain wood treated with wood preservatives (e.g. demolition wood).

Table 9.2: Example compositions of waste wood types used in LCPs

Element	Units	Waste wood A	Waste wood B	Waste wood C	Demolition wood
Nitrogen	(mg/kg)	NA	7 600	7 300	2 400
Sulphur	(mg/kg)	1 000	< 20	5 500	1 700
Chloride	(mg/kg)	2 000	200	320	1 184
Fluoride	(mg/kg)	120	3	50	88
Cd	(mg/kg)	10	1	NA	4.1
Hg	(mg/kg)	1	< 0.5	NA	1.5
As	(mg/kg)	2	1	NA	4
Co	(mg/kg)	2	NA	NA	4.1
Cu	(mg/kg)	1 000	16	23	1 388
Cr	(mg/kg)	120	19	32	48
Mn	(mg/kg)	100	NA	NA	NA
Ni	(mg/kg)	20	4	5	15.8
Pb	(mg/kg)	1 000	140	510	762
Sb	(mg/kg)	10	NA	NA	11.8
Zn	(mg/kg)	20	12	NA	23.5

NB:
NA: Not available.
Source: [311, Hein et al. 2000.]

Table 9.3: Variation of impurities in different wood – waste mixtures

Substance	Units	Bark	Larch - chips	Bark + chips + dried sewage sludge	Bark + chips + wood from demolition	Bark + chips + plastics	Bark + pressboard + plastics from electronic scrap recovery
Carbon	%	49.78	51.01	47.06	48.69	50.64	50.43
Hydrogen	%	5.41	6.10	5.59	5.77	5.73	5.75
Oxygen	%	36.98	42.28	30.06	36.17	36.85	34.95
Nitrogen	%	0.45	0.21	2.82	1.48	0.70	1.42
Total sulphur	%	0.04	0.02	0.40	0.12	0.05	0.09
Ash	%	7.34	0.38	14.07	7.77	6.03	7.37
Combustibles	%	92.66	99.62	85.93	92.23	93.97	92.63
Volatiles	%	69.06	83.04	66.70	72.71	71.39	70.56
H _o	kJ/kg	19 658	20 380	19 111	19 601	20 112	20 351
H _u	kJ/kg	18 478	19 050	17 891	18 343	18 862	19 097
Chloride	% Cl	0.000	0.000	0.112	0.035	0.071	0.135
Fluoride	% F	0.000	0.000	0.012	0.003	0.004	0.004

Source: [145, UBA AT 2000.]

9.2.2 Degree of waste co-incinerated in LCPs

Generally, waste participation for co-incineration in combustion plants is lower than 10 % on a thermal basis. References with higher waste participation rates are usually associated with fluidised bed boilers or with the co-incineration of separately pulverised wood waste in pulverised coal-fired boilers. In Sweden, plants burning up to 100 % waste (mainly biomass waste) have been considered co-incinerating plants.

Large-scale demonstrations have been performed with sewage sludge and wood chips since the early 1990s. Following the BSE (bovine spongiform encephalopathy) crisis in 2000, particular emphasis was placed on the possibilities for co-incinerating animal tissue waste and bonemeal in power plants. In response to the EU Landfill Directive, since 2005 increasing focus has been

placed on the energy recovery of the organic waste fractions of municipal, commercial and industrial waste flows. Nowadays, co-incineration of sewage sludge, sludges and residues from the pulp and paper industry, waste-derived fuels, animal tissue waste, and other industrial waste and process residues is common practice at many coal- and/or lignite-fired large combustion plants across Europe.

Table 9.4 includes an overview of some power plants where wastes have been co-incinerated.

Table 9.4: Experience with waste co-incineration in some LCPs in some EU Member States

Country	Main fuel type	Waste streams co-incinerated	Boiler type	Total rated thermal input (MW)	Gross electric power output (MW)	Co-firing degree (thermal)	Remarks / handling of waste
Austria	Coal	Sewage sludge	WBB	543	246	0.1 %	
France	Biomass	Paper sludge and residues, waste wood, sewage sludge	CFBC	85	9	Varying	Degree of co-incineration over 25 %
France	Coal	Meat/bonemeal, biomass	CFBC	81	12	9.3 %	
Finland	Peat, woody biomass, (coal)	Waste-derived fuel	CFBC	206	65	8.4 %	Multi-fuel co-combustion of peat, coal, biomass and waste
Finland	Peat, coal, biomass	Waste-derived fuel	CFBC	65	NA	NA	
Germany	Lignite	Sewage sludge	DBB	2 × 2465	2 × 920	1.5 %	Mixing with lignite before pulverisation
Germany	Coal	Sewage sludge, meat/bonemeal	WBB	2100	838	1.0 %	Mixing of waste with the main fuel before feeding together
Germany	Coal	Sewage sludge	DBB	1370	550	0.1 %	
Germany	Lignite	paper sludge, waste-derived fuel, premixed waste	DBB	2 × 2100	2 × 800	1.9 % / 1.6 %	Mixing with lignite before pulverisation
Germany	Lignite	Waste-derived fuel	DBB	4 × 762	2160	2.2–3.5 %	Mixing with lignite before pulverisation
Germany	Coal	Sewage sludge, petroleum coke	DBB	1870	824	< 5 %	
Germany	Coal	Waste-derived fuel	WBB	1528	658	3.9 %	Mixing of waste with the main fuel before feeding together
Germany	Coal	Liquid waste and waste gases from the chemical industry	WBB	710	247	< 10 %	Integration of chemical production and steam/power production
Germany	Lignite	Sewage sludge, meat/bonemeal	DBB	1524	500	< 2 %	Mixing with lignite before pulverisation
Germany	Coal	Sewage sludge	DBB	1125	474	< 5 %	

Germany	Coal	Meat/bonemeal, waste-derived fuel	WBB	856	320	2 %	
Germany	Coal	Sewage sludge, waste-derived fuel, meat/bonemeal	WBB	887	320	1 %	
Germany	Coal	Waste-derived fuel	CFBC	80	30	5 %	
Germany	Coal	Waste-derived fuel, wood chips	CFBC	3 × 118	3 × 36	13–17 %	
Germany	Coal	Waste-derived fuel, paper sludge, sewage sludge	CFBC	89	20	< 20 %	
Germany	Lignite	Sewage sludge, waste-derived fuel, waste wood & biomass	CFBC	550	107	< 25 %	2 CFBC boilers
Germany	Lignite	Sewage sludge	CFBC	732	201	< 25 %	
Italy	Coal	Meat/bonemeal, biomass	DBB	418	165	6.0 %	
Italy	Coal	Meat/bonemeal, biomass	DBB	433	171	6.3 %	
Italy	Coal	Waste-derived fuel	DBB	793	320	2.4 %	
Sweden	Biomass, peat	Solid waste fuel	CFBC	138	45	8.0 %	
Sweden	Coal	Rubber waste, wood chips	GF	74	16	45.3 %	
Sweden	Biomass	Waste wood, solid waste	Other	74	16	Varying	Degree of co-incineration over 25 %
Sweden	Peat, biomass	Waste wood, animal by-products	CFBC	50	6	Varying	Degree of co-incineration over 25 %
Sweden	Biomass	Rubber waste	CFBC	146	40	20 %	
United Kingdom	Biomass	Solid waste fuel	DBB	69	11	24 %	
NB: DBB: dry-bottom boiler; WBB: wet-bottom boiler; CFBC: circulating fluidised bed combustion; GF: grate firing. Source: [3, LCP TWG 2012]							

In Germany, co-incineration of waste has been common practice at many coal- and/or lignite-fired power plants since the early 1990s. Currently, there are around 40 coal- and/or lignite fired power plants in the public power sector and the coal and lignite mining sector co-incinerating waste with a co-firing degree of up to 25 % of the rated thermal input. In 2009, around 2.8 million tonnes of waste were co-incinerated in German power plants including around 1.3 million tonnes of sewage sludge, 0.5 million tonnes of sludges from the pulp and paper industry and 0.6 million tonnes of waste-derived fuels from the processing of household and commercial waste as well as 0.4 million tonnes of animal tissue waste, contaminated waste wood and other industrial waste materials. [63, BDEW 2013]

Furthermore, many industrial auto-producers in the pulp and paper, wood processing, chemical and refining industry also co-incinerate industrial waste and residues stemming, among others, from internal production processes in large combustion plants for electricity, heat and steam generation.

In 2009, 63 power plants reported co-incineration of waste in the EU Emissions Trading System (ETS). Of these ETS installations, 54 power plants achieved greenhouse gas emission reductions through the co-incineration of waste rather than the main fuel. The combined CO₂ emission reduction through co-incineration in Germany was calculated by the German Emission Trading Authority to amount to 1.8 million tonnes of CO₂ in 2008 and 2.1 million tonnes in 2009. [86, Eurelectric 2013]

9.2.3 Effects of waste co-incineration on plant energy efficiency

When a plant is fired with a fuel/waste mix, the conversion efficiencies of the energy inputs of the individual fuel/waste streams to the energy output have to be considered. This means that, to characterise the effect of co-incineration on plant energy efficiency, it is necessary to determine both the conversion efficiency from waste to energy output, and the influence of co-incineration on the conversion efficiency of the main fuel.

The efficiency of the conversion from waste to energy is influenced by:

- the moisture content of the waste;
- the waste reactivity;
- the grindability of the waste;
- the efficiencies of the required pretreatment processes before combustion;
- the required house load for handling and pretreatment of the waste;
- the calorific value;
- the ash content.

Waste co-incineration can influence the conversion of the main fuel to energy output in the following ways:

- excess air may be needed to ensure proper combustion;
- the flue-gas temperature and flow in the boiler may change;
- there may be increased unburnt carbon in the fly ash;
- steam temperatures may change;
- the net energy efficiency may be affected by the energy requirement for drying waste on or off site.

9.2.4 General effects of waste co-incineration in LCPs

The handling, and in particular the combustion, of waste can lead to additional challenges that may affect the emission levels, the plant's energy efficiency and availability, and the quantity and quality of the residues, by-products and waste water. These effects are influenced by the nature of the waste, in particular with regard to its:

- toxicity (also pathogenic germs);
- explosion risk (gaseous fuels and dust explosions);
- flammability (liquid fuels);
- moisture content;
- spontaneous heating (biomass);
- odour;
- fluidity (for sludge and solids);
- grindability.

These aspects have to be considered when choosing the waste, to enable proper and safe co-incineration.

9.2.5 Effect of waste co-incineration on plant performance

Apart from the possible influence of humidity or ash content on plant energy efficiency, co-incineration may also influence the plant's performance. This may result in a decrease in the nominal load or the load control speed of the power plant, caused by the capacity constraints of the components. For example, the capacity of the induced draught flue-gas fans can limit the co-incineration degree of wet waste. Plant performance (and availability) may also be influenced by corrosion (due to the sulphur and chlorine contents of the waste), erosion, slagging, or fouling (due to the alkali content of the ash) of the boiler. Adapting the LCP equipment for the pretreatment or pre-conversion of the waste, or limiting the degree of co-incineration, helps prevent a decline in plant performance.

Plant energy efficiency and plant performance can be increasingly influenced the further the waste deviates from the original design fuel(s) of the boiler. The issues that can be of relevance when considering such influences include:

- the existing design capacity of combustion plant equipment (e.g. due to the requirement for a higher wet flue-gas flow in the co-incineration of wet waste);
- the combustion characteristics of the waste, such as ignition, flame stability, flame temperature, NO_x formation and burnout, which may differ from those of the main fuel;
- slagging and fouling, influenced by the chemical composition of the ash (especially potassium, sodium and sulphur) and the melting trajectory of the ash;
- the thermal behaviour of the boiler, especially radiant and convective heat exchange;
- corrosion and erosion by salts of boiler parts (caused by sulphur and chlorine compounds in the waste and the operating conditions in the boiler combustion, e.g. the reducing air);
- the quality and behaviour of the by-products and combustion residues;
- emissions to air caused by the sulphur, chlorine, heavy metals, organic substances, etc. contained in the waste;

- emissions to water caused by the sulphur, chlorine, heavy metals, organic substances, etc. contained in the waste;
- impacts on the flue-gas cleaning systems due to changes in the composition of the flue-gas (especially deactivation of the DeNO_x catalysts by alkalis, As, P or F; increased fly ash separation by ESPs; effects on the FGD);
- emissions to air and water from waste pretreatment (e.g. drying of sewage sludge).

These impacts can be addressed by limiting the degree of co-incineration to only a small portion of the main fuel and/or by proper pretreatment of the waste.

9.2.6 Effects of waste co-incineration on emissions to air

The chemical composition of the co-incinerated waste is the main factor determining the impact on emissions to air. Concentrations of certain elements such as mercury can be higher in waste than in the main fuel, and can thus result in higher concentrations of those elements in the raw flue-gas. Higher emissions to air of those pollutants may however be avoided by waste selection and pretreatment measures as well as (additional) primary or secondary air emission control techniques.

9.2.6.1 Dust

Dust emissions from the stack may change with co-incineration due to the different physical and chemical composition of the ash, which can affect the ESP performance in particular. Dry solid waste prone to releasing very fine particles could give rise to fugitive dust emissions, especially in handling and storage areas.

Dust is present in flue-gas for a number of reasons. Some of it is related to the ash entrained in the flue-gas by turbulent conditions in the combustion chamber. Light wastes are particularly prone to this. Similarly, the flue-gas can entrain partially burnt waste.

Compounds and metals, such as cadmium and especially mercury volatilised in the combustion chamber, can condense into particulate matter when the temperature drops after combustion. This material can form a submicron fume that can be difficult to remove. Particulates can also be generated by routine online cleaning, such as during soot blowing.

9.2.6.2 Acid gases

Depending on the type of waste co-incinerated, higher emissions of acid gases may result. These gases are hydrogen chloride, sulphur dioxide, hydrogen fluoride and nitrogen oxides. The concentrations of various compounds in the waste determine the levels of the respective acid gases in the raw flue-gas and thus the abatement techniques to be applied.

9.2.6.3 Carbon oxides

The specific fossil-fuel CO₂ emissions of a combustion plant may significantly decrease when renewable secondary fuels, wastes with a high biogenic content or other wastes with a lower specific CO₂ emission factor than the main fuel are co-incinerated, provided that the overall plant efficiency is not adversely affected by the co-incineration. In the context of climate change mitigation policy, this is one of the primary goals, in particular in LCPs subject to the European Emission Trading scheme, of the widely applied multi-fuel firing of biomass wastes and secondary fuels with high biogenic contents, as the replacement of the primary fossil fuel

reduces the emission of fossil CO₂, whereas the renewable CO₂ originating from the biogenic waste fractions is not accounted for.

Emissions of carbon monoxide may be affected as co-incinerating waste may cause an impact on certain combustion characteristics (e.g. flame stability). However, the design and operation measures needed to achieve correct incineration of the waste should prevent carbon monoxide emissions from rising significantly in co-incineration.

9.2.6.4 Halides

Halide emissions may be higher in the co-incineration of waste with high Cl and/or F contents. Since chloride and fluoride are not necessarily completely abated by the typical flue-gas cleaning installations of solid-fuel-fired power plants, the emission of these substances may be higher than in dedicated waste incinerators if no further action is taken. In the case of fluoride in particular, emissions tend to be higher when a gas-gas heat exchanger is applied for reheating the cleaned flue-gases from the FGD.

9.2.6.5 Nitrogen oxides

The waste fuel may have a beneficial or detrimental impact on NO_x emissions, depending on how similar the waste or recovered fuel is to the fuel with which it is co-fired. Highly-volatile coals may increase the flame temperature, thereby potentially forming more NO_x. Waste with a high percentage of moisture ignites slowly with a low adiabatic flame temperature, thereby forming less NO_x. Installations with NO_x abatement techniques have greater flexibility to accept waste with a higher fuel-nitrogen content.

9.2.6.6 Sulphur oxides

Waste with a much higher sulphur content than the main fuel (coal, lignite, biomass, peat) can in certain cases cause higher SO_x emissions, although the limited co-firing rate and the use of adequate SO_x removal techniques should keep such emission increases to a minimum. In any case, it is more common for the waste to have a lower sulphur content than the primary fuel, resulting in lower overall emissions of sulphur compounds.

9.2.6.7 TOC, VOCs and dioxins

Volatile organic compounds (VOCs) in the flue-gas represent unburnt fuel. Co-incineration can lead to an increase in the emissions of VOCs. However, the emissions of hydrocarbons, VOCs and PAHs do not change significantly in co-incineration when a good burnout is achieved.

[123, Eurelectric 2001]

Dioxins and dioxin-precursor substances can be present in wastes, such as demolition wood and refuse-derived fuel (RDF), in small quantities and are destroyed in the combustion chamber. However, they can subsequently reform by the *de novo* synthesis process, from precursors such as chlorinated benzenes, PCBs or non-chlorinated precursors, where there is an associated supply of inorganic chlorine. The mechanism for their reformation is not fully understood, but it is thought that the presence of copper, soot and fly ash can assist in the process, which occurs mostly between 200 °C and 450 °C. Due to these effects, it has been identified that the co-incineration of certain types of waste may result in higher dioxin emissions. Dioxin emissions can be reduced with specific techniques such as activated carbon injection in the flue-gases.

Emissions of dioxins and furans from coal-fired plants are typically low due to their specific combustion characteristics and the sulphur content of the fuel which impedes the formation of

these compounds. This does not change with co-incineration, even in the case of waste with a high chlorine content.

9.2.6.8 Metals (Cd+Tl; Hg; Sb+As+Pb+Cr+Co+Cu+Mn+Ni+V)

Metals (e.g. heavy and toxic metals) are already present to a certain extent as natural elements in fossil fuels. Certain wastes such as sewage sludge and fuel derived from waste or the demolition of wooden constructions may contain metals, as shown in Table 9.1 and Table 9.2, in a higher quantity than in conventional fuel.

Some metals remain in the furnace bottom ash while others in the flue-gas may condense downstream from the combustion chamber, where they form particulates. Some highly volatile metal compounds such as cadmium, mercury, thallium and selenium will remain in the vapour phase or in an ultrafine fume. Regarding waste composition, the Hg concentration is typically one of the most critical of all elements because of its volatility [123, Eurelectric 2001]. Due to the general limitations of the waste input (only a few per cent of the total thermal input of a power plant usually come from co-incinerated waste) and due to comparable concentrations of Hg in the raw gas of pure coal-fired power plants, the raw gas concentration of Hg does not increase significantly. However, emitted loads may increase as a result of the higher flue-gas volumes. For other metals, some emission increases may occur due to possibly higher concentrations of Pb, Co, Tl, and Se. [123, Eurelectric 2001]

9.2.6.9 Plume

Wastes with a high moisture content, such as poultry litter, are prone to visible plume formation. There are three generic techniques for conditioning exhaust gases to prevent visible plume formation from the stack:

- exhaust gas reheating;
- exhaust gas condensation;
- flue-gas temperature control.

Condensation techniques produce large volumes of liquid for disposal, which can be contaminated by polluting substances and may require neutralisation.

9.2.6.10 Odour

The storage and handling of waste such as odorous sludge can generate odour emissions. Drying installations in particular need to apply techniques against odour emissions, as described in the Emissions from Storage BREF. Depending on the waste and on the local situation, storage, transfer and handling may take place in enclosed areas.

9.2.7 Effects of waste co-incineration on emissions to water

Waste co-incineration can influence emissions to water. However, most sources of waste water, such as cooling water, condensate or demineralised waste water, are not affected by co-incineration. The sources of waste water that may be influenced are listed below:

- Rinsing waters from waste storage and surface run-off (rainwater).
- The common factor in all dewatering (drying) processes is that the separated water (filtrate or decant water) is polluted to differing extents. This is particularly true when

dewatering at higher temperatures, and may represent an important source of secondary pollution burden for the water treatment plant.

- As described in Chapter 3, flue-gas desulphurisation is the main source of waste water, as it removes SO₂ as well as other pollutants, such as heavy metals, from the flue-gases. Although the concentration of metals in the effluent of the waste water plant is related to the influent concentrations, it can be treated to a certain extent by adjusting the type and amount of chemicals used and should be only slightly affected by co-incineration.
- The use of water for dust control of open fuel storage can result in waste water, if this water is not internally reprocessed, which is normally the case for coal storage. If waste is not stored or handled properly, rainwater may also become contaminated unnecessarily. 'Good housekeeping' will prevent substances being spilled and transferred to drains.
- Condensation techniques applied to plume conditioning produce large volumes of liquid for disposal, which may be contaminated by polluting substances and may require waste water treatment.
- The storage and handling of liquid wastes may involve the risk of dilution into the waste water treatment system. The use of wet sludge spread over the coal in the coal yard might also involve dilution into the waste water treatment system.

9.2.8 Effects of waste co-incineration on the quality of combustion residues

A key fundamental of co-incineration is to prevent a decrease in the quality of combustion residues. This has to be achieved by pretreatment of the waste or by limiting the degree of co-incineration. The quality of residues has two aspects: technical and environmental quality.

- The technical quality is the expression of various parameters, which together determine, to a large extent, the usability of the residues as a by-product. Apart from the purely physical properties (e.g. stiffness, porosity, particle size, moisture content), the contents of elements such as chloride, phosphorus, sulphate and carbon are also important. This applies especially to ashes in concrete and cement.
- The environmental quality of the by-product is related to how substances that are harmful to human health or the environment can leach from the product in which they are applied to the environment. Apart from the technical properties, the leaching characteristics determine whether the by-products can be used for the intended application.

The impact of co-incineration on by-product quality has been extensively investigated and reported in some countries, such as in the Netherlands. Given the high removal rates of the dust control techniques prevalent in large combustion plants, more than 99 % of the elements are found in the ashes. Generally, changes in the composition of the fuel will result in equivalent changes in the composition of the ashes. Depending on the volatility of the elements, redistribution may take place, resulting in different concentrations in the fly ash and in the bottom ash.

Co-incineration causes the ash composition to change correspondingly with the waste composition. The elemental composition of the by-products can be predicted to the extent that it is possible to determine the margins of which, when, and in which quantities waste can be co-incinerated.

Metals, to different degrees, present a risk of leaching into the environment after they have been exposed to water for a very long time. Leaching characteristics are less important for fly ash when it is used in immobilised applications in the cement and concrete industry.

Bottom ash, however, applied for example as a layer under a road, can leach some elements in the long term. A shift in micro-elemental composition and leaching may pose a constraint to the application of bottom ash from co-incineration.

Gypsum is hardly affected by changing the composition of the fuel. The leaching risk is small, as the product is applied principally inside buildings, where contact with water does not occur. Depending on quality requirements, gypsum may be regularly washed before it leaves the combustion plant.

Filter ashes from pretreatment processes such as gasification are generally more difficult to use and may have to be sent for disposal. Techniques to immobilise the microelements can open up possibilities for some uses though.

For an overall evaluation of the environmental impact of metal concentrations, the immobilisation and stabilisation of metals in the residue should be taken into account, as well as the calculation of the total content. The extent of immobilisation can be calculated from the metal concentrations in the eluate.

Table 9.5 and Table 9.6 show the effect of co-incineration on combustion residues, such as dry sorption residues and coarse ash, compared with regular fuel. It can be seen that the concentrations of Hg (by a factor of two), Pb (by a factor of three) and Cd (by a factor of four) are increased in the fly ash dry sorption residue. In the coarse ash, the concentrations of Pb, Zn, Cu and Cr are increased; however, the leaching behaviour is not notably influenced.

Table 9.5: Effect of co-incineration on combustion residues (dry sorption residue)

	Dry sorption residues			
	Total content (mg/kg)		Eluate content (mg/kg)	
	Coal	Co-firing of about 10 % sewage sludge	Coal	Co-firing of about 10 % sewage sludge
Al	2.9	3.4–3.6	12	8.5–11
As	34	31–37	< 0.2	< 0.2
Cd	< 2	4–7	< 0.1	< 0.1
Cr	49	55–64	0.91	0.81–0.85
Cu	135	80–140	< 0.1	< 0.1
Hg	0.6	0.6–1.3	< 0.01	< 0.01
Ni	91	93–100	< 0.2	< 0.2
Pb	230	228–650	< 0.3	< 0.3
Zn	140	245–570	< 0.2	< 0.2

Source: [145, UBA AT 2000]

Table 9.6: Effect of co-incineration on combustion residues (coarse ash)

	Coarse ash			
	Total content (mg/kg)		Eluate content (mg/kg)	
	Coal	Co-firing of about 10 % sewage sludge	Coal	Co-firing of about 10 % sewage sludge
Al	4.4	4.8–5.9	21	8.8–133
As	11	11–13	< 0.2	< 0.2
Cd	< 2	< 2	< 0.1	< 0.1
Cr	59	86–260	0.11	< 0.1–0.12
Cu	80	590–7 800	0.1	0.1–0.23
Hg	< 0.2	< 0.2	< 0.01	< 0.01
Ni	70	130–290	< 0.2	< 0.2
Pb	57	130–3 400	< 0.3	< 0.3–1.7
Zn	100	190–5 590	< 0.2	0.2–1.1

Source: [145, UBA AT 2000]

Table 9.5 and Table 9.6 show that the risk of mobilising the metals in the residue from co-firing is generally relatively low, due to the high temperatures in the boiler (vitrification effect), and due to the compact nature of the residue after humidification. As a consequence, no concentration increases in the eluate are detected, in particular when the residue has been stabilised.

9.3 Techniques to consider in the determination of BAT for waste co-incineration

This section describes techniques (or combinations thereof), and associated monitoring, considered to have the potential for achieving a high level of environmental protection in the activities within the scope of this document. The techniques described include both the technology used and the way in which the installations are designed, built, maintained, operated, and decommissioned.

It covers process-integrated and end-of-pipe techniques. Waste prevention and management, including waste minimisation and recycling procedures, are also considered.

Annex III to the Industrial Emissions Directive lists a number of criteria for determining BAT, and the information within this chapter addresses these considerations. As far as possible, the standard structure of Table 3.4 is used to outline the information on each technique, to enable a comparison of techniques and the assessment against the definition of BAT given in the Industrial Emissions Directive.

This section does not necessarily provide an exhaustive list of techniques that could be applied in the sector. Other techniques may exist, or may be developed, which could be considered for the determination of BAT for an individual installation.

In this section, the techniques to be considered have only been fully described when they are specific to the considered combusted fuel or applied combustion process (co-incineration of waste). Indeed, for most of the techniques, general descriptions are already presented in Chapter 3. Therefore, in order to avoid repetition, for those general techniques already described in Chapter 3, only the additional information that is specific to the co-incineration of waste is reported here in synthesis tables.

9.3.1 Techniques to control diffuse emissions and odours from the storage and handling of dusty and odorous waste

Table 9.7 summarises the general techniques to be considered in the determination of BAT for the storage and handling of waste to be co-incinerated.

Table 9.7: General techniques for the storage and handling of waste to be co-incinerated

Technique	Description	Achieved environmental benefits	Environmental performance and operational data	Cross-media effects	Technical considerations relevant to applicability
					New and existing plants
Transport and handling of waste					
Enclosed transfers	Transport of dusty and/or odorous waste, such as sludge in enclosed or covered containers	Reduction of odorous and fugitive emissions	High operational experience	None	Generally applicable
Enclosed unloading buildings	Unloading of dusty and/or odorous waste in enclosed unloading buildings, e.g. equipped with suction devices that lead odorous air directly to the combustion chamber or burner, where it can be used as combustion air	Reduction of odorous and fugitive emissions			
Enclosed waste storage	Storage of dusty and/or odorous waste in closed silos or bunkers	Reduction of odorous and fugitive emissions			
Treatment of air from sewage sludge storage	Application of suction plants and subsequent cleaning devices to silos, bunkers and hoppers storing sewage sludge. The odorous air can be led directly to the combustion chamber or burner, where it can be used as combustion air. Without suction plants, the risk of explosion due to high concentrations of methane might be high. The production of methane might especially occur inside the hopper for the mechanically dried sludge due to its high water content	Low emissions to the ambient air and low concentrations of methane inside the hoppers, thus reducing the risk of explosion			

9.3.2 Techniques for the pretreatment of waste

Table 9.8 summarises the general techniques to be considered in the determination of BAT for the pretreatment of waste.

Table 9.8: General techniques for the pretreatment of waste to be co-incinerated

Technique	Description	Achieved environmental benefit	Environmental performance and operational data	Cross-media effects	Technical considerations relevant to applicability		Driving force for implementation
					New plants	Existing plants	
Drying	See WT BREF	Maintains the good performance of the boiler	High operational experience	Additional energy is needed for drying. Although the high moisture content of the waste negatively affects the boiler performance, in some cases the cost and energy requirement of thermal drying make it more economical to fire mechanically dried sewage sludge with a high water content	Applicability may be limited by insufficient recoverable heat from the process, by the required combustion conditions, or by the waste moisture content		Waste with a high moisture content can be used once dried
Solar drying of sewage sludge	See WT BREF	Maintains the good performance of the boiler	High operational experience	Tendency to generate odorous emissions	Applicability may be limited by space availability		Reduction of overall energy requirement of the plant
Pyrolysis	Pretreatment by pyrolysis can ensure an adequate burnout in the boiler, due to the short residence time of the fuel in the furnace	The impact of the waste on the performance of the boiler is diminished	Limited operational experience	Additional energy is needed for the pyrolysis reactor	Generally applicable	Applicability may depend on the design of the main boiler	Pyrolysis can be an attractive option for waste that cannot be ground in a solid fuel mill to the required dimensions for co-combustion in a pulverised solid-fuel-fired combustion plant. A large variety of waste can be used

Anaerobic digestion	The waste needs to be biodegradable. The reactor operates at low temperatures with almost no corrosion. See also WT BREF	Methanisation of waste has several advantages, as the products are easily fitted into the boiler	High operational experience	NA	Generally applicable		A large variety of waste can be used. The technique is well suited for waste with a high water content
Gasification	See Chapter 4. See also WI BREF	NA	Limited operational experience	NA	Generally applicable	Applicability may depend on the design of the main boiler	Large quantities of waste with high concentrations of metals (e.g. Hg) can be co-combusted after gasification and cleaning of the syngas
<p>NB: NA: No relevant specific information available.</p>							

9.3.3 Techniques to introduce waste into the combustion process

Table 9.9 summarises the general techniques to be considered in the determination of BAT for the introduction of waste into the combustion process.

Table 9.9: General techniques to introduce waste into the combustion process

Technique	Description	Achieved environmental benefits	Environmental performance and operational data	Cross-media effects	Technical considerations relevant to applicability		Economics	Example plants
					New plants	Existing plants		
Mixing with the main fuel	A heterogeneous or poorly mixed fuel stream or an uneven distribution may influence the ignition and combustion in the boiler, and thus has to be prevented	Maintains stable combustion conditions	High operational experience	None	Mixing is only possible when the grinding behaviour of the main fuel and waste is more or less the same or when the amount of waste is very small compared to the main fuel flow		Plant-specific	Plants 121, 142
Feeding of main fuel and waste together	NA	Good performance of the fluidised bed boiler	NA	None	Generally applicable	Generally applicable	NA	NA
NB: NA: No relevant specific information available.								

9.3.4 Techniques to prevent and/or control emissions to air from waste co-incineration in LCPs

Techniques that have been considered in the determination of BAT within the fuel-specific chapters are to be considered when waste is co-incinerated. However, waste co-incineration can lead to the following effects:

- a change in the flue-gas volume and composition, with consequences for the heat transfer and flue-gas cleaning systems (e.g. deactivation of the SCR catalyst by As, P, F and alkali metals), and interference with FGD systems;
- good and even combustion conditions have to be enabled (including flame stability, flame temperature, formation of an oxidative atmosphere at the surfaces of the boiler, and prevention of the formation of ‘strands’);
- emissions to air (especially emissions of Hg, metals, dioxins and furans, HCl, HF, unburnt carbon, and CO) may be increased.

In addition to the aforementioned techniques, Table 9.10 and Table 9.11 summarise the general and more specific techniques to consider in the determination of BAT for the prevention and reduction of emissions to air from waste co-incineration in combustion plants.

More details on environmental performance and operational data related to emissions to air from European combustion plants co-incinerating waste and applying the techniques listed in these tables are given after the tables.

Table 9.10: General techniques for the prevention and control of emissions to air from waste co-incineration in combustion plants

Technique	Description	Achieved environmental benefits	Environmental performance and operational data	Technical considerations relevant to applicability	Economics
Dust					
ESP	See Section 3.2.2.1.1	Reduction of dust and metals	High operational experience	Generally applicable	Plant-specific
Bag filter	See Section 3.2.2.1.2	Reduction of dust and metals	High operational experience	Generally applicable	Plant-specific
SO_x					
Wet, semi-dry or dry FGD techniques	See Section 3.2.2.2	Reduction of SO _x , HCl, HF, dust and metals	High operational experience	See main fuel-specific chapters for further details on the applicability of each technique	Plant-specific
NO_x					
Combination of primary and/or secondary techniques	See Section 3.2.2.3	Reduction of NO _x	High operational experience	See main fuel-specific chapters for further details on the applicability of each technique	Plant-specific
Metals and others such as VOCs and dioxins					
Metal separator in the feeding line	See Section 3.2.2.5.5	Reduction of metals in air, water and residues	High operational experience	Generally applicable	Plant-specific
ESP or bag filter, wet, semi-dry or dry FGD techniques and, as an additional option, the injection of activated carbon and/or halogenated additives	See Section 3.2.2.5	Reduction of SO _x , HCl, HF, dust and metals (in particular Hg), as well as VOCs and dioxins	High operational experience	See main fuel-specific chapters for further details on the applicability of each technique	Plant-specific
Selective catalytic reduction (SCR)	SCR usually requires a bigger, multi-layer catalyst than for just the DeNO _x function. See also Section 3.2.2.3.11	Reduction of gaseous PCDD/F (not particulate-bound)	NA	See main fuel-specific chapters for further details on the applicability of each technique	NA
Wet scrubber	The wet scrubber enables the quick cooling of the flue-gases from their combustion temperature to below 100 °C, limiting the generation of dioxins when the flue-gas cools down. See also Section 3.2.2.1.4	Reduction of PCDD/F	NA	See main fuel-specific chapters for further details on the applicability of each technique	NA
NB: NA: No relevant specific information available.					

Table 9.11: Specific techniques for the prevention and control of emissions to air from waste co-incineration in combustion plants

Technique	Description	Achieved environmental benefits	Environmental performance and operational data	Cross-media effects	Technical considerations relevant to applicability		Economics	Driving force for implementation
					New plants	Existing plants		
Careful selection of the waste for co-incineration	Exact knowledge of waste's origin, physico-chemical parameters and hazardous potential. Wastes are analysed periodically to check their quality for co-incineration. The comprehensive analysis of waste on delivery can include: name and address of the deliverer, mass, owner and origin of the waste, water and ash content, calorific value, contents of chlorides, fluorides, sulphur and metals	Better knowledge of the waste helps to avoid unexpected peaks of pollutants and avoids damaging the boiler due to corrosion	High operational experience	None	Generally applicable	Generally applicable	Plant-specific	NA
Limitation of the percentage of waste that is co-incinerated	NA	Limitation of additional environmental impact	High operational experience	None		Generally applicable	Plant-specific	NA
Gasification	See Chapter 4. See also WI BREF	NA	Limited operational experience	NA		Applicability may depend on the design of the main boiler	Plant-specific	Large quantities of waste with high metal concentrations (including Hg) can be co-combusted after gasification and cleaning of the gas produced
NB: NA: No relevant specific information available.								

Environmental performance and operational data: emissions to air from combustion plants applying the general techniques listed in Table 9.10 and Table 9.11

Plants co-incinerating waste are globally divided into two groups, depending on the combustion fuel of reference:

1. Coal- and/or lignite-fired combustion plants co-incinerating waste

Based on data collected at plant level across the EU for 2010, achieved emission levels for NO_x, SO_x, HCl, HF, dust and mercury, as well as energy efficiencies of coal- and/or lignite-fired plants co-incinerating waste are reported in Section 5.1 together with the emissions of plants that fire the same main fuels without any co-incineration. In the following paragraphs, additional contextual information is presented, to highlight the possible influence of waste co-incineration on the achieved emission levels. As this BREF assesses energy efficiency based on design values, it is not possible to provide further relevant plant-level analysis to characterise the influence of waste co-incineration on energy efficiency. Additional graphs are presented for emissions of metals (Sb+As+Pb+Cr+Co+Cu+Mn+Ni+V, and Cd+Tl), TVOC and PCDD/F from coal- and/or lignite-fired plants including plants co-incinerating waste.

SO₂ emissions

Figure 5.32 shows SO₂ emission levels achieved in well-performing plants of more than 300 MW_{th} combusting coal and/or non-indigenous lignite. Of the plants shown in the graph, Plant 123 and Plant 662 burn 0.1 % and 0.2 % sewage sludge respectively; Plants 211 and 212 burn 2 % animal flour, 2 % residues of vegetable food processing and 2 % sawdust; Plant 146 burns 6 % liquid waste and 2 % solid waste; Plant 219 burns 2 % RDF; Plant 142 burns 4 % commercial and municipal solid waste. Of the indigenous lignite-fired plants of Figure 5.33, around half co-incinerate waste to a degree comprised between 2 % and 3 %. All these plants, like the other plants in the tables, are fitted with wet FGD systems and achieve SO₂ emission levels in the same range.

HCl and HF emissions

Figure 5.34 shows HCl emission levels achieved in well-performing coal- and/or lignite-fired plants of more than 100 MW_{th}. Table 9.12 summarises the degree of co-incineration in those plants, and their performance in terms of HCl emissions.

Table 9.12 shows that coal- and/or lignite-fired plants co-incinerating waste achieve annual average HCl emissions in the same range as plants that do not co-incinerate waste. However, waste co-incineration may be associated with peaks in the short-term emission levels, shown as the 'upper range' in the table. Plants 211V and 212V (420–435 MW_{th}), for instance, achieve yearly average HCl levels below 0.5 mg/Nm³, but with short-term peaks of 94 mg/Nm³ and 46 mg/Nm³. Both plants are PC boilers firing coal with an average chlorine content of 73 mg/kg and 6 % waste, averaging between around 1 000 mg/kg and 5 000 mg/kg of chlorine, which may explain the occurrence of HCl emission peaks. Plant 17V, the best performing plant reported, does not co-incinerate waste but burns coal with an average chlorine content of 60 mg/kg with a small share of biomass with about 950 mg/kg of chlorine.

Table 9.12: Co-incineration degree and achieved HCl emissions in well-performing coal- and/or lignite-fired plants of more than 100 MW_{th} (see Figure 5.34)

Plant code	Co-incineration degree (by thermal input)	HCl yearly average (mg/Nm ³)	HCl higher end of range ¹ (mg/Nm ³)	Plant code	Co-incineration degree (by thermal input)	HCl yearly average (mg/Nm ³)	HCl higher end of range ¹ (mg/Nm ³)
17V	-	0.12	38.7	77V	-	1.20	NA
221VC	-	0.23	0.3	441-1V	-	1.33	NA
23V	-	0.29	NA	367V	-	1.35	4.8
212V	6 %	0.30	94.0	117-1VC	3 %	1.35	3.4
415-2V	-	0.37	0.7	478-2	-	1.40	2.9
690	-	0.4	NA	25-1V	-	1.5	NA
415-1V	-	0.42	0.8	390-6V	-	1.56	NA
124bV C	-	0.50	0.7	390-1V	-	1.60	NA
211V	6 %	0.50	46.0	390-2V	-	1.67	NA
141V	-	0.50	NA	390-5V	-	1.92	NA
101V	-	0.52	NA	224V	-	1.97	NA
34V	-	0.57	NA	662V	0.20 %	2.00	3.0
146V	6 %	0.60	NA	286V	-	2.2	NA
213V	-	0.7	NA	132VC	-	2.17	NA
117-2VC	3 %	0.70	0.8	390-3V	-	2.19	NA
253V	-	0.76	1.0	197VC	-	2.23	3.6
128-3VC	2 %	0.80	1.2	478-1	-	2.27	2.3
128-4VC	2 %	0.80	1.2	442V	-	2.52	29.7
123VC	0.10 %	0.85	4.6	479V	-	2.88	NA
689	-	0.9	NA	131V	-	3.05	7.5
547V	-	0.89	1.1	390-4V	-	3.10	NA
121VC	1 %	1.00	NA	368V	-	3.20	23.0
128-1VC	3 %	1.00	1.7	198VC	-	3.24	4.3
127-2VC	2 %	1.00	1.7	441-2V	-	3.67	NA
128-2VC	3 %	1.00	1.7	391V	-	3.88	NA
127-1VC	2 %	1.00	1.7	219VC	2 %	4.20	23.8
69V	-	1.00	NA	388NV	-	4.46	NA
223V	-	1.15	NA	18-2V	-	4.77	NA

⁽¹⁾ The higher end of the range corresponds to the yearly maximum of hourly averages or maximum of the samples obtained over the year.

Source: [3, LCP TWG 2012]

Figure 5.35 shows HF emission levels achieved in well-performing coal- and/or lignite-fired plants of more than 100 MW_{th}. Table 9.17 summarises the degree of co-incineration in those plants, and their performance in terms of HF emissions. Although the same considerations as for HCl are in principle valid, in most cases the fluorine content of the waste burnt in the plants included in the table is not significantly higher than in the main fuel, and the achieved HF emission levels are similar in plants that do co-incinerate waste and in those that do not.

Table 9.13: Co-incineration degree and achieved annual average HF emissions in well-performing coal- and/or lignite-fired plants of more than 100 MW_{th} (see Figure 5.35)

Plant code	Co-incineration degree (by thermal input)	HF yearly average (mg/Nm ³)	HF higher end of range ¹ (mg/Nm ³)	Plant code	Co-incineration degree (by thermal input)	HF yearly average (mg/Nm ³)	HF higher end of range ¹ (mg/Nm ³)
662V	0.20 %	0.01	0.01	142VC	4 %	0.86	NA
253V	-	0.04	0.1	390-1V	-	0.94	NA
224V	-	0.06		221VC	-	0.95	1.3
123VC	-	0.07		1005V	-	1.00	NA
23V	-	0.10		1000V	-	1.0	NA
212V	6 %	0.10	4.1	415-1V	-	1.10	1.4
141V	-	0.10		415-2V	-	1.15	1.4
25-1V	-	0.1		18-2V	-	1.19	NA
34V	-	0.12		388NV	-	1.42	NA
17V	-	0.13	1.8	390-5V	-	1.54	NA
22_1V	-	0.1	0.1	390-4V	-	1.59	NA
146V	6 %	0.15		121VC	-	1.63	NA
197VC	-	0.22	0.9	479V	-	1.66	NA
213V	-	0.3		547V	-	1.85	1.9
211V	6 %	0.30	1.3	444V	-	1.90	9.6
390-3V	-	0.34		77V	-	2.10	NA
184V	-	0.39		441-1V	-	2.10	NA
286V	-	0.5		124fVC	-	2.10	2.5
367V	-	0.47		385V	-	2.25	NA
198VC	-	0.58	1.0	18-1V	-	2.48	NA
99V	-	0.58		368V	-	2.60	5.0
441-2V	-	0.67		390-2V	-	2.62	NA
124bVC	-	0.74	1.0	223V	-	2.80	NA

(¹) The higher end of the range corresponds to the yearly maximum of hourly averages or maximum of the samples obtained over the year.
Source: [3, LCP TWG 2012]

NO_x emissions

Figure 5.37 and Figure 5.38 show NO_x emission levels achieved in well-performing coal- and/or lignite-fired plants of more than 300 MW_{th}. Of the 24 plants shown in the two graphs combined, Plant 219 burns 2 % RDF; Plant 662 burns 0.2 % sewage sludge; and Plant 377 burns 8 % sludge. These plants are fitted with similar techniques to other plants in the figures and achieve similar NO_x emission levels.

Dust emissions

Figure 5.28 and Figure 5.29 show dust emission levels achieved in well-performing coal- and/or lignite-fired plants sized between 300 MW_{th} and 1 000 MW_{th} and above 1 000 MW_{th} respectively.

Of the 24 plants shown in Figure 5.28, Plant 219 burns 2 % RDF; Plant 662 burns 0.2 % sewage sludge; and Plant 146 burns around 9 % solid and liquid waste combined. Of the 34 plants shown in Figure 5.29, there are nine plants (127-2VC, 127-1 VC, 117-2VC, 117-1VC, 123VC, 142VC, 121VC, 128-4VC, 128-2VC) with a co-incineration degree between 0.1 % and 4 %. In the case of both figures, the co-incinerating plants are fitted with similar techniques to other plants in the figure and achieve similar dust emission levels.

Mercury emissions

Figure 5.30 and Figure 5.31 show mercury emission levels achieved in well-performing coal- and lignite-fired plants respectively.

Of the 52 plants shown in Figure 5.30, there are 12 plants (211V, 156V, 462V, 662V, 81V, 219VC, 212V, 121VC, 142VC, 123VC, 146V, 377V) with a co-incineration degree between 0.1 % and 37 %. None of the plants are fitted with dedicated techniques to remove mercury in addition to general techniques to remove NO_x, SO_x, dust and associated pollutants. The mercury emission levels achieved by the co-incinerating plants are in the same range as those of other plants, although in the majority of cases the data did not reveal how much of the mercury input is associated to the coal and to the waste.

Of the 23 plants shown in Figure 5.31, there are six plants (127-2VC, 127-1VC, 128-4VC, 128-1VC, 128-3VC, 128-2VC) with a waste co-incineration degree between 1.5 % and 3 %. None of the plants are fitted with dedicated techniques to remove mercury in addition to general techniques to remove SO_x, dust and associated pollutants. Although the mercury emission levels achieved by the co-incinerating plants are generally on the high side of the range shown in the figure, the levels reported are in the same range as those of similar plants that do not co-incinerate waste. This is the case, for instance, for Plants 129-1VC and 129-2VC, which are technically identical to Plants 128-1VC to 128-4VC (1525 MW_{th} pulverised lignite-fired DBB fitted with wet FGD and an ESP) but do not co-incinerate waste, and which report the same mercury emission levels.

Particle-bound metal emissions

Figure 9.3 and Figure 9.4 show metal emission levels achieved in well-performing coal- and/or lignite-fired combustion plants of > 300 MW_{th}. The reported plants are sized between 380 MW_{th} and 2 500 MW_{th}, operated between 4 300 h/yr and 8 700 h/yr, with an equivalent full load factor above 56 %. Two thirds of these plants (15 out of 22 in Figure 9.3 and 11 out of 17 in Figure 9.4) co-incinerate waste with degrees between 0.1 % and 6 % (LHV basis). In particular, Plants 128-1VC to 128-4VC co-incinerate between 2 % and 3 % solid waste with an average metal content of 1 400 mg/kg and achieve average emissions of Sb+As+Pb+Cr+Co+Cu+Mn+Ni+V below 0.04 mg/Nm³ as an average of samples over the year with low dispersion (below 0.05 mg/Nm³ as a yearly maximum). In other cases, waste co-incineration is shown to be associated with larger short-term variations, as in Plants 117-1V and 117-2V which co-incinerate 3 % sewage sludge with an average metal content of 1 900 mg/kg. Plants 211V and 212V also co-incinerate up to 6 % solid waste. All report Cd+Tl emissions below 0.006 mg/Nm³ as an average of samples over the year and below 0.0075 mg/Nm³ as a maximum.

All these plants were commissioned between 1965 and 2010 and monitor their metal emissions periodically (from twice a year to nine times a year, except Plant 146V which reported one measurement only). They have yearly average dust emission levels between 1 mg/Nm³ and 12 mg/Nm³.

Only a few well-performing coal- and/or lignite-fired plants sized below 300 MW_{th} reported a significant waste co-incineration degree. Among those, the maximum reported Cd+Tl emission level over the sampling period is around 0.011 mg/Nm³.

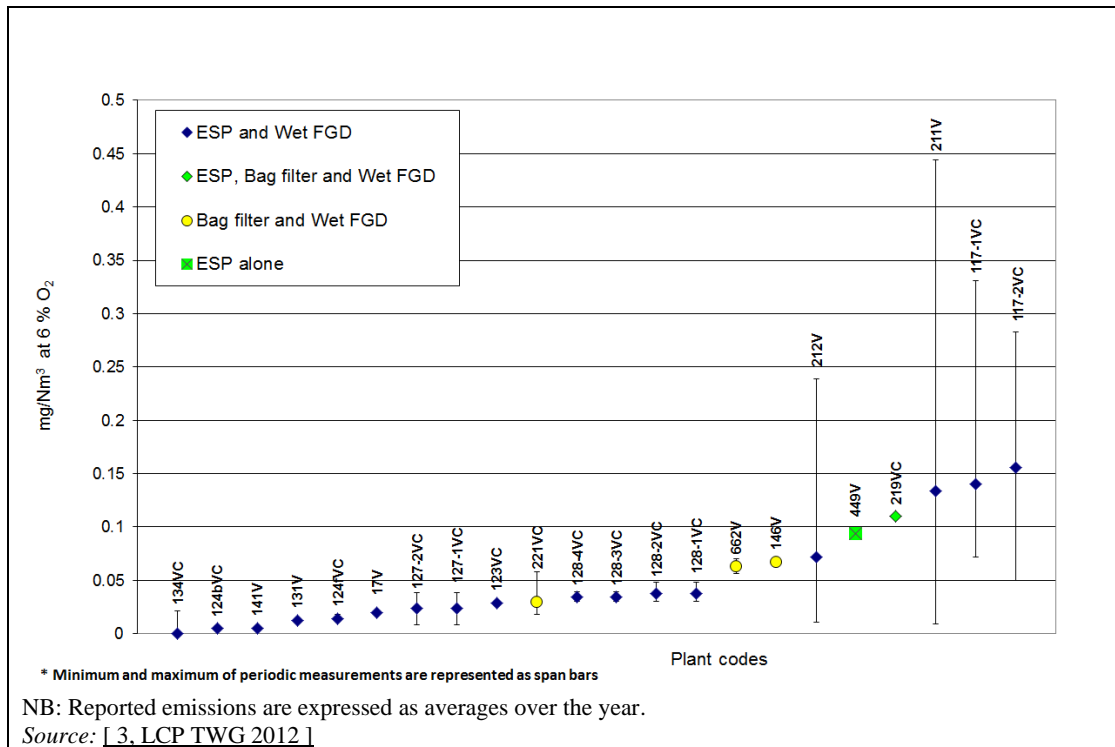

Figure 9.3: Sb+As+Pb+Cr+Co+Cu+Mn+Ni+V emissions from well-performing coal- and/or lignite-fired plants of more than 300 MW_{th}, including plants co-incinerating waste

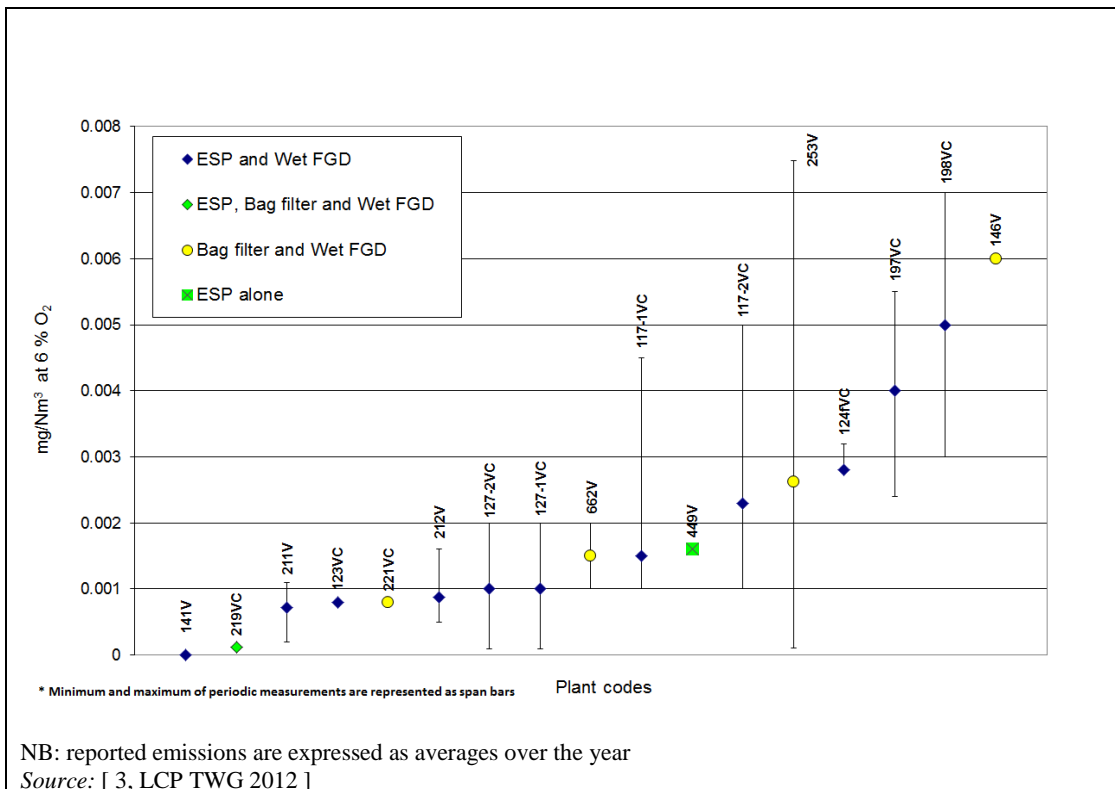

Figure 9.4: Cd+Tl emissions from well-performing coal- and lignite-fired plants of more than 300 MW_{th}, including plants co-incinerating waste (averages over the year)

TVOC emissions

Figure 9.5 shows TVOC emission levels achieved in well-performing coal- and/or lignite-fired combustion plants sized between 74 MW_{th} and 2 500 MW_{th}, operated between 4 000 h/yr and

8 700 h/yr, with an equivalent full load factor above 56 % with the exception of Plant 224V which reported an equivalent full load factor of 25 %. Half of these plants (16 out of 31) co-incinerate waste with degrees between 0.1 % and 37 % (LHV basis). All report TVOC emissions below 5 mg/Nm³ as a yearly average or average of samples over the year. In most cases, the short-term maxima achieved by these plants are well within 10 mg/Nm³. Plants 17V, 212V and 219VC report maxima above 10 mg/Nm³ and up to 17 mg/Nm³ as a maximum half-hourly average over the year. Of those, Plants 212V and 219 VC co-incinerate 6 % and 2 % waste respectively.

All these plants were commissioned between 1964 and 2006 and monitor their TVOC emissions continuously or periodically (from once a year to nine times a year).

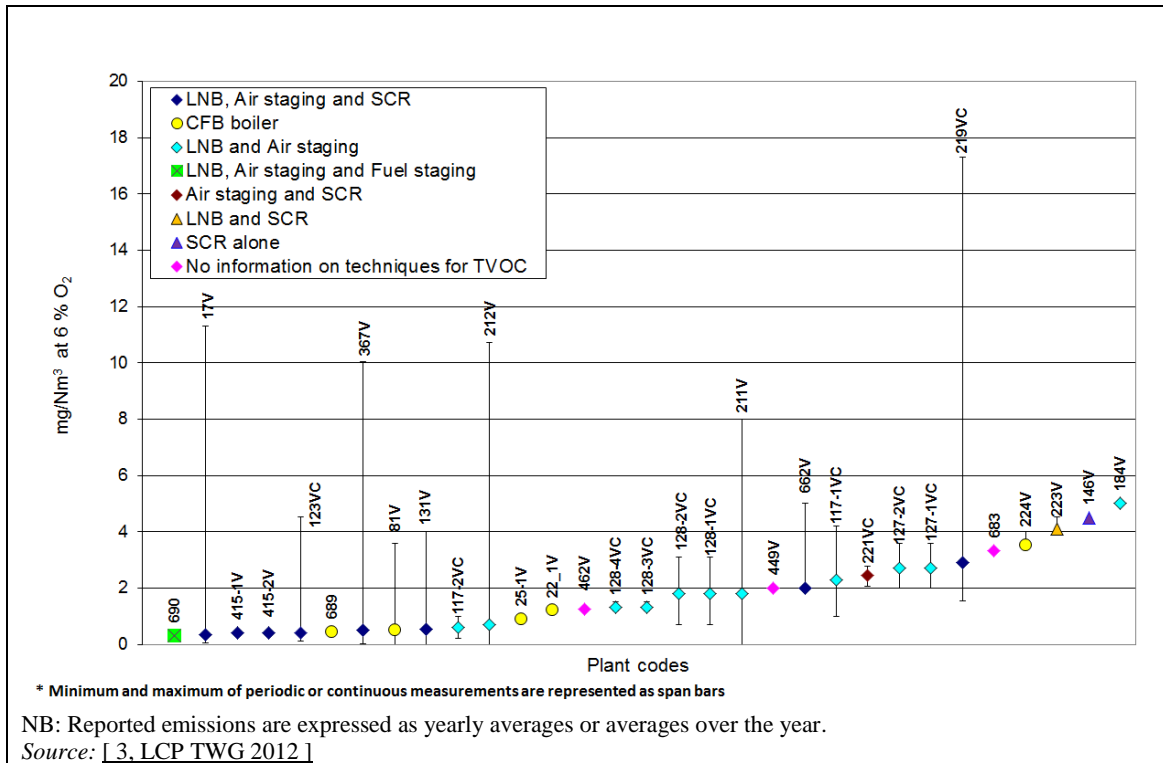

Figure 9.5: TVOC emissions from well-performing coal- and lignite-fired plants, including plants co-incinerating waste

PCDD/F emissions

Figure 9.6 shows PCCD/F emission levels achieved in well-performing coal- and/or lignite-fired combustion plants sized between 42 MW_{th} and 3 800 MW_{th}, operated between 2 000 h/yr and 8 700 h/yr, with an equivalent full load factor above 56 %. About half of these plants (16 out of 41) co-incinerate waste with degrees between 0.1 % and 37 % (LHV basis). All report PCDD/F emissions below 0.012 ng I-TEQ/Nm³ both as an average of samples over the year and as an average over the individual sampling period.

All these plants were commissioned between 1964 and 2006 and monitor their PCCD/F emissions periodically (from once a year to 11 times a year).

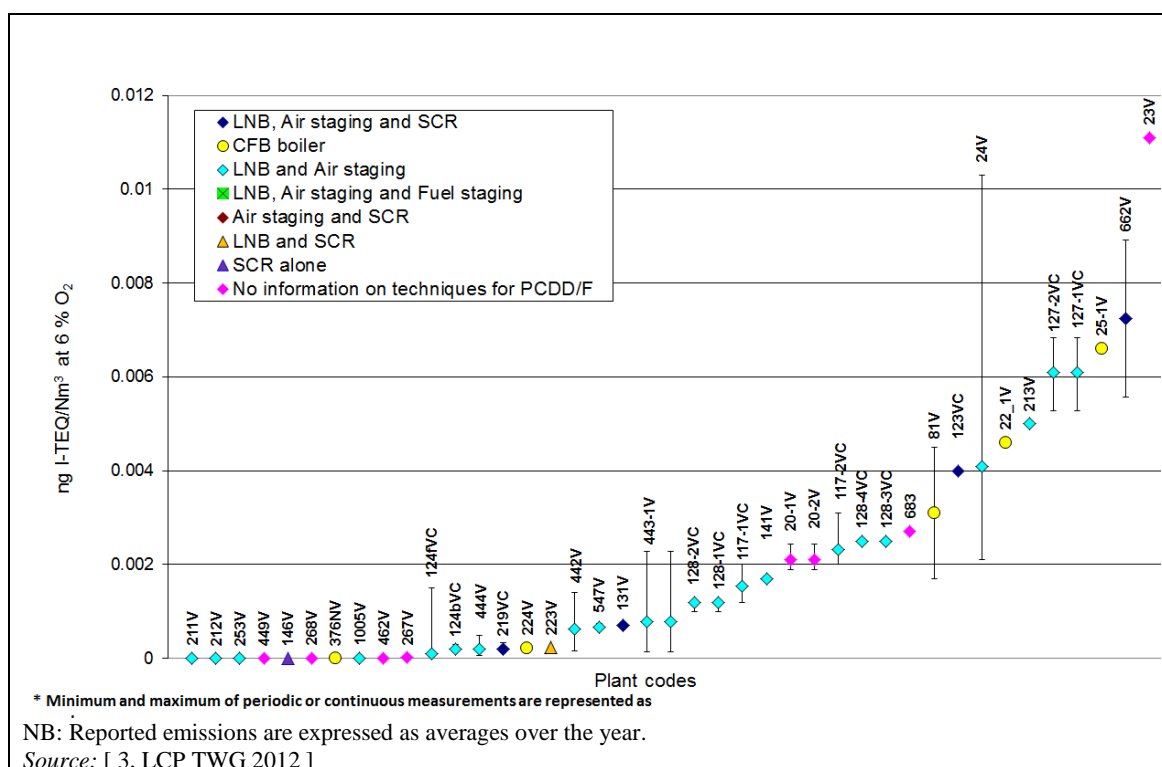

Figure 9.6: PCDD/F emissions from well-performing coal- and/or lignite-fired plants of more than 300 MW_{th}, including plants co-incinerating waste

2. Biomass- and/or peat-fired combustion plants co-incinerating waste

Based on data collected at plant level across the EU for 2010, achieved emission levels for NO_x, SO_x, HCl, HF, dust and mercury, as well as energy efficiencies of biomass- and/or peat-fired plants co-incinerating waste are reported in Section 5.2 together with the emissions of plants that fire the same main fuels without any co-incineration. In the following paragraphs, additional contextual information is presented, to highlight the possible influence of waste-co-incineration on the achieved emission levels. As this BREF assesses energy efficiency based on design values, it is not possible to provide further relevant plant-level analysis to characterise the influence of waste co-incineration on energy efficiency. Additional graphs are presented for emissions of metals (Sb+As+Pb+Cr+Co+Cu+Mn+Ni+V, and Cd+Tl), TVOC and PCDD/F from biomass- and/or peat-fired plants including plants co-incinerating waste.

SO₂ emissions

Figure 5.45 and Figure 5.46 show SO₂ emission levels achieved in well-performing biomass- and/or peat-fired plants of less than 100 MW_{th} and between 100 MW_{th} and 300 MW_{th} respectively. Around a third of the plants shown in both graphs burn waste to variable degrees (up to 100 % when including biomass waste), including Plants 671V, 464V, 672V, 470V, 108-1/2VC, 455V, 476V, 46V, 673V. All these plants are generally fitted with secondary techniques such as a FG condenser, wet FGD system, SDA, DSI or scrubbers, and achieve SO₂ emission levels in the same range as other plants not co-incinerating waste and that are often not fitted with specific techniques to control SO₂ emissions. Plant 476V combusts 20 % tyre waste with 1.6 % sulphur content and shows larger hourly variations than the other plants in Figure 5.46. None of the biomass- and/or peat-fired plants of more than 300 MW_{th} in Figure 5.47 co-incinerate waste.

HCl and HF emissions

Figure 5.51 and Figure 5.52 show HCl emission levels achieved in well-performing biomass- and/or peat-fired plants of less than 100 MW_{th} and between 100 MW_{th} and 300 MW_{th} respectively. Around a third of the plants shown in both graphs burn waste to variable degrees

(up to 100 % when including biomass waste), including Plants 672V, 470V, 464V, 489-3, 108-1/2VC, 667V, 476V. Generally, these plants are more often fitted with secondary abatement techniques targeting HCl than other plants shown in the same graphs, and achieve HCl emission levels in the same range as other plants that do not co-incinerate waste. None of the biomass- and/or peat-fired plants of more than 300 MW_{th} of [3, LCP TWG 2012] co-incinerate waste.

Figure 5.53 and Figure 5.54 show HF emission levels achieved in well-performing biomass- and/or peat-fired plants of less than 100 MW_{th} and between 100 and 300 MW_{th} respectively. Only a few of the plants shown in both graphs burn waste, including Plants 470V (burning 25 % solid waste of animal origin) and 46V (burning 8 % SRF). These plants are generally fitted with secondary abatement techniques and achieve yearly average HF emission levels in the same range as other plants that do not co-incinerate waste, albeit with relatively high short-term variations. None of the biomass- and/or peat-fired plants of more than 300 MW_{th} of [3, LCP TWG 2012] co-incinerate waste.

NO_x emissions

Figure 5.45 and Figure 5.46 show NO_x emission levels achieved in well-performing biomass- and/or peat-fired plants of less than 100 MW_{th} and between 100 MW_{th} and 300 MW_{th} respectively. Around a third of the plants shown in both graphs burn waste to variable degrees (up to 100 % when including biomass waste), including Plants 470, 464V, 672, 671, 655VC, 108-1VC, 455, 476V, 674, 667, 673, 678. The plants in these graphs are mostly fitted with primary techniques and/or SNCR, and while plants fitted with secondary abatement techniques mostly achieve lower emission levels than plants fitted with primary techniques only, no clear correlation can be derived between NO_x levels and the degree of waste co-incineration. None of the biomass- and/or peat-fired plants of more than 300 MW_{th} in Figure 5.47 co-incinerate waste.

Dust emissions

Figure 5.55 and Figure 5.56 show dust emission levels achieved in well-performing biomass- and/or peat-fired plants of less than 100 MW_{th} and between 100 and 300 MW_{th} respectively. Around a third of the plants shown in both graphs burn waste to variable degrees (up to 100 % when including biomass waste), including Plants 672, 671, 108-2VC, 489-3V, 464V, 655VC, 455, 667, 476V, 678, 46V. In the case of both graphs, the co-incinerating plants are fitted with similar techniques to other plants in the figures and achieve similar dust emission levels. None of the biomass- and/or peat-fired plants of more than 300 MW_{th} in Figure 5.57 co-incinerate waste.

Mercury emissions

Figure 5.58 shows mercury emission levels achieved in well-performing biomass- and/or peat-fired plants. Around half of the 22 plants shown (46V, 476V, 464V, 655VC, 667, 470V, 671, 455V, 672) co-incinerate waste with degrees up to 100 % when including biomass waste. A third of these plants (46V, 655VC, 470V) are fitted with activated carbon injection together with a bag filter. Most of these plants monitor their emissions periodically (from once a year to 16 times a year), with three plants monitoring mercury continuously. All achieve mercury emission levels within 4 µg/Nm³ as an average of samples over the year or a yearly average, and within 5 µg/Nm³ as an average over the sampling period or as a 95th percentile of short-term averages in the case of continuous monitoring.

Particle-bound metal emissions

Figure 5.55 and Figure 5.56 show metal emissions levels achieved in well-performing biomass- and/or peat-fired combustion plants sized between 50 MW_{th} and 365 MW_{th}, operated between 4 600 h/yr and 8 500 h/yr, with an equivalent full load factor above 44 %. A third of these plants (Plants 667, 671, 476V, 489-3V, 455V, 72V, 655VC, 470V) co-incinerate waste with degrees between 2 % and 100 % when including biomass waste.

All these plants report Sb+As+Pb+Cr+Co+Cu+Mn+Ni+V emissions below 0.3 mg/Nm³ and Cd+Tl emissions below 0.003 mg/Nm³ as an average of samples over the year. Regarding emission variations, some of the plants co-incinerating waste show yearly maxima, either of

Sb+As+Pb+Cr+Co+Cu+Mn+Ni+V or of Cd+Tl, several times higher than their average. This is the case, for instance, for Plant 455V which co-incinerates 8 % reclaimed wood with a metal content around 600 mg/kg, and 489-3V which co-incinerates 55 % solid waste.

All these plants monitor their metal emissions periodically (from once a year to 16 times a year).

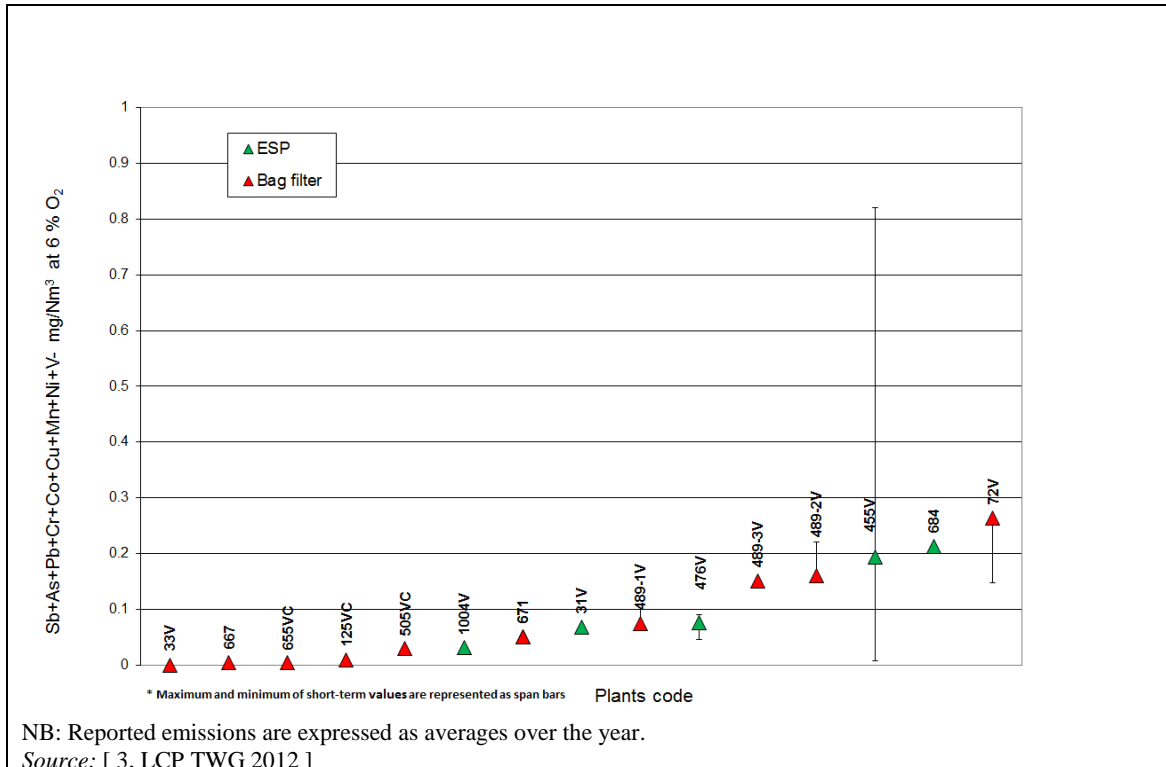

Figure 9.7: Sb+As+Pb+Cr+Co+Cu+Mn+Ni+V emissions from well-performing biomass- and/or peat-fired plants, including plants co-incinerating waste

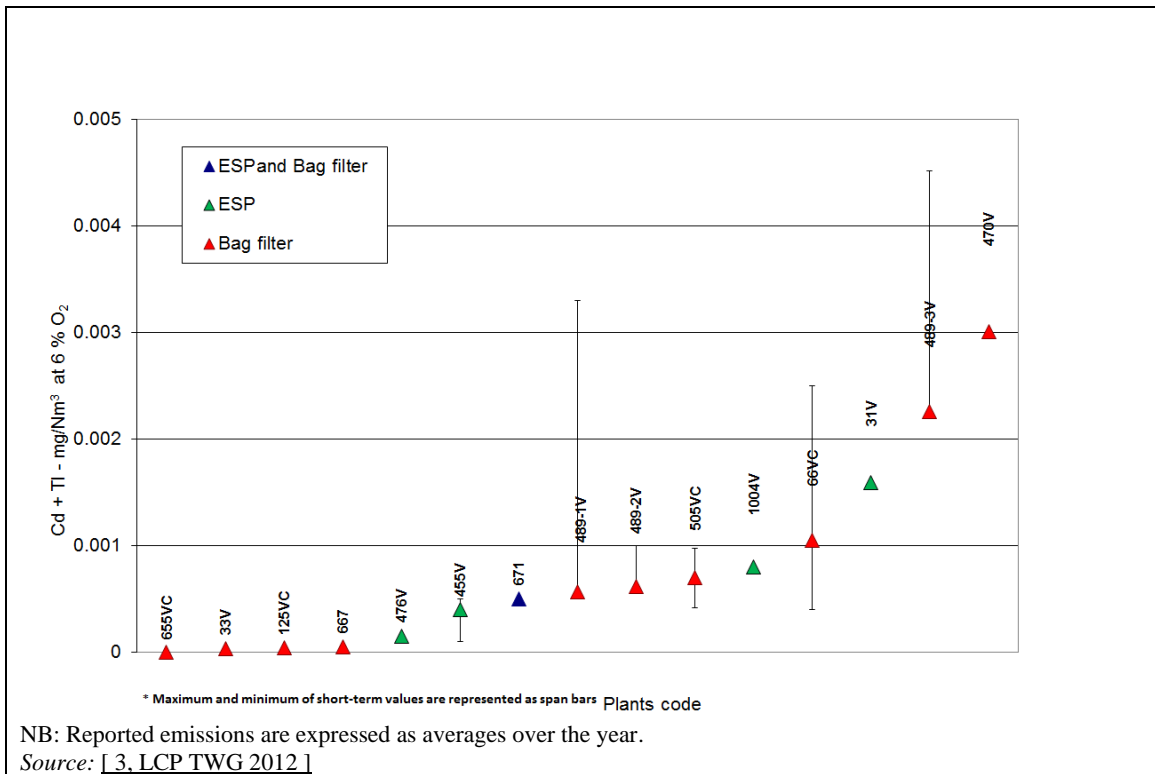

Figure 9.8: Cd+Tl emissions from well-performing biomass- and/or peat-fired plants, including plants co-incinerating waste

TVOC emissions

Figure 9.5 shows TVOC emission levels achieved in well-performing biomass- and/or peat-fired combustion plants sized between 50 MW_{th} and 200 MW_{th}, operated between 4 600 h/yr and 8 500 h/yr, with an equivalent full load factor above 44 %. Out of 18 of these plants, 8 (Plants 455V, 671, 108-1/2VC, 489-3V, 672, 667, 470V) co-incinerate waste with degrees between 2 % and 100 % when including biomass waste. All report TVOC emissions below 5 mg/Nm³ as a yearly average. In most cases, the short-term maxima achieved by these plants are well within 10 mg/Nm³. All these plants monitor their TVOC emissions continuously.

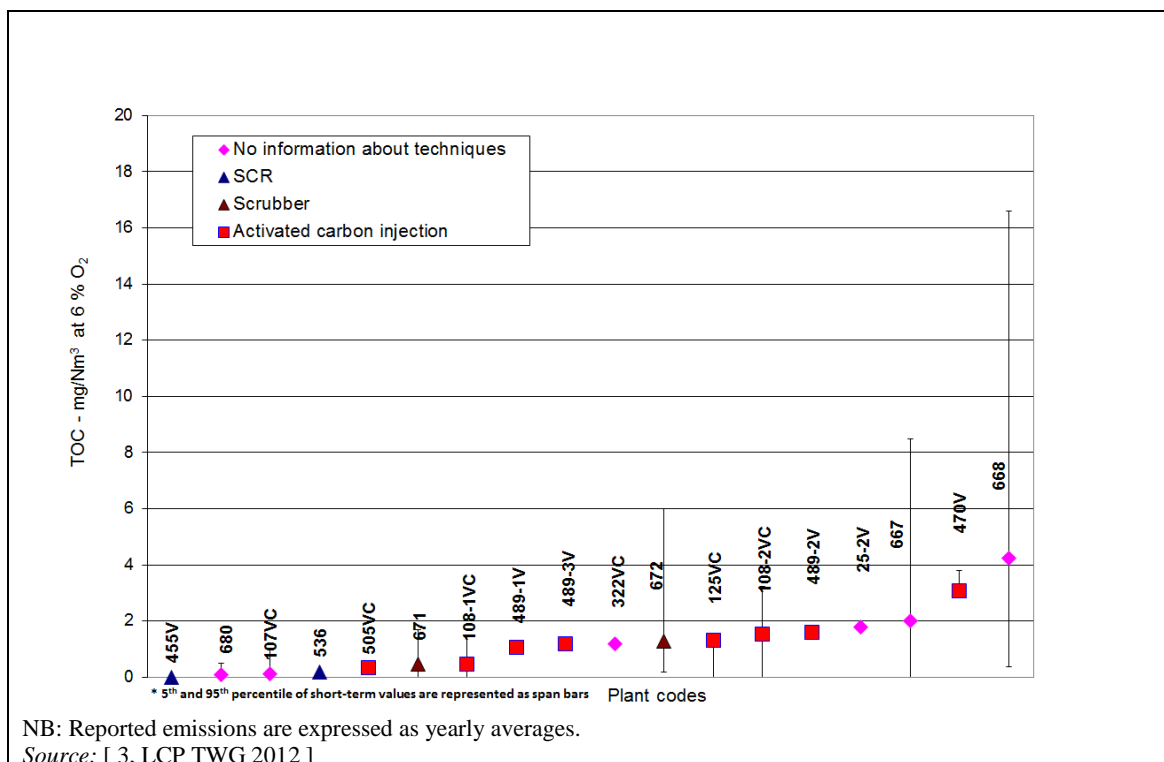

Figure 9.9: TVOC emissions from well-performing biomass- and/or peat-fired plants, including plants co-incinerating waste

PCDD/F emissions

Figure 9.10 shows PCCD/F emission levels achieved in well-performing biomass- and/or peat-fired combustion plants sized between 50 MW_{th} and 400 MW_{th}, operated between 5 700 h/yr and 8 500 h/yr, with an equivalent full load factor above 44 %. Out of those 15 plants, 9 (Plants 476V, 72V, 667, 46V, 470V, 455V, 671, 489-3V, 464V) co-incinerate waste with degrees between 2 % and 100 % when including biomass waste. All report PCDD/F emissions below 0.03 ng I-TEQ/Nm³ both as an average of samples over the year and as an average over the individual sampling period.

All these plants monitor their PCCD/F emissions periodically (from once a year to five times a year).

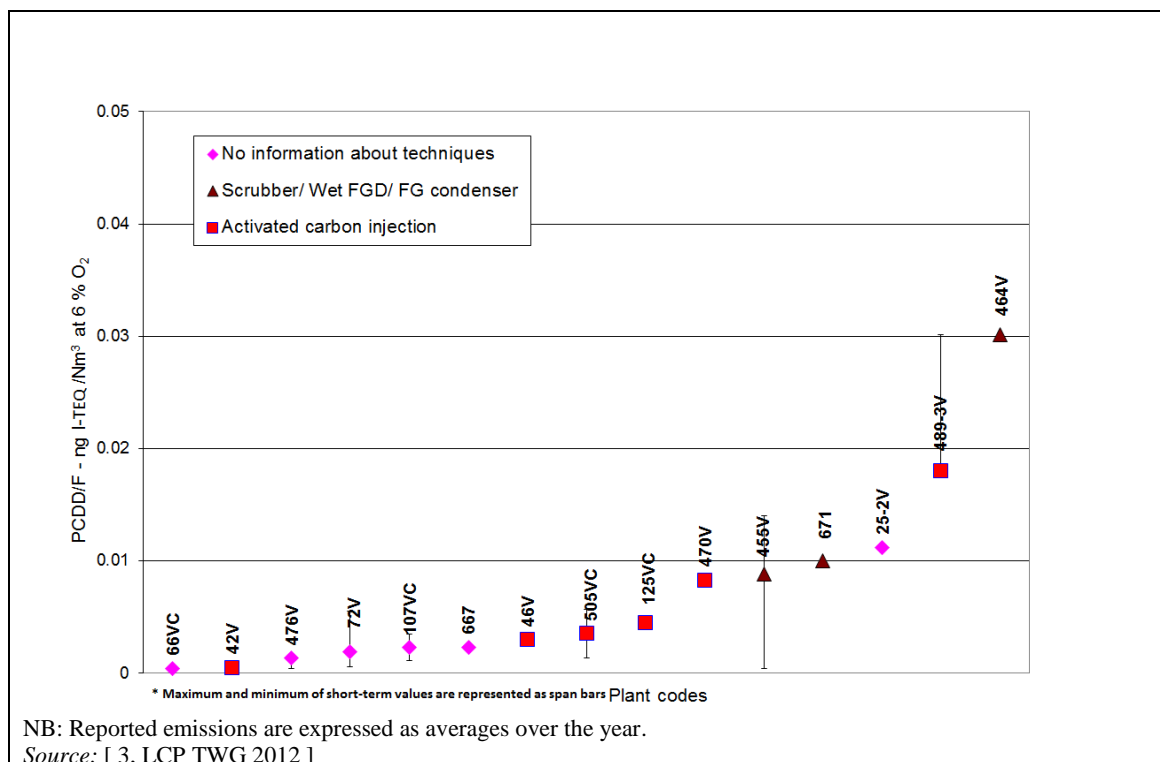

Figure 9.10: PCDD/F emissions from well-performing biomass- and/or peat-fired plants, including plants co-incinerating waste

9.3.5 Techniques to reduce the impact of waste co-incineration on the residues generated

Table 9.14 summarises the general techniques to be considered in the determination of BAT for minimising the impact of waste co-incineration on the residues generated.

Table 9.14: General techniques to reduce the impact of waste co-incineration on the residues generated

Technique	Description	Achieved environmental benefits	Environmental performance and operational data	Technical considerations relevant to applicability
				New and existing plants
Waste pretreatment	Maintain the quality of gypsum, ashes and slag at the same level as that occurring without waste co-incineration	Limit the impact of waste co-incineration on possible valorisation of residues	High operational experience	Generally applicable
Limitation of the amount of waste to be co-incinerated				
Combustion process adaptation to the co-incinerated waste				
Careful handling and transport of fly and bottom ashes	Careful handling and transport of fly and bottom ashes produced by the process and disposed of to land on or off site	Prevention of spillage, dust release or the generation of odours	High operational experience	Generally applicable

10 BEST AVAILABLE TECHNIQUES (BAT) CONCLUSIONS

Scope

These BAT conclusions concern the following activities specified in Annex I to Directive 2010/75/EU:

- 1.1: Combustion of fuels in installations with a total rated thermal input of 50 MW or more, only when this activity takes place in combustion plants with a total rated thermal input of 50 MW or more.
- 1.4: Gasification of coal or other fuels in installations with a total rated thermal input of 20 MW or more, only when this activity is directly associated to a combustion plant.
- 5.2: Disposal or recovery of waste in waste co-incineration plants for non-hazardous waste with a capacity exceeding 3 tonnes per hour or for hazardous waste with a capacity exceeding 10 tonnes per day, only when this activity takes place in combustion plants covered under 1.1 above.

In particular, these BAT conclusions cover upstream and downstream activities directly associated with the aforementioned activities including the emission prevention and control techniques applied.

The fuels considered in these BAT conclusions are any solid, liquid and/or gaseous combustible material including:

- solid fuels (e.g. coal, lignite, peat);
- biomass (as defined in Article 3(31) of Directive 2010/75/EU);
- liquid fuels (e.g. heavy fuel oil and gas oil);
- gaseous fuels (e.g. natural gas, hydrogen-containing gas and syngas);
- industry-specific fuels (e.g. by-products from the chemical and iron and steel industries);
- waste except mixed municipal waste as defined in Article 3(39) and except other waste listed in Article 42(2)(a)(ii) and (iii) of Directive 2010/75/EU.

These BAT conclusions do not address the following:

- combustion of fuels in units with a rated thermal input of less than 15 MW;
- combustion plants benefitting from the limited life time or district heating derogation as set out in Articles 33 and 35 of Directive 2010/75/EU, until the derogations set in their permits expire, for what concerns the BAT-AELs for the pollutants covered by the derogation, as well as for other pollutants whose emissions would have been reduced by the technical measures obviated by the derogation;
- gasification of fuels, when not directly associated to the combustion of the resulting syngas;
- gasification of fuels and subsequent combustion of syngas when directly associated to the refining of mineral oil and gas;
- the upstream and downstream activities not directly associated to combustion or gasification activities;
- combustion in process furnaces or heaters;

- combustion in post-combustion plants;
- flaring;
- combustion in recovery boilers and total reduced sulphur burners within installations for the production of pulp and paper, as this is covered by the BAT conclusions for the production of pulp, paper and board;
- combustion of refinery fuels at the refinery site, as this is covered by the BAT conclusions for the refining of mineral oil and gas;
- disposal or recovery of waste in:
 - waste incineration plants (as defined in Article 3(40) of Directive 2010/75/EU),
 - waste co-incineration plants where more than 40 % of the resulting heat release comes from hazardous waste,
 - waste co-incineration plants combusting only wastes, except if these wastes are composed at least partially of biomass as defined in Article 3(31) (b) of Directive 2010/75/EU,
 - as this is covered by the BAT conclusions for waste incineration.

Other BAT conclusions and reference documents that could be relevant for the activities covered by these BAT conclusions are the following:

- Common Waste Water and Waste Gas Treatment/Management Systems in the Chemical Sector (CWW);
- Chemical BREF series (LVOC, etc.);
- Economics and Cross-Media Effects (ECM);
- Emissions from Storage (EFS);
- Energy Efficiency (ENE);
- Industrial Cooling Systems (ICS);
- Iron and Steel Production (IS);
- Monitoring of Emissions to Air and Water from IED installations (ROM);
- Production of Pulp, Paper and Board (PP);
- Refining of Mineral Oil and Gas (REF);
- Waste Incineration (WI);
- Waste Treatment (WT).

Definitions

For the purposes of these BAT conclusions, the following **definitions** apply:

Term used	Definition
General terms	
Boiler	Any combustion plant with the exception of engines, gas turbines, and process furnaces or heaters
Combined-cycle gas turbine (CCGT)	A CCGT is a combustion plant where two thermodynamic cycles are used (i.e. Brayton and Rankine cycles). In a CCGT, heat from the flue-gas of a gas turbine (operating according to the Brayton cycle to produce electricity) is converted to useful energy in a heat recovery steam generator (HRSG), where it is used to generate steam, which then expands in a steam turbine (operating according to the Rankine cycle to produce additional electricity). For the purpose of these BAT conclusions, a CCGT includes configurations both with and without supplementary firing of the HRSG
Combustion plant	Any technical apparatus in which fuels are oxidised in order to use the heat thus generated. For the purposes of these BAT conclusions, a combination formed of: <ul style="list-style-type: none"> • two or more separate combustion plants where the flue-gases are discharged through a common stack, or • separate combustion plants that have been granted a permit for the first time on or after 1 July 1987, or for which the operators have submitted a complete application for a permit on or after that date, which are installed in such a way that, taking technical and economic factors into account, their flue-gases could, in the judgment of the competent authority, be discharged through a common stack is considered as a single combustion plant. For calculating the total rated thermal input of such a combination, the capacities of all individual combustion plants concerned, which have a rated thermal input of at least 15 MW, shall be added together
Combustion unit	Individual combustion plant
Continuous measurement	Measurement using an automated measuring system permanently installed on site
Direct discharge	Discharge (to a receiving water body) at the point where the emission leaves the installation without further downstream treatment
Flue-gas desulphurisation (FGD) system	System composed of one or a combination of abatement technique(s) whose purpose is to reduce the level of SO _x emitted by a combustion plant
Flue-gas desulphurisation (FGD) system - existing	A flue-gas desulphurisation (FGD) system that is not a new FGD system
Flue-gas desulphurisation (FGD) system - new	Either a flue-gas desulphurisation (FGD) system in a new plant or a FGD system that includes at least one abatement technique introduced or completely replaced in an existing plant following the publication of these BAT conclusions
Gas oil	Any petroleum-derived liquid fuel falling within CN code 2710 19 25, 2710 19 29, 2710 19 47, 2710 19 48, 2710 20 17 or 2710 20 19. Or any petroleum-derived liquid fuel of which less than 65 vol-% (including losses) distils at 250 °C and of which at least 85 vol-% (including losses) distils at 350 °C by the ASTM D86 method
Heavy fuel oil (HFO)	Any petroleum-derived liquid fuel falling within CN code 2710 19 51 to 2710 19 68, 2710 20 31, 2710 20 35, 2710 20 39. Or any petroleum-derived liquid fuel, other than gas oil, which, by reason of its distillation limits, falls within the category of heavy oils intended for use as fuel and of which less than 65 vol-% (including losses) distils at 250 °C by the ASTM D86 method. If the distillation cannot be determined by the ASTM D86 method, the petroleum product is also categorised as a heavy fuel oil

Net electrical efficiency (combustion unit and IGCC)	Ratio between the net electrical output (electricity produced on the high-voltage side of the main transformer minus the imported energy – e.g. for auxiliary systems' consumption) and the fuel/feedstock energy input (as the fuel/feedstock lower heating value) at the combustion unit boundary over a given period of time
Net mechanical energy efficiency	Ratio between the mechanical power at load coupling and the thermal power supplied by the fuel
Net total fuel utilisation (combustion unit and IGCC)	Ratio between the net produced energy (electricity, hot water, steam, mechanical energy produced minus the imported electrical and/or thermal energy (e.g. for auxiliary systems' consumption)) and the fuel energy input (as the fuel lower heating value) at the combustion unit boundary over a given period of time
Net total fuel utilisation (gasification unit)	Ratio between the net produced energy (electricity, hot water, steam, mechanical energy produced, and syngas (as the syngas lower heating value) minus the imported electrical and/or thermal energy (e.g. for auxiliary systems' consumption)) and the fuel/feedstock energy input (as the fuel/feedstock lower heating value) at the gasification unit boundary over a given period of time
Operated hours	The time, expressed in hours, during which a combustion plant, in whole or in part, is operated and is discharging emissions to air, excluding start-up and shutdown periods
Periodic measurement	Determination of a measurand (a particular quantity subject to measurement) at specified time intervals
Plant - existing	A combustion plant that is not a new plant
Plant - new	A combustion plant first permitted at the installation following the publication of these BAT conclusions or a complete replacement of a combustion plant on the existing foundations following the publication of these BAT conclusions
Post-combustion plant	System designed to purify the flue-gases by combustion which is not operated as an independent combustion plant, such as a thermal oxidiser (i.e. tail gas incinerator), used for the removal of the pollutant(s) (e.g. VOC) content from the flue-gas with or without the recovery of the heat generated therein. Staged combustion techniques, where each combustion stage is confined within a separate chamber, which may have distinct combustion process characteristics (e.g. fuel to air ratio, temperature profile), are considered integrated in the combustion process and are not considered post-combustion plants. Similarly, when gases generated in a process heater/furnace or in another combustion process are subsequently oxidised in a distinct combustion plant to recover their energetic value (with or without the use of auxiliary fuel) to produce electricity, steam, hot water/oil or mechanical energy, the latter plant is not considered a post-combustion plant
Predictive emissions monitoring system (PEMS)	System used to determine the emissions concentration of a pollutant from an emission source on a continuous basis, based on its relationship with a number of characteristic continuously monitored process parameters (e.g. the fuel gas consumption, the air to fuel ratio) and fuel or feed quality data (e.g. the sulphur content)
Process fuels from the chemical industry	Gaseous and/or liquid by-products generated by the (petro-)chemical industry and used as non-commercial fuels in combustion plants
Process furnaces or heaters	<p>Process furnaces or heaters are:</p> <ul style="list-style-type: none"> • combustion plants whose flue-gases are used for the thermal treatment of objects or feed material through a direct contact heating mechanism (e.g. cement and lime kiln, glass furnace, asphalt kiln, drying process, reactor used in the (petro-)chemical industry, ferrous metal processing furnaces), or • combustion plants whose radiant and/or conductive heat is transferred to objects or feed material through a solid wall without using an intermediary heat transfer fluid (e.g. coke battery furnace, cowper, furnace or reactor heating a process stream used in the (petro-)chemical industry such as a steam cracker furnace, process heater used for the regasification of liquefied natural gas (LNG) in LNG terminals). <p>As a consequence of the application of good energy recovery practices, process</p>

	heaters/furnaces may have an associated steam/electricity generation system. This is considered to be an integral design feature of the process heater/furnace that cannot be considered in isolation
Refinery fuels	Solid, liquid or gaseous combustible material from the distillation and conversion steps of the refining of crude oil. Examples are refinery fuel gas (RFG), syngas, refinery oils, and pet coke
Residues	Substances or objects generated by the activities covered by the scope of this document, as waste or by-products
Start-up and shut-down period	The time period of plant operation as determined pursuant to the provisions of Commission Implementing Decision 2012/249/EU of 7 May 2012, concerning the determination of start-up and shut-down periods for the purposes of Directive 2010/75/EU of the European Parliament and the Council on industrial emissions
Unit - existing	A combustion unit that is not a new unit
Unit- new	A combustion unit first permitted at the combustion plant following the publication of these BAT conclusions or a complete replacement of a combustion unit on the existing foundations of the combustion plant following the publication of these BAT conclusions
Valid (hourly average)	An hourly average is considered valid when there is no maintenance or malfunction of the automated measuring system

Term used	Definition
Pollutants / parameters	
As	The sum of arsenic and its compounds, expressed as As
C ₃	Hydrocarbons having a carbon number equal to three
C ₄₊	Hydrocarbons having a carbon number of four or greater
Cd	The sum of cadmium and its compounds, expressed as Cd
Cd+Tl	The sum of cadmium, thallium and their compounds, expressed as Cd+Tl
CH ₄	Methane
CO	Carbon monoxide
COD	Chemical oxygen demand. Amount of oxygen needed for the total oxidation of the organic matter to carbon dioxide
COS	Carbonyl sulphide
Cr	The sum of chromium and its compounds, expressed as Cr
Cu	The sum of copper and its compounds, expressed as Cu
Dust	Total particulate matter (in air)
Fluoride	Dissolved fluoride, expressed as F ⁻
H ₂ S	Hydrogen sulphide
HCl	All inorganic gaseous chlorine compounds, expressed as HCl
HCN	Hydrogen cyanide
HF	All inorganic gaseous fluorine compounds, expressed as HF
Hg	The sum of mercury and its compounds, expressed as Hg
N ₂ O	Dinitrogen monoxide (nitrous oxide)
NH ₃	Ammonia
Ni	The sum of nickel and its compounds, expressed as Ni
NO _x	The sum of nitrogen monoxide (NO) and nitrogen dioxide (NO ₂), expressed as NO ₂
Pb	The sum of lead and its compounds, expressed as Pb
PCDD/F	Polychlorinated dibenzo- <i>p</i> -dioxins and -furans
RCG	Raw concentration in the flue-gas. Concentration of SO ₂ in the raw flue-gas as a yearly average (under the standard conditions given under General considerations) at the inlet of the SO _x abatement system, expressed at a reference oxygen content of 6 vol-% O ₂
Sb+As+Pb+Cr+Co+Cu+Mn+Ni+V	The sum of antimony, arsenic, lead, chromium, cobalt, copper, manganese, nickel, vanadium and their compounds, expressed as Sb+As+Pb+Cr+Co+Cu+Mn+Ni+V
SO ₂	Sulphur dioxide
SO ₃	Sulphur trioxide
SO _x	The sum of sulphur dioxide (SO ₂) and sulphur trioxide (SO ₃), expressed as SO ₂
Sulphate	Dissolved sulphate, expressed as SO ₄ ²⁻
Sulphide, easily released	The sum of dissolved sulphide and of those undissolved sulphides that are easily released upon acidification, expressed as S ²⁻
Sulphite	Dissolved sulphite, expressed as SO ₃ ²⁻
TOC	Total organic carbon, expressed as C (in water)
TSS	Total suspended solids. Mass concentration of all suspended solids (in water), measured via filtration through glass fibre filters and gravimetry
TVOC	Total volatile organic carbon, expressed as C (in air)
Zn	The sum of zinc and its compounds, expressed as Zn

Acronyms

For the purposes of these BAT conclusions, the following **acronyms** apply:

Acronym	Definition
ASU	Air supply unit
CCGT	Combined-cycle gas turbine, with or without supplementary firing
CFB	Circulating fluidised bed
CHP	Combined heat and power
COG	Coke oven gas
COS	Carbonyl sulphide
DLN	Dry low-NO _x burners
DSI	Duct sorbent injection
ESP	Electrostatic precipitator
FBC	Fluidised bed combustion
FGD	Flue-gas desulphurisation
HFO	Heavy fuel oil
HRS	Heat recovery steam generator
IGCC	Integrated gasification combined cycle
LHV	Lower heating value
LNB	Low-NO _x burners
LNG	Liquefied natural gas
OCGT	Open-cycle gas turbine
OTNOC	Other than normal operating conditions
PC	Pulverised combustion
PEMS	Predictive emissions monitoring system
SCR	Selective catalytic reduction
SDA	Spray dry absorber
SNCR	Selective non-catalytic reduction

General considerations

Best Available Techniques

The techniques listed and described in these BAT conclusions are neither prescriptive nor exhaustive. Other techniques may be used that ensure at least an equivalent level of environmental protection.

Unless otherwise stated, these BAT conclusions are generally applicable.

Emission levels associated with the best available techniques (BAT-AELs)

Where emission levels associated with the best available techniques (BAT-AELs) are given for different averaging periods, all of those BAT-AELs have to be complied with.

The BAT-AELs set out in these BAT conclusions may not apply to liquid-fuel-fired and gas-fired turbines and engines for emergency use operated less than 500 h/yr, when such emergency use is not compatible with meeting the BAT-AELs.

BAT-AELs for emissions to air

Emission levels associated with the best available techniques (BAT-AELs) for emissions to air given in these BAT conclusions refer to concentrations, expressed as mass of emitted substance per volume of flue-gas under the following standard conditions: dry gas at a temperature of 273.15 K, and a pressure of 101.3 kPa, and expressed in the units mg/Nm³, µg/Nm³ or ng I-TEQ/Nm³.

The monitoring associated with the BAT-AELs for emissions to air is given in BAT 4

Reference conditions for oxygen used to express BAT-AELs in this document are shown in the table given below.

Activity	Reference oxygen level (O _R)
Combustion of solid fuels	6 vol-%
Combustion of solid fuels in combination with liquid and/or gaseous fuels	
Waste co-incineration	
Combustion of liquid and/or gaseous fuels when not taking place in a gas turbine or an engine	3 vol-%
Combustion of liquid and/or gaseous fuels when taking place in a gas turbine or an engine	15 vol-%
Combustion in IGCC plants	

The equation for calculating the emission concentration at the reference oxygen level is:

$$E_R = \frac{21 - O_R}{21 - O_M} \times E_M$$

Where:

- E_R: emission concentration at the reference oxygen level O_R;
- O_R: reference oxygen level in vol-%;
- E_M: measured emission concentration;

O_M : measured oxygen level in vol-%.

For averaging periods, the following **definitions** apply:

Averaging period	Definition
Daily average	Average over a period of 24 hours of valid hourly averages obtained by continuous measurements
Yearly average	Average over a period of one year of valid hourly averages obtained by continuous measurements
Average over the sampling period	Average value of three consecutive measurements of at least 30 minutes each ⁽¹⁾
Average of samples obtained during one year	Average of the values obtained during one year of the periodic measurements taken with the monitoring frequency set for each parameter
⁽¹⁾ For any parameter where, due to sampling or analytical limitations, 30-minute measurement is inappropriate, a suitable sampling period is employed. For PCDD/F, a sampling period of 6 to 8 hours is used.	

BAT-AELs for emissions to water

Emission levels associated with the best available techniques (BAT-AELs) for emissions to water given in these BAT conclusions refer to concentrations, expressed as mass of emitted substance per volume of water, and expressed in $\mu\text{g/l}$, mg/l , or g/l . The BAT-AELs refer to daily averages, i.e. 24-hour flow-proportional composite samples. Time-proportional composite samples can be used provided that sufficient flow stability can be demonstrated.

The monitoring associated with BAT-AELs for emissions to water is given in BAT 5

Energy efficiency levels associated with the best available techniques (BAT-AEELs)

An energy efficiency level associated with the best available techniques (BAT-AEEL) refers to the ratio between the combustion unit's net energy output(s) and the combustion unit's fuel/feedstock energy input at actual unit design. The net energy output(s) is determined at the combustion, gasification, or IGCC unit boundaries, including auxiliary systems (e.g. flue-gas treatment systems), and for the unit operated at full load.

In the case of combined heat and power (CHP) plants:

- the net total fuel utilisation BAT-AEEL refers to the combustion unit operated at full load and tuned to maximise primarily the heat supply and secondarily the remaining power that can be generated;
- the net electrical efficiency BAT-AEEL refers to the combustion unit generating only electricity at full load.

BAT-AEELs are expressed as a percentage. The fuel/feedstock energy input is expressed as lower heating value (LHV).

The monitoring associated with BAT-AEELs is given in BAT 2

Categorisation of combustion plants/units according to their total rated thermal input

For the purposes of these BAT conclusions, when a range of values for the total rated thermal input is indicated, this is to be read as 'equal to or greater than the lower end of the range and lower than the upper end of the range'. For example, the plant category 100–300 MW_{th} is to be

read as: combustion plants with a total rated thermal input equal to or greater than 100 MW and lower than 300 MW.

When a part of a combustion plant discharging flue-gases through one or more separate ducts within a common stack is operated less than 1 500 h/yr, that part of the plant may be considered separately for the purpose of these BAT conclusions. For all parts of the plant, the BAT-AELs apply in relation to the total rated thermal input of the plant. In such cases, the emissions through each of those ducts are monitored separately.

10.1 General BAT conclusions

The fuel-specific BAT conclusions included in Sections 10.2 to 10.7 apply in addition to the general BAT conclusions in this section.

10.1.1 Environmental management systems

BAT 1. In order to improve the overall environmental performance, BAT is to implement and adhere to an environmental management system (EMS) that incorporates all of the following features:

- i. commitment of the management, including senior management;
- ii. definition, by the management, of an environmental policy that includes the continuous improvement of the environmental performance of the installation;
- iii. planning and establishing the necessary procedures, objectives and targets, in conjunction with financial planning and investment;
- iv. implementation of procedures paying particular attention to:
 - (a) structure and responsibility
 - (b) recruitment, training, awareness and competence
 - (c) communication
 - (d) employee involvement
 - (e) documentation
 - (f) effective process control
 - (g) planned regular maintenance programmes
 - (h) emergency preparedness and response
 - (i) safeguarding compliance with environmental legislation;
- v. checking performance and taking corrective action, paying particular attention to:
 - (a) monitoring and measurement (see also the JRC Reference Report on Monitoring of emissions to air and water from IED-installations – ROM)
 - (b) corrective and preventive action
 - (c) maintenance of records
 - (d) independent (where practicable) internal and external auditing in order to determine whether or not the EMS conforms to planned arrangements and has been properly implemented and maintained;
- vi. review, by senior management, of the EMS and its continuing suitability, adequacy and effectiveness;
- vii. following the development of cleaner technologies;
- viii. consideration for the environmental impacts from the eventual decommissioning of the installation at the stage of designing a new plant, and throughout its operating life including:
 - (a) avoiding underground structures
 - (b) incorporating features that facilitate dismantling
 - (c) choosing surface finishes that are easily decontaminated
 - (d) using an equipment configuration that minimises trapped chemicals and facilitates drainage or cleaning
 - (e) designing flexible, self-contained equipment that enables phased closure
 - (f) using biodegradable and recyclable materials where possible;
- ix. application of sectoral benchmarking on a regular basis.

Specifically for this sector, it is also important to consider the following features of the EMS, described where appropriate in the relevant BAT:

- x. quality assurance/quality control programmes to ensure that the characteristics of all fuels are fully determined and controlled (see BAT 9);
- xi. a management plan in order to reduce emissions to air and/or to water during other than normal operating conditions, including start-up and shutdown periods (see BAT 10 and BAT 11);
- xii. a waste management plan to ensure that waste is avoided, prepared for reuse, recycled or otherwise recovered, including the use of techniques given in BAT 16;
- xiii. a systematic method to identify and deal with potential uncontrolled and/or unplanned emissions to the environment, in particular:
 - (a) emissions to soil and groundwater from the handling and storage of fuels, additives, by-products and wastes
 - (b) emissions associated with self-heating and/or self-ignition of fuel in the storage and handling activities;
- xiv. a dust management plan to prevent or, where that is not practicable, to reduce diffuse emissions from loading, unloading, storage and/or handling of fuels, residues and additives;
- xv. a noise management plan where a noise nuisance at sensitive receptors is expected or sustained, including:
 - (a) a protocol for conducting noise monitoring at the plant boundary
 - (b) a noise reduction programme
 - (c) a protocol for response to noise incidents containing appropriate actions and timelines
 - (d) a review of historic noise incidents, corrective actions and dissemination of noise incident knowledge to the affected parties;
- xvi. for the combustion, gasification or co-incineration of malodorous substances, an odour management plan including:
 - (a) a protocol for conducting odour monitoring
 - (b) where necessary, an odour elimination programme to identify and eliminate or reduce the odour emissions
 - (c) a protocol to record odour incidents and the appropriate actions and timelines
 - (d) a review of historic odour incidents, corrective actions and the dissemination of odour incident knowledge to the affected parties.

Where an assessment shows that any of the elements listed under items x to xvi are not necessary, a record is made of the decision, including the reasons.

Applicability

The scope (e.g. level of detail) and nature of the EMS (e.g. standardised or non-standardised) is generally related to the nature, scale and complexity of the installation, and the range of environmental impacts it may have.

10.1.2 Monitoring

BAT 2. BAT is to determine the net electrical efficiency and/or the net total fuel utilisation and/or the net mechanical energy efficiency of the gasification, IGCC and/or combustion units by carrying out a performance test at full load ⁽¹⁾, according to EN standards, after the commissioning of the unit and after each modification that could significantly affect the net electrical efficiency and/or the net total fuel utilisation and/or the net mechanical energy efficiency of the unit. If EN standards are not available, BAT is to use ISO, national or other international standards that ensure the provision of data of an equivalent scientific quality.

⁽¹⁾ In the case of CHP units, if for technical reasons the performance test cannot be carried out with the unit operated at full load for the heat supply, the test can be supplemented or substituted by a calculation using full load parameters.

BAT 3. BAT is to monitor key process parameters relevant for emissions to air and water including those given below.

Stream	Parameter(s)	Monitoring
Flue-gas	Flow	Periodic or continuous determination
	Oxygen content, temperature, and pressure	Periodic or continuous measurement
	Water vapour content ⁽¹⁾	
Waste water from flue-gas treatment	Flow, pH, and temperature	Continuous measurement
⁽¹⁾ The continuous measurement of the water vapour content of the flue-gas is not necessary if the sampled flue-gas is dried before analysis.		

BAT 4. BAT is to monitor emissions to air with at least the frequency given below and in accordance with EN standards. If EN standards are not available, BAT is to use ISO, national or other international standards that ensure the provision of data of an equivalent scientific quality.

Substance/ Parameter	Fuel/Process/Type of combustion plant	Combustion plant total rated thermal input	Standard(s) (¹)	Minimum monitoring frequency (²)	Monitoring associated with
NH ₃	<ul style="list-style-type: none"> When SCR and/or SNCR is used 	All sizes	Generic EN standards	Continuous (³) (⁴)	BAT 7
NO _x	<ul style="list-style-type: none"> Coal and/or lignite including waste co-incineration Solid biomass and/or peat including waste co-incineration HFO- and/or gas-oil-fired boilers and engines Gas-oil-fired gas turbines Natural-gas-fired boilers, engines, and turbines Iron and steel process gases Process fuels from the chemical industry IGCC plants 	All sizes	Generic EN standards	Continuous (³) (⁵)	BAT 20 BAT 24 BAT 28 BAT 32 BAT 37 BAT 41 BAT 42 BAT 43 BAT 47 BAT 48 BAT 56 BAT 64 BAT 65 BAT 73
	<ul style="list-style-type: none"> Combustion plants on offshore platforms 	All sizes	EN 14792	Once every year (⁶)	BAT 53
N ₂ O	<ul style="list-style-type: none"> Coal and/or lignite in circulating fluidised bed boilers Solid biomass and/or peat in circulating fluidised bed boilers 	All sizes	EN 21258	Once every year (⁷)	BAT 20 BAT 24

CO	<ul style="list-style-type: none"> • Coal and/or lignite including waste co-incineration • Solid biomass and/or peat including waste co-incineration • HFO- and/or gas-oil-fired boilers and engines • Gas-oil-fired gas turbines • Natural-gas-fired boilers, engines, and turbines • Iron and steel process gases • Process fuels from the chemical industry • IGCC plants 	All sizes	Generic EN standards	Continuous ⁽³⁾ ⁽⁵⁾	BAT 20 BAT 24 BAT 28 BAT 33 BAT 38 BAT 44 BAT 49 BAT 56 BAT 64 BAT 65 BAT 73
	<ul style="list-style-type: none"> • Combustion plants on offshore platforms 	All sizes	EN 15058	Once every year ⁽⁶⁾	BAT 54
SO ₂	<ul style="list-style-type: none"> • Coal and/or lignite including waste co-incineration • Solid biomass and/or peat including waste co-incineration • HFO- and/or gas-oil-fired boilers • HFO- and/or gas-oil-fired engines • Gas-oil-fired gas turbines • Iron and steel process gases • Process fuels from the chemical industry in boilers • IGCC plants 	All sizes	Generic EN standards and EN 14791	Continuous ⁽³⁾ ⁽⁸⁾ ⁽⁹⁾	BAT 21 BAT 25 BAT 29 BAT 34 BAT 39 BAT 50 BAT 57 BAT 66 BAT 67 BAT 74
SO ₃	<ul style="list-style-type: none"> • When SCR is used 	All sizes	No EN standard available	Once every year	—
Gaseous chlorides, expressed as HCl	<ul style="list-style-type: none"> • Coal and/or lignite • Process fuels from the chemical industry in boilers 	All sizes	EN 1911	Once every three months ⁽³⁾ ⁽¹⁰⁾ ⁽¹¹⁾	BAT 21 BAT 57
	<ul style="list-style-type: none"> • Solid biomass and/or peat 	All sizes	Generic EN standards	Continuous ⁽¹²⁾ ⁽¹³⁾	BAT 25
	<ul style="list-style-type: none"> • Waste co-incineration 	All sizes	Generic EN standards	Continuous ⁽³⁾ ⁽¹³⁾	BAT 66 BAT 67
HF	<ul style="list-style-type: none"> • Coal and/or lignite • Process fuels from the chemical industry in boilers 	All sizes	No EN standard available	Once every three months ⁽³⁾ ⁽¹⁰⁾ ⁽¹¹⁾	BAT 21 BAT 57
	<ul style="list-style-type: none"> • Solid biomass and/or peat 	All sizes	No EN standard available	Once every year	BAT 25

	<ul style="list-style-type: none"> Waste co-incineration 	All sizes	Generic EN standards	Continuous ⁽³⁾ (¹³)	BAT 66 BAT 67
Dust	<ul style="list-style-type: none"> Coal and/or lignite Solid biomass and/or peat HFO- and/or gas-oil-fired boilers Iron and steel process gases Process fuels from the chemical industry in boilers IGCC plants HFO- and/or gas-oil-fired engines Gas-oil-fired gas turbines 	All sizes	Generic EN standards and EN 13284-1 and EN 13284-2	Continuous ⁽³⁾ (¹⁴)	BAT 22 BAT 26 BAT 30 BAT 35 BAT 39 BAT 51 BAT 58 BAT 75
	Waste co-incineration	All sizes	Generic EN standards and EN 13284-2	Continuous	BAT 68 BAT 69
Metals and metalloids except mercury (As, Cd, Co, Cr, Cu, Mn, Ni, Pb, Sb, Se, Tl, V, Zn)	<ul style="list-style-type: none"> Coal and/or lignite Solid biomass and/or peat HFO- and/or gas-oil-fired boilers and engines 	All sizes	EN 14385	Once every year ⁽¹⁵⁾	BAT 22 BAT 26 BAT 30
	<ul style="list-style-type: none"> Waste co-incineration 	< 300 MW _{th}	EN 14385	Once every six months ⁽¹⁰⁾	BAT 68 BAT 69
		≥ 300 MW _{th}	EN 14385	Once every three months ⁽¹⁶⁾ ⁽¹⁰⁾	
	<ul style="list-style-type: none"> IGCC plants 	≥ 100 MW _{th}	EN 14385	Once every year ⁽¹⁵⁾	BAT 75
Hg	<ul style="list-style-type: none"> Coal and/or lignite including waste co-incineration 	< 300 MW _{th}	EN 13211	Once every three months ⁽¹⁰⁾ ⁽¹⁷⁾	BAT 23
		≥ 300 MW _{th}	Generic EN standards and EN 14884	Continuous ⁽¹³⁾ ⁽¹⁸⁾	
	<ul style="list-style-type: none"> Solid biomass and/or peat 	All sizes	EN 13211	Once every year ⁽¹⁹⁾	BAT 27
	<ul style="list-style-type: none"> Waste co-incineration with solid biomass and/or peat 	All sizes	EN 13211	Once every three months ⁽¹⁰⁾	BAT 70
	<ul style="list-style-type: none"> IGCC plants 	≥ 100 MW _{th}	EN 13211	Once every year ⁽²⁰⁾	BAT 75
TVOC	<ul style="list-style-type: none"> HFO- and/or gas-oil-fired engines Process fuels from the chemical industry in boilers 	All sizes	EN 12619	Once every six months ⁽¹⁰⁾	BAT 33 BAT 59
	<ul style="list-style-type: none"> Waste co-incineration with coal, lignite, solid biomass and/or peat 	All sizes	Generic EN standards	Continuous	BAT 71
Formaldehy	<ul style="list-style-type: none"> Natural-gas in 	All sizes	No EN	Once every	BAT 45

de	spark-ignited lean-burn gas and dual fuel engines		standard available	year	
CH ₄	<ul style="list-style-type: none"> Natural-gas-fired engines 	All sizes	EN ISO 25139	Once every year ⁽²¹⁾	BAT 45
PCDD/F	<ul style="list-style-type: none"> Process fuels from the chemical industry in boilers Waste co-incineration 	All sizes	EN 1948-1, EN 1948-2, EN 1948-3	Once every six months ⁽¹⁰⁾ ⁽²²⁾	BAT 59 BAT 71

(¹) Generic EN standards for continuous measurements are EN 15267-1, EN 15267-2, EN 15267-3, and EN 14181. EN standards for periodic measurements are given in the table.

(²) The monitoring frequency does not apply where plant operation would be for the sole purpose of performing an emission measurement.

(³) In the case of plants with a rated thermal input of < 100 MW operated < 1 500 h/yr, the minimum monitoring frequency may be at least once every six months. For gas turbines, periodic monitoring is carried out with a combustion plant load of > 70 %. For co-incineration of waste with coal, lignite, solid biomass and/or peat, the monitoring frequency needs to also take into account Part 6 of Annex VI to the IED.

(⁴) In the case of use of SCR, the minimum monitoring frequency may be at least once every year, if the emission levels are proven to be sufficiently stable.

(⁵) In the case of natural-gas-fired turbines with a rated thermal input of < 100 MW operated < 1 500 h/yr, or in the case of existing OCGTs, PEMS may be used instead.

(⁶) PEMS may be used instead.

(⁷) Two sets of measurements are carried out, one with the plant operated at loads of > 70 % and the other one at loads of < 70 %.

(⁸) As an alternative to the continuous measurement in the case of plants combusting oil with a known sulphur content and where there is no flue-gas desulphurisation system, periodic measurements at least once every three months and/or other procedures ensuring the provision of data of an equivalent scientific quality may be used to determine the SO₂ emissions.

(⁹) In the case of process fuels from the chemical industry, the monitoring frequency may be adjusted for plants of < 100 MW_{th} after an initial characterisation of the fuel (see BAT 5) based on an assessment of the relevance of pollutant releases (e.g. concentration in fuel, flue-gas treatment employed) in the emissions to air, but in any case at least each time that a change of the fuel characteristics may have an impact on the emissions.

(¹⁰) If the emission levels are proven to be sufficiently stable, periodic measurements may be carried out each time that a change of the fuel and/or waste characteristics may have an impact on the emissions, but in any case at least once every year. For co-incineration of waste with coal, lignite, solid biomass and/or peat, the monitoring frequency needs to also take into account Part 6 of Annex VI to the IED.

(¹¹) In the case of process fuels from the chemical industry, the monitoring frequency may be adjusted after an initial characterisation of the fuel (see BAT 5) based on an assessment of the relevance of pollutant releases (e.g. concentration in fuel, flue-gas treatment employed) in the emissions to air, but in any case at least each time that a change of the fuel characteristics may have an impact on the emissions.

(¹²) In the case of plants with a rated thermal input of < 100 MW operated < 500 h/yr, the minimum monitoring frequency may be at least once every year. In the case of plants with a rated thermal input of < 100 MW operated between 500 h/yr and 1 500 h/yr, the monitoring frequency may be reduced to at least once every six months.

(¹³) If the emission levels are proven to be sufficiently stable, periodic measurements may be carried out each time that a change of the fuel and/or waste characteristics may have an impact on the emissions, but in any case at least once every six months.

(¹⁴) In the case of plants combusting iron and steel process gases, the minimum monitoring frequency may be at least once every six months if the emission levels are proven to be sufficiently stable.

(¹⁵) The list of pollutants monitored and the monitoring frequency may be adjusted after an initial characterisation of the fuel (see BAT 5) based on an assessment of the relevance of pollutant releases (e.g. concentration in fuel, flue-gas treatment employed) in the emissions to air, but in any case at least each time that a change of the fuel characteristics may have an impact on the emissions.

(¹⁶) In the case of plants operated < 1 500 h/yr, the minimum monitoring frequency may be at least once every six months.

(¹⁷) In the case of plants operated < 1 500 h/yr, the minimum monitoring frequency may be at least once every year.

(¹⁸) Continuous sampling combined with frequent analysis of time-integrated samples, e.g. by a standardised sorbent trap monitoring method, may be used as an alternative to continuous measurements.

(¹⁹) If the emission levels are proven to be sufficiently stable due to the low mercury content in the fuel, periodic measurements may be carried out only each time that a change of the fuel characteristics may have an impact on the emissions.

(²⁰) The minimum monitoring frequency does not apply in the case of plants operated < 1 500 h/yr.

(²¹) Measurements are carried out with the plant operated at loads of > 70 %.

(²²) In the case of process fuels from the chemical industry, monitoring is only applicable when the fuels contain chlorinated substances.

BAT 5. BAT is to monitor emissions to water from flue-gas treatment with at least the frequency given below and in accordance with EN standards. If EN standards are not available, BAT is to use ISO, national or other international standards that ensure the provision of data of an equivalent scientific quality.

Substance/Parameter	Standard(s)	Minimum monitoring frequency	Monitoring associated with	
Total organic carbon (TOC) ⁽¹⁾	EN 1484	Once every month	BAT 15	
Chemical oxygen demand (COD) ⁽¹⁾	No EN standard available			
Total suspended solids (TSS)	EN 872			
Fluoride (F ⁻)	EN ISO 10304-1			
Sulphate (SO ₄ ²⁻)	EN ISO 10304-1			
Sulphide, easily released (S ²⁻)	No EN standard available			
Sulphite (SO ₃ ²⁻)	EN ISO 10304-3			
Metals and metalloids	As			Various EN standards available (e.g. EN ISO 11885 or EN ISO 17294-2)
	Cd			
	Cr			
	Cu			
	Ni			
	Pb			
	Zn			
	Hg	Various EN standards available (e.g. EN ISO 12846 or EN ISO 17852)		
Chloride (Cl ⁻)	Various EN standards available (e.g. EN ISO 10304-1 or EN ISO 15682)	—		
Total nitrogen	EN 12260	—		

⁽¹⁾ TOC monitoring and COD monitoring are alternatives. TOC monitoring is the preferred option because it does not rely on the use of very toxic compounds.

10.1.3 General environmental and combustion performance

BAT 6. In order to improve the general environmental performance of combustion plants and to reduce emissions to air of CO and unburnt substances, BAT is to ensure optimised combustion and to use an appropriate combination of the techniques given below.

Technique		Description	Applicability
a	Fuel blending and mixing	Ensure stable combustion conditions and/or reduce the emission of pollutants by mixing different qualities of the same fuel type	Generally applicable
b	Maintenance of the combustion system	Regular planned maintenance according to suppliers' recommendations	
c	Advanced control system	See description in Section 10.8.1	The applicability to old combustion plants may be constrained by the need to retrofit the combustion system and/or control command system
d	Good design of the combustion equipment	Good design of furnace, combustion chambers, burners and associated devices	Generally applicable to new combustion plants
e	Fuel choice	Select or switch totally or partially to another fuel(s) with a better environmental profile (e.g. with low sulphur and/or mercury content) amongst the available fuels, including in start-up situations or when back-up fuels are used	Applicable within the constraints associated with the availability of suitable types of fuel with a better environmental profile as a whole, which may be impacted by the energy policy of the Member State, or by the integrated site's fuel balance in the case of combustion of industrial process fuels. For existing combustion plants, the type of fuel chosen may be limited by the configuration and the design of the plant

BAT 7. In order to reduce emissions of ammonia to air from the use of selective catalytic reduction (SCR) and/or selective non-catalytic reduction (SNCR) for the abatement of NO_x emissions, BAT is to optimise the design and/or operation of SCR and/or SNCR (e.g. optimised reagent to NO_x ratio, homogeneous reagent distribution and optimum size of the reagent drops).

BAT-associated emission levels

The BAT-associated emission level (BAT-AEL) for emissions of NH₃ to air from the use of SCR and/or SNCR is < 3–10 mg/Nm³ as a yearly average or average over the sampling period. The lower end of the range can be achieved when using SCR and the upper end of the range can be achieved when using SNCR without wet abatement techniques. In the case of plants combusting biomass and operating at variable loads as well as in the case of engines combusting HFO and/or gas oil, the higher end of the BAT-AEL range is 15 mg/Nm³.

BAT 8. In order to prevent or reduce emissions to air during normal operating conditions, BAT is to ensure, by appropriate design, operation and maintenance, that the emission abatement systems are used at optimal capacity and availability.

BAT 9. In order to improve the general environmental performance of combustion and/or gasification plants and to reduce emissions to air, BAT is to include the following elements in the quality assurance/quality control programmes for all the fuels used, as part of the environmental management system (see BAT 1):

- i. Initial full characterisation of the fuel used including at least the parameters listed below and in accordance with EN standards. ISO, national or other international standards may be used provided they ensure the provision of data of an equivalent scientific quality;
- ii. Regular testing of the fuel quality to check that it is consistent with the initial characterisation and according to the plant design specifications. The frequency of testing and the parameters chosen from the table below are based on the variability of the fuel and an assessment of the relevance of pollutant releases (e.g. concentration in fuel, flue-gas treatment employed);
- iii. Subsequent adjustment of the plant settings as and when needed and practicable (e.g. integration of the fuel characterisation and control in the advanced control system (see description in Section 10.8.1)).

Description

Initial characterisation and regular testing of the fuel can be performed by the operator and/or the fuel supplier. If performed by the supplier, the full results are provided to the operator in the form of a product (fuel) supplier specification and/or guarantee.

Fuel(s)	Substances/Parameters subject to characterisation
Biomass/peat	<ul style="list-style-type: none"> • LHV • moisture
	<ul style="list-style-type: none"> • Ash • C, Cl, F, N, S, K, Na • Metals and metalloids (As, Cd, Cr, Cu, Hg, Pb, Zn)
Coal/lignite	<ul style="list-style-type: none"> • LHV • Moisture • Volatiles, ash, fixed carbon, C, H, N, O, S
	<ul style="list-style-type: none"> • Br, Cl, F
	<ul style="list-style-type: none"> • Metals and metalloids (As, Cd, Co, Cr, Cu, Hg, Mn, Ni, Pb, Sb, Tl, V, Zn)
HFO	<ul style="list-style-type: none"> • Ash • C, S, N, Ni, V
Gas oil	<ul style="list-style-type: none"> • Ash • N, C, S
Natural gas	<ul style="list-style-type: none"> • LHV • CH₄, C₂H₆, C₃, C₄₊, CO₂, N₂, Wobbe index
Process fuels from the chemical industry ⁽¹⁾	<ul style="list-style-type: none"> • Br, C, Cl, F, H, N, O, S • Metals and metalloids (As, Cd, Co, Cr, Cu, Hg, Mn, Ni, Pb, Sb, Tl, V, Zn)
Iron and steel process gases	<ul style="list-style-type: none"> • LHV, CH₄ (for COG), C_XH_Y (for COG), CO₂, H₂, N₂, total sulphur, dust, Wobbe index
Waste ⁽²⁾	<ul style="list-style-type: none"> • LHV • Moisture • Volatiles, ash, Br, C, Cl, F, H, N, O, S • Metals and metalloids (As, Cd, Co, Cr, Cu, Hg, Mn, Ni, Pb, Sb, Tl, V, Zn)
⁽¹⁾ The list of substances/parameters characterised can be reduced to only those that can reasonably be expected to be present in the fuel(s) based on information on the raw materials and the production processes.	
⁽²⁾ This characterisation is carried out without prejudice of application of the waste pre-acceptance and acceptance procedure set in BAT 60(a), which may lead to the characterisation and/or checking of other substances/parameters besides those listed here.	

BAT 10. In order to reduce emissions to air and/or to water during other than normal operating conditions (OTNOC), BAT is to set up and implement a management plan as part of the environmental management system (see BAT 1), commensurate with the relevance of potential pollutant releases, that includes the following elements:

- appropriate design of the systems considered relevant in causing OTNOC that may have an impact on emissions to air, water and/or soil (e.g. low-load design concepts for reducing the minimum start-up and shutdown loads for stable generation in gas turbines);
- set-up and implementation of a specific preventive maintenance plan for these relevant systems;
- review and recording of emissions caused by OTNOC and associated circumstances and implementation of corrective actions if necessary;
- periodic assessment of the overall emissions during OTNOC (e.g. frequency of events, duration, emissions quantification/estimation) and implementation of corrective actions if necessary.

BAT 11. BAT is to appropriately monitor emissions to air and/or to water during OTNOC.

Description

The monitoring can be carried out by direct measurement of emissions or by monitoring of surrogate parameters if this proves to be of equal or better scientific quality than the direct measurement of emissions. Emissions during start-up and shutdown (SU/SD) may be assessed based on a detailed emission measurement carried out for a typical SU/SD procedure at least once every year, and using the results of this measurement to estimate the emissions for each and every SU/SD throughout the year.

10.1.4 Energy efficiency

BAT 12. In order to increase the energy efficiency of combustion, gasification and/or IGCC units operated $\geq 1\,500$ h/yr, BAT is to use an appropriate combination of the techniques given below.

Technique		Description	Applicability
a	Combustion optimisation	See description in Section 10.8.2. Optimising the combustion minimises the content of unburnt substances in the flue-gases and in solid combustion residues	Generally applicable
b	Optimisation of the working medium conditions	Operate at the highest possible pressure and temperature of the working medium gas or steam, within the constraints associated with, for example, the control of NO _x emissions or the characteristics of energy demanded	
c	Optimisation of the steam cycle	Operate with lower turbine exhaust pressure by utilisation of the lowest possible temperature of the condenser cooling water, within the design conditions	
d	Minimisation of energy consumption	Minimising the internal energy consumption (e.g. greater efficiency of the feed-water pump)	
e	Preheating of combustion air	Reuse of part of the heat recovered from the combustion flue-gas to preheat the air used in combustion	Generally applicable within the constraints related to the need to control NO _x emissions
f	Fuel preheating	Preheating of fuel using recovered heat	Generally applicable within the constraints associated with the boiler design and the need to control NO _x emissions
g	Advanced control system	See description in Section 10.8.2. Computerised control of the main combustion parameters enables the combustion efficiency to be improved	Generally applicable to new units. The applicability to old units may be constrained by the need to retrofit the combustion system and/or control command system
h	Feed-water preheating using recovered heat	Preheat water coming out of the steam condenser with recovered heat, before reusing it in the boiler	Only applicable to steam circuits and not to hot boilers. Applicability to existing units may be limited due to constraints associated with the plant configuration and the amount of recoverable heat
i	Heat recovery by cogeneration (CHP)	Recovery of heat (mainly from the steam system) for producing hot water/steam to be used in industrial processes/activities or in a public network for district heating. Additional heat recovery is possible from: <ul style="list-style-type: none"> • flue-gas • grate cooling • circulating fluidised bed 	Applicable within the constraints associated with the local heat and power demand. The applicability may be limited in the case of gas compressors with an unpredictable operational heat profile
j	CHP readiness	See description in Section 10.8.2.	Only applicable to new units where there is a realistic potential for the future use of heat in the vicinity of the unit
k	Flue-gas condenser	See description in Section 10.8.2.	Generally applicable to CHP units provided there is enough demand for low-temperature heat

l	Heat accumulation	Heat accumulation storage in CHP mode	Only applicable to CHP plants. The applicability may be limited in the case of low heat load demand
m	Wet stack	See description in Section 10.8.2.	Generally applicable to new and existing units fitted with wet FGD
n	Cooling tower discharge	The release of emissions to air through a cooling tower and not via a dedicated stack	Only applicable to units fitted with wet FGD where reheating of the flue-gas is necessary before release, and where the unit cooling system is a cooling tower
o	Fuel pre-drying	The reduction of fuel moisture content before combustion to improve combustion conditions	Applicable to the combustion of biomass and/or peat within the constraints associated with spontaneous combustion risks (e.g. the moisture content of peat is kept above 40 % throughout the delivery chain). The retrofit of existing plants may be restricted by the extra calorific value that can be obtained from the drying operation and by the limited retrofit possibilities offered by some boiler designs or plant configurations
p	Minimisation of heat losses	Minimising residual heat losses, e.g. those that occur via the slag or those that can be reduced by insulating radiating sources	Only applicable to solid-fuel-fired combustion units and to gasification/IGCC units
q	Advanced materials	Use of advanced materials proven to be capable of withstanding high operating temperatures and pressures and thus to achieve increased steam/combustion process efficiencies	Only applicable to new plants
r	Steam turbine upgrades	This includes techniques such as increasing the temperature and pressure of medium-pressure steam, addition of a low-pressure turbine, and modifications to the geometry of the turbine rotor blades	The applicability may be restricted by demand, steam conditions and/or limited plant lifetime
s	Supercritical and ultra-supercritical steam conditions	Use of a steam circuit, including steam reheating systems, in which steam can reach pressures above 220.6 bar and temperatures above 374 °C in the case of supercritical conditions, and above 250 – 300 bar and temperatures above 580 – 600 °C in the case of ultra-supercritical conditions	Only applicable to new units of $\geq 600 \text{ MW}_{\text{th}}$ operated $> 4\,000 \text{ h/yr}$. Not applicable when the purpose of the unit is to produce low steam temperatures and/or pressures in process industries. Not applicable to gas turbines and engines generating steam in CHP mode. For units combusting biomass, the applicability may be constrained by high-temperature corrosion in the case of certain biomasses

10.1.5 Water usage and emissions to water

BAT 13. In order to reduce water usage and the volume of contaminated waste water discharged, BAT is to use one or both of the techniques given below.

Technique		Description	Applicability
a	Water recycling	Residual aqueous streams, including run-off water, from the plant are reused for other purposes. The degree of recycling is limited by the quality requirements of the recipient water stream and the water balance of the plant	Not applicable to waste water from cooling systems when water treatment chemicals and/or high concentrations of salts from seawater are present
b	Dry bottom ash handling	Dry, hot bottom ash falls from the furnace onto a mechanical conveyor system and is cooled down by ambient air. No water is used in the process.	Only applicable to plants combusting solid fuels. There may be technical restrictions that prevent retrofitting to existing combustion plants

BAT 14. In order to prevent the contamination of uncontaminated waste water and to reduce emissions to water, BAT is to segregate waste water streams and to treat them separately, depending on the pollutant content.

Description

Waste water streams that are typically segregated and treated include surface run-off water, cooling water, and waste water from flue-gas treatment.

Applicability

The applicability may be restricted in the case of existing plants due to the configuration of the drainage systems.

BAT 15. In order to reduce emissions to water from flue-gas treatment, BAT is to use an appropriate combination of the techniques given below, and to use secondary techniques as close as possible to the source in order to avoid dilution.

Technique	Typical pollutants prevented/abated	Applicability	
Primary techniques			
a	Optimised combustion (see BAT 6) and flue-gas treatment systems (e.g. SCR/SNCR, see BAT 7)	Organic compounds, ammonia (NH ₃)	Generally applicable
Secondary techniques ⁽¹⁾			
b	Adsorption on activated carbon	Organic compounds, mercury (Hg)	Generally applicable
c	Aerobic biological treatment	Biodegradable organic compounds, ammonium (NH ₄ ⁺)	Generally applicable for the treatment of organic compounds. Aerobic biological treatment of ammonium (NH ₄ ⁺) may not be applicable in the case of high chloride concentrations (i.e. around 10 g/l)
d	Anoxic/anaerobic biological treatment	Mercury (Hg), nitrate (NO ₃ ⁻), nitrite (NO ₂ ⁻)	Generally applicable
e	Coagulation and flocculation	Suspended solids	Generally applicable
f	Crystallisation	Metals and metalloids, sulphate (SO ₄ ²⁻), fluoride (F)	Generally applicable
g	Filtration (e.g. sand filtration, microfiltration, ultrafiltration)	Suspended solids, metals	Generally applicable
h	Flotation	Suspended solids, free oil	Generally applicable
i	Ion exchange	Metals	Generally applicable
j	Neutralisation	Acids, alkalis	Generally applicable
k	Oxidation	Sulphide (S ²⁻), sulphite (SO ₃ ²⁻)	Generally applicable
l	Precipitation	Metals and metalloids, sulphate (SO ₄ ²⁻), fluoride (F)	Generally applicable
m	Sedimentation	Suspended solids	Generally applicable
n	Stripping	Ammonia (NH ₃)	Generally applicable
⁽¹⁾ The descriptions of the techniques are given in Section 10.8.6			

The BAT-AELs refer to direct discharges to a receiving water body at the point where the emission leaves the installation.

Table 10.1: BAT-AELs for direct discharges to a receiving water body from flue-gas treatment

Substance/Parameter		BAT-AELs
		Daily average
Total organic carbon (TOC)		20–50 mg/l ⁽¹⁾ ⁽²⁾ ⁽³⁾
Chemical oxygen demand (COD)		60–150 mg/l ⁽¹⁾ ⁽²⁾ ⁽³⁾
Total suspended solids (TSS)		10–30 mg/l
Fluoride (F)		10–25 mg/l ⁽³⁾
Sulphate (SO ₄ ²⁻)		1.3–2.0 g/l ⁽³⁾ ⁽⁴⁾ ⁽⁵⁾ ⁽⁶⁾
Sulphide (S ²⁻), easily released		0.1–0.2 mg/l ⁽³⁾
Sulphite (SO ₃ ²⁻)		1–20 mg/l ⁽³⁾
Metals and metalloids	As	10–50 µg/l
	Cd	2–5 µg/l
	Cr	10–50 µg/l
	Cu	10–50 µg/l
	Hg	0.2–3 µg/l
	Ni	10–50 µg/l
	Pb	10–20 µg/l
	Zn	50–200 µg/l
<p>⁽¹⁾ Either the BAT-AEL for TOC or the BAT-AEL for COD applies. TOC is the preferred option because its monitoring does not rely on the use of very toxic compounds.</p> <p>⁽²⁾ This BAT-AEL applies after subtraction of the intake load.</p> <p>⁽³⁾ This BAT-AEL only applies to waste water from the use of wet FGD.</p> <p>⁽⁴⁾ This BAT-AEL only applies to combustion plants using calcium compounds in flue-gas treatment.</p> <p>⁽⁵⁾ The higher end of the BAT-AEL range may not apply in the case of highly saline waste water (e.g. chloride concentrations ≥ 5 g/l) due to the increased solubility of calcium sulphate.</p> <p>⁽⁶⁾ This BAT-AEL does not apply to discharges to the sea or to brackish water bodies.</p>		

10.1.6 Waste management

BAT 16. In order to reduce the quantity of waste sent for disposal from the combustion and/or gasification process and abatement techniques, BAT is to organise operations so as to maximise, in order of priority and taking into account life-cycle thinking:

- a. waste prevention, e.g. maximise the proportion of residues which arise as by-products;
- b. waste preparation for reuse, e.g. according to the specific requested quality criteria;
- c. waste recycling;
- d. other waste recovery (e.g. energy recovery),

by implementing an appropriate combination of techniques such as:

Technique		Description	Applicability
a	Generation of gypsum as a by-product	Quality optimisation of the calcium-based reaction residues generated by the wet FGD so that they can be used as a substitute for mined gypsum (e.g. as raw material in the plasterboard industry). The quality of limestone used in the wet FGD influences the purity of the gypsum produced	Generally applicable within the constraints associated with the required gypsum quality, the health requirements associated to each specific use, and by the market conditions
b	Recycling or recovery of residues in the construction sector	Recycling or recovery of residues (e.g. from semi-dry desulphurisation processes, fly ash, bottom ash) as a construction material (e.g. in road building, to replace sand in concrete production, or in the cement industry)	Generally applicable within the constraints associated with the required material quality (e.g. physical properties, content of harmful substances) associated to each specific use, and by the market conditions
c	Energy recovery by using waste in the fuel mix	The residual energy content of carbon-rich ash and sludges generated by the combustion of coal, lignite, heavy fuel oil, peat or biomass can be recovered for example by mixing with the fuel	Generally applicable where plants can accept waste in the fuel mix and are technically able to feed the fuels into the combustion chamber
d	Preparation of spent catalyst for reuse	Preparation of catalyst for reuse (e.g. up to four times for SCR catalysts) restores some or all of the original performance, extending the service life of the catalyst to several decades. Preparation of spent catalyst for reuse is integrated in a catalyst management scheme	The applicability may be limited by the mechanical condition of the catalyst and the required performance with respect to controlling NO _x and NH ₃ emissions

10.1.7 Noise emissions

BAT 17. In order to reduce noise emissions, BAT is to use one or a combination of the techniques given below.

	Technique	Description	Applicability
a	Operational measures	These include: <ul style="list-style-type: none"> • improved inspection and maintenance of equipment • closing of doors and windows of enclosed areas, if possible • equipment operated by experienced staff • avoidance of noisy activities at night, if possible • provisions for noise control during maintenance activities 	Generally applicable
b	Low-noise equipment	This potentially includes compressors, pumps and disks	Generally applicable when the equipment is new or replaced
c	Noise attenuation	Noise propagation can be reduced by inserting obstacles between the emitter and the receiver. Appropriate obstacles include protection walls, embankments and buildings	Generally applicable to new plants. In the case of existing plants, the insertion of obstacles may be restricted by lack of space
d	Noise-control equipment	This includes: <ul style="list-style-type: none"> • noise-reducers • equipment insulation • enclosure of noisy equipment • soundproofing of buildings 	The applicability may be restricted by lack of space
e	Appropriate location of equipment and buildings	Noise levels can be reduced by increasing the distance between the emitter and the receiver and by using buildings as noise screens	Generally applicable to new plants. In the case of existing plants, the relocation of equipment and production units may be restricted by lack of space or by excessive costs

10.2 BAT conclusions for the combustion of solid fuels

10.2.1 BAT conclusions for the combustion of coal and/or lignite

Unless otherwise stated, the BAT conclusions presented in this section are generally applicable to the combustion of coal and/or lignite. They apply in addition to the general BAT conclusions given in Section 10.1.

10.2.1.1 General environmental performance

BAT 18. In order to improve the general environmental performance of the combustion of coal and/or lignite, and in addition to BAT 6, BAT is to use the technique given below.

	Technique	Description	Applicability
a	Integrated combustion process ensuring high boiler efficiency and including primary techniques for NO _x reduction (e.g. air staging, fuel staging, low-NO _x burners (LNB) and/or flue-gas recirculation)	Combustion processes such as pulverised combustion, fluidised bed combustion or moving grate firing allow this integration	Generally applicable

10.2.1.2 Energy efficiency

BAT 19. In order to increase the energy efficiency of the combustion of coal and/or lignite, BAT is to use an appropriate combination of the techniques given in BAT 12 and below.

	Technique	Description	Applicability
a	Dry bottom ash handling	Dry hot bottom ash falls from the furnace onto a mechanical conveyor system and, after redirection to the furnace for reburning, is cooled down by ambient air. Useful energy is recovered from both the ash reburning and ash cooling	There may be technical restrictions that prevent retrofitting to existing combustion units

Table 10.2: BAT-associated energy efficiency levels (BAT-AEELs) for coal and/or lignite combustion

Type of combustion unit	BAT-AEELs ⁽¹⁾ ⁽²⁾		
	Net electrical efficiency (%) ⁽³⁾		Net total fuel utilisation (%) ⁽³⁾ ⁽⁴⁾ ⁽⁵⁾
	New unit ⁽⁶⁾ ⁽⁷⁾	Existing unit ⁽⁶⁾ ⁽⁸⁾	New or existing unit
Coal-fired, $\geq 1\ 000\ \text{MW}_{\text{th}}$	45–46	33.5–44	75–97
Lignite-fired, $\geq 1\ 000\ \text{MW}_{\text{th}}$	42–44 ⁽⁹⁾	33.5–42.5	75–97
Coal-fired, $< 1\ 000\ \text{MW}_{\text{th}}$	36.5–41.5 ⁽¹⁰⁾	32.5–41.5	75–97
Lignite-fired, $< 1\ 000\ \text{MW}_{\text{th}}$	36.5–40 ⁽¹¹⁾	31.5–39.5	75–97

⁽¹⁾ These BAT-AEELs do not apply in the case of units operated $< 1\ 500\ \text{h/yr}$.

⁽²⁾ In the case of CHP units, only one of the two BAT-AEELs 'Net electrical efficiency' or 'Net total fuel utilisation' applies, depending on the CHP unit design (i.e. either more oriented towards electricity generation or towards heat generation).

⁽³⁾ The lower end of the range may correspond to cases where the achieved energy efficiency is negatively affected (up to four percentage points) by the type of cooling system used or the geographical location of the unit.

⁽⁴⁾ These levels may not be achievable if the potential heat demand is too low.

⁽⁵⁾ These BAT-AEELs do not apply to plants generating only electricity.

⁽⁶⁾ The lower ends of the BAT-AEEL ranges are achieved in the case of unfavourable climatic conditions, low-grade lignite-fired units, and/or old units (first commissioned before 1985).

⁽⁷⁾ The higher end of the BAT-AEEL range can be achieved with high steam parameters (pressure, temperature).

⁽⁸⁾ The achievable electrical efficiency improvement depends on the specific unit, but an increase of more than three percentage points is considered as reflecting the use of BAT for existing units, depending on the original design of the unit and on the retrofits already performed.

⁽⁹⁾ In the case of units burning lignite with a lower heating value below $6\ \text{MJ/kg}$, the lower end of the BAT-AEEL range is 41.5 %.

⁽¹⁰⁾ The higher end of the BAT-AEEL range may be up to 46 % in the case of units of $\geq 600\ \text{MW}_{\text{th}}$ using supercritical or ultra-supercritical steam conditions.

⁽¹¹⁾ The higher end of the BAT-AEEL range may be up to 44 % in the case of units of $\geq 600\ \text{MW}_{\text{th}}$ using supercritical or ultra-supercritical steam conditions.

10.2.1.3 NO_x, N₂O and CO emissions to air

BAT 20. In order to prevent or reduce NO_x emissions to air while limiting CO and N₂O emissions to air from the combustion of coal and/or lignite, BAT is to use one or a combination of the techniques given below.

	Technique	Description	Applicability
a	Combustion optimisation	See description in Section 10.8.3. Generally used in combination with other techniques	Generally applicable
b	Combination of other primary techniques for NO _x reduction (e.g. air staging, fuel staging, flue-gas recirculation, low-NO _x burners (LNB))	See description in Section 10.8.3 for each single technique. The choice and performance of (an) appropriate (combination of) primary techniques may be influenced by the boiler design	
c	Selective non-catalytic reduction (SNCR)	See description in Section 10.8.3. Can be applied with 'slip' SCR	The applicability may be limited in the case of boilers with a high cross-sectional area preventing homogeneous mixing of NH ₃ and NO _x . The applicability may be limited in the case of combustion plants operated < 1 500 h/yr with highly variable boiler loads
d	Selective catalytic reduction (SCR)	See description in Section 10.8.3	Not applicable to combustion plants of < 300 MW _{th} operated < 500 h/yr. Not generally applicable to combustion plants of < 100 MW _{th} . There may be technical and economic restrictions for retrofitting existing combustion plants operated between 500 h/yr and 1 500 h/yr and for existing combustion plants of ≥ 300 MW _{th} operated < 500 h/yr
e	Combined techniques for NO _x and SO _x reduction	See description in Section 10.8.3	Applicable on a case-by-case basis, depending on the fuel characteristics and combustion process

Table 10.3: BAT-associated emission levels (BAT-AELs) for NO_x emissions to air from the combustion of coal and/or lignite

Combustion plant total rated thermal input (MW _{th})	BAT-AELs (mg/Nm ³)			
	Yearly average		Daily average or average over the sampling period	
	New plant	Existing plant ⁽¹⁾	New plant	Existing plant ⁽²⁾ ⁽³⁾
< 100	100–150	100–270	155–200	165–330
100–300	50–100	100–180	80–130	155–210
≥ 300, FBC boiler combusting coal and/or lignite and lignite-fired PC boiler	50–85	< 85–150 ⁽⁴⁾ ⁽⁵⁾	80–125	140–165 ⁽⁶⁾
≥ 300, coal-fired PC boiler	65–85	65–150	80–125	< 85–165 ⁽⁷⁾

⁽¹⁾ These BAT-AELs do not apply to plants operated < 1 500 h/yr.
⁽²⁾ In the case of coal-fired PC boiler plants put into operation no later than 1 July 1987, which are operated < 1 500 h/yr and for which SCR and/or SNCR is not applicable, the higher end of the range is 340 mg/Nm³.
⁽³⁾ For plants operated < 500 h/yr, these levels are indicative.
⁽⁴⁾ The lower end of the range is considered achievable when using SCR.
⁽⁵⁾ The higher end of the range is 175 mg/Nm³ for FBC boilers put into operation no later than 7 January 2014 and for lignite-fired PC boilers.
⁽⁶⁾ The higher end of the range is 220 mg/Nm³ for FBC boilers put into operation no later than 7 January 2014 and for lignite-fired PC boilers.
⁽⁷⁾ In the case of plants put into operation no later than 7 January 2014, the higher end of the range is 200 mg/Nm³ for plants operated ≥ 1 500 h/yr, and 220 mg/Nm³ for plants operated < 1 500 h/yr.

As an indication, the yearly average CO emission levels for existing combustion plants operated ≥ 1 500 h/yr or for new combustion plants will generally be as follows:

Combustion plant total rated thermal input (MW _{th})	CO indicative emission level (mg/Nm ³)
< 300	< 30–140
≥ 300, FBC boiler combusting coal and/or lignite and lignite-fired PC boiler	< 30–100 ⁽¹⁾
≥ 300, coal-fired PC boiler	< 5–100 ⁽¹⁾

⁽¹⁾ The higher end of the range may be up to 140 mg/Nm³ in the case of limitations due to boiler design, and/or in the case of fluidised bed boilers not fitted with secondary abatement techniques for NO_x emissions reduction.

10.2.1.4 SO_x, HCl and HF emissions to air

BAT 21. In order to prevent or reduce SO_x, HCl and HF emissions to air from the combustion of coal and/or lignite, BAT is to use one or a combination of the techniques given below.

Technique		Description	Applicability
a	Boiler sorbent injection (in-furnace or in-bed)	See description in Section 10.8.4	Generally applicable
b	Duct sorbent injection (DSI)	See description in Section 10.8.4. The technique can be used for HCl/HF removal when no specific FGD end-of-pipe technique is implemented	
c	Spray dry absorber (SDA)	See description in Section 10.8.4	
d	Circulating fluidised bed (CFB) dry scrubber		
e	Wet scrubbing	See description in Section 10.8.4. The techniques can be used for HCl/HF removal when no specific FGD end-of-pipe technique is implemented	
f	Wet flue-gas desulphurisation (wet FGD)	See description in Section 10.8.4	Not applicable to combustion plants operated < 500 h/yr. There may be technical and economic restrictions for applying the technique to combustion plants of < 300 MW _{th} , and for retrofitting existing combustion plants operated between 500 h/yr and 1 500 h/yr
g	Seawater FGD		Applicable on a case-by-case basis, depending on the fuel characteristics and combustion process
h	Combined techniques for NO _x and SO _x reduction		
i	Replacement or removal of the gas-gas heater located downstream of the wet FGD	Replacement of the gas-gas heater downstream of the wet FGD by a multi-pipe heat extractor, or removal and discharge of the flue-gas via a cooling tower or a wet stack	Only applicable when the heat exchanger needs to be changed or replaced in combustion plants fitted with wet FGD and a downstream gas-gas heater
j	Fuel choice	See description in Section 10.8.4. Use of fuel with low sulphur (e.g. down to 0.1 wt-%, dry basis), chlorine or fluorine content	Applicable within the constraints associated with the availability of different types of fuel, which may be impacted by the energy policy of the Member State. The applicability may be limited due to design constraints in the case of combustion plants combusting highly specific indigenous fuels

Table 10.4: BAT-associated emission levels (BAT-AELs) for SO₂ emissions to air from the combustion of coal and/or lignite

Combustion plant total rated thermal input (MW _{th})	BAT-AELs (mg/Nm ³)			
	Yearly average		Daily average	Daily average or average over the sampling period
	New plant	Existing plant ⁽¹⁾	New plant	Existing plant ⁽²⁾
< 100	150–200	150–360	170–220	170–400
100–300	80–150	95–200	135–200	135–220 ⁽³⁾
≥ 300, PC boiler	10–75	10–130 ⁽⁴⁾	25–110	25–165 ⁽⁵⁾
≥ 300, Fluidised bed boiler ⁽⁶⁾	20–75	20–180	25–110	50–220

⁽¹⁾ These BAT-AELs do not apply to plants operated < 1 500 h/yr.
⁽²⁾ For plants operated < 500 h/yr, these levels are indicative.
⁽³⁾ In the case of plants put into operation no later than 7 January 2014, the upper end of the BAT-AEL range is 250 mg/Nm³.
⁽⁴⁾ The lower end of the range can be achieved with the use of low-sulphur fuels in combination with the most advanced wet abatement system designs.
⁽⁵⁾ The higher end of the BAT-AEL range is 220 mg/Nm³ in the case of plants put into operation no later than 7 January 2014 and operated < 1 500 h/yr. For other existing plants put into operation no later than 7 January 2014, the higher end of the BAT-AEL range is 205 mg/Nm³.
⁽⁶⁾ For circulating fluidised bed boilers, the lower end of the range can be achieved by using high-efficiency wet FGD. The higher end of the range can be achieved by using boiler in-bed sorbent injection.

For a combustion plant with a total rated thermal input of more than 300 MW, which is specifically designed to fire indigenous lignite fuels and which can demonstrate that it cannot achieve the BAT-AELs mentioned in Table 10.4 for techno-economic reasons, the daily average BAT-AELs set out in Table 10.4 do not apply, and the upper end of the yearly average BAT-AEL range is as follows:

(i) for a new FGD system: $RCG \times 0.01$ with a maximum of 200 mg/Nm³;

(ii) for an existing FGD system: $RCG \times 0.03$ with a maximum of 320 mg/Nm³;

in which RCG represents the concentration of SO₂ in the raw flue-gas as a yearly average (under the standard conditions given under General considerations) at the inlet of the SO_x abatement system, expressed at a reference oxygen content of 6 vol-% O₂.

(iii) If boiler sorbent injection is applied as part of the FGD system, the RCG may be adjusted by taking into account the SO₂ reduction efficiency of this technique (η_{BSI}), as follows: $RCG(\text{adjusted}) = RCG(\text{measured}) / (1 - \eta_{BSI})$.

Table 10.5: BAT-associated emission levels (BAT-AELs) for HCl and HF emissions to air from the combustion of coal and/or lignite

Pollutant	Combustion plant total rated thermal input (MW _{th})	BAT-AELs (mg/Nm ³)	
		Yearly average or average of samples obtained during one year	
		New plant	Existing plant ⁽¹⁾
HCl	< 100	1–6	2–10 ⁽²⁾
	≥ 100	1–3	1–5 ⁽²⁾⁽³⁾
HF	< 100	< 1–3	< 1–6 ⁽⁴⁾
	≥ 100	< 1–2	< 1–3 ⁽⁴⁾

⁽¹⁾ The lower end of these BAT-AEL ranges may be difficult to achieve in the case of plants fitted with wet FGD and a downstream gas-gas heater.

⁽²⁾ The higher end of the BAT-AEL range is 20 mg/Nm³ in the following cases: plants combusting fuels where the average chlorine content is 1 000 mg/kg (dry) or higher; plants operated < 1 500 h/yr; FBC boilers. For plants operated < 500 h/yr, these levels are indicative.

⁽³⁾ In the case of plants fitted with wet FGD with a downstream gas-gas heater, the higher end of the BAT-AEL range is 7 mg/Nm³.

⁽⁴⁾ The higher end of the BAT-AEL range is 7 mg/Nm³ in the following cases: plants fitted with wet FGD with a downstream gas-gas heater; plants operated < 1 500 h/yr; FBC boilers. For plants operated < 500 h/yr, these levels are indicative.

10.2.1.5 Dust and particulate-bound metal emissions to air

BAT 22. In order to reduce dust and particulate-bound metal emissions to air from the combustion of coal and/or lignite, BAT is to use one or a combination of the techniques given below.

Technique		Description	Applicability
a	Electrostatic precipitator (ESP)	See description in Section 10.8.5	Generally applicable
b	Bag filter		
c	Boiler sorbent injection (in-furnace or in-bed)	See descriptions in Section 10.8.5. The techniques are mainly used for SO _x , HCl and/or HF control	
d	Dry or semi-dry FGD system		
e	Wet flue-gas desulphurisation (wet FGD)		See applicability in BAT 21

Table 10.6: BAT-associated emission levels (BAT-AELs) for dust emissions to air from the combustion of coal and/or lignite

Combustion plant total rated thermal input (MW _{th})	BAT-AELs (mg/Nm ³)			
	Yearly average		Daily average or average over the sampling period	
	New plant	Existing plant ⁽¹⁾	New plant	Existing plant ⁽²⁾
< 100	2–5	2–18	4–16	4–22 ⁽³⁾
100–300	2–5	2–14	3–15	4–22 ⁽⁴⁾
300–1 000	2–5	2–10 ⁽⁵⁾	3–10	3–11 ⁽⁶⁾
≥ 1 000	2–5	2–8	3–10	3–11 ⁽⁷⁾

⁽¹⁾ These BAT-AELs do not apply to plants operated < 1 500 h/yr.

⁽²⁾ For plants operated < 500 h/yr, these levels are indicative.

⁽³⁾ The higher end of the BAT-AEL range is 28 mg/Nm³ for plants put into operation no later than 7 January 2014.

⁽⁴⁾ The higher end of the BAT-AEL range is 25 mg/Nm³ for plants put into operation no later than 7 January 2014.

⁽⁵⁾ The higher end of the BAT-AEL range is 12 mg/Nm³ for plants put into operation no later than 7 January 2014.

⁽⁶⁾ The higher end of the BAT-AEL range is 20 mg/Nm³ for plants put into operation no later than 7 January 2014.

⁽⁷⁾ The higher end of the BAT-AEL range is 14 mg/Nm³ for plants put into operation no later than 7 January 2014.

10.2.1.6 Mercury emissions to air

BAT 23. In order to prevent or reduce mercury emissions to air from the combustion of coal and/or lignite, BAT is to use one or a combination of the techniques given below.

Technique	Description	Applicability
Co-benefit from techniques primarily used to reduce emissions of other pollutants		
a	Electrostatic precipitator (ESP)	Generally applicable
b	Bag filter	
c	Dry or semi-dry FGD system	
d	Wet flue-gas desulphurisation (wet FGD)	See applicability in BAT 21
e	Selective catalytic reduction (SCR)	See applicability in BAT 20
Specific techniques to reduce mercury emissions		
f	Carbon sorbent (e.g. activated carbon or halogenated activated carbon) injection in the flue-gas	Generally applicable
g	Use of halogenated additives in the fuel or injected in the furnace	Generally applicable in the case of a low halogen content in the fuel
h	Fuel pretreatment	Applicability is subject to a previous survey for characterising the fuel and for estimating the potential effectiveness of the technique
i	Fuel choice	Applicable within the constraints associated with the availability of different types of fuel, which may be impacted by the energy policy of the Member State

Table 10.7: BAT-associated emission levels (BAT-AELs) for mercury emissions to air from the combustion of coal and lignite

Combustion plant total rated thermal input (MW _{th})	BAT-AELs (µg/Nm ³)			
	Yearly average or average of samples obtained during one year			
	New plant		Existing plant ⁽¹⁾	
	coal	lignite	coal	lignite
< 300	< 1–3	< 1–5	< 1–9	< 1–10
≥ 300	< 1–2	< 1–4	< 1–4	< 1–7

⁽¹⁾ The lower end of the BAT-AEL range can be achieved with specific mercury abatement techniques.

10.2.2 BAT conclusions for the combustion of solid biomass and/or peat

Unless otherwise stated, the BAT conclusions presented in this section are generally applicable to the combustion of solid biomass and/or peat. They apply in addition to the general BAT conclusions given in Section 10.1

10.2.2.1 Energy efficiency

Table 10.8: BAT-associated energy efficiency levels (BAT-AEELs) for the combustion of solid biomass and/or peat

Type of combustion unit	BAT-AEELs ⁽¹⁾ ⁽²⁾			
	Net electrical efficiency (%) ⁽³⁾		Net total fuel utilisation (%) ⁽⁴⁾ ⁽⁵⁾	
	New unit ⁽⁶⁾	Existing unit	New unit	Existing unit
Solid biomass and/or peat boiler	33.5–to > 38	28–38	73–99	73–99

⁽¹⁾ These BAT-AEELs do not apply in the case of units operated < 1 500 h/yr.
⁽²⁾ In the case of CHP units, only one of the two BAT-AEELs 'Net electrical efficiency' or 'Net total fuel utilisation' applies, depending on the CHP unit design (i.e. either more oriented towards electricity generation or towards heat generation).
⁽³⁾ The lower end of the range may correspond to cases where the achieved energy efficiency is negatively affected (up to four percentage points) by the type of cooling system used or the geographical location of the unit.
⁽⁴⁾ These levels may not be achievable if the potential heat demand is too low.
⁽⁵⁾ These BAT-AEELs do not apply to plants generating only electricity.
⁽⁶⁾ The lower end of the range may be down to 32 % in the case of units of < 150 MW_{th} burning high-moisture biomass fuels.

10.2.2.2 NO_x, N₂O and CO emissions to air

BAT 24. In order to prevent or reduce NO_x emissions to air while limiting CO and N₂O emissions to air from the combustion of solid biomass and/or peat, BAT is to use one or a combination of the techniques given below.

Technique		Description	Applicability
a	Combustion optimisation	See descriptions in Section 10.8.3	Generally applicable
b	Low-NO _x burners (LNB)		
c	Air staging		
d	Fuel staging		
e	Flue-gas recirculation		
f	Selective non-catalytic reduction (SNCR)	See description in Section 10.8.3. Can be applied with 'slip' SCR	Not applicable to combustion plants operated < 500 h/yr with highly variable boiler loads. The applicability may be limited in the case of combustion plants operated between 500 h/yr and 1 500 h/yr with highly variable boiler loads. For existing combustion plants, applicable within the constraints associated with the required temperature window and residence time for the injected reactants
g	Selective catalytic reduction (SCR)	See description in Section 10.8.3. The use of high-alkali fuels (e.g. straw) may require the SCR to be installed downstream of the dust abatement system	Not applicable to combustion plants operated < 500 h/yr. There may be economic restrictions for retrofitting existing combustion plants of < 300 MW _{th} . Not generally applicable to existing combustion plants of < 100 MW _{th}

Table 10.9: BAT-associated emission levels (BAT-AELs) for NO_x emissions to air from the combustion of solid biomass and/or peat

Combustion plant total rated thermal input (MW _{th})	BAT-AELs (mg/Nm ³)			
	Yearly average		Daily average or average over the sampling period	
	New plant	Existing plant ⁽¹⁾	New plant	Existing plant ⁽²⁾
50–100	70–150 ⁽³⁾	70–225 ⁽⁴⁾	120–200 ⁽⁵⁾	120–275 ⁽⁶⁾
100–300	50–140	50–180	100–200	100–220
≥ 300	40–140	40–150 ⁽⁷⁾	65–150	95–165 ⁽⁸⁾

⁽¹⁾ These BAT-AELs do not apply to plants operated < 1 500 h/yr.
⁽²⁾ For combustion plants operated < 500 h/yr, these levels are indicative.
⁽³⁾ For plants burning fuels where the average potassium content is 2 000 mg/kg (dry) or higher, and/or the average sodium content is 300 mg/kg or higher, the higher end of the BAT-AEL range is 200 mg/Nm³.
⁽⁴⁾ For plants burning fuels where the average potassium content is 2 000 mg/kg (dry) or higher, and/or the average sodium content is 300 mg/kg or higher, the higher end of the BAT-AEL range is 250 mg/Nm³.
⁽⁵⁾ For plants burning fuels where the average potassium content is 2 000 mg/kg (dry) or higher, and/or the average sodium content is 300 mg/kg or higher, the higher end of the BAT-AEL range is 260 mg/Nm³.
⁽⁶⁾ For plants put into operation no later than 7 January 2014 and burning fuels where the average potassium content is 2 000 mg/kg (dry) or higher, and/or the average sodium content is 300 mg/kg or higher, the higher end of the BAT-AEL range is 310 mg/Nm³.
⁽⁷⁾ The higher end of the BAT-AEL range is 160 mg/Nm³ for plants put into operation no later than 7 January 2014.
⁽⁸⁾ The higher end of the BAT-AEL range is 200 mg/Nm³ for plants put into operation no later than 7 January 2014.

As an indication, the yearly average CO emission levels will generally be:

- < 30–250 mg/Nm³ for existing combustion plants of 50–100 MW_{th} operated ≥ 1 500 h/yr, or new combustion plants of 50–100 MW_{th};
- < 30–160 mg/Nm³ for existing combustion plants of 100–300 MW_{th} operated ≥ 1 500 h/yr, or new combustion plants of 100–300 MW_{th};
- < 30–80 mg/Nm³ for existing combustion plants of ≥ 300 MW_{th} operated ≥ 1 500 h/yr, or new combustion plants of ≥ 300 MW_{th}.

10.2.2.3 SO_x, HCl and HF emissions to air

BAT 25. In order to prevent or reduce SO_x, HCl and HF emissions to air from the combustion of solid biomass and/or peat, BAT is to use one or a combination of the techniques given below.

Technique		Description	Applicability
a	Boiler sorbent injection (in-furnace or in-bed)	See descriptions in Section 10.8.4	Generally applicable
b	Duct sorbent injection (DSI)		
c	Spray dry absorber (SDA)		
d	Circulating fluidised bed (CFB) dry scrubber		
e	Wet scrubbing		
f	Flue-gas condenser		
g	Wet flue-gas desulphurisation (wet FGD)		Not applicable to combustion plants operated < 500 h/yr. There may be technical and economic restrictions for retrofitting existing combustion plants operated between 500 h/yr and 1 500 h/yr
h	Fuel choice		Applicable within the constraints associated with the availability of different types of fuel, which may be impacted by the energy policy of the Member State

Table 10.10: BAT-associated emission levels (BAT-AELs) for SO₂ emissions to air from the combustion of solid biomass and/or peat

Combustion plant total rated thermal input (MW _{th})	BAT-AELs for SO ₂ (mg/Nm ³)			
	Yearly average		Daily average or average over the sampling period	
	New plant	Existing plant ⁽¹⁾	New plant	Existing plant ⁽²⁾
< 100	15–70	15–100	30–175	30–215
100–300	< 10–50	< 10–70 ⁽³⁾	< 20–85	< 20–175 ⁽⁴⁾
≥ 300	< 10–35	< 10–50 ⁽³⁾	< 20–70	< 20–85 ⁽⁵⁾

(¹) These BAT-AELs do not apply to plants operated < 1 500 h/yr.
(²) For plants operated < 500 h/yr, these levels are indicative.
(³) For existing plants burning fuels where the average sulphur content is 0.1 wt-% (dry) or higher, the higher end of the BAT-AEL range is 100 mg/Nm³.
(⁴) For existing plants burning fuels where the average sulphur content is 0.1 wt-% (dry) or higher, the higher end of the BAT-AEL range is 215 mg/Nm³.
(⁵) For existing plants burning fuels where the average sulphur content is 0.1 wt-% (dry) or higher, the higher end of the BAT-AEL range is 165 mg/Nm³, or 215 mg/Nm³ if those plants have been put into operation no later than 7 January 2014 and/or are FBC boilers combusting peat.

Table 10.11: BAT-associated emission levels (BAT-AELs) for HCl and HF emissions to air from the combustion of solid biomass and/or peat

Combustion plant total rated thermal input (MW _{th})	BAT-AELs for HCl (mg/Nm ³) ⁽¹⁾ ⁽²⁾				BAT-AELs for HF (mg/Nm ³)	
	Yearly average or average of samples obtained during one year		Daily average or average over the sampling period		Average over the sampling period	
	New plant	Existing plant ⁽³⁾ ⁽⁴⁾	New plant	Existing plant ⁽⁵⁾	New plant	Existing plant ⁽⁵⁾
< 100	1–7	1–15	1–12	1–35	< 1	< 1.5
100–300	1–5	1–9	1–12	1–12	< 1	< 1
≥ 300	1–5	1–5	1–12	1–12	< 1	< 1

(¹) For plants burning fuels where the average chlorine content is ≥ 0.1 wt-% (dry), or for existing plants co-combusting biomass with sulphur-rich fuel (e.g. peat) or using alkali chloride-converting additives (e.g. elemental sulphur), the higher end of the BAT-AEL range for the yearly average for new plants is 15 mg/Nm³, the higher end of the BAT-AEL range for the yearly average for existing plants is 25 mg/Nm³. The daily average BAT-AEL range does not apply to these plants.
(²) The daily average BAT-AEL range does not apply to plants operated < 1 500 h/yr. The higher end of the BAT-AEL range for the yearly average for new plants operated < 1 500 h/yr is 15 mg/Nm³.
(³) These BAT-AELs do not apply to plants operated < 1 500 h/yr.
(⁴) The lower end of these BAT-AEL ranges may be difficult to achieve in the case of plants fitted with wet FGD and a downstream gas-gas heater.
(⁵) For plants operated < 500 h/yr, these levels are indicative.

10.2.2.4 Dust and particulate-bound metal emissions to air

BAT 26. In order to reduce dust and particulate-bound metal emissions to air from the combustion of solid biomass and/or peat, BAT is to use one or a combination of the techniques given below.

Technique		Description	Applicability
a	Electrostatic precipitator (ESP)	See description in Section 10.8.5	Generally applicable
b	Bag filter		
c	Dry or semi-dry FGD system	See descriptions in Section 10.8.5 The techniques are mainly used for SO _x , HCl and/or HF control	See applicability in BAT 25
d	Wet flue-gas desulphurisation (wet FGD)		
e	Fuel choice	See description in Section 10.8.5	Applicable within the constraints associated with the availability of different types of fuel, which may be impacted by the energy policy of the Member State

Table 10.12: BAT-associated emission levels (BAT-AELs) for dust emissions to air from the combustion of solid biomass and/or peat

Combustion plant total rated thermal input (MW _{th})	BAT-AELs for dust (mg/Nm ³)			
	Yearly average		Daily average or average over the sampling period	
	New plant	Existing plant ⁽¹⁾	New plant	Existing plant ⁽²⁾
< 100	2–5	2–15	2–10	2–22
100–300	2–5	2–12	2–10	2–18
≥ 300	2–5	2–10	2–10	2–16

⁽¹⁾ These BAT-AELs do not apply to plants operated < 1 500 h/yr.
⁽²⁾ For plants operated < 500 h/yr, these levels are indicative.

10.2.2.5 Mercury emissions to air

BAT 27. In order to prevent or reduce mercury emissions to air from the combustion of solid biomass and/or peat, BAT is to use one or a combination of the techniques given below.

Technique		Description	Applicability
Specific techniques to reduce mercury emissions			
a	Carbon sorbent (e.g. activated carbon or halogenated activated carbon) injection in the flue-gas	See descriptions in Section 10.8.5	Generally applicable
b	Use of halogenated additives in the fuel or injected in the furnace		Generally applicable in the case of a low halogen content in the fuel
c	Fuel choice		Applicable within the constraints associated with the availability of different types of fuel, which may be impacted by the energy policy of the Member State
Co-benefit from techniques primarily used to reduce emissions of other pollutants			
d	Electrostatic precipitator (ESP)	See descriptions in Section 10.8.5. The techniques are mainly used for dust control	Generally applicable
e	Bag filter		
f	Dry or semi-dry FGD system	See descriptions in Section 10.8.5. The techniques are mainly used for SO _x , HCl and/or HF control	
g	Wet flue-gas desulphurisation (wet FGD)		See applicability in BAT 25

The BAT-associated emission level (BAT-AEL) for mercury emissions to air from the combustion of solid biomass and/or peat is < 1–5 µg/Nm³ as average over the sampling period.

10.3 BAT conclusions for the combustion of liquid fuels

The BAT conclusions presented in this section do not apply to combustion plants on offshore platforms; these are covered by Section 10.4.3

10.3.1 HFO- and/or gas-oil-fired boilers

Unless otherwise stated, the BAT conclusions presented in this section are generally applicable to the combustion of HFO and/or gas oil in boilers. They apply in addition to the general BAT conclusions given in Section 10.1

10.3.1.1 Energy efficiency

Table 10.13: BAT-associated energy efficiency levels (BAT-AEELs) for HFO and/or gas oil combustion in boilers

Type of combustion unit	BAT-AEELs ⁽¹⁾ ⁽²⁾			
	Net electrical efficiency (%)		Net total fuel utilisation (%) ⁽³⁾	
	New unit	Existing unit	New unit	Existing unit
HFO- and/or gas-oil-fired boiler	> 36.4	35.6–37.4	80–96	80–96

⁽¹⁾ These BAT-AEELs do not apply to units operated < 1 500 h/yr.
⁽²⁾ In the case of CHP units, only one of the two BAT-AEELs 'Net electrical efficiency' or 'Net total fuel utilisation' applies, depending on the CHP unit design (i.e. either more oriented towards electricity generation or towards heat generation).
⁽³⁾ These levels may not be achievable if the potential heat demand is too low.

10.3.1.2 NO_x and CO emissions to air

BAT 28. In order to prevent or reduce NO_x emissions to air while limiting CO emissions to air from the combustion of HFO and/or gas oil in boilers, BAT is to use one or a combination of the techniques given below.

Technique		Description	Applicability
a	Air staging	See descriptions in Section 10.8.3	Generally applicable
b	Fuel staging		
c	Flue-gas recirculation		
d	Low-NO _x burners (LNB)		
e	Water/steam addition		
f	Selective non-catalytic reduction (SNCR)	See descriptions in Section 10.8.3	Applicable within the constraints of water availability Not applicable to combustion plants operated < 500 h/yr with highly variable boiler loads. The applicability may be limited in the case of combustion plants operated between 500 h/yr and 1 500 h/yr with highly variable boiler loads
g	Selective catalytic reduction (SCR)	See descriptions in Section 10.8.3	Not applicable to combustion plants operated < 500 h/yr. There may be technical and economic restrictions for retrofitting existing combustion plants operated between 500 h/yr and 1 500 h/yr. Not generally applicable to combustion plants of < 100 MW _{th}
h	Advanced control system		Generally applicable to new combustion plants. The applicability to old combustion plants may be constrained by the need to retrofit the combustion system and/or control command system
i	Fuel choice		Applicable within the constraints associated with the availability of different types of fuel, which may be impacted by the energy policy of the Member State

Table 10.14: BAT-associated emission levels (BAT-AELs) for NO_x emissions to air from the combustion of HFO and/or gas oil in boilers

Combustion plant total rated thermal input (MW _{th})	BAT-AELs (mg/Nm ³)			
	Yearly average		Daily average or average over the sampling period	
	New plant	Existing plant ⁽¹⁾	New plant	Existing plant ⁽²⁾
< 100	75–200	150–270	100–215	210–330 ⁽³⁾
≥ 100	45–75	45–100 ⁽⁴⁾	85–100	85–110 ⁽³⁾ ⁽⁶⁾

⁽¹⁾ These BAT-AELs do not apply to plants operated < 1 500 h/yr.
⁽²⁾ For plants operated < 500 h/yr, these levels are indicative.
⁽³⁾ For industrial boilers and district heating plants put into operation no later than 27 November 2003, which are operated < 1 500 h/yr and for which SCR and/or SNCR is not applicable, the higher end of the BAT-AEL range is 450 mg/Nm³.
⁽⁴⁾ The higher end of the BAT-AEL range is 110 mg/Nm³ for plants of 100–300 MW_{th} and plants of ≥ 300 MW_{th} that were put into operation no later than 7 January 2014.
⁽⁵⁾ The higher end of the BAT-AEL range is 145 mg/Nm³ for plants of 100–300 MW_{th} and plants of ≥ 300 MW_{th} that were put into operation no later than 7 January 2014.
⁽⁶⁾ For industrial boilers and district heating plants of > 100 MW_{th} put into operation no later than 27 November 2003, which are operated < 1 500 h/yr and for which SCR and/or SNCR is not applicable, the higher end of the BAT-AEL range is 365 mg/Nm³.

As an indication, the yearly average CO emission levels will generally be:

- 10–30 mg/Nm³ for existing combustion plants of < 100 MW_{th} operated ≥ 1 500 h/yr, or new combustion plants of < 100 MW_{th};
- 10–20mg/Nm³ for existing combustion plants of ≥ 100 MW_{th} operated ≥ 1 500 h/yr, or new combustion plants of ≥ 100MW_{th}.

10.3.1.3 SO_x, HCl and HF emissions to air

BAT 29. In order to prevent or reduce SO_x, HCl and HF emissions to air from the combustion of HFO and/or gas oil in boilers, BAT is to use one or a combination of the techniques given below.

Technique		Description	Applicability
a	Duct sorbent injection (DSI)	See description in Section 10.8.4	Generally applicable
b	Spray dry absorber (SDA)		
c	Flue-gas condenser		
d	Wet flue-gas desulphurisation (wet FGD)		There may be technical and economic restrictions for applying the technique to combustion plants of < 300 MW _{th} . Not applicable to combustion plants operated < 500 h/yr. There may be technical and economic restrictions for retrofitting existing combustion plants operated between 500 h/yr and 1 500 h/yr
e	Seawater FGD		There may be technical and economic restrictions for applying the technique to combustion plants of < 300 MW _{th} . Not applicable to combustion plants operated < 500 h/yr. There may be technical and economic restrictions for retrofitting existing combustion plants operated between 500 h/yr and 1 500 h/yr
f	Fuel choice		Applicable within the constraints associated with the availability of different types of fuel, which may be impacted by the energy policy of the Member State

Table 10.15: BAT-associated emission levels (BAT-AELs) for SO₂ emissions to air from the combustion of HFO and/or gas oil in boilers

Combustion plant total rated thermal input (MW _{th})	BAT-AELs for SO ₂ (mg/Nm ³)			
	Yearly average		Daily average or average over the sampling period	
	New plant	Existing plant ⁽¹⁾	New plant	Existing plant ⁽²⁾
< 300	50–175	50–175	150–200	150–200 ⁽³⁾
≥ 300	35–50	50–110	50–120	150–165 ⁽⁴⁾ ⁽⁵⁾

⁽¹⁾ These BAT-AELs do not apply to plants operated < 1 500 h/yr.
⁽²⁾ For plants operated < 500 h/yr, these levels are indicative.
⁽³⁾ For industrial boilers and district heating plants put into operation no later than 27 November 2003 and operated < 1 500 h/yr, the higher end of the BAT-AEL range is 400 mg/Nm³.
⁽⁴⁾ The higher end of the BAT-AEL range is 175 mg/Nm³ for plants put into operation no later than 7 January 2014.
⁽⁵⁾ For industrial boilers and district heating plants put into operation no later than 27 November 2003, which are operated < 1 500 h/yr and for which wet FGD is not applicable, the higher end of the BAT-AEL range is 200 mg/Nm³.

10.3.1.4 Dust and particulate-bound metal emissions to air

BAT 30. In order to reduce dust and particulate-bound metal emissions to air from the combustion of HFO and/or gas oil in boilers, BAT is to use one or a combination of the techniques given below.

Technique		Description	Applicability	
a	Electrostatic precipitator (ESP)	See description in Section 10.8.5	Generally applicable	
b	Bag filter			
c	Multicyclones	See description in Section 10.8.5. Multicyclones can be used in combination with other dedusting techniques		
d	Dry or semi-dry FGD system	See descriptions in Section 10.8.5. The technique is mainly used for SO _x , HCl and/or HF control		
e	Wet flue-gas desulphurisation (wet FGD)	See description in Section 10.8.5. The technique is mainly used for SO _x , HCl and/or HF control		See applicability in BAT 29
f	Fuel choice	See description in Section 10.8.5		Applicable within the constraints associated with the availability of different types of fuel, which may be impacted by the energy policy of the Member State

Table 10.16: BAT-associated emission levels (BAT-AELs) for dust emissions to air from the combustion of HFO and/or gas oil in boilers

Combustion plant total rated thermal input (MW _{th})	BAT-AELs for dust (mg/Nm ³)			
	Yearly average		Daily average or average over the sampling period	
	New plant	Existing plant ⁽¹⁾	New plant	Existing plant ⁽²⁾
< 300	2–10	2–20	7–18	7–22 ⁽³⁾
≥ 300	2–5	2–10	7–10	7–11 ⁽⁴⁾

⁽¹⁾ These BAT-AELs do not apply to plants operated < 1 500 h/yr.
⁽²⁾ For plants operated < 500 h/yr, these levels are indicative.
⁽³⁾ The higher end of the BAT-AEL range is 25 mg/Nm³ for plants put into operation no later than 7 January 2014.
⁽⁴⁾ The higher end of the BAT-AEL range is 15 mg/Nm³ for plants put into operation no later than 7 January 2014.

10.3.2 HFO- and/or gas-oil-fired engines

Unless otherwise stated, the BAT conclusions presented in this section are generally applicable to the combustion of HFO and/or gas oil in reciprocating engines. They apply in addition to the general BAT conclusions given in Section 10.1.

As regards HFO- and/or gas-oil-fired engines, secondary abatement techniques for NO_x, SO₂ and dust may not be applicable to engines in islands that are part of a small isolated system ⁽¹⁾ or a micro isolated system ⁽²⁾, due to technical, economic and logistical/infrastructure constraints, pending their interconnection to the mainland electricity grid or access to a natural gas supply. The BAT-AELs for such engines shall therefore only apply in small isolated system and micro isolated system as from 1 January 2025 for new engines, and as from 1 January 2030 for existing engines.

⁽¹⁾ As defined in point 26 of Article 2 of Directive 2009/72/EC.

⁽²⁾ As defined in point 27 of Article 2 of Directive 2009/72/EC.

10.3.2.1 Energy efficiency

BAT 31. In order to increase the energy efficiency of HFO and/or gas oil combustion in reciprocating engines, BAT is to use an appropriate combination of the techniques given in BAT 12 and below.

Technique	Description	Applicability
a Combined cycle	See description in Section 10.8.2	Generally applicable to new units operated $\geq 1\,500$ h/yr. Applicable to existing units within the constraints associated with the steam cycle design and the space availability. Not applicable to existing units operated $< 1\,500$ h/yr

Table 10.17: BAT-associated energy efficiency levels (BAT-AEELs) for the combustion of HFO and/or gas oil in reciprocating engines

Type of combustion unit	BAT-AEELs ⁽¹⁾	
	Net electrical efficiency (%) ⁽²⁾	
	New unit	Existing unit
HFO- and/or gas-oil-fired reciprocating engine – single cycle	41.5–44.5 ⁽³⁾	38.3–44.5 ⁽³⁾
HFO- and/or gas-oil-fired reciprocating engine – combined cycle	> 48 ⁽⁴⁾	No BAT-AEEL

⁽¹⁾ These BAT-AEELs do not apply to units operated $< 1\,500$ h/yr.
⁽²⁾ Net electrical efficiency BAT-AEELs apply to CHP units whose design is oriented towards power generation, and to units generating only power.
⁽³⁾ These levels may be difficult to achieve in the case of engines fitted with energy-intensive secondary abatement techniques.
⁽⁴⁾ This level may be difficult to achieve in the case of engines using a radiator as a cooling system in dry, hot geographical locations.

10.3.2.2 NO_x, CO and volatile organic compound emissions to air

BAT 32. In order to prevent or reduce NO_x emissions to air from the combustion of HFO and/or gas oil in reciprocating engines, BAT is to use one or a combination of the techniques given below.

Technique		Description	Applicability
a	Low-NO _x combustion concept in diesel engines	See descriptions in Section 10.8.3	Generally applicable
b	Exhaust-gas recirculation (EGR)		Not applicable to four-stroke engines
c	Water/steam addition		Applicable within the constraints of water availability. The applicability may be limited where no retrofit package is available
d	Selective catalytic reduction (SCR)		Not applicable to combustion plants operated < 500 h/yr. There may be technical and economic restrictions for retrofitting existing combustion plants operated between 500 h/yr and 1 500 h/yr. Retrofitting existing combustion plants may be constrained by the availability of sufficient space

BAT 33. In order to prevent or reduce emissions of CO and volatile organic compounds to air from the combustion of HFO and/or gas oil in reciprocating engines, BAT is to use one or both of the techniques given below.

Technique		Description	Applicability
a	Combustion optimisation	See descriptions in Section 10.8.3	Generally applicable
b	Oxidation catalysts		Not applicable to combustion plants operated < 500 h/yr. The applicability may be limited by the sulphur content of the fuel

Table 10.18: BAT-associated emission levels (BAT-AELs) for NO_x emissions to air from the combustion of HFO and/or gas oil in reciprocating engines

Combustion plant total rated thermal input (MW _{th})	BAT-AELs (mg/Nm ³)			
	Yearly average		Daily average or average over the sampling period	
	New plant	Existing plant ⁽¹⁾	New plant	Existing plant ⁽²⁾ ⁽³⁾
≥ 50	115–190 ⁽⁴⁾	125–625	145–300	150–750

⁽¹⁾ These BAT-AELs do not apply to plants operated < 1 500 h/yr or to plants that cannot be fitted with secondary abatement techniques.
⁽²⁾ The BAT-AEL range is 1 150–1 900 mg/Nm³ for plants operated < 1 500 h/yr and for plants that cannot be fitted with secondary abatement techniques.
⁽³⁾ For plants operated < 500 h/yr, these levels are indicative.
⁽⁴⁾ For plants including units of < 20MW_{th} combusting HFO, the higher end of the BAT-AEL range applying to those units is 225 mg/Nm³.

As an indication, for existing combustion plants burning only HFO and operated $\geq 1\,500$ h/yr or new combustion plants burning only HFO,

- the yearly average CO emission levels will generally be 50–175 mg/Nm³;
- the average over the sampling period for TVOC emission levels will generally be 10–40 mg/Nm³.

10.3.2.3 SO_x, HCl and HF emissions to air

BAT 34. In order to prevent or reduce SO_x, HCl and HF emissions to air from the combustion of HFO and/or gas oil in reciprocating engines, BAT is to use one or a combination of the techniques given below.

Technique		Description	Applicability
a	Fuel choice	See descriptions in Section 10.8.4	Applicable within the constraints associated with the availability of different types of fuel, which may be impacted by the energy policy of the Member State
b	Duct sorbent injection (DSI)		There may be technical restrictions in the case of existing combustion plants Not applicable to combustion plants operated < 500 h/yr
c	Wet flue-gas desulphurisation (wet FGD)		There may be technical and economic restrictions for applying the technique to combustion plants of < 300 MW _{th} . Not applicable to combustion plants operated < 500 h/yr. There may be technical and economic restrictions for retrofitting existing combustion plants operated between 500 h/yr and 1 500 h/yr

Table 10.19: BAT-associated emission levels (BAT-AELs) for SO₂ emissions to air from the combustion of HFO and/or gas oil in reciprocating engines

Combustion plant total rated thermal input (MW _{th})	BAT-AELs for SO ₂ (mg/Nm ³)			
	Yearly average		Daily average or average over the sampling period	
	New plant	Existing plant ⁽¹⁾	New plant	Existing plant ⁽²⁾
All sizes	45–100	100–200 ⁽³⁾	60–110	105–235 ⁽³⁾

⁽¹⁾ These BAT-AELs do not apply to plants operated < 1 500 h/yr.
⁽²⁾ For plants operated < 500 h/yr, these levels are indicative.
⁽³⁾ The higher end of the BAT-AEL range is 280 mg/Nm³ if no secondary abatement technique can be applied. This corresponds to a sulphur content of the fuel of 0.5 wt-% (dry).

10.3.2.4 Dust and particulate-bound metal emissions to air

BAT 35. In order to prevent or reduce dust and particulate-bound metal emissions from the combustion of HFO and/or gas oil in reciprocating engines, BAT is to use one or a combination of the techniques given below.

Technique		Description	Applicability
a	Fuel choice	See descriptions in Section 10.8.5	Applicable within the constraints associated with the availability of different types of fuel, which may be impacted by the energy policy of the Member State
b	Electrostatic precipitator (ESP)		Not applicable to combustion plants operated < 500 h/yr
c	Bag filter		

Table 10.20: BAT-associated emission levels (BAT-AELs) for dust emissions to air from the combustion of HFO and/or gas oil in reciprocating engines

Combustion plant total rated thermal input (MW _{th})	BAT-AELs for dust (mg/Nm ³)			
	Yearly average		Daily average or average over the sampling period	
	New plant	Existing plant ⁽¹⁾	New plant	Existing plant ⁽²⁾
≥ 50	5–10	5–35	10–20	10–45

⁽¹⁾ These BAT-AELs do not apply to plants operated < 1 500 h/yr.
⁽²⁾ For plants operated < 500 h/yr, these levels are indicative.

10.3.3 Gas-oil-fired gas turbines

Unless stated otherwise, the BAT conclusions presented in this section are generally applicable to the combustion of gas oil in gas turbines. They apply in addition to the general BAT conclusions given in Section 10.1.

10.3.3.1 Energy efficiency

BAT 36. In order to increase the energy efficiency of gas oil combustion in gas turbines, BAT is to use an appropriate combination of the techniques given in BAT 12 and below.

Technique		Description	Applicability
a	Combined cycle	See description in Section 10.8.2	Generally applicable to new units operated ≥ 1 500 h/yr. Applicable to existing units within the constraints associated with the steam cycle design and the space availability. Not applicable to existing units operated < 1 500 h/yr

Table 10.21: BAT-associated energy efficiency levels (BAT-AEELs) for gas-oil-fired gas turbines

Type of combustion unit	BAT-AEELs ⁽¹⁾	
	Net electrical efficiency (%) ⁽²⁾	
	New unit	Existing unit
Gas-oil-fired open-cycle gas turbine	> 33	25–35.7
Gas-oil-fired combined cycle gas turbine	> 40	33–44

⁽¹⁾ These BAT-AEELs do not apply to units operated < 1 500 h/yr.
⁽²⁾ Net electrical efficiency BAT-AEELs apply to CHP units whose design is oriented towards power generation, and to units generating only power.

10.3.3.2 NO_x and CO emissions to air

BAT 37. In order to prevent or reduce NO_x emissions to air from the combustion of gas oil in gas turbines, BAT is to use one or a combination of the techniques given below.

Technique		Description	Applicability
a	Water/steam addition	See description in Section 10.8.3	The applicability may be limited due to water availability
b	Low-NO _x burners (LNB)		Only applicable to turbine models for which low-NO _x burners are available on the market
c	Selective catalytic reduction (SCR)		Not applicable to combustion plants operated < 500 h/yr. There may be technical and economic restrictions for retrofitting existing combustion plants operated between 500 h/yr and 1 500 h/yr. Retrofitting existing combustion plants may be constrained by the availability of sufficient space

BAT 38. In order to prevent or reduce CO emissions to air from the combustion of gas oil in gas turbines, BAT is to use one or a combination of the techniques given below.

Technique		Description	Applicability
a	Combustion optimisation	See description in Section 10.8.3	Generally applicable
b	Oxidation catalysts		Not applicable to combustion plants operated < 500 h/yr. Retrofitting existing combustion plants may be constrained by the availability of sufficient space

As an indication, the emission level for NO_x emissions to air from the combustion of gas oil in dual fuel gas turbines for emergency use operated < 500 h/yr will generally be 145–250 mg/Nm³ as a daily average or average over the sampling period.

10.3.3.3 SO_x and dust emissions to air

BAT 39. In order to prevent or reduce SO_x and dust emissions to air from the combustion of gas oil in gas turbines, BAT is to use the technique given below.

Technique		Description	Applicability
a.	Fuel choice	See description in Section 10.8.4	Applicable within the constraints associated with the availability of different types of fuel, which may be impacted by the energy policy of the Member State

Table 10.22: BAT-associated emission levels for SO₂ and dust emissions to air from the combustion of gas oil in gas turbines, including dual fuel gas turbines

Type of combustion plant	BAT-AELs (mg/Nm ³)			
	SO ₂		Dust	
	Yearly average ⁽¹⁾	Daily average or average over the sampling period ⁽²⁾	Yearly average ⁽¹⁾	Daily average or average over the sampling period ⁽²⁾
New and existing plants	35–60	50–66	2–5	2–10

⁽¹⁾ These BAT-AELs do not apply to existing plants operated < 1 500 h/yr.
⁽²⁾ For existing plants operated < 500 h/yr, these levels are indicative.

10.4 BAT conclusions for the combustion of gaseous fuels

10.4.1 BAT conclusions for the combustion of natural gas

Unless otherwise stated, the BAT conclusions presented in this section are generally applicable to the combustion of natural gas. They apply in addition to the general BAT conclusions given in Section 10.1. They do not apply to combustion plants on offshore platforms; these are covered by Section. 10.4.3.

10.4.1.1 Energy efficiency

BAT 40. In order to increase the energy efficiency of natural gas combustion, BAT is to use an appropriate combination of the techniques given in BAT 12 and below.

Technique	Description	Applicability
a Combined cycle	See description in Section 10.8.2	Generally applicable to new gas turbines and engines except when operated < 1 500 h/yr. Applicable to existing gas turbines and engines within the constraints associated with the steam cycle design and the space availability. Not applicable to existing gas turbines and engines operated < 1 500 h/yr. Not applicable to mechanical drive gas turbines operated in discontinuous mode with extended load variations and frequent start-ups and shutdowns. Not applicable to boilers

Table 10.23: BAT-associated energy efficiency levels (BAT-AEELs) for the combustion of natural gas

Type of combustion unit	BAT-AEELs ⁽¹⁾ ⁽²⁾				
	Net electrical efficiency (%)		Net total fuel utilisation (%) ⁽³⁾ ⁽⁴⁾	Net mechanical energy efficiency (%) ⁽⁴⁾ ⁽⁵⁾	
	New unit	Existing unit		New unit	Existing unit
Gas engine	39.5–44 ⁽⁶⁾	35–44 ⁽⁶⁾	56–85 ⁽⁶⁾	No BAT-AEEL.	
Gas-fired boiler	39–42.5	38–40	78–95	No BAT-AEEL.	
Open cycle gas turbine, ≥ 50 MW _{th}	36–41.5	33–41.5	No BAT-AEEL	36.5–41	33.5–41
Combined cycle gas turbine (CCGT)					
CCGT, 50–600 MW _{th}	53–58.5	46–54	No BAT-AEEL	No BAT-AEEL	
CCGT, ≥ 600 MW _{th}	57–60.5	50–60	No BAT-AEEL	No BAT-AEEL	
CHP CCGT, 50–600 MW _{th}	53–58.5	46–54	65–95	No BAT-AEEL	
CHP CCGT, ≥ 600 MW _{th}	57–60.5	50–60	65–95	No BAT-AEEL	

⁽¹⁾ These BAT-AEELs do not apply to units operated < 1 500 h/yr.
⁽²⁾ In the case of CHP units, only one of the two BAT-AEELs 'Net electrical efficiency' or 'Net total fuel utilisation' applies, depending on the CHP unit design (i.e. either more oriented towards electricity generation or heat generation).
⁽³⁾ Net total fuel utilisation BAT-AEELs may not be achievable if the potential heat demand is too low.
⁽⁴⁾ These BAT-AEELs do not apply to plants generating only electricity.
⁽⁵⁾ These BAT-AEELs apply to units used for mechanical drive applications.
⁽⁶⁾ These levels may be difficult to achieve in the case of engines tuned in order to reach NO_x levels lower than 190 mg/Nm³.

10.4.1.2 NO_x, CO, NMVOC and CH₄ emissions to air

BAT 41. In order to prevent or reduce NO_x emissions to air from the combustion of natural gas in boilers, BAT is to use one or a combination of the techniques given below.

Technique		Description	Applicability
a	Air and/or fuel staging	See descriptions in Section 10.8.3. Air staging is often associated with low-NO _x burners	Generally applicable
b	Flue-gas recirculation	See description in Section 10.8.3	
c	Low-NO _x burners (LNB)		
d	Advanced control system	See description in Section 10.8.3. This technique is often used in combination with other techniques or may be used alone for combustion plants operated < 500 h/yr	The applicability to old combustion plants may be constrained by the need to retrofit the combustion system and/or control command system
e	Reduction of the combustion air temperature	See description in Section 10.8.3	Generally applicable within the constraints associated with the process needs
f	Selective non-catalytic reduction (SNCR)		Not applicable to combustion plants operated < 500 h/yr with highly variable boiler loads. The applicability may be limited in the case of combustion plants operated between 500 h/yr and 1 500 h/yr with highly variable boiler loads
g	Selective catalytic reduction (SCR)		Not applicable to combustion plants operated < 500 h/yr. Not generally applicable to combustion plants of < 100 MW _{th} . There may be technical and economic restrictions for retrofitting existing combustion plants operated between 500 h/yr and 1 500 h/yr

BAT 42. In order to prevent or reduce NO_x emissions to air from the combustion of natural gas in gas turbines, BAT is to use one or a combination of the techniques given below.

Technique	Description	Applicability
a. Advanced control system	See description in Section 10.8.3. This technique is often used in combination with other techniques or may be used alone for combustion plants operated < 500 h/yr	The applicability to old combustion plants may be constrained by the need to retrofit the combustion system and/or control command system
b. Water/steam addition	See description in Section 10.8.3	The applicability may be limited due to water availability
c. Dry low-NO _x burners (DLN)		The applicability may be limited in the case of turbines where a retrofit package is not available or when water/steam addition systems are installed
d. Low-load design concept	Adaptation of the process control and related equipment to maintain good combustion efficiency when the demand in energy varies, e.g. by improving the inlet airflow control capability or by splitting the combustion process into decoupled combustion stages	The applicability may be limited by the gas turbine design
e. Low-NO _x burners (LNB)	See description in Section 10.8.3	Generally applicable to supplementary firing for heat recovery steam generators (HRSGs) in the case of combined-cycle gas turbine (CCGT) combustion plants
f. Selective catalytic reduction (SCR)		Not applicable in the case of combustion plants operated < 500 h/yr. Not generally applicable to existing combustion plants of < 100 MW _{th} . Retrofitting existing combustion plants may be constrained by the availability of sufficient space. There may be technical and economic restrictions for retrofitting existing combustion plants operated between 500 h/yr and 1 500 h/yr

BAT 43. In order to prevent or reduce NO_x emissions to air from the combustion of natural gas in engines, BAT is to use one or a combination of the techniques given below.

Technique	Description	Applicability
a. Advanced control system	See description in Section 10.8.3. This technique is often used in combination with other techniques or may be used alone for combustion plants operated < 500 h/yr	The applicability to old combustion plants may be constrained by the need to retrofit the combustion system and/or control command system
b. Lean-burn concept	See description in Section 10.8.3. Generally used in combination with SCR	Only applicable to new gas-fired engines
c. Advanced lean-burn concept	See descriptions in Section 10.8.3	Only applicable to new spark plug ignited engines
d. Selective catalytic reduction (SCR)		Retrofitting existing combustion plants may be constrained by the availability of sufficient space. Not applicable to combustion plants operated < 500 h/yr. There may be technical and economic restrictions for retrofitting existing combustion plants operated between 500 h/yr and 1 500 h/yr

BAT 44. In order to prevent or reduce CO emissions to air from the combustion of natural gas, BAT is to ensure optimised combustion and/or to use oxidation catalysts.

Description

See descriptions in Section 10.8.3.

Table 10.24: BAT-associated emission levels (BAT-AELs) for NO_x emissions to air from the combustion of natural gas in gas turbines

Type of combustion plant	Combustion plant total rated thermal input (MW _{th})	BAT-AELs (mg/Nm ³) ⁽¹⁾ ⁽²⁾	
		Yearly average ⁽³⁾ ⁽⁴⁾	Daily average or average over the sampling period
Open-cycle gas turbines (OCGTs) ⁽⁵⁾ ⁽⁶⁾			
New OCGT	≥ 50	15–35	25–50
Existing OCGT (excluding turbines for mechanical drive applications) – All but plants operated < 500 h/yr	≥ 50	15–50	25–55 ⁽⁷⁾
Combined-cycle gas turbines (CCGTs) ⁽⁵⁾ ⁽⁸⁾			
New CCGT	≥ 50	10–30	15–40
Existing CCGT with a net total fuel utilisation of < 75 %	≥ 600	10–40	18–50
Existing CCGT with a net total fuel utilisation of ≥ 75 %	≥ 600	10–50	18–55 ⁽⁹⁾
Existing CCGT with a net total fuel utilisation of < 75 %	50–600	10–45	35–55
Existing CCGT with a net total fuel utilisation of ≥ 75 %	50–600	25–50 ⁽¹⁰⁾	35–55 ⁽¹¹⁾
Open- and combined-cycle gas turbines			
Gas turbine put into operation no later than 27 November 2003, or existing gas turbine for emergency use and operated < 500 h/yr	≥ 50	No BAT-AEL	60–140 ⁽¹²⁾ ⁽¹³⁾
Existing gas turbine for mechanical drive applications – All but plants operated < 500 h/yr	≥ 50	15–50 ⁽¹⁴⁾	25–55 ⁽¹⁵⁾
<p>⁽¹⁾ These BAT-AELs also apply to the combustion of natural gas in dual-fuel-fired turbines.</p> <p>⁽²⁾ In the case of a gas turbine equipped with DLN, these BAT-AELs apply only when the DLN operation is effective.</p> <p>⁽³⁾ These BAT-AELs do not apply to existing plants operated < 1 500 h/yr.</p> <p>⁽⁴⁾ Optimising the functioning of an existing technique to reduce NO_x emissions further may lead to levels of CO emissions at the higher end of the indicative range for CO emissions given after this table.</p> <p>⁽⁵⁾ These BAT-AELs do not apply to existing turbines for mechanical drive applications or to plants operated < 500 h/yr.</p> <p>⁽⁶⁾ For plants with a net electrical efficiency (EE) greater than 39 %, a correction factor may be applied to the higher end of the range, corresponding to [higher end] x EE / 39, where EE is the net electrical energy efficiency or net mechanical energy efficiency of the plant determined at ISO baseload conditions.</p> <p>⁽⁷⁾ The higher end of the range is 80 mg/Nm³ in the case of plants which were put into operation no later than 27 November 2003 and are operated between 500 h/yr and 1 500 h/yr.</p> <p>⁽⁸⁾ For plants with a net electrical efficiency (EE) greater than 55 %, a correction factor may be applied to the higher end of the BAT-AEL range, corresponding to [higher end] x EE / 55, where EE is the net electrical efficiency of the plant determined at ISO baseload conditions.</p> <p>⁽⁹⁾ For existing plants put into operation no later than 7 January 2014, the higher end of the BAT-AEL range is 65 mg/Nm³.</p> <p>⁽¹⁰⁾ For existing plants put into operation no later than 7 January 2014, the higher end of the BAT-AEL range is 55 mg/Nm³.</p> <p>⁽¹¹⁾ For existing plants put into operation no later than 7 January 2014, the higher end of the BAT-AEL range is 80 mg/Nm³.</p> <p>⁽¹²⁾ The lower end of the BAT-AEL range for NO_x can be achieved with DLN burners.</p> <p>⁽¹³⁾ These levels are indicative.</p> <p>⁽¹⁴⁾ For existing plants put into operation no later than 7 January 2014, the higher end of the BAT-AEL range is 60 mg/Nm³.</p> <p>⁽¹⁵⁾ For existing plants put into operation no later than 7 January 2014, the higher end of the BAT-AEL range is 65 mg/Nm³.</p>			

As an indication, the yearly average CO emission levels for each type of existing combustion plant operated $\geq 1\,500$ h/yr and for each type of new combustion plant will generally be as follows:

- New OCGT of ≥ 50 MW_{th}: $< 5\text{--}40$ mg/Nm³. For plants with a net electrical efficiency (EE) greater than 39 %, a correction factor may be applied to the higher end of this range, corresponding to [higher end] x EE / 39, where EE is the net electrical energy efficiency or net mechanical energy efficiency of the plant determined at ISO baseload conditions.
- Existing OCGT of ≥ 50 MW_{th} (excluding turbines for mechanical drive applications): $< 5\text{--}40$ mg/Nm³. The higher end of this range will generally be 80 mg/Nm³ in the case of existing plants that cannot be fitted with dry techniques for NO_x reduction, or 50 mg/Nm³ for plants that operate at low load.
- New CCGT of ≥ 50 MW_{th}: $< 5\text{--}30$ mg/Nm³. For plants with a net electrical efficiency (EE) greater than 55 %, a correction factor may be applied to the higher end of the range, corresponding to [higher end] x EE / 55, where EE is the net electrical energy efficiency of the plant determined at ISO baseload conditions.
- Existing CCGT of ≥ 50 MW_{th}: $< 5\text{--}30$ mg/Nm³. The higher end of this range will generally be 50 mg/Nm³ for plants that operate at low load.
- Existing gas turbines of ≥ 50 MW_{th} for mechanical drive applications: $< 5\text{--}40$ mg/Nm³. The higher end of the range will generally be 50 mg/Nm³ when plants operate at low load.

In the case of a gas turbine equipped with DLN burners, these indicative levels correspond to when the DLN operation is effective.

Table 10.25: BAT-associated emission levels (BAT-AELs) for NO_x emissions to air from the combustion of natural gas in boilers and engines

Type of combustion plant	BAT-AELs (mg/Nm ³)			
	Yearly average ⁽¹⁾		Daily average or average over the sampling period	
	New plant	Existing plant ⁽²⁾	New plant	Existing plant ⁽³⁾
Boiler	10–60	50–100	30–85	85–110
Engine ⁽⁴⁾	20–75	20–100	55–85	55–110 ⁽⁵⁾

⁽¹⁾ Optimising the functioning of an existing technique to reduce NO_x emissions further may lead to levels of CO emissions at the higher end of the indicative range for CO emissions given after this table.
⁽²⁾ These BAT-AELs do not apply to plants operated $< 1\,500$ h/yr.
⁽³⁾ For plants operated < 500 h/yr, these levels are indicative.
⁽⁴⁾ These BAT-AELs only apply to spark-ignited and dual-fuel engines. They do not apply to gas-diesel engines.
⁽⁵⁾ In the case of engines for emergency use operated < 500 h/yr that could not apply the lean-burn concept or use SCR, the higher end of the indicative range is 175 mg/Nm³.

As an indication, the yearly average CO emission levels will generally be:

- $< 5\text{--}40$ mg/Nm³ for existing boilers operated $\geq 1\,500$ h/yr;
- $< 5\text{--}15$ mg/Nm³ for new boilers;
- $30\text{--}100$ mg/Nm³ for existing engines operated $\geq 1\,500$ h/yr and for new engines.

BAT 45. In order to reduce non-methane volatile organic compounds (NMVOC) and methane (CH₄) emissions to air from the combustion of natural gas in spark-ignited lean-burn gas engines, BAT is to ensure optimised combustion and/or to use oxidation catalysts.

Description

See descriptions in Section 10.8.3. Oxidation catalysts are not effective at reducing the emissions of saturated hydrocarbons containing less than four carbon atoms.

Table 10.26: BAT-associated emission levels (BAT-AELs) for formaldehyde and CH₄ emissions to air from the combustion of natural gas in a spark-ignited lean-burn gas engine

Combustion plant total rated thermal input (MW _{th})	BAT-AELs (mg/Nm ³)		
	Formaldehyde	CH ₄	
	Average over the sampling period		
	New or existing plant	New plant	Existing plant
≥ 50	5–15 ⁽¹⁾	215–500 ⁽²⁾	215–560 ⁽¹⁾⁽²⁾
⁽¹⁾ For existing plants operated < 500 h/yr, these levels are indicative.			
⁽²⁾ This BAT-AEL is expressed as C at full load operation.			

10.4.2 BAT conclusions for the combustion of iron and steel process gases

Unless otherwise stated, the BAT conclusions presented in this section are generally applicable to the combustion of iron and steel process gases (blast furnace gas, coke oven gas, basic oxygen furnace gas), individually, in combination, or simultaneously with other gaseous and/or liquid fuels. They apply in addition to the general BAT conclusions given in Section 10.1.

10.4.2.1 Energy efficiency

BAT 46. In order to increase the energy efficiency of the combustion of iron and steel process gases, BAT is to use an appropriate combination of the techniques given in BAT 12 and below.

Technique	Description	Applicability
a Process gas management system	See description in Section 10.8.2	Only applicable to integrated steelworks

Table 10.27: BAT-associated energy efficiency levels (BAT-AEELs) for the combustion of iron and steel process gases in boilers

Type of combustion unit	BAT-AEELs ⁽¹⁾ ⁽²⁾	
	Net electrical efficiency (%)	Net total fuel utilisation (%) ⁽³⁾
Existing multi-fuel firing gas boiler	30–40	50–84
New multi-fuel firing gas boiler ⁽⁴⁾	36–42.5	50–84
⁽¹⁾ These BAT-AEELs do not apply in the case of units operated < 1 500 h/yr.		
⁽²⁾ In the case of CHP units, only one of the two BAT-AEELs 'Net electrical efficiency' or 'Net total fuel utilisation' applies, depending on the CHP unit design (i.e. either more oriented towards electricity generation or towards heat generation).		
⁽³⁾ These BAT-AEELs do not apply to plants generating only electricity.		
⁽⁴⁾ The wide range of energy efficiencies in CHP units is largely dependent on the local demand for electricity and heat.		

Table 10.28: BAT-associated energy efficiency levels (BAT-AEELs) for the combustion of iron and steel process gases in CCGTs

Type of combustion unit	BAT-AEELs ⁽¹⁾ ⁽²⁾		
	Net electrical efficiency (%)		Net total fuel utilisation (%) ⁽³⁾
	New unit	Existing unit	
CHP CCGT	> 47	40–48	60–82
CCGT	> 47	40–48	No BAT-AEEL

⁽¹⁾ These BAT-AEELs do not apply in the case of units operated < 1 500 h/yr.
⁽²⁾ In the case of CHP units, only one of the two BAT-AEELs 'Net electrical efficiency' or 'Net total fuel utilisation' applies, depending on the CHP unit design (i.e. either more oriented towards electricity generation or towards heat generation).
⁽³⁾ These BAT-AEELs do not apply to plants generating only electricity.

10.4.2.2 NO_x and CO emissions to air

BAT 47. In order to prevent or reduce NO_x emissions to air from the combustion of iron and steel process gases in boilers, BAT is to use one or a combination of the techniques given below.

Technique	Description	Applicability
a Low-NO _x burners (LNB)	See description in Section 10.8.3. Specially designed low-NO _x burners in multiple rows per type of fuel or including specific features for multi-fuel firing (e.g. multiple dedicated nozzles for burning different fuels, or including fuels premixing)	Generally applicable
b Air staging	See descriptions in Section 10.8.3	
c Fuel staging		
d Flue-gas recirculation		
e Process gas management system	See description in Section 10.8.2.	Generally applicable within the constraints associated with the availability of different types of fuel
f Advanced control system	See description in Section 10.8.3. This technique is used in combination with other techniques	The applicability to old combustion plants may be constrained by the need to retrofit the combustion system and/or control command system
g Selective non-catalytic reduction (SNCR)	See descriptions in Section 10.8.3	Not applicable to combustion plants operated < 500 h/yr
h Selective catalytic reduction (SCR)		Not applicable to combustion plants operated < 500 h/yr. Not generally applicable to combustion plants of < 100 MW _{th} . Retrofitting existing combustion plants may be constrained by the availability of sufficient space and by the combustion plant configuration

BAT 48. In order to prevent or reduce NO_x emissions to air from the combustion of iron and steel process gases in CCGTs, BAT is to use one or a combination of the techniques given below.

Technique		Description	Applicability
a	Process gas management system	See description in Section 10.8.2	Generally applicable within the constraints associated with the availability of different types of fuel
b	Advanced control system	See description in Section 10.8.3. This technique is used in combination with other techniques	The applicability to old combustion plants may be constrained by the need to retrofit the combustion system and/or control command system
c	Water/steam addition	See description in Section 10.8.3. In dual fuel gas turbines using DLN for the combustion of iron and steel process gases, water/steam addition is generally used when combusting natural gas	The applicability may be limited due to water availability
d	Dry low-NO _x burners(DLN)	See description in Section 10.8.3. DLN that combust iron and steel process gases differ from those that combust natural gas only	Applicable within the constraints associated with the reactivity of iron and steel process gases such as coke oven gas. The applicability may be limited in the case of turbines where a retrofit package is not available or when water/steam addition systems are installed
e	Low-NO _x burners (LNB)	See description in Section 10.8.3	Only applicable to supplementary firing for heat recovery steam generators (HRSGs) of combined-cycle gas turbine (CCGT) combustion plants
f	Selective catalytic reduction (SCR)		Retrofitting existing combustion plants may be constrained by the availability of sufficient space

BAT 49. In order to prevent or reduce CO emissions to air from the combustion of iron and steel process gases, BAT is to use one or a combination of the techniques given below.

Technique		Description	Applicability
a	Combustion optimisation	See descriptions in Section 10.8.3	Generally applicable
b	Oxidation catalysts		Only applicable to CCGTs. The applicability may be limited by lack of space, the load requirements and the sulphur content of the fuel

Table 10.29: BAT-associated emission levels (BAT-AELs) for NO_x emissions to air from the combustion of 100 % iron and steel process gases

Type of combustion plant	O ₂ reference level (vol-%)	BAT-AELs (mg/Nm ³) ⁽¹⁾	
		Yearly average	Daily average or average over the sampling period
New boiler	3	15–65	22–100
Existing boiler	3	20–100 ⁽²⁾ ⁽³⁾	22–110 ⁽²⁾ ⁽⁴⁾ ⁽⁵⁾
New CCGT	15	20–35	30–50
Existing CCGT	15	20–50 ⁽²⁾ ⁽³⁾	30–55 ⁽²⁾ ⁽⁶⁾

⁽¹⁾ Plants combusting a mixture of gases with an equivalent LHV of > 20 MJ/Nm³ are expected to emit at the higher end of the BAT-AEL ranges.

⁽²⁾ The lower end of the BAT-AEL range can be achieved when using SCR.

⁽³⁾ For plants operated < 1 500 h/yr, these BAT AELs do not apply.

⁽⁴⁾ In the case of plants put into operation no later than 7 January 2014, the higher end of the BAT-AEL range is 160 mg/Nm³. Furthermore, the higher end of the BAT-AEL range may be exceeded when SCR cannot be used and when using a high share of COG (e.g. > 50 %) and/or when combusting COG with a relatively high level of H₂. In this case, the higher end of the BAT-AEL range is 220 mg/Nm³.

⁽⁵⁾ For plants operated < 500 h/yr, these levels are indicative.

⁽⁶⁾ In the case of plants put into operation no later than 7 January 2014, the higher end of the BAT-AEL range is 70 mg/Nm³.

As an indication, the yearly average CO emission levels will generally be:

- < 5–100 mg/Nm³ for existing boilers operated ≥ 1 500 h/yr;
- < 5–35 mg/Nm³ for new boilers;
- < 5–20 mg/Nm³ for existing CCGTs operated ≥ 1 500 h/yr or new CCGTs.

10.4.2.3 SO_x emissions to air

BAT 50. In order to prevent or reduce SO_x emissions to air from the combustion of iron and steel process gases, BAT is to use a combination of the techniques given below.

Technique	Description	Applicability
a Process gas management system and auxiliary fuel choice	See description in Section 10.8.2. To the extent allowed by the iron- and steel-works, maximise the use of: <ul style="list-style-type: none"> • a majority of blast furnace gas with a low sulphur content in the fuel diet; • a combination of fuels with a low averaged sulphur content, e.g. individual process fuels with a very low S content such as: <ul style="list-style-type: none"> ○ Blast furnace gas with a sulphur content < 10 mg/Nm³; ○ coke oven gas with a sulphur content < 300 mg/Nm³; • and auxiliary fuels such as: <ul style="list-style-type: none"> ○ natural gas; ○ liquid fuels with a sulphur content of ≤ 0.4 % (in boilers). Use of a limited amount of fuels with a higher sulphur content	Generally applicable within the constraints associated with the availability of different types of fuel
b Coke oven gas pretreatment at the iron- and steel-works	Use of one of the following techniques: <ul style="list-style-type: none"> • desulphurisation by absorption systems; • wet oxidative desulphurisation 	Only applicable to coke oven gas combustion plants

Table 10.30: BAT-associated emission levels (BAT-AELs) for SO₂ emissions to air from the combustion of 100 % iron and steel process gases

Type of combustion plant	O ₂ reference level (%)	BAT-AELs for SO ₂ (mg/Nm ³)	
		Yearly average ⁽¹⁾	Daily average or average over the sampling period ⁽²⁾
New or existing boiler	3	25–150	50–200 ⁽³⁾
New or existing CCGT	15	10–45	20–70

⁽¹⁾ For existing plants operated < 1 500 h/yr, these BAT AELs do not apply.
⁽²⁾ For existing plants operated < 500 h/yr, these levels are indicative.
⁽³⁾ The higher end of the BAT-AEL range may be exceeded when using a high share of COG (e.g. > 50 %). In this case, the higher end of the BAT-AEL range is 300 mg/Nm³.

10.4.2.4 Dust emissions to air

BAT 51. In order to reduce dust emissions to air from the combustion of iron and steel process gases, BAT is to use one or a combination of the techniques given below.

Technique		Description	Applicability
a	Fuel choice/management	Use of a combination of process gases and auxiliary fuels with a low averaged dust or ash content	Generally applicable within the constraints associated with the availability of different types of fuel
b	Blast furnace gas pretreatment at the iron- and steel-works	Use of one or a combination of dry dedusting devices (e.g. deflectors, dust catchers, cyclones, electrostatic precipitators) and/or subsequent dust abatement (venturi scrubbers, hurdle-type scrubbers, annular gap scrubbers, wet electrostatic precipitators, disintegrators)	Only applicable if blast furnace gas is combusted
c	Basic oxygen furnace gas pretreatment at the iron- and steel-works	Use of dry (e.g. ESP or bag filter) or wet (e.g. wet ESP or scrubber) dedusting. Further descriptions are given in the Iron and Steel BREF	Only applicable if basic oxygen furnace gas is combusted
d	Electrostatic precipitator (ESP)	See descriptions in Section 10.8.5	Only applicable to combustion plants combusting a significant proportion of auxiliary fuels with a high ash content
e	Bag filter		

Table 10.31: BAT-associated emission levels (BAT-AELs) for dust emissions to air from the combustion of 100 % iron and steel process gases

Type of combustion plant	BAT-AELs for dust (mg/Nm ³)	
	Yearly average ⁽¹⁾	Daily average or average over the sampling period ⁽²⁾
New or existing boiler	2–7	2–10
New or existing CCGT	2–5	2–5

⁽¹⁾ For existing plants operated < 1 500 h/yr, these BAT-AELs do not apply.
⁽²⁾ For existing plants operated < 500 h/yr, these levels are indicative

10.4.3 BAT conclusions for the combustion of gaseous and/or liquid fuels on offshore platforms

Unless otherwise stated, the BAT conclusions presented in this section are generally applicable to the combustion of gaseous and/or liquid fuels on offshore platforms. They apply in addition to the general BAT conclusions given in Section 10.1.

BAT 52. In order to improve the general environmental performance of the combustion of gaseous and/or liquid fuels on offshore platforms, BAT is to use one or a combination of the techniques given below.

Techniques		Description	Applicability
a	Process optimisation	Optimise the process in order to minimise the mechanical power requirements	Generally applicable
b	Control pressure losses	Optimise and maintain inlet and exhaust systems in a way that keeps the pressure losses as low as possible	
c	Load control	Operate multiple generator or compressor sets at load points which minimise emissions	
d	Minimise the 'spinning reserve'	When running with spinning reserve for operational reliability reasons, the number of additional turbines is minimised, except in exceptional circumstances	
e	Fuel choice	Provide a fuel gas supply from a point in the topside oil and gas process which offers a minimum range of fuel gas combustion parameters, e.g. calorific value, and minimum concentrations of sulphurous compounds to minimise SO ₂ formation. For liquid distillate fuels, preference is given to low-sulphur fuels	
f	Injection timing	Optimise injection timing in engines	
g	Heat recovery	Utilisation of gas turbine/engine exhaust heat for platform heating purposes	Generally applicable to new combustion plants. In existing combustion plants, the applicability may be restricted by the level of heat demand and the combustion plant layout (space)
h	Power integration of multiple gas fields / oilfields	Use of a central power source to supply a number of participating platforms located at different gas fields / oilfields	The applicability may be limited depending on the location of the different gas fields / oilfields and on the organisation of the different participating platforms, including alignment of time schedules regarding planning, start-up and cessation of production

BAT 53. In order to prevent or reduce NO_x emissions to air from the combustion of gaseous and/or liquid fuels on offshore platforms, BAT is to use one or a combination of the techniques given below.

Technique		Description	Applicability
a	Advanced control system	See descriptions in Section 10.8.3	The applicability to old combustion plants may be constrained by the need to retrofit the combustion system and/or control command system
b	Dry low-NO _x burners (DLN)		Applicable to new gas turbines (standard equipment) within the constraints associated with fuel quality variations. The applicability may be limited for existing gas turbines by: availability of a retrofit package (for low-load operation), complexity of the platform organisation and space availability
c	Lean-burn concept		Only applicable to new gas-fired engines
d	Low-NO _x burners (LNB)		Only applicable to boilers

BAT 54. In order to prevent or reduce CO emissions to air from the combustion of gaseous and/or liquid fuels in gas turbines on offshore platforms, BAT is to use one or a combination of the techniques given below.

Technique		Description	Applicability
a	Combustion optimisation	See descriptions in Section 10.8.3	Generally applicable
b	Oxidation catalysts		Not applicable to combustion plants operated < 500 h/yr. Retrofitting existing combustion plants may be constrained by the availability of sufficient space and by weight restrictions

Table 10.32 BAT-associated emission levels (BAT-AELs) for NO_x emissions to air from the combustion of gaseous fuels in open-cycle gas turbines on offshore platforms

Type of combustion plant	BAT-AELs (mg/Nm ³) ⁽¹⁾
	Average over the sampling period
New gas turbine combusting gaseous fuels ⁽²⁾	15–50 ⁽³⁾
Existing gas turbine combusting gaseous fuels ⁽²⁾	< 50–350 ⁽⁴⁾

⁽¹⁾ These BAT-AELs are based on > 70 % of baseload power available on the day.
⁽²⁾ This includes single fuel and dual fuel gas turbines.
⁽³⁾ The higher end of the BAT-AEL range is 250 mg/Nm³ if DLN burners are not applicable.
⁽⁴⁾ The lower end of the BAT-AEL range can be achieved with DLN burners.

As an indication, the average CO emission levels over the sampling period will generally be:

- < 100 mg/Nm³ for existing gas turbines combusting gaseous fuels on offshore platforms operated ≥ 1 500 h/yr;
- < 75 mg/Nm³ for new gas turbines combusting gaseous fuels on offshore platforms

10.5 BAT conclusions for multi-fuel-fired plants

10.5.1 BAT conclusions for the combustion of process fuels from the chemical industry

Unless otherwise stated, the BAT conclusions presented in this section are generally applicable to the combustion of process fuels from the chemical industry, individually, in combination, or simultaneously with other gaseous and/or liquid fuels. They apply in addition to the general BAT conclusions given in Section 10.1.

10.5.1.1 General environmental performance

BAT 55. In order to improve the general environmental performance of the combustion of process fuels from the chemical industry in boilers, BAT is to use an appropriate combination of the techniques given in BAT 6 and below.

Technique		Description	Applicability
a	Pretreatment of process fuel from the chemical industry	Perform fuel pretreatment on and/or off the site of the combustion plant to improve the environmental performance of fuel combustion	Applicable within the constraints associated with process fuel characteristics and space availability

10.5.1.2 Energy efficiency

Table 10.33: BAT-associated energy efficiency levels (BAT-AEELs) for the combustion of process fuels from the chemical industry in boilers

Type of combustion unit	BAT-AEELs ⁽¹⁾ ⁽²⁾			
	Net electrical efficiency (%)		Net total fuel utilisation (%) ⁽³⁾ ⁽⁴⁾	
	New unit	Existing unit	New unit	Existing unit
Boiler using liquid process fuels from the chemical industry, including when mixed with HFO, gas oil and/or other liquid fuels	> 36.4	35.6–37.4	80–96	80–96
Boiler using gaseous process fuels from the chemical industry, including when mixed with natural gas and/or other gaseous fuels	39–42.5	38–40	78–95	78–95

⁽¹⁾ These BAT-AEELs do not apply to units operated < 1 500 h/yr.
⁽²⁾ In the case of CHP units, only one of the two BAT-AEELs 'Net electrical efficiency' or 'Net total fuel utilisation' applies, depending on the CHP unit design (i.e. either more oriented towards generation electricity or towards heat generation).
⁽³⁾ These BAT-AEELs may not be achievable if the potential heat demand is too low.
⁽⁴⁾ These BAT-AEELs do not apply to plants generating only electricity.

10.5.1.3 NO_x and CO emissions to air

BAT 56. In order to prevent or reduce NO_x emissions to air while limiting CO emissions to air from the combustion of process fuels from the chemical industry, BAT is to use one or a combination of the techniques given below.

Technique		Description	Applicability
a	Low-NO _x burners (LNB)	See descriptions in Section 10.8.3	Generally applicable
b	Air staging		
c	Fuel staging	See description in Section 10.8.3. Applying fuel staging when using liquid fuel mixtures may require a specific burner design	
d	Flue-gas recirculation	See descriptions in Section 10.8.3	Generally applicable to new combustion plants. Applicable to existing combustion plants within the constraints associated with chemical installation safety
e	Water/steam addition		The applicability may be limited due to water availability
f	Fuel choice		Applicable within the constraints associated with the availability of different types of fuel and/or an alternative use of the process fuel
g	Advanced control system		The applicability to old combustion plants may be constrained by the need to retrofit the combustion system and/or control command system
h	Selective non-catalytic reduction (SNCR)		Applicable to existing combustion plants within the constraints associated with chemical installation safety. Not applicable to combustion plants operated < 500 h/yr. The applicability may be limited in the case of combustion plants operated between 500 h/yr and 1 500 h/yr with frequent fuel changes and frequent load variations
i	Selective catalytic reduction (SCR)		Applicable to existing combustion plants within the constraints associated with duct configuration, space availability and chemical installation safety. Not applicable to combustion plants operated < 500 h/yr. There may be technical and economic restrictions for retrofitting existing combustion plants operated between 500 h/yr and 1 500 h/yr. Not generally applicable to combustion plants of < 100 MW _{th}

Table 10.34: BAT-associated emission levels (BAT-AELs) for NO_x emissions to air from the combustion of 100 % process fuels from the chemical industry in boilers

Fuel phase used in the combustion plant	BAT-AELs (mg/Nm ³)			
	Yearly average		Daily average or average over the sampling period	
	New plant	Existing plant ⁽¹⁾	New plant	Existing plant ⁽²⁾
Mixture of gases and liquids	30–85	80–290 ⁽³⁾	50–110	100–330 ⁽³⁾
Gases only	20–80	70–100 ⁽⁴⁾	30–100	85–110 ⁽⁵⁾

⁽¹⁾ For plants operated < 1 500 h/yr, these BAT AELs do not apply.
⁽²⁾ For plants operated < 500 h/yr, these levels are indicative.
⁽³⁾ For existing plants of ≤ 500 MW_{th} put into operation no later than 27 November 2003 using liquid fuels with a nitrogen content higher than 0.6 wt-%, the higher end of the BAT-AEL range is 380 mg/Nm³.
⁽⁴⁾ For existing plants put into operation no later than 7 January 2014, the higher end of the BAT-AEL range is 180 mg/Nm³.
⁽⁵⁾ For existing plants put into operation no later than 7 January 2014, the higher end of the BAT-AEL range is 210 mg/Nm³.

As an indication, the yearly average CO emission levels for existing plants operated ≥ 1 500 h/yr and for new plants will generally be < 5–30 mg/Nm³.

10.5.1.4 SO_x, HCl and HF emissions to air

BAT 57. In order to reduce SO_x, HCl and HF emissions to air from the combustion of process fuels from the chemical industry in boilers, BAT is to use one or a combination of the techniques given below.

Technique		Description	Applicability
a	Fuel choice		Applicable within the constraints associated with the availability of different types of fuel and/or an alternative use of the process fuel
b	Boiler sorbent injection (in-furnace or in-bed)	See descriptions in Section 10.8.4	Applicable to existing combustion plants within the constraints associated with duct configuration, space availability and chemical installation safety. Wet FGD and seawater FGD are not applicable to combustion plants operated < 500 h/yr.
c	Duct sorbent injection (DSI)		
d	Spray dry absorber (SDA)		
e	Wet scrubbing		
f	Wet flue-gas desulphurisation (wet FGD)	See descriptions in Section 10.8.4	There may be technical and economic restrictions for applying wet FGD or seawater FGD to combustion plants of < 300 MW _{th} , and for retrofitting combustion plants operated between 500 h/yr and 1 500 h/yr with wet FGD or seawater FGD
g	Seawater FGD		

Table 10.35: BAT-associated emission levels (BAT-AELs) for SO₂ emissions to air from the combustion of 100 % process fuels from the chemical industry in boilers

Type of combustion plant	BAT-AELs (mg/Nm ³)	
	Yearly average ⁽¹⁾	Daily average or average over the sampling period ⁽²⁾
New and existing boilers	10–110	90–200

⁽¹⁾ For existing plants operated < 1 500 h/yr, these BAT-AELs do not apply.
⁽²⁾ For existing plants operated < 500 h/yr, these levels are indicative.

Table 10.36: BAT-associated emission levels (BAT-AELs) for HCl and HF emissions to air from the combustion of process fuels from the chemical industry in boilers

Combustion plant total rated thermal input (MW _{th})	BAT-AELs (mg/Nm ³)			
	HCl		HF	
	Average of samples obtained during one year			
	New plant	Existing plant ⁽¹⁾	New plant	Existing plant ⁽¹⁾
< 100	1–7	2–15 ⁽²⁾	< 1–3	< 1–6 ⁽³⁾
≥ 100	1–5	1–9 ⁽²⁾	< 1–2	< 1–3 ⁽³⁾

⁽¹⁾ For plants operated < 500 h/yr, these levels are indicative.
⁽²⁾ In the case of plants operated < 1 500 h/yr, the higher end of the BAT-AEL range is 20 mg/Nm³.
⁽³⁾ In the case of plants operated < 1 500 h/yr, the higher end of the BAT-AEL range is 7 mg/Nm³.

10.5.1.5 Dust and particulate-bound metal emissions to air

BAT 58. In order to reduce emissions to air of dust, particulate-bound metals, and trace species from the combustion of process fuels from the chemical industry in boilers, BAT is to use one or a combination of the techniques given below.

Technique		Description	Applicability
a	Electrostatic precipitator (ESP)	See descriptions in Section 10.8.5	Generally applicable
b	Bag filter		
c	Fuel choice	See description in Section 10.8.5. Use of a combination of process fuels from the chemical industry and auxiliary fuels with a low averaged dust or ash content	Applicable within the constraints associated with the availability of different types of fuel and/or an alternative use of the process fuel
d	Dry or semi-dry FGD system	See descriptions in Section 10.8.5. The technique is mainly used for SO _x , HCl and/or HF control	See applicability in BAT 57
e	Wet flue-gas desulphurisation (wet FGD)		

Table 10.37: BAT-associated emission levels (BAT-AELs) for dust emissions to air from the combustion of mixtures of gases and liquids composed of 100 % process fuels from the chemical industry in boilers

Combustion plant total rated thermal input (MW _{th})	BAT-AELs for dust (mg/Nm ³)			
	Yearly average		Daily average or average over the sampling period	
	New plant	Existing plant ⁽¹⁾	New plant	Existing plant ⁽²⁾
< 300	2–5	2–15	2–10	2–22 ⁽³⁾
≥ 300	2–5	2–10 ⁽⁴⁾	2–10	2–11 ⁽³⁾

(¹) For plants operated < 1 500 h/yr, these BAT-AELs do not apply.
(²) For plants operated < 500 h/yr, these levels are indicative.
(³) For plants put into operation no later than 7 January 2014, the higher end of the BAT-AEL range is 25 mg/Nm³.
(⁴) For plants put into operation no later than 7 January 2014, the higher end of the BAT-AEL range is 15 mg/Nm³.

10.5.1.6 Emissions of volatile organic compounds and polychlorinated dibenzo-dioxins and -furans to air

BAT 59. In order to reduce emissions to air of volatile organic compounds and polychlorinated dibenzo-dioxins and -furans from the combustion of process fuels from the chemical industry in boilers, BAT is to use one or a combination of the techniques given in BAT 6 and below.

Technique	Description	Applicability
a Activated carbon injection	See description in Section 10.8.5	Only applicable to combustion plants using fuels derived from chemical processes involving chlorinated substances. For the applicability of SCR and rapid quenching see BAT 56 and BAT 57
b Rapid quenching using wet scrubbing/flue-gas condenser	See description of wet scrubbing/flue-gas condenser in Section 10.8.4	
c Selective catalytic reduction (SCR)	See description in Section 10.8.3. The SCR system is adapted and larger than an SCR system only used for NO _x reduction	

Table 10.38: BAT-associated emission levels (BAT-AELs) for PCDD/F and TVOC emissions to air from the combustion of 100 % process fuels from the chemical industry in boilers

Pollutant	Unit	BAT-AELs
		Average over the sampling period
PCDD/F ⁽¹⁾	ng I-TEQ/Nm ³	< 0.012–0.036
TVOC	mg/Nm ³	0.6–12

(¹) These BAT-AELs only apply to plants using fuels derived from chemical processes involving chlorinated substances.

10.6 BAT conclusions for the co-incineration of waste

Unless otherwise stated, the BAT conclusions presented in this section are generally applicable to the co-incineration of waste in combustion plants. They apply in addition to the general BAT conclusions given in Section 10.1.

When waste is co-incinerated, the BAT-AELs in this section apply to the entire flue-gas volume generated.

In addition, when waste is co-incinerated together with the fuels covered by Section 10.2, the BAT-AELs set out in Section 10.2 also apply (i) to the entire flue-gas volume generated, and (ii) to the flue-gas volume resulting from the combustion of the fuels covered by that section using the mixing rule formula of Annex VI (part 4) to Directive 2010/75/EU, in which the BAT-AELs for the flue-gas volume resulting from the combustion of waste are to be determined on the basis of BAT 61.

10.6.1 General environmental performance

BAT 60. In order to improve the general environmental performance of the co-incineration of waste in combustion plants, to ensure stable combustion conditions, and to reduce emissions to air, BAT is to use technique BAT 60 (a) below and a combination of the techniques given in BAT 6 and/or the other techniques below.

Technique	Description	Applicability
a Waste pre-acceptance and acceptance	Implement a procedure for receiving any waste at the combustion plant according to the corresponding BAT from the Waste Treatment BREF. Acceptance criteria are set for critical parameters such as heating value, and the content of water, ash, chlorine and fluorine, sulphur, nitrogen, PCB, metals (volatile (e.g. Hg, Tl, Pb, Co, Se) and non-volatile (e.g. V, Cu, Cd, Cr, Ni)), phosphorus and alkali (when using animal by-products). Apply quality assurance systems for each waste load to guarantee the characteristics of the wastes co-incinerated and to control the values of defined critical parameters (e.g. EN 15358 for non-hazardous solid recovered fuel)	Generally applicable
b Waste selection/limitation	Careful selection of waste type and mass flow, together with limiting the percentage of the most polluted waste that can be co-incinerated. Limit the proportion of ash, sulphur, fluorine, mercury and/or chlorine in the waste entering the combustion plant. Limitation of the amount of waste to be co-incinerated	Applicable within the constraints associated with the waste management policy of the Member State
c Waste mixing with the main fuel	Effective mixing of waste and the main fuel, as a heterogeneous or poorly mixed fuel stream or an uneven distribution may influence the ignition and combustion in the boiler and should be prevented	Mixing is only possible when the grinding behaviour of the main fuel and waste is similar or when the amount of waste is very small compared to the main fuel

d	Waste drying	Pre-drying of the waste before introducing it into the combustion chamber, with a view to maintaining the high performance of the boiler	The applicability may be limited by insufficient recoverable heat from the process, by the required combustion conditions, or by the waste moisture content
e	Waste pretreatment	See techniques described in the Waste Treatment and Waste Incineration BREFs, including milling, pyrolysis and gasification	See applicability in the Waste Treatment BREF and in the Waste incineration BREF

BAT 61. In order to prevent increased emissions from the co-incineration of waste in combustion plants, BAT is to take appropriate measures to ensure that the emissions of polluting substances in the part of the flue-gases resulting from waste co-incineration are not higher than those resulting from the application of BAT conclusions for the incineration of waste.

BAT 62. In order to minimise the impact on residues recycling of the co-incineration of waste in combustion plants, BAT is to maintain a good quality of gypsum, ashes and slags as well as other residues, in line with the requirements set for their recycling when the plant is not co-incinerating waste, by using one or a combination of the techniques given in BAT 60 and/or by restricting the co-incineration to waste fractions with pollutant concentrations similar to those in other combusted fuels.

10.6.2 Energy efficiency

BAT 63. In order to increase the energy efficiency of the co-incineration of waste, BAT is to use an appropriate combination of the techniques given in BAT 12 and BAT 19, depending on the main fuel type used and on the plant configuration.

The BAT-associated energy efficiency levels (BAT-AEELs) are given in Table 10.40 for the co-incineration of waste with biomass and/or peat and in Table 10.39 for the co-incineration of waste with coal and/or lignite.

10.6.3 NO_x and CO emissions to air

BAT 64. In order to prevent or reduce NO_x emissions to air while limiting CO and N₂O emissions from the co-incineration of waste with coal and/or lignite, BAT is to use one or a combination of the techniques given in BAT 20.

BAT 65. In order to prevent or reduce NO_x emissions to air while limiting CO and N₂O emissions from the co-incineration of waste with biomass and/or peat, BAT is to use one or a combination of the techniques given in BAT 24.

10.6.4 SO_x, HCl and HF emissions to air

BAT 66. In order to prevent or reduce SO_x, HCl and HF emissions to air from the co-incineration of waste with coal and/or lignite, BAT is to use one or a combination of the techniques given in BAT 21.

BAT 67. In order to prevent or reduce SO_x, HCl and HF emissions to air from the co-incineration of waste with biomass and/or peat, BAT is to use one or a combination of the techniques given in BAT 25.

10.6.5 Dust and particulate-bound metal emissions to air

BAT 68. In order to reduce dust and particulate-bound metal emissions to air from the co-incineration of waste with coal and/or lignite, BAT is to use one or a combination of the techniques given in BAT 22.

Table 10.39: BAT-associated emission levels (BAT-AELs) for metal emissions to air from the co-incineration of waste with coal and/or lignite

Combustion plant total rated thermal input (MW _{th})	BAT-AELs		Averaging period
	Sb+As+Pb+Cr+Co+Cu+Mn+Ni+V (mg/Nm ³)	Cd+Tl (µg/Nm ³)	
< 300	0.005–0.5	5–12	Average over the sampling period
≥ 300	0.005–0.2	5–6	Average of samples obtained during one year

BAT 69. In order to reduce dust and particulate-bound metal emissions to air from the co-incineration of waste with biomass and/or peat, BAT is to use one or a combination of the techniques given in BAT 26.

Table 10.40: BAT-associated emission levels (BAT-AELs) for metal emissions to air from the co-incineration of waste with biomass and/or peat

BAT-AELs (average of samples obtained during one year)	
Sb+As+Pb+Cr+Co+Cu+Mn+Ni+V (mg/Nm ³)	Cd+Tl (µg/Nm ³)
0.075–0.3	< 5

10.6.6 Mercury emissions to air

BAT 70. In order to reduce mercury emissions to air from the co-incineration of waste with biomass, peat, coal and/or lignite, BAT is to use one or a combination of the techniques given in BAT 23 and BAT 27.

10.6.7 Emissions of volatile organic compounds and polychlorinated dibenzo-dioxins and -furans to air

BAT 71. In order to reduce emissions of volatile organic compounds and polychlorinated dibenzo-dioxins and -furans to air from the co-incineration of waste with biomass, peat, coal and/or lignite, BAT is to use a combination of the techniques given in BAT 6, BAT 26 and below.

Technique		Description	Applicability
a	Activated carbon injection	See description in Section 10.8.5. This process is based on the adsorption of pollutant molecules by the activated carbon	Generally applicable
b	Rapid quenching using wet scrubbing/flue-gas condenser	See description of wet scrubbing/flue-gas condenser in Section 10.8.4	
c	Selective catalytic reduction (SCR)	See description in Section 10.8.3. The SCR system is adapted and larger than an SCR system only used for NO _x reduction	See applicability in BAT 20 and in BAT 24

Table 10.41: BAT-associated emission levels (BAT-AELs) for PCDD/F and TVOC emissions to air from the co-incineration of waste with biomass, peat, coal and/or lignite

Type of combustion plant	BAT-AELs		
	PCDD/F (ng I-TEQ/Nm ³)	TVOC (mg/Nm ³)	
	Average over the sampling period	Yearly average	Daily average
Biomass-, peat-, coal- and/or lignite-fired combustion plant	< 0.01–0.03	< 0.1–5	0.5–10

10.7 BAT conclusions for gasification

Unless otherwise stated, the BAT conclusions presented in this section are generally applicable to all gasification plants directly associated to combustion plants, and to IGCC plants. They apply in addition to the general BAT conclusions given in Section 10.1.

10.7.1 Energy efficiency

BAT 72. In order to increase the energy efficiency of IGCC and gasification units, BAT is to use one or a combination of the techniques given in BAT 12 and below.

Technique		Description	Applicability
a	Heat recovery from the gasification process	As the syngas needs to be cooled down to be cleaned further, energy can be recovered for producing additional steam to be added to the steam turbine cycle, enabling additional electrical power to be produced	Only applicable to IGCC units and to gasification units directly associated to boilers with syngas pretreatment that requires cooling down of the syngas
b	Integration of gasification and combustion processes	The unit can be designed with full integration of the air supply unit (ASU) and the gas turbine, with all the air fed to the ASU being supplied (extracted) from the gas turbine compressor	The applicability is limited to IGCC units by the flexibility needs of the integrated plant to quickly provide the grid with electricity when renewable power plants are not available
c	Dry feedstock feeding system	Use of a dry system for feeding the fuel to the gasifier, in order to improve the energy efficiency of the gasification process	Only applicable to new units
d	High-temperature and -pressure gasification	Use of gasification technique with high-temperature and -pressure operating parameters, in order to maximise the efficiency of energy conversion	Only applicable to new units
e	Design improvements	Design improvements, such as: <ul style="list-style-type: none"> • modifications of the gasifier refractory and/or cooling system; • installation of an expander to recover energy from the syngas pressure drop before combustion 	Generally applicable to IGCC units

Table 10.42: BAT-associated energy efficiency levels (BAT-AEELs) for gasification and IGCC units

Type of combustion unit configuration	BAT-AEELs		
	Net electrical efficiency (%) of an IGCC unit		Net total fuel utilisation (%) of a new or existing gasification unit
	New unit	Existing unit	
Gasification unit directly associated to a boiler without prior syngas treatment	No BAT-AEEL		> 98
Gasification unit directly associated to a boiler with prior syngas treatment	No BAT-AEEL		> 91
IGCC unit	No BAT-AEEL	34–46	> 91

10.7.2 NO_x and CO emissions to air

BAT 73. In order to prevent and/or reduce NO_x emissions to air while limiting CO emissions to air from IGCC plants, BAT is to use one or a combination of the techniques given below.

Technique		Description	Applicability
a	Combustion optimisation	See description in Section 10.8.3	Generally applicable
b	Water/steam addition	See description in Section 10.8.3. Some intermediate-pressure steam from the steam turbine is reused for this purpose	Only applicable to the gas turbine part of the IGCC plant. The applicability may be limited due to water availability
c	Dry low-NO _x burners (DLN)	See description in Section 10.8.3	Only applicable to the gas turbine part of the IGCC plant. Generally applicable to new IGCC plants. Applicable on a case-by-case basis for existing IGCC plants, depending on the availability of a retrofit package. Not applicable for syngas with a hydrogen content of > 15 %
d	Syngas dilution with waste nitrogen from the air supply unit (ASU)	The ASU separates the oxygen from the nitrogen in the air, in order to supply high-quality oxygen to the gasifier. The waste nitrogen from the ASU is reused to reduce the combustion temperature in the gas turbine, by being premixed with the syngas before combustion	Only applicable when an ASU is used for the gasification process
e	Selective catalytic reduction (SCR)	See description in Section 10.8.3	Not applicable to IGCC plants operated < 500 h/yr. Retrofitting existing IGCC plants may be constrained by the availability of sufficient space. There may be technical and economic restrictions for retrofitting existing IGCC plants operated between 500 h/yr and 1 500 h/yr

Table 10.43: BAT-associated emission levels (BAT-AELs) for NO_x emissions to air from IGCC plants

IGCC plant total rated thermal input (MW _{th})	BAT-AELs (mg/Nm ³)			
	Yearly average		Daily average or average over the sampling period	
	New plant	Existing plant	New plant	Existing plant
≥ 100	10–25	12–45	1–35	1–60

As an indication, the yearly average CO emission levels for existing plants operated ≥ 1 500 h/yr and for new plants will generally be < 5–30 mg/Nm³.

10.7.3 SO_x emissions to air

BAT 74. In order to reduce SO_x emissions to air from IGCC plants, BAT is to use the technique given below.

Technique	Description	Applicability
a Acid gas removal	Sulphur compounds from the feedstock of a gasification process are removed from the syngas via acid gas removal, e.g. including a COS (and HCN) hydrolysis reactor and the absorption of H ₂ S using a solvent such as methyl diethanolamine. Sulphur is then recovered as either liquid or solid elemental sulphur (e.g. through a Claus unit), or as sulphuric acid, depending on market demands	The applicability may be limited in the case of biomass IGCC plants due to the very low sulphur content in biomass

The BAT-associated emission level (BAT-AEL) for SO₂ emissions to air from IGCC plants of ≥ 100 MW_{th} is 3–16 mg/Nm³, expressed as a yearly average.

10.7.4 Dust, particulate-bound metal, ammonia and halogen emissions to air

BAT 75. In order to prevent or reduce dust, particulate-bound metal, ammonia and halogen emissions to air from IGCC plants, BAT is to use one or a combination of the techniques given below.

Technique	Description	Applicability
a Syngas filtration	Dedusting using fly ash cyclones, bag filters, ESPs and/or candle filters to remove fly ash and unconverted carbon. Bag filters and ESPs are used in the case of syngas temperatures up to 400 °C	Generally applicable
b Syngas tars and ashes recirculation to the gasifier	Tars and ashes with a high carbon content generated in the raw syngas are separated in cyclones and recirculated to the gasifier, in the case of a low syngas temperature at the gasifier outlet (< 1 100 °C)	
c Syngas washing	Syngas passes through a water scrubber, downstream of other dedusting technique(s), where chlorides, ammonia, particles and halides are separated	

Table 10.44: BAT-associated emission levels (BAT-AELs) for dust and particulate-bound metal emissions to air from IGCC plants

IGCC plant total rated thermal input (MW _{th})	BAT-AELs		
	Sb+As+Pb+Cr+Co+Cu+Mn+Ni+V (mg/Nm ³) (Average over the sampling period)	Hg (µg/Nm ³) (Average over the sampling period)	Dust (mg/Nm ³) (yearly average)
≥ 100	< 0.025	< 1	< 2.5

10.8 Description of techniques

10.8.1 General techniques

Technique	Description
Advanced control system	The use of a computer-based automatic system to control the combustion efficiency and support the prevention and/or reduction of emissions. This also includes the use of high-performance monitoring.
Combustion optimisation	Measures taken to maximise the efficiency of energy conversion, e.g. in the furnace/boiler, while minimising emissions (in particular of CO). This is achieved by a combination of techniques including good design of the combustion equipment, optimisation of the temperature (e.g. efficient mixing of the fuel and combustion air) and residence time in the combustion zone, and use of an advanced control system.

10.8.2 Techniques to increase energy efficiency

Technique	Description
Advanced control system	See Section 10.8.1
CHP readiness	The measures taken to allow the later export of a useful quantity of heat to an off-site heat load in a way that will achieve at least a 10 % reduction in primary energy usage compared to the separate generation of the heat and power produced. This includes identifying and retaining access to specific points in the steam system from which steam can be extracted, as well as making sufficient space available to allow the later fitting of items such as pipework, heat exchangers, extra water demineralisation capacity, standby boiler plant and back-pressure turbines. Balance of Plant (BoP) systems and control/instrumentation systems are suitable for upgrade. Later connection of back-pressure turbine(s) is also possible.
Combined cycle	Combination of two or more thermodynamic cycles, e.g. a Brayton cycle (gas turbine/combustion engine) with a Rankine cycle (steam turbine/boiler), to convert heat loss from the flue-gas of the first cycle to useful energy by subsequent cycle(s).
Combustion optimisation	See Section 10.8.1
Flue-gas condenser	A heat exchanger where water is preheated by the flue-gas before it is heated in the steam condenser. The vapour content in the flue-gas thus condenses as it is cooled by the heating water. The flue-gas condenser is used both to increase the energy efficiency of the combustion unit and to remove pollutants such as dust, SO _x , HCl, and HF from the flue-gas.
Process gas management system	A system that enables the iron and steel process gases that can be used as fuels (e.g. blast furnace, coke oven, basic oxygen furnace gases) to be directed to the combustion plants, depending on the availability of these fuels and on the type of combustion plants in an integrated steelworks.
Supercritical steam conditions	The use of a steam circuit, including steam reheating systems, in which steam can reach pressures above 220.6 bar and temperatures of > 540°C.
Ultra-supercritical steam conditions	The use of a steam circuit, including reheat systems, in which steam can reach pressures above 250–300 bar and temperatures above 580–600 °C.
Wet stack	The design of the stack in order to enable water vapour condensation from the saturated flue-gas and thus to avoid using a flue-gas reheater after the wet FGD.

10.8.3 Techniques to reduce emissions of NO_x and/or CO to air

Technique	Description
Advanced control system	See Section 10.8.1
Air staging	The creation of several combustion zones in the combustion chamber with different oxygen contents for reducing NO _x emissions and ensuring optimised combustion. The technique involves a primary combustion zone with substoichiometric firing (i.e. with deficiency of air) and a second reburn combustion zone (running with excess air) to improve combustion. Some old, small boilers may require a capacity reduction to allow the space for air staging.
Combined techniques for NO _x and SO _x reduction	The use of complex and integrated abatement techniques for combined reduction of NO _x , SO _x and, often, other pollutants from the flue-gas, e.g. activated carbon and DeSONO _x processes. They can be applied either alone or in combination with other primary techniques in coal-fired PC boilers.
Combustion optimisation	See Section 10.8.1
Dry low-NO _x burners (DLN)	Gas turbine burners that include the premixing of the air and fuel before entering the combustion zone. By mixing air and fuel before combustion, a homogeneous temperature distribution and a lower flame temperature are achieved, resulting in lower NO _x emissions.
Flue-gas or exhaust-gas recirculation (FGR/EGR)	Recirculation of part of the flue-gas to the combustion chamber to replace part of the fresh combustion air, with the dual effect of cooling the temperature and limiting the O ₂ content for nitrogen oxidation, thus limiting the NO _x generation. It implies the supply of flue-gas from the furnace into the flame to reduce the oxygen content and therefore the temperature of the flame. The use of special burners or other provisions is based on the internal recirculation of combustion gases which cool the root of the flames and reduce the oxygen content in the hottest part of the flames.
Fuel choice	The use of fuel with a low nitrogen content.
Fuel staging	The technique is based on the reduction of the flame temperature or localised hot spots by the creation of several combustion zones in the combustion chamber with different injection levels of fuel and air. The retrofit may be less efficient in smaller plants than in larger plants.
Lean-burn concept and advanced lean-burn concept	The control of the peak flame temperature through lean-burn conditions is the primary combustion approach to limiting NO _x formation in gas engines. Lean combustion decreases the fuel to air ratio in the zones where NO _x is generated so that the peak flame temperature is less than the stoichiometric adiabatic flame temperature, therefore reducing thermal NO _x formation. The optimisation of this concept is called the 'advanced lean-burn concept'.
Low-NO _x burners (LNB)	The technique (including ultra- or advanced low-NO _x burners) is based on the principles of reducing peak flame temperatures; boiler burners are designed to delay but improve the combustion and increase the heat transfer (increased emissivity of the flame). The air/fuel mixing reduces the availability of oxygen and reduces the peak flame temperature, thus retarding the conversion of fuel-bound nitrogen to NO _x and the formation of thermal NO _x , while maintaining high combustion efficiency. It may be associated with a modified design of the furnace combustion chamber. The design of ultra-low-NO _x burners (ULNBs) includes combustion staging (air/fuel) and firebox gases' recirculation (internal flue-gas recirculation). The performance of the technique may be influenced by the boiler design when retrofitting old plants.
Low-NO _x combustion concept in diesel engines	The technique consists of a combination of internal engine modifications, e.g. combustion and fuel injection optimisation (the very late fuel injection timing in combination with early inlet air valve closing), turbocharging or Miller cycle.
Oxidation catalysts	The use of catalysts (that usually contain precious metals such as palladium or platinum) to oxidise carbon monoxide and unburnt hydrocarbons with oxygen to form CO ₂ and water vapour.

Reduction of the combustion air temperature	The use of combustion air at ambient temperature. The combustion air is not preheated in a regenerative air preheater.
Selective catalytic reduction (SCR)	Selective reduction of nitrogen oxides with ammonia or urea in the presence of a catalyst. The technique is based on the reduction of NO_x to nitrogen in a catalytic bed by reaction with ammonia (in general aqueous solution) at an optimum operating temperature of around 300–450 °C. Several layers of catalyst may be applied. A higher NO_x reduction is achieved with the use of several catalyst layers. The technique design can be modular, and special catalysts and/or preheating can be used to cope with low loads or with a wide flue-gas temperature window. 'In-duct' or 'slip' SCR is a technique that combines SNCR with downstream SCR which reduces the ammonia slip from the SNCR unit.
Selective non-catalytic reduction (SNCR)	Selective reduction of nitrogen oxides with ammonia or urea without a catalyst. The technique is based on the reduction of NO_x to nitrogen by reaction with ammonia or urea at a high temperature. The operating temperature window is maintained between 800 °C and 1 000 °C for optimal reaction.
Water/steam addition	Water or steam is used as a diluent for reducing the combustion temperature in gas turbines, engines or boilers and thus the thermal NO_x formation. It is either premixed with the fuel prior to its combustion (fuel emulsion, humidification or saturation) or directly injected in the combustion chamber (water/steam injection).

10.8.4 Techniques to reduce emissions of SO_x, HCl and/or HF to air

Technique	Description
Boiler sorbent injection (in-furnace or in-bed)	The direct injection of a dry sorbent into the combustion chamber, or the addition of magnesium- or calcium-based adsorbents to the bed of a fluidised bed boiler. The surface of the sorbent particles reacts with the SO ₂ in the flue-gas or in the fluidised bed boiler. It is mostly used in combination with a dust abatement technique.
Circulating fluidised bed (CFB) dry scrubber	Flue-gas from the boiler air preheater enters the CFB absorber at the bottom and flows vertically upwards through a Venturi section where a solid sorbent and water are injected separately into the flue-gas stream. It is mostly used in combination with a dust abatement technique.
Combined techniques for NO _x and SO _x reduction	See Section 10.8.3
Duct sorbent injection (DSI)	The injection and dispersion of a dry powder sorbent in the flue-gas stream. The sorbent (e.g. sodium carbonate, sodium bicarbonate, hydrated lime) reacts with acid gases (e.g. the gaseous sulphur species and HCl) to form a solid which is removed with dust abatement techniques (bag filter or electrostatic precipitator). DSI is mostly used in combination with a bag filter.
Flue-gas condenser	See Section 10.8.2
Fuel choice	The use of a fuel with a low sulphur, chlorine and/or fluorine content
Process gas management system	See Section 10.8.2
Seawater FGD	A specific non-regenerative type of wet scrubbing using the natural alkalinity of the seawater to absorb the acidic compounds in the flue-gas. Generally requires an upstream abatement of dust.
Spray dry absorber (SDA)	A suspension/solution of an alkaline reagent is introduced and dispersed in the flue-gas stream. The material reacts with the gaseous sulphur species to form a solid which is removed with dust abatement techniques (bag filter or electrostatic precipitator). SDA is mostly used in combination with a bag filter.
Wet flue-gas desulphurisation (wet FGD)	Technique or combination of scrubbing techniques by which sulphur oxides are removed from flue-gases through various processes generally involving an alkaline sorbent for capturing gaseous SO ₂ and transforming it into solids. In the wet scrubbing process, gaseous compounds are dissolved in a suitable liquid (water or alkaline solution). Simultaneous removal of solid and gaseous compounds may be achieved. Downstream of the wet scrubber, the flue-gases are saturated with water and separation of the droplets is required before discharging the flue-gases. The liquid resulting from the wet scrubbing is sent to a waste water treatment plant and the insoluble matter is collected by sedimentation or filtration.
Wet scrubbing	Use of a liquid, typically water or an aqueous solution, to capture the acidic compounds from the flue-gas by absorption.

10.8.5 Techniques to reduce emissions to air of dust, metals including mercury, and/or PCDD/F

Technique	Description
Bag filter	Bag or fabric filters are constructed from porous woven or felted fabric through which gases are passed to remove particles. The use of a bag filter requires the selection of a fabric suitable for the characteristics of the flue-gas and the maximum operating temperature.
Boiler sorbent injection (in-furnace or in-bed)	See general description in Section 10.8.4. There are co-benefits in the form of dust and metal emissions reduction.
Carbon sorbent (e.g. activated carbon or halogenated activated carbon) injection in the flue-gas	Mercury and/or PCDD/F adsorption by carbon sorbents, such as (halogenated) activated carbon, with or without chemical treatment. The sorbent injection system can be enhanced by the addition of a supplementary bag filter.
Dry or semi-dry FGD system	See general description of each technique (i.e. spray dry absorber (SDA), duct sorbent injection (DSI), circulating fluidised bed (CFB) dry scrubber) in Section 10.8.4. There are co-benefits in the form of dust and metal emissions reduction.
Electrostatic precipitator (ESP)	Electrostatic precipitators operate such that particles are charged and separated under the influence of an electrical field. Electrostatic precipitators are capable of operating under a wide range of conditions. The abatement efficiency typically depends on the number of fields, the residence time (size), catalyst properties, and upstream particle removal devices. ESPs generally include between two and five fields. The most modern (high-performance) ESPs have up to seven fields.
Fuel choice	The use of a fuel with a low ash or metals (e.g. mercury) content.
Multicyclones	Set of dust control systems, based on centrifugal force, whereby particles are separated from the carrier gas, assembled in one or several enclosures.
Use of halogenated additives in the fuel or injected in the furnace	Addition of halogen compounds (e.g. brominated additives) into the furnace to oxidise elemental mercury into soluble or particulate species, thereby enhancing mercury removal in downstream abatement systems.
Wet flue-gas desulphurisation (wet FGD)	See general description in Section 10.8.4. There are co-benefits in the form of dust and metals emission reduction.

10.8.6 Techniques to reduce emissions to water

Technique	Description
Adsorption on activated carbon	The retention of soluble pollutants on the surface of solid, highly porous particles (the adsorbent). Activated carbon is typically used for the adsorption of organic compounds and mercury.
Aerobic biological treatment	The biological oxidation of dissolved organic pollutants with oxygen using the metabolism of microorganisms. In the presence of dissolved oxygen – injected as air or pure oxygen – the organic components are mineralised into carbon dioxide and water or are transformed into other metabolites and biomass. Under certain conditions, aerobic nitrification also takes place whereby microorganisms oxidise ammonium (NH_4^+) to the intermediate nitrite (NO_2^-), which is then further oxidised to nitrate (NO_3^-).
Anoxic/anaerobic biological treatment	The biological reduction of pollutants using the metabolism of microorganisms (e.g. nitrate (NO_3^-) is reduced to elemental gaseous nitrogen, oxidised species of mercury are reduced to elemental mercury). The anoxic/anaerobic treatment of waste water from the use of wet abatement systems is typically carried out in fixed-film bioreactors using activated carbon as a carrier. The anoxic/anaerobic biological treatment for the removal of mercury is applied in combination with other techniques.
Coagulation and flocculation	Coagulation and flocculation are used to separate suspended solids from waste water and are often carried out in successive steps. Coagulation is carried out by adding coagulants with charges opposite to those of the suspended solids. Flocculation is carried out by adding polymers, so that collisions of microfloc particles cause them to bond thereby producing larger flocs.
Crystallisation	The removal of ionic pollutants from waste water by crystallising them on a seed material such as sand or minerals, in a fluidised bed process
Filtration	The separation of solids from waste water by passing it through a porous medium. It includes different types of techniques, e.g. sand filtration, microfiltration and ultrafiltration.
Flotation	The separation of solid or liquid particles from waste water by attaching them to fine gas bubbles, usually air. The buoyant particles accumulate at the water surface and are collected with skimmers.
Ion exchange	The retention of ionic pollutants from waste water and their replacement by more acceptable ions using an ion exchange resin. The pollutants are temporarily retained and afterwards released into a regeneration or backwashing liquid.
Neutralisation	The adjustment of the pH of the waste water to the neutral pH level (approximately 7) by adding chemicals. Sodium hydroxide (NaOH) or calcium hydroxide ($\text{Ca}(\text{OH})_2$) is generally used to increase the pH whereas sulphuric acid (H_2SO_4), hydrochloric acid (HCl) or carbon dioxide (CO_2) is generally used to decrease the pH. The precipitation of some pollutants may occur during neutralisation.
Oil-water separation	The removal of free oil from waste water by gravity separation using devices such as the American Petroleum Institute separator, a corrugated plate interceptor, or a parallel plate interceptor. Oil-water separation is normally followed by flotation, supported by coagulation/flocculation. In some cases, emulsion breaking may be needed prior to oil-water separation.
Oxidation	The conversion of pollutants by chemical oxidising agents to similar compounds that are less hazardous and/or easier to abate. In the case of waste water from the use of wet abatement systems, air may be used to oxidise sulphite (SO_3^{2-}) to sulphate (SO_4^{2-}).
Precipitation	The conversion of dissolved pollutants into insoluble compounds by adding chemical precipitants. The solid precipitates formed are subsequently separated by sedimentation, flotation or filtration. Typical chemicals used for metal precipitation are lime, dolomite, sodium hydroxide, sodium carbonate, sodium sulphide and organosulphides. Calcium salts (other than lime) are used to precipitate sulphate or fluoride.

Sedimentation	The separation of suspended solids by gravitational settling.
Stripping	The removal of purgeable pollutants (e.g. ammonia) from waste water by contact with a high flow of a gas current in order to transfer them to the gas phase. The pollutants are removed from the stripping gas in a downstream treatment and may potentially be reused.

11 EMERGING TECHNIQUES

11.1 Common processes and techniques for energy generation

11.1.1 High-temperature and -pressure super critical coal plant

Efficiencies of > 50 % can be achieved with steam conditions of 320–330 bar, 630–650 °C live steam and 650–680 °C reheat steam. The European research project Advanced (700 °C) PF Power Plant, with steam conditions of 350/700/720 (bar pressure, °C live and reheat steam), has efficiencies in the range of 52–55 %.

The availability of these plants depends on provision, at a financially acceptable level, of the specific alloys required for the construction materials of a boiler that can operate under these high temperatures and pressures (Section 4.1.6 of [54, UK-TWG 2012]).

11.2 Common technical combustion processes

11.2.1 Techniques to reduce sulphur oxide emissions

11.2.1.1 Bubbling technology

End-of-pipe desulphurisation (wet FGD) systems using bubbling technology (or a combination of bubbling and spray technologies) instead of circulation pumps have been developed by several companies including Alstom, Chiyoda, AE&E and others.

Reported benefits associated with the suppression of recycle pumps, spray nozzles, headers, separate oxidation tanks and thickeners are: compact design while achieving high desulphurisation rates; low capital cost; and reduced power consumption.

These systems are currently implemented in some oil-fired and coal-fired plants
[37, EGTEI 2012]

11.2.2 Combined techniques to reduce sulphur oxide and nitrogen oxide emissions

11.2.2.1 Emerging gas/solid catalytic processes

Some processes which are currently being developed are the 'Parsons Flue-gas Clean-up' process and the 'Lurgi CFB' process. These processes have only been installed on a pilot plant scale and are therefore not presented in this chapter.

11.2.2.2 Alkali injection

This process uses the direct injection of one or more dry sorbents such as sodium bicarbonate into the flue-gas stream. Tests have demonstrated the capability of alkali injection into the furnace, duct or spray dry scrubber, for combined SO₂ and NO_x reduction as well as for the removal of other acid gases (e.g. HCl). The mechanism by which this occurs is not completely understood, but these processes can reduce NO_x significantly. Up to 90 % NO_x reduction has been achieved, depending on factors such as the ratio of SO₂ to NO_x in the flue-gas, the reaction temperature, the granulometry of the sorbent, and the residence time. In addition to the uncertainty regarding the NO_x reduction performance, a problem of alkali injection is that the higher NO₂ concentrations can give a brown-orange colouration to the flue-gas. As this process is still at the demonstration stage, no information on the general performance can be given.

11.2.2.3 Wet scrubber with additives to achieve NO_x removal

These processes are generally based on existing wet scrubbing techniques for the removal of SO₂ (limestone or lime slurries), with additives used to achieve NO_x removal. Additives such as Fe(II), EDTA and yellow phosphorus have been shown to achieve variable NO_x removal efficiencies at the laboratory or pilot plant scale. On a commercial scale, about 10 wet, combined SO₂ and NO_x removal plants have been operated, with unit capacities of 10 000–200 000 m³/h. These processes use ClO₂ or O₃ as an oxidising agent, which is added to the gas, before it is subjected to sodium wet scrubbing to remove 30–80 % of the NO_x and more than 90 % of the SO₂. In addition, more than 95 % of the mercury is removed by sodium scrubbing using NaClO as the additive. These processes are not suitable to treat large volumes of gas because of the high cost of the oxidising agent and of the problems of disposing of waste water containing nitrite and nitrate. Due to the lack of information as to whether this process is

actually applied to a large combustion plant, no information on the general performance can be given.

11.2.3 Techniques to reduce metal emissions

11.2.3.1 Membrane filtration to reduce metals in scrubber waste water

Description

Treatment of waste water from wet scrubbers (furnace flue-gas condensate) with silicon carbide (SiC) ceramic membranes. The technique described is based on the example supplied by LiqTech. [88, Denmark 2013]

Technical description

Membrane filtration with silicon carbide ceramic membranes is an inside-out pressure-driven separation process. The ceramic membranes are operated in the so-called cross-flow mode. Cross-flow filtration is a filtration method in which the feed flow is tangential to the surface of the membrane in order to sweep rejected particles and solutes away. The feed fluid is separated into two product streams, the permeate, which is depleted of the rejected particles, and the retentate (or concentrate), which is enriched in those particles. The ceramic membranes are cleaned using back flush, back pulse and cleaning in place (CIP) and/or chemically enhanced backwash (CEB).

Achieved environmental benefit

The operating cost and environmental impact can be significantly reduced when reusing the treated scrubber water in a closed loop, i.e. the polluted liquid is passed through SiC membranes followed by reverse osmosis membranes. When reusing the treated water, an estimated 80 % reduction in clean water usage can be achieved; waste water discharge and chemical sludge handling, and their associated costs, could also be reduced by 90 %.

Environmental performance and operational data

Results from a power plant in Denmark for the removal of heavy metals in the scrubber waste water stream using SiC membranes are given in the table below.

Table 11.1: Removal of heavy metals and other pollutants from scrubber waste water

	Feed	Permeate	Reduction
Conductivity	118 mS/m	36.5 mS/m	69 %
Arsenic	0.0003 ppm	0.0002 ppm	33 %
Barium	0.033 ppm	0.0097 ppm	71 %
Lead	0.004 ppm	0.0001 ppm	97.5 %
Cadmium*	0.0038 ppm	0.00005 ppm	99 %
Mercury	0.0007 ppm	< 0.00005 ppm	93 %
Nickel	0.0042 ppm	0.0006 ppm	86 %
Chromium	0.0033 ppm	0.001 ppm	70 %
Copper	0.0026 ppm	0.002 ppm	23 %
Manganese	0.103 ppm	0.031 ppm	70 %
Selenium	0.0014 ppm	0.0003 ppm	79 %
Chloride	85 ppm	16 ppm	81 %
Sulphate	210 ppm	43 ppm	80 %
Nitrate	20 ppm	12 ppm	40 %
Sodium	54.7 ppm	18 ppm	67 %
Calcium	42.2 ppm	8.89 ppm	79 %
TOC	0.5 ppm	0.2 ppm	60 %

Cross-media effects

None.

Technical considerations relevant to applicability

The SiC membrane filtration technology can generally be used in waste water streams that require the removal of suspended metals. SiC membranes can handle extreme environments due to their high thermal and chemical resistance.

Economics

Example data for a 25 m³/h SiC membrane-based ultrafiltration plant are presented in the following table.

Table 11.2: Economic parameters for an example SiC membrane ultrafiltration plant

Capacity	25 m ³ /h
Flux per m ²	350–400 LMH
Numbers of SiC membrane elements	10 pcs
Total plant investment costs - Capex	EUR 300 000–400 000
Total running costs – Opex per year	EUR 50 000
Typical water savings (80 %)	20 m ³ /h per hour multiplied by local water price
Typical discharge savings (90 %) – Estimated discharge fee of EUR 3 per m ³	EUR 3 per m ³ /h = 22.5 m ³ h*24*365*EUR 3 = EUR 591 300
Payback time	< 1 year
<i>Source: [88, Denmark 2013]</i>	

Driving force for implementation

- Higher discharge fees for waste water containing heavy metals.
- Reduction of water consumption and reuse of water.
- Replacement of a number of technologies with one filtration step.
- Compliance with new waste water discharge quality standards.

Example plants

- Power plant, Randers, Denmark (Industrial Scale Pilot experiment 2012).
- Power plant, Germany (Industrial Scale Pilot experiment 2013) and ongoing project for full-scale system to be commissioned in 2014.
- Power plant, Germany (Industrial Scale Pilot experiment 2013+2014).

11.2.4 CO₂ capture processes

To reduce the emissions of CO₂ beyond the levels that can be achieved by maximising the thermal efficiency of processes and techniques generating energy, CO₂ emissions from fossil-fuel-fired combustion plants can be captured and then transported and stored underground.

The additional carbon capture plant requires additional energy consumption, e.g. for the heating needed for CO₂ desorption. CO₂ capture processes therefore lead to an efficiency loss estimated at 8–12 percentage points for existing coal-fired power plants. Due to the efficiency drop associated with CO₂ capture, increasing the efficiency of fossil-fuel-fired power plants is the first step. In parallel, improvement of the energy efficiency of CO₂ capture processes and optimisation of the steam cycle for the heat demands of CO₂ capture are priorities. [54, UK-TWG 2012]

The development of CO₂ capture technologies is being pursued by global power plant suppliers in collaboration with utility companies, academia and governments, particularly in Europe, North America and Australia. Several solutions are currently being developed. They are usually classified into post-combustion, oxy-fuel and pre-combustion capture processes: [280, EPPSA 2012]

- Post-combustion processes consist of extracting the CO₂ that is diluted in the combustion flue-gas. Post-combustion is the most advanced technology today. The solvents for CO₂ post-combustion capture can be physical, chemical, or intermediate. Chemical solvents, such as amines, are most likely to be used. Other post-combustion capture solutions are absorption (new solvents, chilled ammonia), adsorption, anti-sublimation, and membranes.
- Oxy-combustion processes consist of burning a fuel in oxygen. The gases produced by the oxy-combustion process are mainly water and CO₂, from which CO₂ can easily be removed at the end of the process.
- Pre-combustion processes involve conversion (gasification or partial oxidation) of fuel into a synthesis gas (carbon monoxide and hydrogen) which is then reacted with steam in a shift reactor to convert CO into CO₂ or another organic substance. The process produces highly concentrated CO₂ that is readily removable by physical absorbents. H₂ can then be burnt in a gas turbine. For the moment, none of the existing coal-fired IGCC plants includes shift conversion with CO₂ capture.

The required CO₂ purity level determines the choice of pollutant abatement techniques. The level and nature of impurities in the CO₂ stream can affect some CO₂ capture processes that are sensitive to pollutants, and can also be important for CO₂ transport and storage. For example, NO₂ and SO₂ from flue-gas react with amines (post-combustion capture) to form stable, non-regenerable salts and so cause a loss of some amines. With amines, the SO₂ specification is usually set as < 40 mg/Nm³ and the NO₂ specification as < 50 mg/Nm³ (based on a daily average, standard conditions and an O₂ level of 6 %. Depending on the chemical solvent used, specifications may be different). Limits for SO_x can be achieved by some FGD technologies. Experience shows that limestone gypsum FGD plants can be designed to reduce SO₂ emissions down to 10 mg/Nm³ with an increase in capital costs of about 7 % and a 27 % increase in

operating costs. Limits for NO_x are technically achievable by the use of low-NO_x burners and SCR.

Other types of CCS technology are available but are not yet mature enough for application in large combustion plants.

CO₂ capture and storage in power plants is now being demonstrated in a few small-scale pilot plants. The first large-scale demonstration plant has been in operation since October 2014 at Unit 3 (a 160 MW coal-fired plant) at the Boundary Dam Power Station at Estevan, Saskatchewan, Canada. With a total plant cost of around CAD 1.5 billion, first financial analyses estimate that the achieved CCS costs are still substantially higher than the 2020 objective of below EUR 25/tonne of CO₂ avoided.

There is no consensus on which option (post-, pre- or oxy-combustion) will be the least costly in the future; each has pros and cons and the costs appear to be comparable. The efficiency penalties of CO₂ capture will become lower for future power plants.

Carbon capture options being considered for coal include pre-combustion coal gasification, oxy-fuel combustion, and post-combustion. A number of post-combustion scrubbing methods are being trialled. [36, EGTEI 2012] [37, EGTEI 2012]

Cross-media effects

Where additional SO₂ abatement is required to achieve the necessary purity of the CO₂ gas stream, this will offset the higher SO₂ emissions resulting from the relatively high efficiency penalty of carbon capture. However, NO_x and dust emissions may be expected to increase by an amount proportional to the fuel penalty for CCS operation. Direct NH₃ emissions can also increase due to degradation of the amines used in post-combustion capture technologies. [317, EEA 2011]

11.2.4.1 Post-combustion CO₂ capture processes

[280, EPPSA 2012]

11.2.4.1.1 Amine Process

In the Amine Process for carbon dioxide capture from power plant-generated flue-gas, the flue-gas is treated with aqueous amine solution, which reacts with CO₂. Raising the temperature reverses the reaction and CO₂ is released. The solution is recycled for reuse. Several pilot plants fitted with the Amine Process have been in operation in recent years. While the following process description assumes application to a coal-fired utility boiler, the Amine Process can be modified, as required, for post-combustion CO₂ removal from many different utility and industrial combustion processes.

A generic schematic of the Amine Process is shown in Figure 11.1.

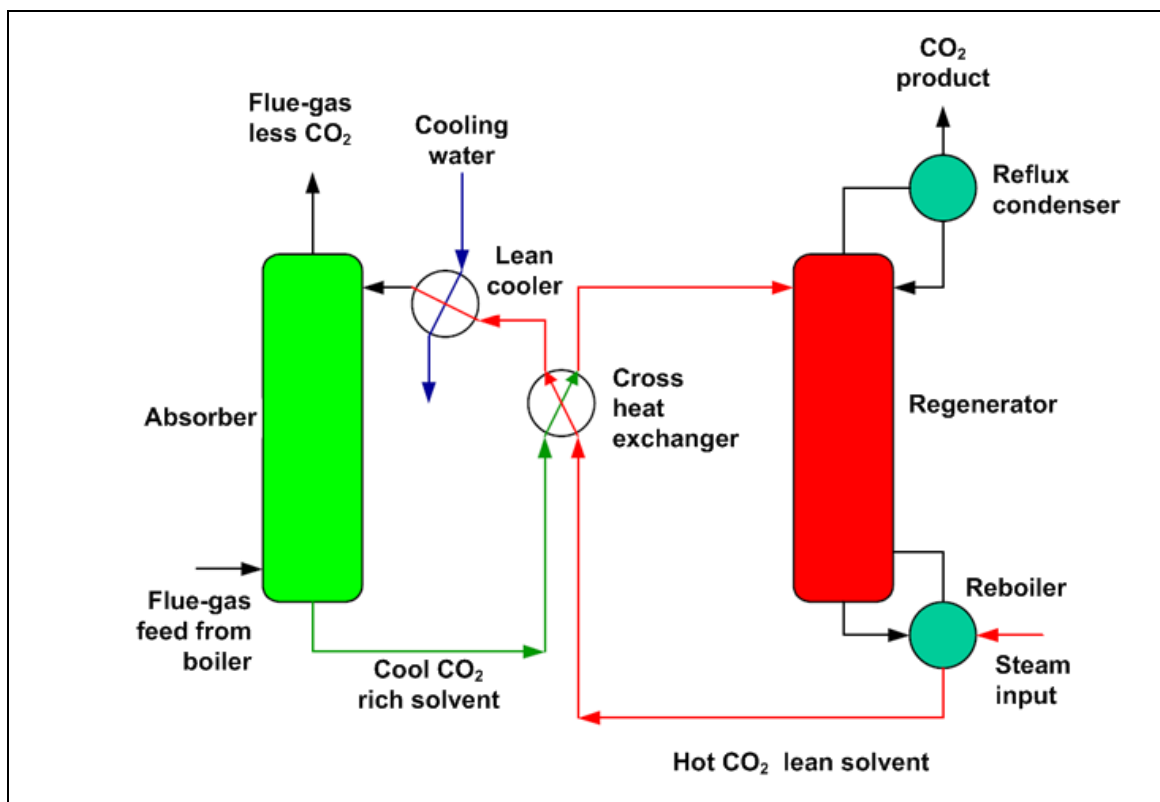

Figure 11.1: Amine Process using UCARSOL™ FGC 3000 (Alstom and Dow Chemical)

The Amine Process is based on the chemistry of the amine-CO₂-H₂O system and the ability of the amine solution to absorb CO₂ at low temperatures and to release the CO₂ at moderately elevated temperatures. CO₂ and water produce carbonic acid to react with amine solution in the absorption column, forming chemical compounds (carbamate or bicarbonate) and resulting in the removal of CO₂ from the gaseous stream. In the example process shown in Figure 11.1, CO₂ is absorbed in an amine solution at a temperature around 50 °C (120 °F) and at atmospheric pressure. The primary absorption reaction is described in ionic form as follows:



R-NH₂ represents the amine used for the process.

The typical target CO₂ removal efficiency is 90 % though efficiencies of up to 99 % could be achieved in well-designed absorbers.

Figure 11.2 shows a simplified flow diagram of a power plant with post-combustion CO₂ capture.

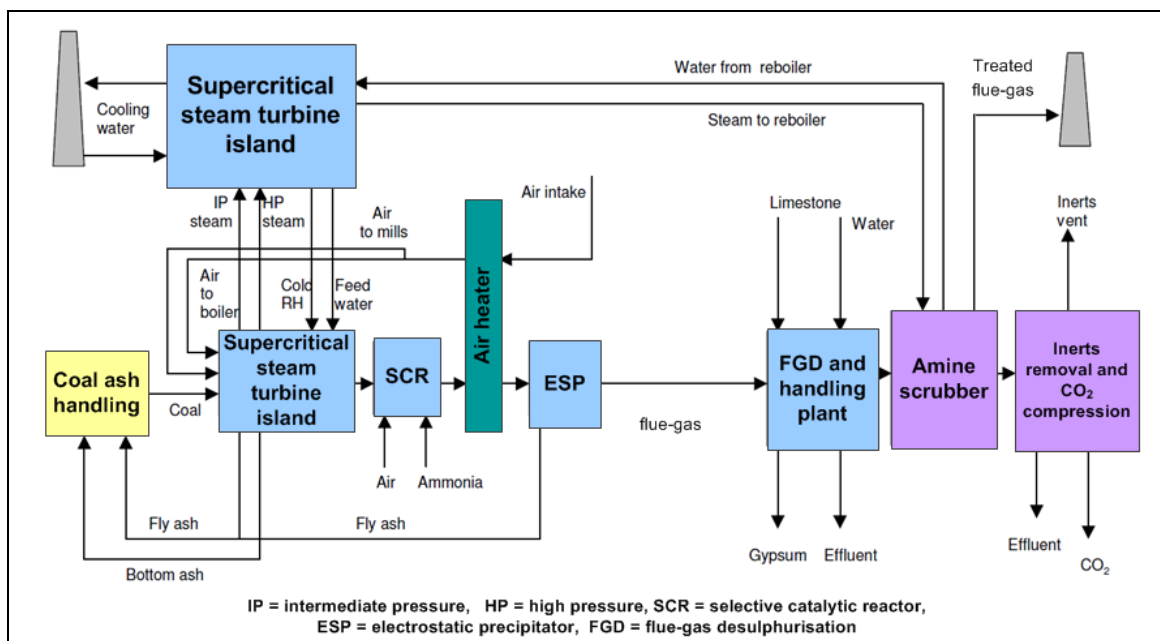

Figure 11.2: Simplified flow diagram of a power plant with post-combustion CO₂ capture

Flue-gas from the boiler is picked up downstream of any installed Air Quality Control System (AQCS) equipment. Concentrations of NO₂ (nitrogen oxide), SO₂, SO₃ (sulphur oxides), HCl, (hydrochloric acid), mercury and particulate matter (PM) need to be kept relatively low to prevent co-absorption and amine solution degradation. SO_x concentrations should ideally be kept below 20 ppmv. NO₂, the portion of NO_x that will react with the amine solution, should be kept below 10 ppmv. Also, the temperature of the flue-gas entering the CO₂ absorber should be below 50 °C (120 °F). Additional AQCS equipment may need to be installed to meet these requirements.

Booster fans overcome the pressure drop associated with the plant vessels and ductwork. Flue-gas is carried to the CO₂ absorption system for treatment and then to the stack for release into the atmosphere. Monitoring equipment (CO₂ analyser) measures the CO₂ contained in the flue-gas entering the CO₂ absorption system as well as the CO₂ level leaving the absorption system. This information determines the absorber efficiency.

The flue-gas leaving the top of the absorber, containing mainly nitrogen, oxygen, water and a low concentration of CO₂, is exhausted to the existing outlet duct. It does not require any reheat under normal conditions.

The CO₂-rich solution exiting the CO₂ absorber contains 3–10 mol % CO₂ in solution. The stream of the rich amine solution from the CO₂ absorber is heated in the rich/lean heat exchangers and sent to the regenerator via one or more feed points. In some processes, half of the feed goes through one exchanger and is sent to the middle of the regenerator.

Regeneration reverses the absorption reactions with the application of heat. The regenerator column contains mass transfer devices (trays or random packing). There, the rich solution flows down the column counter-current to the steam produced by the boiling part of the lean solution exiting the bottom of the regenerator column.

The flow of the lean solution is entirely or partly sent to the regenerator reboiler, where part of the solution (mainly water) is vaporised while providing the energy to remove CO₂ (heat of desorption) from the solution. This steam promotes the dilution necessary for stripping the CO₂ from the rich solution. The remainder of the lean solution that is not vaporised enters the sump of the regenerator column, where it is pumped back to the top of the CO₂ absorber through the rich/lean heat exchangers and the lean solution cooler. The hot lean solution is cooled in the

cross exchangers, and the heat recovered warms the rich solution coming from the CO₂ absorber. The CO₂-loaded steam leaves the top of the regeneration columns after having gone through a high-efficiency mist eliminator to minimise water and amine carry-over.

The CO₂ compression system may involve the use of integrally geared centrifugal compressors with multiple compression stages. The compressors are equipped with intercoolers and after-coolers, where the CO₂ is cooled using condensate from the steam/water cycle as the cooling medium. A CO₂ drying unit is provided to remove moisture from the CO₂ product. Standard drying technologies such as tri-ethylene glycol (TEG) or Molecular Sieve Adsorbers (MSA) are utilised.

Filtration of the amine solution is necessary to reduce the amount of foaming in the absorber column and to keep the amine solution's CO₂ absorption potential at its optimum. The insoluble contaminants can usually be removed by mechanical filtration. Soluble contaminants that are surface-active can be removed to a certain extent by activated carbon filtration. Before entering the CO₂ absorber, a slipstream of 10 % – depending upon the dust load – of the lean solution flows through mechanical cartridge filters and possibly also through an activated carbon filter to reduce impurities in the amine solution. They remove solids from the solvent and carbon fines, which may escape from the carbon bed.

Amine is used in an aqueous solution to selectively capture CO₂ from the flue-gas (gas mixture of N₂, CO₂, O₂ and other trace gases) by chemical absorption in a gas-liquid contact tower (absorber) at relatively low temperatures and CO₂-loaded amine is stripped (chemical desorption) at a relatively higher temperature to separate the CO₂ and to regenerate the amine solution for reuse. In the process, due to the cyclic exposure of the amine to variable process conditions, mainly the temperature, O₂ and traces of strong acid gases, a small fraction of the amine will undergo irreversible chemical change. In the continuous liquid closed-loop process, these trace compounds will accumulate. The purpose of the reclaimer is to separate the active portion of the amine solution from the inactive stable organic salts by-products.

In Norway, the post-combustion amine absorption process has been demonstrated to be able to cope with large and rapid variations in the load of the combustion plant and with start-up/shutdown conditions.

Example pilot plants

South Charleston site, West Virginia (USA). Pilot plant sized for approximately 5 tonnes of CO₂ per day from a side stream from a coal-fired industrial boiler.

C2A2, Le Havre (France). Pilot plant sized for approximately 25 tonnes of CO₂ per day captured from a flue-gas slipstream of 6.5 tonnes per hour from a 600 MW_e coal-fired boiler. The test carbon capture programme was in operation between July 2013 and March 2014.

Maasvlakte (MPP 3) pilot plant Electrabel, E.ON – Hitachi Power Europe (The Netherlands). ~1.1 Mt CO₂ per year foreseen to be captured for a total of 5 Mt of CO₂ over the demonstration phase of the project at a 1 100 MW_e coal-fired plant (250 MW_e equivalent for the carbon capture plant).

11.2.4.1.2 Chilled Ammonia Process

The flue-gas leaving the WFGD system is cooled and sent to the CO₂ absorber, where the CO₂ in the flue-gas reacts with ammonium carbonate to form ammonium bicarbonate (ABC). The flue-gas stream, with most of the CO₂ removed, returns to the existing stack for discharge, and the bleed stream is sent to the plant waste water treatment system for processing. The rich ammonium bicarbonate (ABC) solution is sent to a regenerator column under pressure. Heat is added in the regenerator to separate the CO₂ and return the ammonium carbonate (AC) solution to the CO₂ absorber for reuse. The CO₂ stream is scrubbed to remove excess ammonia, then compressed and transported to the storage system.

The use of the incoming SO_2 and acid gases is effective in the removal of ammonia as 1 mole of SO_2 introduced to DCC2 reacts with 2 moles of NH_3 exiting the water wash to produce ammonium sulphate product.

Depending on the absorber operating temperature and the ammonia concentration in the ionic solution, the treated flue-gas leaving the absorber system contains varying amounts of gaseous ammonia. This ammonia in the flue-gas must be captured and returned to the process in order to minimise ammonia losses from the system, control emissions of ammonia to the environment and maintain stable operating conditions. The water wash NH_3 column is designed to absorb the majority of the incoming ammonia for return to the process.

Rich ammoniated solution is pumped from the absorber to the regenerator through a series of heat exchangers in order to recover heat from the lean ammoniated stream, which is leaving the regenerator bottom. In the regenerator column, as heat is applied, CO_2 evolves from the rich solution. The composition of the vapour stream leaving the regenerator is a function of temperature, pressure, and the relative concentrations of CO_2 , ammonia, and water in the solution.

At moderately elevated temperatures, the vapour pressure of CO_2 in the ammoniated solution increases rapidly while the vapour pressure of the ammonia and water remain relatively low. As a result, the CO_2 is emitted from the regenerator at high pressure, which is a significant feature of the technology. The higher CO_2 product stream pressure significantly reduces the downstream CO_2 compressor power and size. In addition, the CO_2 from the regenerator contains very low concentrations of ammonia (< 50 ppm) and water vapour (< 0.3 mol %), resulting in low overall heat consumption. The CO_2 product stream can be easily washed and cooled to produce an extremely pure CO_2 gas stream.

An ammonia recovery stripper is included to strip ammonia from ammoniated water. A design based on low-pressure ammonia stripping has been recommended based on experience gained in pilot plants.

See the relevant part of Section 11.2.4.11 for a description of the CO_2 compression system.

Example pilot plants

We Energies Pleasant Prairie power plant P4, Wisconsin (USA). The unit, sized to around 15 000 tonnes of CO_2 per year, commenced operations in June 2008.

E.ON Karlshamn Field Validation Unit (Sweden). The pilot unit, designed to capture 15 000 tonnes of CO_2 per year at full capacity, was commissioned in 2009 and operated for approximately 2000 hours, achieving a 90 % capture rate.

AEP Mountaineer Product Validation Facility, West Virginia (USA). 30 MW slipstream from the 1 300 MW plant, equivalent to 0.1 Mt/yr of CO_2 . Between October 2009 and December 2010, 21 000 tonnes CO_2 were captured at a > 90 % capture rate and 15 000 tonnes stored. Process availability reached almost 100 % for both capture and storage.

11.2.4.1.3 Biocatalysis techniques to remove CO_2 from flue-gases

A recent development in the field of carbon capture techniques is the use of enzymes to remove CO_2 from the flue-gases. An example is the proprietary system developed by Akermin, Inc., which incorporates carbonic anhydrase as a biocatalyst to accelerate CO_2 separation by promoting the hydration of CO_2 to bicarbonate at a rate substantially higher than amines. In this system, the problem of low enzyme stability under high pH, temperature and shear forces has been addressed by embedding the enzyme in a thin polymer film in the immediate vicinity of the gas-liquid interface.

Reported benefits of this technique include: low investment costs due to elimination of auxiliary components (e.g. polishing scrubber, direct contact cooler, wash columns, solvent reclaimers);

reduced system footprint; avoidance of solvent emissions; minimal solution replacement requirements; reduced maintenance requirements.

Example pilot plants

Akermin's pilot unit at the National Carbon Capture Center in Wilsonville, AL. This facility was reported in 2013 to have completed 1 600 hours of operation, capturing CO₂ from coal-fired plant flue-gas.

Biofos waste water treatment plant in Copenhagen, Denmark. As first commercial-scale demonstration project of its kind, this plant is set out to remove CO₂ from biogas to produce up to 2.6 million cubic metres of grid-grade bio-methane.

11.2.4.2 Oxy-fuel combustion

Oxy-fuel combustion systems for CO₂ capture are characterised by the burning of coal with relatively pure O₂, diluted with treated or untreated recycled flue-gas. Under these conditions, the primary products of the combustion are water (H₂O) and a high concentration of CO₂. The CO₂ is separated by condensation of the H₂O. Firing with pure oxygen would result in too high a flame temperature, so the mixture is diluted with recycled flue-gas. The recycled flue-gas can also be used to carry fuel into the boiler. Oxy-fuel combustion produces approximately 75 % less flue-gas than air-fired combustion and produces exhaust gas consisting primarily of CO₂ and H₂O. After condensation of the H₂O, the highly concentrated CO₂ is purified and compressed to a liquid or supercritical state, depending on the means of transportation.

An additional purification stage for the highly concentrated CO₂ flue-gas may be necessary to remove other minor gas constituents such as N₂, O₂ and argon, in order to produce a CO₂ stream that meets pipeline and storage requirements. Because of the high CO₂ concentration and reduced gas volume, this purification step should be relatively inexpensive.

The oxy-fuel process is essentially based on the conventional power plant process and uses components which, for the most part, are technically mature. The major additional components are the air separation unit (ASU), the flue-gas condenser and the CO₂ purification and compression systems. The additional design features in the boiler are the flue-gas recirculation and oxygen mixing systems. The materials selected for the different components need to be suitable for the oxygen combustion conditions. The air separation and CO₂ compression systems need additional energy from the power plant and this results in a decrease in its net efficiency. Figure 11.4 shows a flow diagram of an oxy-fuel combustion power plant.

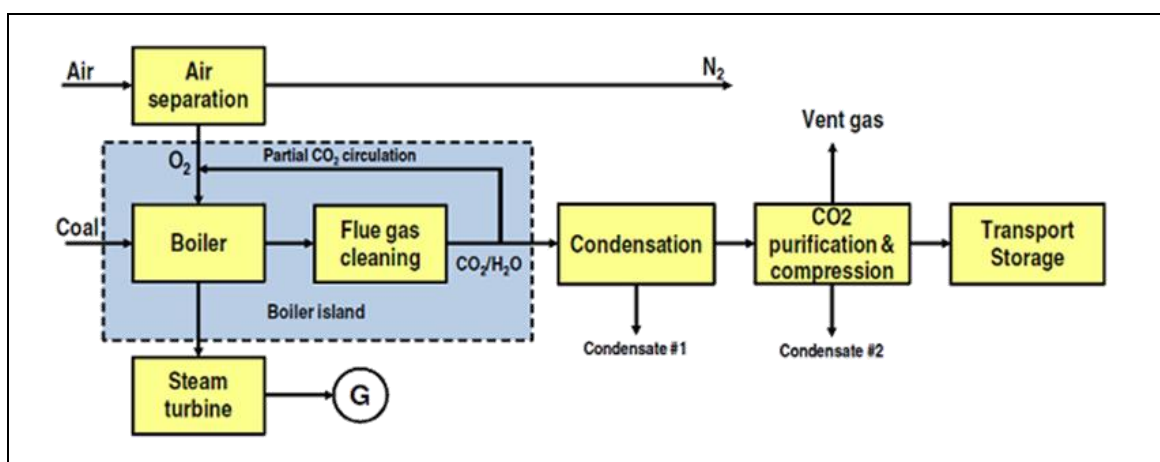

Figure 11.4: Simplified flow diagram of an oxy-fuel power plant

The effects of combustion in O₂/CO₂ atmospheres on the boiler design depend on the selected oxygen concentration in the oxidant: if the O₂ content is about 23–28 % in mass, the air-blown boiler design can be adopted essentially as it is, while, if the O₂ content is higher, the furnace may be smaller.

In an oxy-fuel combustion process, almost all of the N₂ is removed from the air, there resulting in a stream that is approximately 95–97.5 % O₂. Due to the N₂ removal from the air, oxy-fuel combustion produces approximately 75 % less combustion product volume than air-fired combustion. The lower gas volume also allows for flue-gas contaminants (SO_x, NO_x, mercury, particulates) to be more easily removed and at a lower cost. Because N₂ is removed from the air, NO_x production from the boiler is greatly reduced as well.

A first-generation oxy-fuel combustion technology configuration uses a cryogenic process for O₂ separation, atmospheric combustion for fuel conversion, conventional pollution control methods (SO_x, NO_x, mercury, particulates), and mechanical compression for CO₂ pressurisation. The first-generation configuration can be used for retrofitting existing power plants without major modification but requires considerable extra space to accommodate the additional components.

In an advanced second-generation oxy-fuel combustion configuration, cryogenic air separation may be replaced by other technologies, e.g. the chemical looping process, in which oxygen is transferred from the air to the fuel through an oxygen carrier. However, such technologies are in early development stages and will not be applicable to new plants before 2020 and perhaps not to the existing fleet. Second-generation oxy-fuel combustion will probably operate with higher concentrations of oxygen, thus increasing the challenges but also increasing overall plant efficiency and decreasing boiler size.

The Air Quality Control Systems (AQCS) required for the oxy-combustion process are not different from the systems used for conventional steam power plants, i.e. dust removal system, DeNO_x system, if required by the plant operation (operation in dual mode or partial load in air), and DeSO_x system. The dust removal system could be either an ESP or a baghouse system and both dry and wet systems could be considered for the DeSO_x. The flue-gas condenser (FGC) is positioned after the AQCS to remove water vapour and produce a CO₂-rich stream, which meets the requirements of the gas processing unit. This equipment is more specific to the oxy-combustion chain and often not present in a conventional power plant.

In the condenser, the flue-gas is cooled by cooling water, either directly or indirectly. The condensed water is collected at the bottom of the FGC for further treatment. Some of the condensate is used for the quenching process and is pumped to the top of the condenser where it is distributed to the flue-gas. The condensation is followed by absorption of traces of acid gases not captured in the preceding DeSO_x unit. A sodium hydroxide solution may be added to the quench water to neutralise the captured acids.

Example pilot plants

Windsor boiler simulation facility, Connecticut (USA). 15 MW_{th} oxy-fuel pulverised coal boiler.

Schwarze Pumpe (Germany). 30 MW_{th} oxy-fuel pulverised coal boiler.

Lacq (France). 30 MW_{th} gas fired boiler.

CIUDEN (Spain). 30 MW_{th} oxy-CFB coal-fired boiler.

Basis for calculation of emissions from an oxy-fuel power plant

If CO₂ is removed from the flue-gas stream the overall volume of the flue-gas released to the atmosphere is reduced; however, metrics for emissions still link limit values for classic pollutants (notably NO_x, SO_x, CO and particulates) to flue-gas volumes (mg/Nm³) in Europe and therefore need to be reconsidered. The expression of the emission levels based on the volumetric unit of flue-gas can conveniently be applied to normal combustion processes in air firing. When the fuels are burnt with air, the exact composition of the air is known, containing

mainly O₂ (20.95 vol-%) and N₂ (78.09 vol-%). Due to the high concentration of nitrogen in the air, flue-gas CO₂ concentrations are typically 3–15 vol-% (dry basis) depending on the fuel and the combustion technology.

When the combustion is carried out without air, the nitrogen from air does not dilute the emission concentrations in the flue-gases. This means that emission concentrations from the boiler are typically much higher in oxygen firing than in air firing. However, the oxy-fuel flue-gases from the boiler are released directly to the atmosphere only if some occasional, short-term, interruption of the CPU (compression and purification unit) or CO₂ transportation line prevents the reception of CO₂ and it does not make sense to shut down the ASU and switch the boiler to air combustion. In case of a longer interruption of the CCS system, either both the boiler and the ASU will be shut down or, if the boiler is designed to be capable of operating with air combustion as well, it can continue producing power.

In normal CCS operation, all the flue-gas from the oxy-combustion process are led to the CPU and no emissions to air from the boiler itself are anticipated. Instead, inert (non-condensable) gases in the CO₂ stream to the CPU are separated and vented during the CO₂ purification and compression. However, the mass flow rates of emission compounds (SO_x, NO_x, CO, etc.) to the atmosphere from the carbon capture unit are much lower than in air firing.

Given the above, the emission levels based on the concentrations and volumetric units are not applicable to the CCS processes. The CCS processes may produce high concentrations of emission compounds with small gas flow rates to be released into the atmosphere.

CCS processes can produce small amounts of vent gases (despite the capture technology), which may have high concentrations of emissions exceeding the current concentration-based limits. However, the emissions are significantly lower than those produced by air-fired boilers (e.g. if compared on an annual basis). Therefore, emission levels in CCS applications could conveniently be expressed on an energy basis, e.g. as milligrams per megajoule (mg/MJ) or milligrams per megawatt hour (mg/MWh). [280, EPPSA 2012]

11.2.4.3 Carbon Capture Readiness

Although carbon capture readiness is not an emerging technique per se, it is linked to the emerging CCS techniques.

Following the provisions laid down in Directive 2009/31/EC (CCS Directive), Article 36 of the IED establishes the carbon capture readiness legal requirement for all plants of > 300MW_e that meet the necessary conditions in terms of: availability of suitable storage sites; technical and economic feasibility of transport facilities; and technical and economic feasibility of retrofitting for CO₂ capture.

A carbon capture ready (CCR) plant is a plant which can include CO₂ capture when the necessary regulatory or economic drivers are in place. The aim of building plants that are capture ready is to reduce the risk of stranded assets and 'carbon lock-in'. Developers of CCR plants should take responsibility for ensuring that all known factors in their control that would prevent installation and operation of CO₂ capture have been identified and eliminated.

In the UK formal criteria have been laid down, requiring that all new power stations of > 300 MW_e should only be consented to if they can be considered CCR [54, UK-TWG 2012]. The CCR requirements proposed in 2009 by the UK Department of Energy and Climate Change include demonstration:

- that sufficient space is available on or near the site to accommodate carbon capture equipment in the future;

- that retrofitting the chosen carbon capture technology is technically feasible;
- of the likelihood that linking to a full CCS chain including retrofitting of capture equipment will be economically feasible within the power station's lifetime.

If granted consent, operators of the power station will subsequently be required to:

- ensure that control over the space required for the installation of the carbon capture equipment is retained;
- periodically report as to whether it remains technically feasible to retrofit the power station until the plant moves to retrofit CCS, as CCS technology evolves and modifications may be introduced to the plant configuration.

11.2.4.3.1 Plant space and access requirements

Space would need to be provided for the CO₂ capture equipment (scrubbers, CO₂ compressors, oxygen production plant, etc.) and additional infrastructure including cooling water and electrical systems, safety barrier zones, pipework and tie-ins to existing equipment. Further space may be needed during construction, for storage of equipment and materials and for access to the existing plant.

Retrofitting CO₂ capture would reduce the net power output: if the net power output from the site had to be maintained, space would also have to be provided for construction of an additional power generation plant.

11.2.4.3.2 Power plant CCR pre-investments

Further pre-investments can be made to reduce the cost and downtime for the retrofit of CO₂ capture. Some potential CCR pre-investments apply to all technologies, including oversizing pipe-racks and making provision for expansion of the plant control system and on-site electrical distribution. These pre-investments could be relatively attractive, as they are generally low-cost but could result in significant reductions in the costs and downtime for the retrofit. Other potential pre-investments apply to specific capture technologies, as outlined below.

Pulverised coal plants with post-combustion capture

The main areas of the plant which will be affected by the retrofitting of CO₂ capture are the flue-gas treatment unit and the steam turbine and its ancillaries. The feed gas to post-combustion CO₂ scrubbers needs to have low SO_x and NO₂ concentrations to minimise degradation of current (and probably future) solvents. If the power plant is to be built without FGD, provision should be made to add a suitable FGD system when CO₂ capture is retrofitted. If the plant is to be built with FGD, either the FGD system should be designed to meet the flue-gas purity requirements of CO₂ capture or provision should be made to upgrade the FGD performance in future.

Using current post-combustion amine scrubbing technology, about 40–50 % of the low-pressure steam has to be extracted from the steam turbine, for use in the amine regenerator reboiler. There are various ways in which the steam turbine could be designed to minimise the penalties associated with retrofitting this steam extraction and to allow for future changes in extraction levels. After capture retrofit, more low-grade heat would be available for boiler feed-water preheating. This has some impacts on the steam turbine and condensate preheating equipment, which should be taken into account in a CCR design.

Pre-investment in a high-efficiency ultra-supercritical steam cycle would minimise the quantity of CO₂ that would have to be captured, transported and stored per kWh of electricity. This

investment would have the added benefit of reducing CO₂ emissions even before the CCR retrofit.

Pulverised coal oxy-combustion plants

Leakage of air into the boiler and its ancillaries should be minimised, to avoid contamination of the CO₂ product. Air ducts and fans should be designed to enable them to be reused for flue-gas recycling after the plant has been converted to oxy-combustion. FGD may or may not be needed after conversion to oxy-combustion, depending on the plant design and the sulphur content of the fuel. If it is intended to use FGD after conversion to oxy-combustion, the FGD plant should be designed so that it could be adapted to the different gas flows and compositions. Modification of the steam cycle to utilise additional low-grade heat and pre-investment in an ultra-supercritical steam cycle, as mentioned above for post-combustion capture, also apply to oxy-combustion.

Integrated gasification combined-cycle plants with pre-combustion capture

Retrofit of CO₂ capture to an IGCC plant would involve the addition of shift converters, modification of the acid gas removal plant to enable it to also separate CO₂, conversion of the gas turbines to hydrogen combustion and some changes to the steam system. The shift conversion reaction is exothermic, which reduces the overall heat of combustion of the fuel gas.

To avoid having to operate the gas turbine at a reduced load after the capture retrofit, which would be an efficiency and cost penalty, provision could be made for increasing the capacity of the gasification plant, oxygen production plant and other ancillary plants. The intention to retrofit CO₂ capture could also have implications for the choice of gasifier and gas turbine.

Natural gas combined-cycle plants

Natural gas combined-cycle plants could be retrofitted with pre- or post-combustion capture. For post-combustion capture, steam would need to be extracted from the steam turbine, as described above for a coal-fired plant. For pre-combustion capture, natural gas partial oxidation, shift conversion and CO₂ separation plants would need to be retrofitted, the gas turbine would have to be converted to hydrogen combustion and the HRSG and steam turbine would have to cope with the resulting changes in flue-gas flow rate, composition and temperature. All of these issues should be taken into account in a capture ready plant design.

11.3 Gasification / Liquefaction / Pyrolysis of fuels

Table 11.3 summarises a number of gasification technologies that have been or are being developed by various organisations in several countries.

Table 11.3: Gasification technologies

Technology name	Gasifier type	Owner and location	Current status and size	Notes
British Gas/Lurgi (BGL)	Moving-bed slagging	Envirotherm (Germany), Allied Technologies (US)	12 ft diameter unit with coal and wastes (now shut down)	Offered commercially for ~1 000 t/day
Econo Power International Corporation (EPIC)	Two-stage fixed-bed – air-blown, atmospheric pressure	EPIC (US)	Widely used in China. Typical size 3.6m diameter, 250 MMBtu/h of fuel gas	Two gasifiers ordered for Homeland, IA
EAGLE	Dry feed two-stage entrained	JPower (Japan)	Test programme on 150 t/day pilot	170 MW IGCC planned for 2016
Aerojet Rocketdyne	Dry feed single stage downflow entrained	Aerojet Rocketdyne (US)	Conceptual. Pilot gasifier at GTI 2009	Larger units planned in China, US and Colombia
HT Winkler	Circulating fluidised bed	Uhde (Germany)	25 bar 150 mtpd pilot operated in 1990s. 10 bar 800 t/day unit ran 1985-1994	Future development uncertain
KRW	Bubbling fluidised bed	KBR (US)	800 t/day unit for 100 MW IGCC. Did not run successfully	Future development unlikely
SES (GTI U Gas)	Fluidised bed GTI	Exclusive license to SES (2006)	4x100 t/day gasifiers at 4 bar in Shanghai. 25 bar PDU at GTI	Additional gasifiers to be supplied to China
HRL IDGCC (Integrated Drying Gasification Combined Cycle)	Circulating fluidised bed	Research Labs (HRL) (Australia)	Test programme on 10 MW unit (1997-8)	400 MW IDGCC planned in Latrobe Valley
BHEL	Fluidised bed	BHEL (India)	30 mtpd pilot plant	130 MW IGCC planned in South India
GreatPoint Energy - bluegas™	Catalytic fluidised bed	GreatPoint Energy (US)	Pilot tests at GTI. Funding obtained for larger unit	Several projects planned in China and US
Hydromax	Molten metal (iron and tin)	Alchemix (Arizona, US)	0.3 m batch unit at CSIRO, Australia	Cyclic process. Licensed to Diversified Energy, AZ
Pyreoneer	Low-temperature CFB gasification	DONG Energy Power (Denmark)	6 MW fuel-flexible gasification plant at Asnæs Power Station in Kalundborg suitable for gasification of straw, manure fibre, energy crops, etc.	The gas is very clean, due to the low gasification temperature and can be fed directly to the coal boiler

Coal- and multi-fuel-based IGCC

- TPRI (Thermal Power Research Institute) has developed a dry coal-fed two-stage entrained gasifier that is to be used in the GreenGen IGCC project in China. A successful demonstration of their gasification technologies at a commercial size is needed before they can really be considered as offering IGCC plants with the necessary guarantees.
- Siemens' 500 MW_{th} gasifiers have a coal capacity of about 1 800 tonnes per day. In 2009, Siemens proposed a larger 1 200 MW_{th} gasifier. Both gasification and power block islands can be offered.
- KBR/Southern Company has formed an alliance based on the KBR Transport gasification technology. Henceforth this will be referred to as the TRIG™ technology. A successful demonstration of their gasification technologies at a commercial size is needed before they can really be considered as offering IGCC plants with the necessary guarantees.
- ECUST (the East China University of Science & Technology) has developed its own version of a slurry-fed downflow entrained gasifier; 13 commercial projects have been initiated in China and it is now offered internationally.

BHEL (India) Fluidised Bed

The BHEL gasifier is air-blown and gasification tests on the 30 mtpd pilot plant with Singareni coal (40 % ash) showed a carbon conversion of 88–89 % and a cold gas efficiency of 68.8 % with a syngas LHV of 1050 kcal/Nm³. BHEL plans a 125 MW fluidised bed IGCC project with Andra Pradesh Genco at Vijaywada in South India. A similar project with NTPC at Auraiya in North India was also discussed, but NTPC and BHEL could not agree on terms and NTPC is now planning to proceed on its own with an IGCC project and will appoint a consultant to prepare a design specification.

GreatPoint Energy

GreatPoint Energy (GPE) is a start-up company based in Massachusetts that plans on commercialising a proprietary catalytic gasification process, bluegas™, for converting coal and petroleum coke to SNG without the use of oxygen. It appears to be largely derived from the Exxon Catalytic Gasification process piloted briefly in the 1980s. A small unit has been tested at the GTI flexible test facility in Des Plaines, IL for ~1 200 hours. A 1–3 stpd pilot plant is planned to be built at Dominion's Brayton Point power station in Massachusetts. There are also plans for a later scale-up to 40–50 stpd.

The Exxon Catalytic process was tested in a Process Development Unit of 1 mtpd size. The process adds 10–15 % potassium carbonate to the coal in a bubbling fluidised bed gasifier, which allows the gasification, water gas shift and methanation reactions to proceed in a single vessel at the same temperature. Some of the issues to be addressed in further development of the Exxon technology are:

- high usage of potassium carbonate;
- reliable and inexpensive catalyst recovery;
- gasifier scale-up;
- avoidance of agglomeration in the gasifier;
- high syngas recycle rate;
- economic heat recovery for the recycled syngas.

Hydromax molten metal gasification

Hydromax is a cyclic process using gasification in a molten metal (an alloy of iron and tin) bath. The process envisages the use of two or more molten metal bath smelters operated in a cyclical way. The coal mineral matter forms a slag layer in the bath that must be periodically removed. The two parts of the cyclic process are the reaction of steam and oxygen with iron to produce hydrogen and iron oxide and the reduction of the iron oxide back to elemental iron, with the production of syngas.

Entrained-flow gasifier improvements

The main improvements to entrained-flow gasifiers are summarised in this section.

Slurry-fed gasifiers (GE/Texaco, E Gas, ECUST) have the advantage of being able to pump the feed at high pressures. The energy used for pumping is lower than the energy used to compress the conveying gas. Some schemes have been suggested to use slurry pumping to attain high pressures and with additional flash drying to give a dry coal feed with the flashed steam readded to the syngas downstream of the gasifier to provide the syngas moisture for the shift reaction. Another alternative is to feed the coal as a coal in liquid CO₂ slurry either with or without a flash drying step. Such improvements could be particularly advantageous for the abundant, and low-cost, low rank coals such as Powder River Basin (PRB) sub-bituminous coals.

Pratt & Whitney Rocketdyne (PWR), with financial and technical assistance from ExxonMobil and DOE, are also developing their own version of a solids feed pump for high-pressure entrained gasifiers.

For the GE/Texaco process, the most important developments are to improve the carbon conversion per pass (possibly in conjunction with a new improved feed system, and/or larger volume gasifiers to allow more residence time) and a continuous slag let-down system to eliminate the lock hoppers. The replacement of the carbon scrubber by a warm or hot gas filter could markedly reduce the O&M costs associated with the black and grey water circuits around the scrubber and would improve plant availability. Use of a cooled screen instead of a refractory lining for the gasifier could also reduce forced outages and improve availability.

The development of the ECUST technology in China, with its four horizontally opposed injectors in a downflow configuration represents a potential improvement on the single downflow injector technology of GE and Siemens. It should improve carbon conversion by avoiding the direct feed trajectory into the gasifier outlet.

A higher pressure E Gas gasifier with tall cylindrical design, the ESTR (entrained slagging transport) has been proposed. However, more recently it was suggested that the current inverted T (sometimes called the iron cross) design can, after all, be adapted to larger sizes and somewhat higher pressures. This will improve the performance for low rank coals and could enable lower cost CO₂ capture through use of a physical absorption system such as Selexol. Although methane is produced from the second stage feed, the two-stage gasifiers could be run with only a minor amount of coal slurry fed to the second stage and with additional water as the quench water to achieve the lower outlet temperature and to produce a syngas of a low methane and high moisture content consistent with the needs for hydrogen, high CO₂ capture and for synthesis applications. Operating in this manner could also eliminate the need for a syngas cooler. It may be noted that E-Gas already incorporates a continuous slag removal process and a hot gas filter into their process.

The IEA GHG R&D sponsored study with Foster Wheeler Italiana showed that dry coal-fed entrained gasifiers such as those of Shell and Siemens become more expensive and less efficient at high pressures if the lock hopper pneumatic conveying feed systems is used. Higher pressures require more conveying nitrogen per unit of coal fed. A truly continuous high-pressure coal feeder, preferably on as-received coal or minimally dried coal, would be a marked improvement. However, a conveying gas would still be required to move the pressurised coal into the gasifier injectors. In CO₂ capture and synthesis applications, the syngas is shifted and some of the CO₂ is removed. This captured CO₂ can then also be used as the conveying gas for the feed coal, reducing the inert gas in the downstream clean-up and synthesis, and perhaps improving the economics. These organisations could also potentially use their dry coal feed expertise to adopt something like a pumped slurry flash system as feed at high pressure. Shell currently uses an expensive syngas cooler in their solid fuel gasification process; however, for CO₂ capture, hydrogen production and synthesis, in 2007 they offered a lower cost partial quench system. The Shell process already incorporates a cooling screen (water wall) and a hot gas filter but would benefit from a continuous slag removal system.

The EAGLE gasifier is an oxygen-blown, dry coal-fed, two-stage upflow entrained-flow reactor with a membrane wall. A 150 mt/day pilot plant gasifier was built at the Wakamatsu Research Facility of JPower (formerly the Electric Power Development Corporation (EPDC)) in Japan. A typical gas composition has been reported as ~55 % CO, ~24 % hydrogen and ~18 % nitrogen (the high nitrogen content is to be expected because of the relatively small size and the use of nitrogen in instrument purges etc.). An update from JPower and Chugoku announced the formation of a joint venture for their IGCC project at Chugoku's Osaki station in Hiroshima and an increase from the original 150 MW to 170 MW. This project is to include CCS. Initial operations are targeted for late 2016. Testing of shift catalysts and physical solvents for CO₂ capture are continuing at the EAGLE pilot gasifier.

Economy of scale

Larger gasifiers would result in significant economic improvements in most marketplace applications. Furthermore, future trends in the marketplace, as listed below, all point to the need for larger gasifiers to match the fuel requirements of the downstream equipment in a rational multi-train manner:

- the more efficient gas turbines from various suppliers, with higher pressure ratios and firing temperatures, will have higher fuel requirements when adapted to IGCC;
- the 50 Hz IGCC market requires gasifiers sized to meet the fuel needs of gas turbines which are ~1.4 times those needed for the equivalent 60 Hz turbines;
- economy of scale is very important for all applications including the Coal-to-Liquids technology using Fischer Tropsch, methanol or EMRE MTG synthesis.

Advanced concept power blocks

Some advanced concepts could potentially capture CO₂ from the power block exhaust flue-gas. For such concepts there would be no limit on the acceptable fuel components (e.g. methane) in the syngas.

The oxygen-fired rocket engine proposed by Clean Energy Systems could be fired with clean syngas of any composition and, after condensing the moisture, would result in a concentrated CO₂ exhaust stream that could be dried and compressed for transportation and sequestration. A 5 MW demonstration unit has been tested near Bakersfield, California with support from the US DOE and Siemens. A larger unit of ~50 MW may be used in Phase 3 of the WESTCARB sequestration partnership to provide CO₂ for a substantial sequestration injection project in the San Joaquin Basin.

Siemens has been developing a Solid Oxide Fuel Cell (SOFC) that incorporates an oxidising function (similar to the Oxygen Transfer Membranes (OTM) being developed by Air Products and Praxair under the DOE programme) for completing the combustion of the anode gas to CO₂ and moisture. The SOFC could potentially be supplied with clean syngas of any composition (providing it was clean enough) and the resultant exhaust stream could be dried and compressed for transportation and sequestration. A 250 kW SOFC with this OTM feature has been supplied by Siemens to Shell Hydrogen at a Norwegian location. However, there has been little recent news about this test unit.

Biomass gasification

Low-temperature CFB gasification: Pyroneer

DONG Energy has recently developed and commissioned a 6 MW fuel-flexible gasification plant at Asnæs Power Station in Kalundborg suitable for gasification of straw, manure fibre, energy crops, etc. The Pyroneer gasification technology has been developed with the purpose of being able to co-fire large amounts of high-alkaline biomass fractions in coal-fired boilers. Biomass fractions, such as straw, willow and miscanthus, contain large amounts of alkaline which tends to corrode the current high-efficiency supercritical boiler technologies and

deactivate the catalytic DeNO_x cleaning systems. Furthermore, the direct co-firing technology tends to ‘destroy’ the alkaline and nutrients in the biomass, and hence these useful species cannot easily be reused as a fertiliser as they are mixed with the coal fly ash. If biomass is gasified at a suitably low temperature, the troublesome alkaline species can be maintained in a solid state. It can then be separated from the created gas by a cyclone, and instead of causing corrosion in the boiler, it can be reused as a fertiliser product.

The latest version of this technology can split biomass and waste fractions into a clean, combustible gas and a useful fertiliser product. It is expected that it will be possible to remove around 90 % of the alkaline present in the biomass, and hence it will be possible to obtain relatively high biomass to coal ratios in the boiler without operating at a reduced steam temperature and reduced efficiency. The technology allows 1 GJ of biomass to replace 0.95 GJ of coal. The intention is to further upscale the technology to 50–150 MW. DONG Energy was expected to commission a 50 MW gasifier in 2015.

Furthermore, the technology has the potential to be equipped with a hot gas filter, and thus the produced gas could be used in gas-fired applications. The gasifier can also be pressurised and used in various configurations that could deliver synthesis gas for further processing in gas turbines or in the production of liquid fuels and chemicals.

The gas is very clean, due to the low gasification temperature, and can be fed directly to the coal boiler. Maximum operating temperatures are 700–750 °C. A drawback of the low-temperature CFB process is that it produces gas with a high tar content.

'Güssing' technology (Vienna University of Technology)

This technology involves a fluidised bed and steam for gasification (fast internal circulating fluidised bed).

The Güssing plant (Austria) is a commercial operation producing electricity and district heating for the surrounding area, but the plant is also the core of an energy research centre focusing on gasification techniques with an array of related pilot projects, for example SNG and methanol production, FT processing, and the use of solid oxide fuel cells (SOFC). [293, Brandin et al. 2011]

The plant uses steam gasification and is indirectly heated by hot bed material from an external riser. The gasifier can be described as being of BFB design with an internally circulating bed. Part of the main BFB, containing unconverted char, is moved over to the raiser where it meets air as the raiser medium. The char is combusted during transportation to the top of the raiser, heating the entrained bed material in the process. At the top of the raiser, the hot solid bed material is separated in a cyclone and returned to the BFB, while the flue-gas goes to the stack. The plant uses wood chips as biofuel.

The plant has a total thermal input of 8 MW_{th}, and produces 2 MW_e of electric power and 4.5 MW_{th} of district heating. The biomass-to-electricity efficiency is 25 % and the overall efficiency is 81 %.

GoBiGas project (Sweden)

This project for 20 MW SNG production is at the commissioning stage. The GoBiGas plant is projected as a 100 MW_{SNG} twin-bed FICFB (Fast Internally Circulating Fluidised Bed) with *cogeneration of biofuels and district heating* – and includes the possibility to lead some of the gas to a gas engine or gas turbine for production of electricity and heat.

MELINA and OLGA (ECN, the Netherlands)

Similar to the Güssing process, this has been especially developed for SNG production. OLGA is a tar removal technology. A conversion efficiency of 70 % for biomass to SNG has been proposed.

Updraught gasification

This is carried out in the Harboøre updraught gasifier with a gas engine. Tar from the gas is collected and used in a boiler. The process uses Babcock & Wilcox Vølund technology, and exports to Italy and Japan. The technology is at the commercial stage but plant sizes are small.

Staged gasification

Viking and WEISS Hadsund use a two-stage downdraught gasifier. Drying and pyrolysis of the biomass fuel, gasification of the char, and cracking of the tar result in a very clean gas that can be used in gas engines. The technology is at the commercial stage but only in small plants of $< 1 \text{ MW}_e$.

11.3.1 IGCC (Integrated gasification combined cycle)

See general description in Chapter 4.

IGCC plants present a significant advantage for CO_2 scrubbing compared to other thermal electricity-generating processes thanks to low actual volume flows due to lower mole flows and higher pressure levels. In combination with moderately high CO_2 levels, this leads to small column sizes and high partial CO_2 pressure.

Several companies and institutions carry out research under US DOE programmes for an optimised low- NO_x combined-cycle combustion without secondary NO_x abatement (namely SCR), by controlling the CO shift reaction. By controlling this reaction, gas quality can be normalised and gas diluted for flame temperature control, and desired levels of energy density targeted – the main determinants for NO_x formation in downstream combustion. The catalyst bed is fed with a fuel-rich fuel/gas mixture and cooled indirectly by the remaining combustion air, which mixes further downstream for turbine combustion.

It is thought that IGCC could in future reach 50 % efficiency (LHV basis).

[36, EGTEI 2012] [37, EGTEI 2012]

11.3.2 Underground coal gasification

Underground coal gasification (and power generation) underwent tests and trials in the former USSR, China, Europe and the USA before the year 2000. More recently, pilot-scale tests were carried out in Australia, Canada, China and South Africa and have been proposed in additional countries including the UK, Poland, Ukraine, China, Russia and the USA.

Underground coal gasification (UCG) involves reacting (burning) coal in situ/in seam, using a mixture of air/oxygen, possibly with some steam, to produce a syngas. The steam may come from water which leaks into the underground cavity, from water already in the coal seam or from steam deliberately injected. Some coal combustion generates enough heat to support the process reactions. Gasification at elevated temperatures with a stoichiometric shortage of oxygen principally produces the gases hydrogen and carbon monoxide, combined with many other products including carbon dioxide, hydrocarbons such as methane, tars, and compounds such as hydrogen sulphide and carbonyl sulphide (COS) arising from impurities in the coal.

The syngas produced is cleaned and can be used in a combustion plant or as a chemicals/liquid fuels feedstock. UCG offers the potential for using the energy stored in coal in an economic and environmentally sensitive way, particularly from deposits which are unmineable by conventional methods. If UCG were to be successfully developed and widely deployed, then the world's coal reserves might be revised upwards by a substantial amount. Site selection of the places where UCG could be carried out is critical to any development as the geology must be appropriate.

Several technologies have been trialled at different scales up to the industrial scale. While certain principles, methodologies and monitoring techniques have been established, the results have not yet been such as to allow considering UCG a commercially proven technique.

Early in 2009, the UK Coal Authority awarded the first licence in the UK to win coal by using UCG. In the licence granted, the initial target horizons are unworked coal seams from 500 m to 3 500 m deep. [285, Couch 2009]

11.4 Combustion of solid fuels

11.4.1 Combustion of coal and/or lignite

11.4.1.1 Pilot plant for pre-drying of lignite with low-temperature heat

The technology of pre-drying lignite is expected to lead to an increase in the efficiency of lignite plants of about 4 to 5 percentage points, in theory. The aim of the technique is to dry the lignite, which arrives wet directly from the opencast mine, with low-temperature heat of about 120 °C to 150 °C, instead of hot flue-gas at 1 000 °C. Furthermore, the aim is that the energy required to evaporate the water content of the lignite will be regained by condensing the vapour. Two different processes are available for this.

One, mechanical-thermal dewatering, is currently under development. The pilot plant for this process produces 12 tonnes of dry lignite per hour, at a water content of approximately 22 %. The lignite is heated up and squeezed at 60 bar and 200 °C in order to separate the water, and is reheated again.

The second process for drying the lignite is already at a later stage of development. It involves drying the lignite in a fluidised bed apparatus with internal utilisation of the waste heat. The steam dissipating from the dryer is separated from its contents of lignite particles by an electrostatic precipitator. Afterwards, it is compacted again by a compressor, which works in an open heat pump process, and is finally condensed inside the pipe coils, which are used as heating surfaces in the dryer. The condensation heat is thereby transmitted into the fluidised bed to dry the lignite. Part of the dedusted steam is used to fluidise the lignite and is fed into the apparatus by a ventilator. A pilot plant of this technology produces 90 tonnes of dry lignite per hour, at a water content of 12 %. Both processes are shown in Figure 11.5.

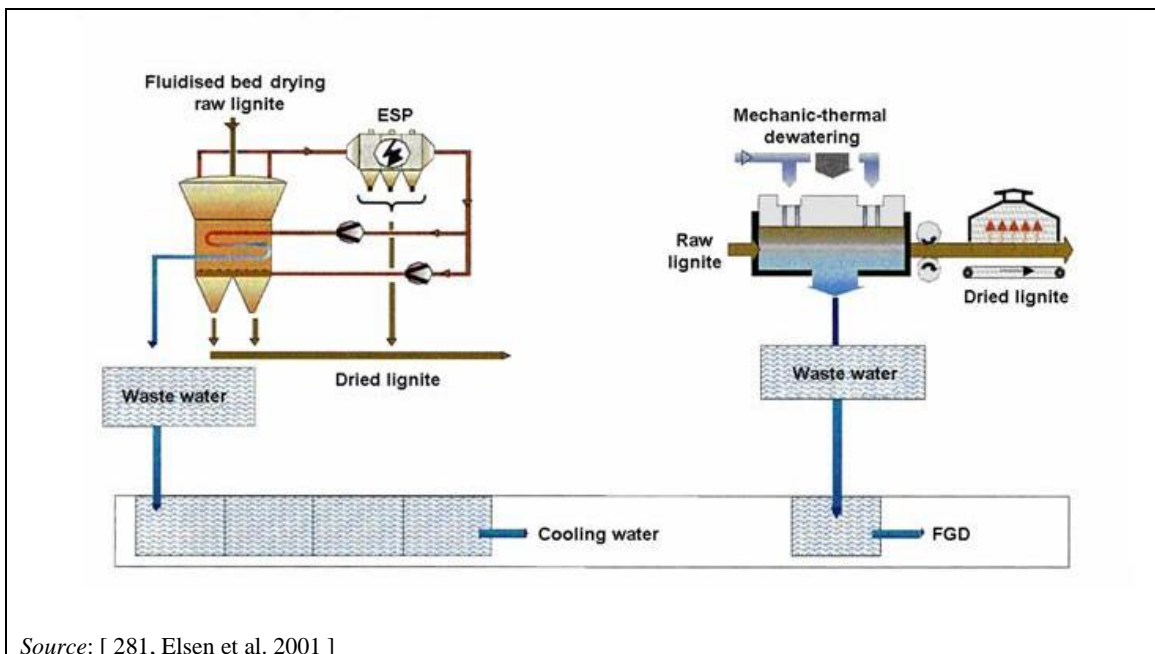

Source: [281, Elsen et al., 2001]

Figure 11.5: Pilot plant for lignite drying

A recent implementation of the second process is the WTA (Wirbelschicht-Trocknung mit interner Abwärmenutzung, fluidised bed drying with internal waste heat utilisation) technology developed by RWE. The energy needed for drying is injected via heat exchangers integrated into the fluidised bed dryer and heated with steam. Drying occurs in virtually 100 % pure, slightly superheated water vapour. With a system pressure of approximately 1.1 bar and a

fluidised bed temperature of 110 °C, the residual moisture content is in the order of 12 % in the case of Rhenish lignite.

The WTA prototype plant at Niederaußem is the world's largest lignite-drying system with an input of 210 tonnes of raw lignite per hour and a water evaporation of 100 tonnes per hour. [282, EPPSA 2012]

11.4.1.2 Mercury emissions reduction

11.4.1.2.1 Coal beneficiation

Coal beneficiation is an emerging technique for coal preparation that improves coal properties beyond what can be achieved with coal washing alone. It includes coal washing as a primary step, but then uses additional treatment to reduce the mercury content of the coal. An example is the K-Fuel process, which is actually a pre-combustion multi-pollutant control process, as in addition to reducing mercury emissions it also lowers PM, SO₂ and NO_x emissions. The beneficiated coal can be derived from bituminous or sub-bituminous coals or lignite. The resulting fuel is lower in ash, higher in heating value, and produces lower pollutant emissions than untreated coal.

It is a two-step process, as shown in Figure 11.6.

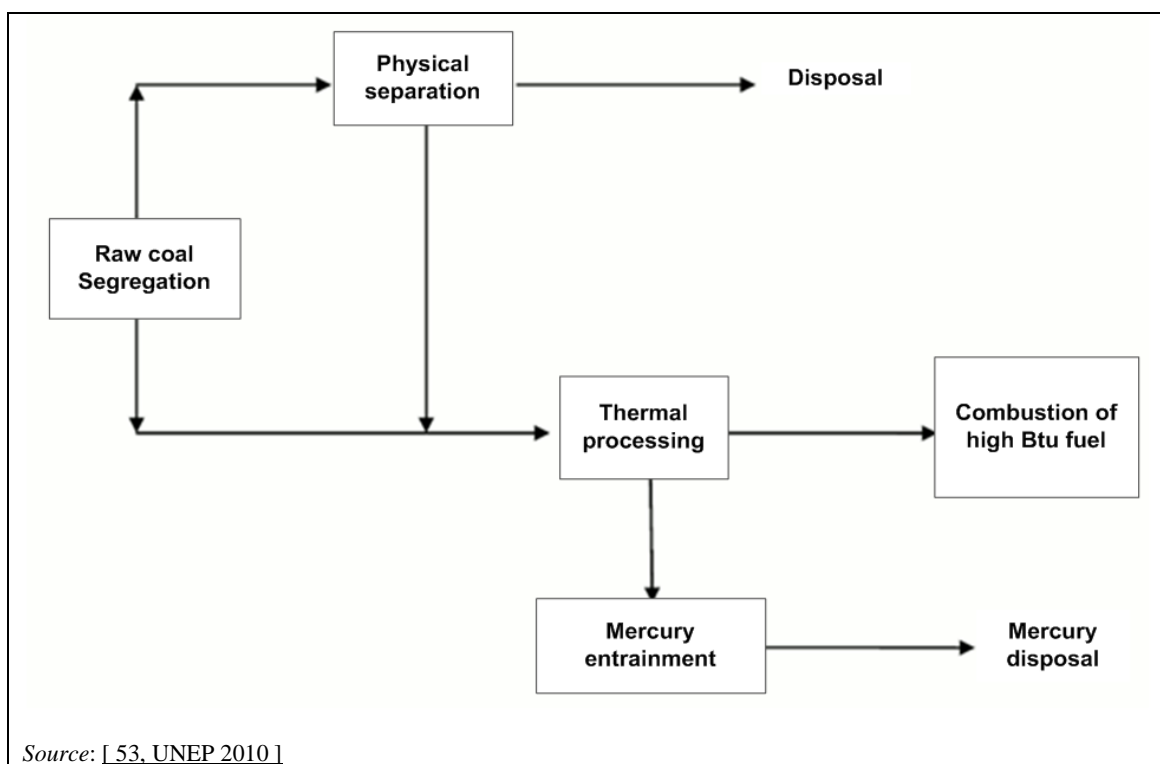

Figure 11.6: Presentation of the coal beneficiation K-Fuel process

The two steps are:

- physical separation: a gravity separation process, either wet or dry, is used to remove ash along with other pollutants;
- thermal processing: following physical separation, this employs thermal processing vessels operating at high temperature and pressure (240 °C and 340 kPa).

Demonstration projects have shown mercury reductions of up to 70 % with the K-Fuel process, and 28–66 % reductions on a number of low rank coals. SO₂ and NO_x emission reductions have been up to 40 % and 46 % respectively, although this varies with coal types.

Because of the limited operational experience, there is currently no adequate information to estimate the price of the processed coal. In the future, the price for K-Fuel may be based on the price of a competing coal on a heating value basis plus credits for environmental benefits (SO₂, NO_x and mercury emissions reduction).

11.4.1.2.2 Oxidation catalysts

Oxidation catalysts can be in the form of powdered chemicals injected into either the boiler or the boiler's exhaust gas, to help change elemental mercury into oxidised mercury, which is easier to capture. The oxidation of elemental mercury, which is then collected by particulate control devices or absorbed across a wet scrubber system, has the potential to be a reliable and cost-effective mercury control strategy for some coal-fired power plants.

The US DOE cites examples of oxidation catalysts tested at operating power plants, including the following:

- URS Corporation tested oxidation catalysts at a plant that fires a blend of Texas lignite and sub-bituminous coals. Tests completed in April 2005 showed that oxidation catalysts enabled the wet scrubber to achieve mercury emissions reduction ranging from 76 % to 87 %, compared with only a 36 % reduction under baseline conditions.
- URS also tested oxidation catalysts at a boiler firing low-sulphur eastern bituminous coal equipped with a cold-side ESP. This seven-year programme tested gold- and platinum-based oxidation catalysts and was completed by the end of 2010, and evidenced several experimental limitations.

Parameters under scrutiny were the following: amount of catalyst required to achieve high mercury oxidation percentages, catalyst life, and efficiency of mercury capture.

There are also oxidation catalysts with fixed, active layers on a metal or ceramic supporting structure. Tests are being done with an additional Hg catalyst layer in DeNO_x catalysts.

[2, EEB 2012] [38, US-GAO 2009]

11.4.1.2.3 Other novel control technologies

The 'Thief Process' was patented by the NETL of the US DOE and licensed to Nalco Mobotec. It may be a cost-effective alternative to sorbent injection. Some preliminary cost assessments made by the NETL and published in 2006 indicate levelised cost savings that would be approximately 50 % of the levelised cost of a conventional activated carbon injection system. No commercial-stage applications of the technique have been identified.

On the basis of this 'Thief Process', the NETL recently (2012) patented a 'Thief carbon catalyst' for the oxidation of mercury in power plant effluent streams generated from industrial sources including coal-fired power plants. The active component of the catalyst is the partially combusted coal, termed 'Thief' carbon, which can be pretreated with a halide or left untreated in the presence of an effluent gas entrained with a halide. It is stated that this catalyst has the dual advantages of high mercury oxidation levels and high adsorption levels for halides or halide-containing compounds. This technology would have the advantages of a longer catalyst life and concurrent lower long-term costs. [2, EEB 2012] [38, US-GAO 2009]

11.4.1.2.4 Photochemical oxidation process

Photochemical oxidation is a patented process that introduces an ultraviolet light into the exhaust gas to help convert mercury to an oxidised form for collection in other pollution control devices.

[2, EEB 2012] [38, US-GAO 2009]

11.4.1.3 Multi-pollutant control technologies

The following are currently emerging multi-pollutant control technologies:

- The Regenerative Activated Coke Technology (ReACT™) system developed, tested and commercialised by Hamon Research-Cottrel (HRC) consists of activated coke in a moving bed with regeneration of the coke before return to the adsorber with sulphuric acid as a by-product. Removal efficiencies of > 90 % for SO₂ and mercury and > 20 % for NO_x are claimed; the particulate matter concentration would be also reduced by 50 %.

In August 2013, HRC announced it had received full notice to proceed with the engineering, procurement and installation of a ReACT™ system at a 320 MW_e unit in a Wisconsin power plant burning PRB coal. The estimated cost of this project was USD 250 million.

- The US company Eco Power Solutions developed, tested and commercialised a system using an ozone injection process for NO_x conversion. A fogging spray is mixed with a hydrogen peroxide solution for SO_x conversion that is condensed concurrently with other pollutants over coils to remove all combustion emissions from the exhaust gas stream. This process converts NO_x and SO_x to nitric and sulphuric acid in the waste water stream collected at the bottom of the unit. Simultaneously unburnt hydrocarbons and particulate matter are removed during the condensation phase along with carbonic acid resulting from dissolved CO₂. This waste water can then be treated and recycled.

Removal efficiencies of > 99 % and > 98 % are claimed for SO_x and NO_x respectively as well as high removal efficiencies for mercury, arsenic, nickel and particulate matter (> 95 %). HCl would also be removed with a high efficiency and CO₂ would be also partly captured (30–50 %). This system's capital costs are claimed to be 25 % lower than the alternatives' and the cost per tonne of emissions reduction would be 20–40 % lower than traditional technologies'. Another advantage is that this technology could be installed and running in 30 months.

- The Israel-based company Lextran developed and commercialised a process in which absorption is realised by reacting SO₂ and NO_x with a proprietary catalyst in a wet scrubber environment process, replacing the lime emulsion. The Lextran catalyst is an organic substance in an emulsion form which contains an active sulphur-oxygen functional group, with catalytic properties which enhance the oxidation reactions of SO_x and NO_x into SO₄ and NO₃ anions. After facilitating the initial oxidation, the Lextran catalyst is released and recycled back into the process, leaving the pollutants in a chemical form suitable to become commercially beneficial by-products (fertilisers) with further neutralisation by ammonia, KOH or other basic reagents to control the type of by-product. The possible by-products are therefore mainly ammonium nitrate, ammonium sulphate, potassium sulphate, potassium nitrate and others.

Tests have shown that Lextran's technology would be capable of removing up to 99 % of SO_x and up to 90 % of NO_x. A study conducted by the Electric Power Research Institute suggests that a 500 MW boiler using this technology could save an estimated 40 % in combined capital and operating costs over 10 years compared to baseline pollution control methods.

11.5 Combustion of liquid fuels

11.5.1 Combustion of liquid petroleum commercial fuels in boilers / engines / turbines

11.5.1.1 Two-stage turbocharging for large internal combustion engines

A combination of the Miller cycle (early inlet valve closure timings before bottom dead centre (BDC)) and high-pressure turbocharging is used to reduce emissions of NO_x and, at the same time, lower fuel consumption and CO_2 emissions while achieving higher power density (increased unit output). In recent years, two-stage turbocharging has found its first applications in the field of automotive and high-speed engines. For large stationary engines, this concept is currently at the demonstration stage due to the increased complexity.

The Miller concept has been introduced in steps in large medium-speed engines to overcome the trade-off between thermal NO_x formation and fuel consumption. In the bigger engines, for a possible future extreme Miller concept, a single stage turbocharger is not enough and two-stage turbocharging will be needed.

Prototype testing under lab conditions have shown the potential to reduce NO_x by 60 % while simultaneously reducing fuel consumption by up to 3 %. However, there remain numerous technical difficulties to be overcome before large two-stage turbocharged medium-speed diesel engines are broadly in use.

In particular, where the combination with SCR would be needed to further reduce NO_x emissions, in the case of sulphur-containing fuels the exhaust temperature after the turbine of the second turbocharger would be too low to avoid condensation of ammonium bisulphate, so the SCR equipment would need to be inserted between the turbines of the first and the second turbochargers, which affects the transient behaviour of the engine.

As a consequence, further R&D work and extensive testing are needed before the concept with the combined SCR and Miller two-stage turbocharging can be commercially released.

[287, EUROMOT 2012]

11.5.2 Fuel cell applications

Fuel cell applications are expected to be a future energy technique for clean liquid fuels. They may offer improvements in environmental protection and are expected to lead to higher energy efficiencies (possibly by up to 70 %). Proof of the stability of operation for a qualified lifetime is required before they can be broadly applied. At the moment, the size of the pilot plants is small compared to LCPs.

11.6 Combustion of gaseous fuels

11.6.1 Combustion of natural gas in boilers / engines / turbines

11.6.1.1 Miller cycle and two-stage turbocharging in lean-burn gas engines

For a general description of the combination of the Miller cycle and two-stage turbocharging, see Section 6.1.4.2 under combustion of liquid fuels.

The lean-burn-type gas engines' Otto cycle results in substantially reduced NO_x production; nevertheless, the maximum cycle temperature is a limiting factor for the mean effective pressure and efficiency due to the knock effect. The Miller cycle allows a considerably reduced combustion temperature and consequently enables higher compression ratios, higher firing pressures and higher mean effective pressures.

Laboratory tests have shown similar efficiency increases as in diesel engine tests. However, the tests have shown an increased methane slip due to the higher cylinder pressure. As a consequence, primary techniques in use today to reduce total hydrocarbon emissions in gas engines will have to be further developed to maintain the methane slip levels achieved by gas engines currently on the market. In order to further reduce methane slips with the two-stage turbocharger concept, the development of viable suitable secondary abatement methods may be needed (see Section 11.6.1.2). [287, EUROMOT 2012]

11.6.1.2 Methane slip development from gas-fired lean-burn engines

Since the beginning of the 1990s primary in-engine measures have been used to reduce hydrocarbon emissions while maintaining low NO_x levels. Tests have shown that there is further hydrocarbon reduction potential in primary measures, but there are limiting factors that do not allow for the total avoidance of unburnt fuel.

Around the middle of the 1990s the development of secondary methane abatement techniques started. This on-going work has resulted in the development of several concepts but also evidenced a number of technical problems that are yet to be solved. Different secondary abatement options have been explored, including the use of an oxidation catalyst, the plasma process, afterburners and recuperative thermal oxidisers. While the plasma process and afterburner are not further described due to the high energy penalty, the other two processes are outlined below. [286, EUROMOT 2012]

11.6.1.2.1 Oxidation catalyst

Tests with oxidation catalysts in the context of lean-burn engines have shown that, due to methane's higher ignition temperature compared with CO or other hydrocarbons, the exhaust temperature in the order of 400–450 °C is too low for effective CH_4 abatement and should be raised by at least about 200 °C.

In order to reach the required temperature level, the oxidation catalyst could be placed in the flue-gas stream before the turbocharger or by use of regenerative heat exchangers behind the turbocharger. While the latter option affects the dynamics and performance of the engine substantially, the former does not but does represent increased engineering challenges.

An additional challenge evidenced by the tests has been the fast degradation of catalyst activity, requiring the development of a regeneration scheme. The high costs of noble-metal-based oxidation catalysts also contribute to the remaining challenges to the commercial viability of the product.

11.6.1.2.2 Recuperative oxidiser

The functional principle of recuperative oxidisers is based on an internal bed (typically sand or ceramic material) that is heated up to 800 °C, allowing the ignition of CH₄. The internal bed stores heat the heat released by the destruction of CH₄ and sometimes is also heated by an extra heat source. The exhaust flow direction in/out of the reactor is switched at intervals to keep as much heat as possible in the bed. The heat of the bed is continuously transported towards the outlet of the bed by the exhaust gas. The flue-gas entering the inlet of the reactor is heated by the bed and the hydrocarbon content is ignited in the middle of the bed. In order to compensate for the high pressure drop caused by the internal bed, an extra flue-gas fan might be needed.

Recuperative reactors offer high THC and CH₄ reductions, but are large in size and capital-intensive. They also require constant operation and thus are not suitable for interrupted operation mode applications such as peak load plants.

11.6.1.3 Oxy-combustion

Oxy-combustion enables the capture of CO₂ by direct compression of the flue-gas without further chemical capture or separation. Optimisation of the competitiveness of the oxy-combustion process for power generation requires several developments:

- adaptation of cryogenic air separation units for more energy-efficient utilisation and operability for use in large oxy-fuel burners;
- power plants or development of new oxy-combustion technologies, such as chemical looping combustion;
- adaptation of combustion technologies to oxygen firing;
- safe operation under enhanced oxygen firing and carbon dioxide-related safety issues;
- optimisation of heat transfer in the boiler;
- optimisation of the steam cycle in order to compensate efficiency loss due to CCS;
- optimisation of flue-gas recirculation.

Several 10–50 MW_{th} demonstration plants were planned worldwide up to 2010, with 100–500 MW_{th} demonstration units possible by around 2015. Oxy-combustion technologies could be commercially available around 2020.

The reduction of NO_x emissions (on a mass emissions basis) in oxy-combustion processes is mainly due to the very low concentration of N₂ from air in the combustor. The decrease in NO_x formation is then the result of the recirculation of flue-gas (and due to interactions between the recycled NO_x, fuel-nitrogen and hydrocarbons released from the fuel). [36, EGTEI 2012]

11.6.1.4 Catalytic combustion

Catalytic combustion is a technology that combusts fuel flamelessly. This process releases the same amount of energy as flame-based combustion systems but at a lower peak temperature. Importantly, this lower temperature is below the threshold at which NO_x is formed. This is achieved by combustion on a palladium-based catalytic surface. As the temperature range in which the catalyst is active is limited, both at the low end (not enough activity) and at the high end (degradation), the combustion process consists of three stages:

- **Pre-combustion:** An integrated pre-burner raises the temperature of the incoming gas/air mixture to the required value for the catalyst to become active. This applies mainly in low load situations. Typically only a small portion of the fuel is used in the pre-burner.
- **Catalytic combustion:** Catalytic combustion takes place at relatively low temperatures, thus inhibiting NO_x formation. Not all the fuel is burnt here, as this would raise the temperature of the catalyst too much, thus degrading the catalyst.
- **Homogeneous combustion:** The rest of the fuel is burnt under lean fuel conditions. No flame instability occurs, as the inlet temperature of this zone is already fairly high because of the upstream catalytic combustion.

Catalytic combustor technology, which is a very promising technology, is just entering commercial service in the US. Information provided by manufacturers is based generally on 'demonstrated in practice' installations. Catalytic combustion has been demonstrated only at a pilot scale on a 1.5 MW_e gas turbine. Plans for application on a 170 MW_e gas turbine are being developed. NO_x levels of less than 10 mg/Nm³ are expected with the use of this technique.

11.6.1.5 Flameless combustion

Description

Flameless combustion is achieved by dilution of reactants through a strong recirculation of burnt gases and aims at combusting gases at temperatures above self-ignition temperatures (~850 °C), achieving simultaneously very low NO_x emissions and a high heating efficiency. The name 'flameless combustion' comes from the fact there is no visible flame in high-temperature furnaces (see Figure 11.7). In that configuration, radiative heat fluxes from the wall prevent the front flame from being observed.



Figure 11.7: Typical picture of combustion obtained with a flameless burner

Traditional low-NO_x burners for boilers:

- may produce high CO emissions;
- do not allow for high thermal load modulation ranges;
- require high air ratios (reducing the energy efficiency of the boiler);
- may produce long flames that may damage the boiler.

The flameless combustion regime can address these issues.

Conventional burners can maintain combustion stability by flame stability. Hence, conventional burners lead to large temperature gradients resulting in high NO_x formation rates in hot zones. The state of flameless combustion can be obtained by different means. One route, already commercialised for high air inlet temperatures (industrial furnaces), is based on an increase in recirculation rates to high recirculation ratios in order to maintain stable combustion. Indeed, for recirculation rates above a certain ratio ($K_v > 3$ (Milani and Wüning, 2001)), the high injection momentum of the fuel-air mixture keeps the combustion stable provided that auto-ignition is secured at the reactant mix point. Simultaneously, high levels of dilution induced by high recirculation rates minimise the temperature gradient as well as fluctuations in the combustion chamber.

Achieved environmental benefits

Reduction of NO_x emissions.

Environmental performance and operational data

NO_x concentrations lower than 50 mg/Nm³ (at 3 % O₂), without any external FGR or secondary NO_x abatement techniques.

Status of implementation

The concept of flameless combustion was introduced in the 1980s and the 1990s for industrial furnace applications (e.g. glass furnaces) where temperatures are significantly higher (> 1 000 °C) than the ones found in combustion plants.

Research activities (CANOE project) have been carried out since 2010 by CRIGEN (ENGIE, formerly GDF Suez) in association with CORIA (Université de Rouen / INSA Rouen) and Ecole Centrale de Paris, in order to transfer the concept to boilers. These activities have been based on computer simulations, lab-scale and semi-industrial-scale pilot tests (including flame stability, modelling tools development, 'flame' detection for safety issues, cost estimations, etc.) with a focus on gas-fired boilers (fire tubes and water tubes) where temperatures are lower than 1 000 °C.

As of 2015, a design has been validated on a 1 MW_{th} fire tube boiler. Results have shown that NO_x emissions lower than 50 mg/Nm³ (at 3 % O₂) can be obtained over the whole thermal load range.

Additional tests at a full demonstration scale (5 MW_{th}) are expected in 2016 and commercial burners within the 10–500 MW_{th} range are expected by 2018.

Economics and applicability

Retrofits are the main target for industrial natural-gas-fired boilers (simple burner change and minimal boiler modifications), although new plants can also benefit from this technology. The economic impact of flameless combustion is based on a high heating efficiency, a long boiler lifetime and low operational costs.

Driving force for implementation

- Achievement of low NO_x concentrations without secondary NO_x abatement techniques.
- High modulation range.
- Short flame.

Reference literature

[318, Ourliac et al. 2015] [319, Ourliac et al. 2015] [320, Stierlin et al. 2011] [321, Stierlin 2011] [322, Villiermaux et al. 2008] [323, Levy et al. 2004] [324, Milani et al. 2002] [325, Milani et al. 2002]

11.6.1.6 Closed-loop steam cooling

Another advanced gas turbine development is the use of steam cooling instead of air cooling in combined-cycle gas turbines (CCGTs). Usually, extracted air from the gas turbine compressor is used for the cooling of the turbine shaft and blading. The amount of cooling air is up to 20–25 % of the compressor airflow. The extracted air is not available for the combustion process and loses pressure when flowing through the narrow channels in the turbine blades, which causes efficiency losses in the gas turbine process. By using steam instead of compressed air, these disadvantages are eliminated. Steam cooling is more efficient than air cooling.

In the turbines mentioned above, a closed-loop steam cooling system is applied. Steam cools the hot components, such as turbine blades, vanes, or transition pieces. The used steam is not mixed with the main gas flow through the gas turbine (as in an open system), but is routed back to the steam system, where it can be expanded as reheat steam through the steam turbine. The steam for the cooling is extracted from the exhaust section of the high-pressure steam turbine. The steam is reheated to the reheat temperature and then mixed with the reheated steam from the heat recovery steam generator (HRSG), and led to the intermediate-pressure section of the steam turbine for further expansion. The cooling steam does not affect the main flow through the gas turbine and, in principle, there should be no consumption of water. Closed-loop steam cooling has some disadvantages in CCGTs operating in flexible mode.

By applying steam cooling, the turbine inlet temperature is increased without any relevant increase in combustion temperature. As a result, a higher efficiency is obtained without an increase in NO_x emissions. Cooling by steam instead of air strongly reduces the air bled from the compressor, the compressed air, and thus the power consumption of the compressor. This also results in higher gas turbine efficiency and in a specific emissions reduction.

With this new cooling technology, a combined-cycle efficiency improvement of one or two percentage points can be achieved and an efficiency of 60 % can be expected. Several system manufacturers have developed CCGT technology exceeding 58 % efficiency in commercial operation, but none of them reached 60 %. Efficiency is expected to rise in the coming years up to 62 %.

Example plants

Although the concept is still undergoing further development, the closed-loop cooling system is already applied in commercial systems such as GE's 'H' series of CCGTs. Example plants are:

- the Baglan Bay CCGT in the UK;
- TEPCO's Futtsu 4 1 520 MW_e site in Japan;
- the Inland Empire CCGT site in Southern California.

[55, EEB 2012]

11.6.1.7 Further development potential

Some further important potential improvements include:

- improving the materials and cooling to enable turbine inlet temperatures of 1 500 °C for frame-type gas turbines and 1 700 °C for aeroderivative gas turbines to be achieved;
- reducing the amount of compressed air used for the cooling medium;
- cooling the blades with external cooling flow (water or steam);
- in the future, generally using single crystal blades;

- improving the temperature profile at the turbine inlet; without hot spots, the general temperature can be set just below the temperature limit given by the material. [123, Eurelectric 2001]

11.6.1.8 Recuperative options

There are several options to recover the exhaust gas heat into the gas turbine process. This section describes some of these features.

11.6.1.8.1 Intercooled recuperated gas turbine

A large part of the power that is generated by the turbine is required to drive the compressor. A way to improve the gas turbine efficiency is to reduce the compressor work by cooling the airflow through the compressor. The compressor power is proportional to the volume flow. Theoretically, cooling after each compressor stage will give the largest reduction of compressor work, however in practice only a restrictive number of cooling stages is feasible.

If the temperature of the gas turbine exhaust gas is higher than the outlet air temperature of the compressor, it is possible to transfer some of the heat from the exhaust gas to the compressor outlet air. This improves the gas turbine efficiency because less fuel is required to heat the gas to the desired turbine inlet temperature. This kind of recuperation can mainly be used for gas turbines with a moderate compression ratio or for gas turbines with intercooled compressors.

Designs incorporating the application of both compressor intercooling and recuperation as described can reach an efficiency of 54 %, calculated at a turbine inlet temperature of 1 200 °C. [123, Eurelectric 2001]

11.6.1.8.2 HAT cycle

In the humidified air turbine (HAT) cycle, humidification of the compressed air after the air compressor allows the compressed air temperature to be decreased. In the HAT cycle, all the air is saturated with water vapour utilising waste heat from compressor intercoolers and from the gas turbine exhaust. With this cycle, a higher possible amount of regenerated heat from the exhaust gases can be used than with an intercooled and recuperation process. The difficulty with this cycle is that standard gas turbines cannot be used for the process, as the mass flow through the turbine is increased too much through the saturation of all the compressor air with water. The high content of water vapour in the combustion air might also create problems for the burners, although with this process a lower compressor ratio results in a higher efficiency. An efficiency of about 53 % is feasible for a turbine inlet temperature of 1 200 °C. [123, Eurelectric 2001]

11.6.1.8.3 TOPHAT process

In this process, the air is humidified at the compressor inlet by the injection of water. Theoretically, an injection is also possible after each stage of the compressor. This improves the gas turbine efficiency by up to 55 %, calculated for an inlet turbine temperature of 1 200 °C, which is the highest value for the efficiency of the cycles described before. A further improvement of the TOPHAT cycle is possible by injecting water between the different compressor stages. Therefore, the water needs to be heated and pressurised. For the heating of the injection water, heat from the exhaust gases is used. [123, Eurelectric 2001]

11.6.1.8.4 CHAT cycle

The Cascade Humidified Advanced Turbine (CHAT) cycle makes use of a low-pressure and a high-pressure gas turbine on separate shafts and composed from existing compressors and turbines to allow for the increased mass flow through the turbines due to saturation with water. The cycle includes intercooling between the separate compressors, as well as reheating of the flue-gas between the separate turbines. [123, Eurelectric 2001]

11.6.1.9 Advanced lean-burn approach for gas engines

The incorporation of water injection and other techniques to lean-burn gas engines is the focus of ongoing R&D efforts with several engine manufacturers and is being pursued as part of the US Department of Energy's Advanced Reciprocating Engine Systems (ARES) programme. One of the goals of the programme is to develop a 45 % efficiency (HHV) medium-sized natural gas engine operating with NO_x emissions at a level of 15 mg/Nm³. The engine unit sizes participating in the ARES programme are in the range 1–2 MW shaft. [22, US-EPA 2008]

11.6.2 Combustion of syngas in boilers / engines / turbines

11.6.2.1 Underground (coal gasification and) power generation

Underground (coal gasification and) power generation is a technique recently proposed in the UK. See Section 11.3.2 for more details.

11.6.3 Fuel cell applications

Hydrogen fuel cells for small- to medium-scale electricity production and peak capacity could be considered as alternatives to OCGTs and reciprocating engines. Hydrogen production from renewable or from off-peak surplus power and storage could also be considered. [54, UK-TWG 2012]

12 CONCLUDING REMARKS AND RECOMMENDATIONS FOR FUTURE WORK

Timing of the review process

The key milestones of the review process for the BREF for Large Combustion Plants are summarised in Table 12.1.

Table 12.1: Key milestones in the review of the BREF for Large Combustion Plants

Key milestone	Date
Reactivation of the TWG	January 2011
Call for wishes (about 2 400 wishes were submitted by the TWG for the review)	March - May 2011
Kick-off TWG meeting	October 2011
Workshop for finalising the plant-specific questionnaire template	December 2011
Collection of information	November 2011 - September 2012
First draft of the revised LCP BREF	June 2013
End of commenting period on the first draft (8510 comments received)	September 2013
Informal intermediate TWG meeting	June 2014
Final TWG meeting	June 2015
Webinar and written consultation on remaining issues after the final TWG meeting	July - September 2015

During the review process, a total of 24 sites were visited by the EIPPCB in six Member States (Spain, the Netherlands, Germany, Poland, Estonia and Finland).

Sources of information and information gaps

During the review process, several hundred documents were shared by the TWG via the Commission's BAT information system (BATIS). These included approximately:

- 425 reports and case studies;
- 583 plant-specific questionnaires covering a total of:
 - 112 coal combustion plants, including 11 waste co-incineration plants,
 - 36 lignite combustion plants, including 9 waste co-incineration plants,
 - 65 biomass and/or peat combustion plants, including 15 waste co-incineration plants,
 - 190 natural gas combustion plants (37 boilers, 7 gas engines and 146 gas turbines),
 - 73 liquid fuel combustion plants (29 boilers, 32 engines and 12 gas turbines),
 - 61 combustion plants firing iron and steel process gases,
 - 31 combustion plants firing liquid and/or gaseous process fuels from the (petro-) chemical industry,
 - 9 combustion plants firing other fuels and/or wastes,
 - 5 gasification plants, 3 of which are not covered by the LCP BREF scope.

The plant-specific questionnaires were submitted from most of the EU countries by the individual operators, with the help of industry federations, and were checked by Member State Competent Authorities.

Contributions in the form of draft text for the BREF were provided by EPPSA, EURELECTRIC, EUTurbines, Marcogaz, EUROFER and CEFIC.

All these documents were assessed by the EIPPCB and taken into consideration for drawing up this document. Only very few of them could not be shared via BATIS due for example to copyright restrictions or confidentiality issues.

Further to the documents submission, specific tasks were carried out by the TWG:

- A subgroup was set up to make drafting proposals for the text on the gasification chapter and to design the related plant-specific questionnaire template.
- An additional plant-level data collection was carried out between June 2014 and September 2014 in order to complement the data available to assess the possible relationship between short-term and long-term emissions.
- A task force was set up to collect additional design energy efficiency data at plant level between June 2014 and September 2014.

As a result, around 340 references are included in the LCP BREF (see the References section).

Degree of consensus reached during the information exchange

A total of 85 BAT conclusions have been set for the sector. These BAT conclusions include:

- 257 BAT-AEL ranges plus 74 alternative levels expressed in footnotes to BAT-AEL tables,
- 74 BAT-AEEL ranges plus 5 alternative levels expressed in footnotes to BAT-AEL tables,
- 19 indicative emission level ranges plus 7 alternative emission levels.

At the final TWG meeting in June 2015, a high degree of consensus was reached on most of these BAT conclusions. However, 88 dissenting views were expressed by different members of the TWG.

The number of dissenting views is explained by the high number of BAT conclusions, BAT-AELs and BAT-AEELs in this document, as well as by the high number of TWG members actively involved in the BREF review process and, in particular, in the final TWG meeting (140 participants).

It should be noted that, for the majority of BAT conclusions on which dissenting views were expressed, those views included TWG members calling for a higher level of environmental protection as well as TWG members expressing the view that the agreed conclusions would be too strict.

A detailed overview of the dissenting views expressed is provided in Table 12.2.

Table 12.2: Dissenting views expressed

N°	BAT conclusion	Dissenting view	Expressed by	Alternative proposed level (if any)	
1	Scope	Exclude from the scope of the LCP BREF Activity 5.2 of the Annex I to the IED, except for the combustion of wastes that are biomass as defined in IED Article 3(31)	RO, UK	NA	
2	Scope	Exclude all co-incineration of hazardous waste from the LCP BREF scope	SE, CAN Europe, EEB	NA	
3	Definition of combustion plant	Change the definition of combustion plants as follows: '... For the purposes of these BAT conclusions, a combination formed of: <ul style="list-style-type: none"> • ... • separate combustion plants which are installed in such a way that, taking technical and economic factors into account, their flue-gases could, in the judgment of the competent authority, be discharged through a common stack. is considered as a single combustion plant. [...] For the purpose of these BAT conclusions an installation on the same site which has a technical connection and which could have an effect on emissions and pollution (e.g. abatement techniques implemented at the combustion plant) is considered as integral part of the combustion plant.'	EEB	NA	
4	Definition of combustion plant	Change the definition of combustion plant to: 'Any technical apparatus in which fuels are oxidised in order to use the heat thus generated. For the scope of these BAT conclusions, a combination formed by separate combustion units whose flue-gases are or could be discharged through a common stack shall be considered as a single combustion plant. For calculating the total rated thermal input of such a combination, the capacities of all combustion units concerned, which have a rated thermal input of at least 15 MW, shall be added'. Remove the word 'total' from the first column of all the BAT-AEL tables	FI	NA	
5	BAT 4	Reword footnote ⁽⁴⁾ : In the case of SCR or SNCR combined with wet abatement techniques (e.g. wet/semi-wet FGD or flue-gas condenser), the monitoring frequency of NH ₃ emissions may be at least once every year, if the emissions are proven to be sufficiently stable	CZ	NA	
6	BAT 7	Remove the statement that sets the higher end of the NH ₃ BAT-AEL range at 15 mg/Nm ³ in the case of combustion plants firing biomass and operating at variable loads and in the case of engines firing HFO/gas oil	NL, CAN Europe, EEB	NA	
7	BAT 15	Decrease the upper end of the BAT-AEL ranges for emissions to water for a number of parameters	TOC	CAN Europe, EEB	20 mg/l
			COD	CAN Europe, EEB	60 mg/l
			Fluoride	EEB	12 mg/l
			Sulphite	CAN Europe, EEB	5 mg/l

8	BAT 20, BAT 24, BAT 28, BAT 33, BAT 38, BAT 44, BAT 49, BAT 56, BAT 73	Set daily and yearly BAT-AELs for CO emissions to air instead of yearly indicative levels		DE	NA
		Set yearly BAT-AELs for CO emissions to air instead of yearly indicative levels		AT, BE	NA
9	BAT 20	Add in the applicability restriction of technique SNCR that it 'is not applicable to new and existing lignite-fired plants of $\geq 300 \text{ MW}_{\text{th}}$ '		EL	NA
10	BAT 20	Add in the applicability restriction of technique SCR that 'Applicability to lignite-fired plants may be constrained by the fuel characteristics'		EL	NA
11	BAT 20 Table 10.3	Change the higher end of the yearly NO_x BAT-AEL ranges for $\geq 300 \text{ MW}_{\text{th}}$ FBC boilers combusting coal and/or lignite and lignite-fired PC boilers		CZ, SK	180 mg/Nm ³ (FBC) 200 mg/Nm ³ (PC)
				EE, EURACOAL	200 mg/Nm ³
				DE, EL, PL, EURELECTRIC	190 mg/Nm ³
				CZ, SK	200 mg/Nm ³ (lignite-fired PC)
12	BAT 20 Table 10.3	Decrease the higher end of the yearly NO_x BAT-AEL range for new coal-fired PC boilers of $\geq 300 \text{ MW}_{\text{th}}$		EEB	70 mg/Nm ³
		Change the yearly NO_x BAT-AEL range for new coal-fired PC boilers of $\geq 300 \text{ MW}_{\text{th}}$		CAN Europe	< 50–70 mg/Nm ³
13	BAT 20 Table 10.3	Decrease the higher end of the yearly and daily NO_x BAT-AEL ranges for existing coal-fired PC boilers of $\geq 300 \text{ MW}_{\text{th}}$		EEB	85 mg/Nm ³ (Yearly) 140 mg/Nm ³ (Daily)
		Change the yearly NO_x BAT-AEL range for existing coal-fired PC boilers of $\geq 300 \text{ MW}_{\text{th}}$		CAN Europe	< 50–70 mg/Nm ³
14	BAT 21 Table 10.4	Change the yearly SO_2 BAT-AEL ranges for all existing and new combustion plants of $\geq 300 \text{ MW}_{\text{th}}$		CAN Europe	< 10–75 mg/Nm ³
		Change the yearly and daily SO_2 BAT-AEL ranges for existing and new combustion plants of $\geq 300 \text{ MW}_{\text{th}}$	<u>A) Coal:</u>	EEB	<u>Existing plants:</u> < 40 mg/Nm ³ (Yearly) < 75 mg/Nm ³ (Daily)

					<u>Existing plants:</u> < 130 mg/Nm ³ (Yearly) < 205 mg/Nm ³ (Daily) <u>New plants:</u> < 75 mg/Nm ³ (Yearly) < 110 mg/Nm ³ (Daily)
			<u>B) Lignite (1–3.25 % S, dry):</u>		<u>Existing plants:</u> < 40 mg/Nm ³ (Yearly) < 75 mg/Nm ³ (Daily) <u>New plants:</u> < 20 mg/Nm ³ (Yearly) < 60 mg/Nm ³ (Daily)
			<u>C) Lignite (< 1 % S, dry):</u>		
15	BAT 21 Table 10.4	Increase the higher end of the yearly SO ₂ BAT-AEL range for existing coal- and lignite-fired PC boilers		EL	170 mg/Nm ³
16	BAT 21 (Plants of ≥ 300 MW _{th} burning indigenous lignite that cannot achieve the BAT- AELs set in Table 10.4)	Change in formula (i) the multiplier factor for new FGD systems		CZ, EL, SK, Euroheat & Power	RCG x 0.02, with a maximum of 200 mg/Nm ³
		Change in formula (ii) the multiplier factor and the higher end of the range for existing FGD systems		EURACOAL	RCG x 0.04, with a maximum of 400 mg/Nm ³
17	BAT 21 Table 10.5	Add the following footnote to all HCl BAT-AEL ranges of Table 10.5: 'In the case of FBC boilers applying the dry sorption technique for SO ₂ reduction, the higher end of the range is 60 mg/Nm ³ for plants using lignite and for plants using coal with a chlorine content of 500 mg/kg or less (dry matter).'		PL, EURACOAL, EURELECTRIC	NA
18	BAT 22 Table 10.6	Change the higher end of the yearly dust BAT-AEL range for existing lignite-fired plants of ≥ 1 000 MW _{th} put into operation no later than 7 January 2014		CZ, EL, SK, EURACOAL, Euroheat & Power	10 mg/Nm ³

19	BAT 22 Table 10.6	Change the higher end of the daily dust BAT-AEL range for existing plants put into operation no later than 7 January 2014	EURACOAL	16 mg/Nm ³
20	BAT 22 Table 10.6	Decrease the higher end of the yearly dust BAT-AEL ranges for new and existing plants of 300–1 000 MW _{th}	EEB	3.5 mg/Nm ³ (New) 6 mg/Nm ³ (Existing)
		Decrease the higher end of the yearly dust BAT-AEL ranges for new and existing plants of ≥ 1 000 MW _{th}	EEB	3.5 mg/Nm ³ (Existing)
			CAN Europe, EEB	< 2 mg/Nm ³ (New)
21	BAT 23. f	Change the applicability restriction of the technique 'Carbon sorbent injection...' to 'Applicable within the constraints given by the by-product quality requirements for recovery'	CZ, EE, EL, EURACOAL, EURELECTRIC	NA
22	BAT 23.g	Change the applicability restriction of the technique 'Use of halogenated additives...' to 'Applicable within the constraints given by the by-product quality requirements for recovery, the control of halide emissions to the environment, and the long term corrosion potential'	CZ, EL, EURACOAL, EURELECTRIC	NA
23	BAT 23 Table 10.7	Set a common mercury BAT-AEL for all new and existing coal- and lignite-fired plants	CAN Europe	< 1 µg/Nm ³
24	BAT 23 Table 10.7	Add a footnote mentioning that the mercury BAT-AELs do not apply to plants operated < 1 500 h/yr	CZ, EURACOAL	NA
25	BAT 23 Table 10.7	Decrease the higher end of the mercury BAT-AEL range for new and existing coal-fired plants of < 300 MW _{th}	EEB	0.6 µg/Nm ³ (New) 3.5 µg/Nm ³ (Existing)
26	BAT 23 Table 10.7	Decrease the higher end of the mercury BAT-AEL range for new and existing coal-fired plants of ≥ 300 MW _{th}	EEB	0.5 µg/Nm ³ (New) 1.5 µg/Nm ³ (Existing)
27	BAT 23 Table 10.7	Increase the higher end of the mercury BAT-AEL range for existing lignite-fired plants of < 300 MW _{th}	CZ, EL, PL, EURACOAL, EURELECTRIC, Euroheat & Power	20 µg/Nm ³
28	BAT 23 Table 10.7	Decrease the higher end of the mercury BAT-AEL range for new and existing lignite-fired plants of < 300 MW _{th}	EEB	1 µg/Nm ³ (New) 3.5 µg/Nm ³ (Existing)
29	BAT 23 Table 10.7	Increase the higher end of the mercury BAT-AEL range for existing lignite-fired plants of ≥ 300 MW _{th}	CZ	18 µg/Nm ³
			EL, PL, EURACOAL, EURELECTRIC, Euroheat & Power	20 µg/Nm ³

30	BAT 23 Table 10.7	Decrease the higher end of the mercury BAT-AEL range for new and existing lignite-fired plants of $\geq 300 \text{ MW}_{\text{th}}$	EEB	1 $\mu\text{g}/\text{Nm}^3$ (New) 3 $\mu\text{g}/\text{Nm}^3$ (Existing)
31	BAT 23 Table 10.7	Remove footnote (¹)	EL, EURACOAL, EURELECTRIC	NA
32	BAT 24 Table 10.9	Increase the higher end of the yearly and daily NO_x BAT-AEL ranges for existing plants of $< 100 \text{ MW}_{\text{th}}$. Add a footnote indicating that for plants put into operation no later than 7 January 2014 the upper end of the daily NO_x BAT-AEL range for existing plants of $< 100 \text{ MW}_{\text{th}}$ is $310 \text{ mg}/\text{Nm}^3$	FI, CEPI, EURELECTRIC, Euroheat & Power	250 mg/Nm^3 (Yearly) 275 mg/Nm^3 (Daily)
33	BAT 24 Table 10.9	Decrease the higher end of the daily NO_x BAT-AEL range for new plants of $< 100 \text{ MW}_{\text{th}}$	BE	180 mg/Nm^3
34	BAT 24 Table 10.9	Increase the higher end of the yearly and daily NO_x BAT-AEL ranges for existing BFB boilers of $100\text{--}300 \text{ MW}_{\text{th}}$ put into operation no later than 7 January 2014	CEPI, Euroheat & Power	240 mg/Nm^3 (Yearly)
			IE	250 mg/Nm^3 (Yearly) 250 mg/Nm^3 (Daily)
		Increase the higher ends of the yearly and daily NO_x BAT-AEL ranges for BFB boilers of $100\text{--}300 \text{ MW}_{\text{th}}$ put into operation no later than 7 January 2014, in case of limitations of SNCR applicability	FI	250 mg/Nm^3 (Yearly) 275 mg/Nm^3 (Daily)
			EURELECTRIC	220 mg/Nm^3 (Yearly) 240 mg/Nm^3 (Daily)
35	BAT 24 Table 10.9	Decrease the higher end of the yearly and daily NO_x BAT-AEL ranges for new and existing plants of $100\text{--}300 \text{ MW}_{\text{th}}$	BE	<u>New:</u> 165 mg/Nm^3 (Daily)
			EEB	<u>Existing:</u> 140 mg/Nm^3 (Yearly) 190 mg/Nm^3 (Daily)

36	BAT 24 Table 10.9	Decrease the higher end of the yearly and daily NO _x BAT-AEL ranges for new and all existing plants of $\geq 300 \text{ MW}_{\text{th}}$	BE	<u>New:</u> 55 mg/Nm ³ (Yearly) 85 mg/Nm ³ (Daily) <u>Existing:</u> 150 mg/Nm ³ (Yearly) 165 mg/Nm ³ (Daily)
37	BAT 25	Change the applicability restrictions of techniques SDA and DSI to 'Generally applicable to new boilers. Not applicable to existing boilers equipped with ESP as a dust abatement technique'	FI, CEPI	NA
38	BAT 25 Table 10.10	Increase the higher end of the yearly SO ₂ BAT-AEL range for existing plants of $\geq 100 \text{ MW}_{\text{th}}$ with an average sulphur content of 0.1 % or higher	FI	160 mg/Nm ³
39	BAT 25 Table 10.10	Increase the higher end of the yearly and daily SO ₂ BAT-AEL ranges for existing plants of $< 100 \text{ MW}_{\text{th}}$ with an average sulphur content of 0.1 % or higher	FI, EURELECTRIC	300 mg/Nm ³ (Yearly) 330 mg/Nm ³ (Daily)
			CEPI, Euroheat & Power	200 mg/Nm ³ (Yearly) 330 mg/Nm ³ (Daily)
40	BAT 25 Table 10.10	Decrease the higher end of the yearly and daily SO ₂ BAT-AEL ranges for existing plants of $\geq 100 \text{ MW}_{\text{th}}$ burning fuels with an average sulphur content of 0.1 % or higher	NL	Alignment with the other BAT-AELs for biomass/peat of $< 0.1 \%$ sulphur content
41	BAT 25 Table 10.10	Decrease the higher end of the yearly and daily SO ₂ BAT-AEL ranges for new and existing plants of $< 100 \text{ MW}_{\text{th}}$	EEB	<u>New:</u> 50 mg/Nm ³ (Yearly) 85 mg/Nm ³ (Daily) <u>Existing:</u> 65 mg/Nm ³ (Yearly) 180 mg/Nm ³ (Daily)
42	BAT 25 Table 10.11	Add to footnote ⁽¹⁾ that the higher end of the yearly HCl BAT-AEL range for existing plants is 50 mg/Nm ³ in the case of existing plants operated with an ESP	FI, CEPI, EURELECTRIC, Euroheat & Power	NA
43	BAT 26 Table 10.12	Increase the higher ends of the yearly and daily dust BAT-AEL ranges for plants of $< 100 \text{ MW}_{\text{th}}$ put into operation no later than 7 January 2014	DK	25 mg/Nm ³ (Daily)
			FI, SE	24 mg/Nm ³ (Daily)

			CEPI	22 mg/Nm ³ (Yearly)
44	BAT 26 Table 10.12	Decrease the higher end of the yearly and daily dust BAT-AEL ranges for new and existing plants of < 100 MW _{th}	EEB	<u>New:</u> 3.5 mg/Nm ³ (Yearly) 6 mg/Nm ³ (Daily) <u>Existing:</u> 6 mg/Nm ³ (Yearly) 12 mg/Nm ³ (Daily)
45	BAT 26 Table 10.12	Increase the higher end of the yearly dust BAT-AEL range for existing plants of 100–300 MW _{th}	CEPI	18 mg/Nm ³
46	BAT 26 Table 10.12	Decrease the higher end of the yearly and daily dust BAT-AEL ranges for new and existing plants of 100–300 MW _{th}	EEB	<u>New:</u> 3.5 mg/Nm ³ (Yearly) 12 mg/Nm ³ (Daily) <u>Existing:</u> 5 mg/Nm ³ (Yearly) 16 mg/Nm ³ (Daily)
47	BAT 26 Table 10.12	Increase the higher end of the daily dust BAT-AEL range in the case of existing plants put into operation no later than 7 January 2014 and using only an ESP	FI	18 mg/Nm ³
48	BAT 26 Table 10.12	Decrease the higher end of the yearly and daily dust BAT-AEL ranges for new and existing plants of ≥ 300 MW _{th}	EEB	<u>New:</u> 3 mg/Nm ³ (Yearly) 8 mg/Nm ³ (Daily) <u>Existing:</u> 5 mg/Nm ³ (Yearly) 10 mg/Nm ³ (Daily)
49	BAT 27	Decrease the higher end of the mercury BAT-AEL range	CAN Europe	< 1 µg/Nm ³
50	BAT 29 Table 10.15	Increase the higher end of the daily SO ₂ BAT-AEL range for industrial HFO boilers and district heating plants of < 300 MW _{th} put into operation no later than 27 November 2003, operated < 1 500 h/yr, and for which secondary abatement techniques or fuel change from HFO to another fuel (natural gas, gas oil, LNG, etc.) is not applicable	FI, CEPI, Euroheat & Power	850 mg/Nm ³
51	BAT 29 Table 10.15	Decrease the higher end of the yearly SO ₂ BAT-AEL range for new and existing boilers of < 300 MW _{th}	EEB	75 mg/Nm ³
			CAN Europe	100 mg/Nm ³
52	BAT 30 Table 10.16	Increase the higher end of the daily dust BAT-AEL range for industrial boilers and district heating plants of < 100 MW _{th} put into operation no later than 27 November 2003, operated < 1 500 h/yr, and for which secondary abatement techniques or fuel change from HFO to another fuel (natural gas, gas oil, LNG, etc.) is not applicable	FI	30 mg/Nm ³
53	BAT 31 Table 10.17	Change the lower end of the net electrical efficiency range for a new HFO- and gas-oil-fired reciprocating engine – single cycle	EUROMOT	40 %
		Change the net electrical efficiency range for the new HFO- and gas-oil-fired reciprocating engine – combined cycle		> 46.9 %

54	BAT 32 Table 10.18	Increase the higher end of the yearly and daily NO _x BAT-AEL ranges for new plants equipped with SCR and located on remote islands	EL, EURELECTRIC, EUROMOT	240 mg/Nm ³ (Yearly) 300 mg/Nm ³ (Daily)
		Apply footnotes (1) and (2) also to new plants that cannot be fitted with secondary abatement techniques for techno-economic reasons	EL, UK, EURELECTRIC, EUROMOT	NA
55	BAT 32 Table 10.18	Decrease the higher end of the NO _x BAT-AEL range for existing plants	CAN Europe	250 mg/Nm ³
56	BAT 32 Table 10.18	Express TVOC as yearly BAT-AELs and not as indicative levels	DE, CAN Europe	NA
57	BAT 33	Increase the higher indicative level for CO	EL, EURELECTRIC	190 mg/Nm ³
			EUROMOT	192 mg/Nm ³
58	BAT 34 Table 10.19	Modify footnote (3) as follows: 'The higher end of the yearly SO ₂ BAT-AEL range is 280 mg/Nm ³ and the higher end of the daily SO ₂ BAT-AEL range is 300 mg/Nm ³ if no secondary abatement technique can be applied', and apply it both to existing and new plants	EURELECTRIC, EUROMOT, EL	NA
59	BAT 35 Table 10.20	Increase the higher ends of the yearly and daily dust BAT-AEL ranges for new plants	EL, FI, EURELECTRIC, EUROMOT	20 mg/Nm ³ (Yearly) 30 mg/Nm ³ (Daily)
		Increase the higher ends of the yearly and daily dust BAT-AEL ranges for new plants located on remote islands/SIS/MIS	EL, FI, UK, EURELECTRIC, EUROMOT	35 mg/Nm ³ (Yearly) 45 mg/Nm ³ (Daily)
60	BAT 35 Table 10.20	Decrease the higher ends of the yearly and daily dust BAT-AEL ranges for new and existing plants	EEB	<u>New:</u> 7 mg/Nm ³ (Yearly) 15 mg/Nm ³ (Daily) <u>Existing:</u> 20 mg/Nm ³ (Yearly) 40 mg/Nm ³ (Daily)
			CAN Europe	<u>Existing:</u> 10 mg/Nm ³ (Yearly)
61	BAT 35 Table 10.20	Add a footnote mentioning that yearly dust BAT-AELs for existing plants using only fuel choice apply at engine MCR load of > 85 %, in steady-state conditions	EUROMOT	NA
62	BAT 40 Table 10.23	Expand footnote (6) by adding: 'These levels may not be achievable in plants burning natural gas fuels with a methane number less than 80'	EUROMOT	NA
		Add a footnote applicable to all BAT-AEELs for gas engines mentioning that 'These levels may be negatively impacted in the case of plants equipped with a high voltage transformer'	EUROMOT	NA

63	BAT 42 Table 10.24	Increase the higher end of the yearly NO _x BAT-AEL range for new OCGTs	EUTurbines	55 mg/Nm ³
64	BAT 42 Table 10.24	Decrease the lower end of the yearly and daily NO _x BAT-AEL ranges for new OCGTs	EEB	6 mg/Nm ³ (Yearly) 7 mg/Nm ³ (Daily)
65	BAT 42 Table 10.24	Increase the higher end of the yearly NO _x BAT-AEL range for existing CCGTs of ≥ 600 MW _{th} with a net total fuel utilisation of < 75 %	EUTurbines	50 mg/Nm ³
66	BAT 42 Table 10.24	Decrease the higher end of the yearly and daily NO _x BAT-AEL ranges for existing CCGTs of ≥ 600 MW _{th} with a net total fuel utilisation of ≥ 75 %	AT	25 mg/Nm ³ (Yearly) 35 mg/Nm ³ (Daily)
			BE	55 mg/Nm ³ (Daily)
			CAN Europe, EEB	30 mg/Nm ³ (Yearly) 45 mg/Nm ³ (Daily)
67	BAT 42 Table 10.24	Decrease the higher end of the yearly and daily NO _x BAT-AEL ranges for existing CCGTs of ≥ 600 MW _{th} with a net total fuel utilisation of < 75 %	CAN Europe, EEB	25 mg/Nm ³ (Yearly) 35 mg/Nm ³ (Daily)
68	BAT 42 Table 10.24	Change the level set in footnote ⁽¹⁰⁾ regarding the higher end of the yearly NO _x BAT-AEL range for existing CCGTs of between 50 MW _{th} and 600 MW _{th} with a net total fuel utilisation of ≥ 75 % put into operation no later than 7 January 2014	EL, EURELECTRIC	75 mg/Nm ³
69	BAT 42 Table 10.24	Decrease the higher end of the yearly and daily NO _x BAT-AEL ranges for existing CCGTs of between 50 MW _{th} and 600 MW _{th} with a net total fuel utilisation of < 75 %	CAN Europe, EEB	30 mg/Nm ³ (Yearly) 40 mg/Nm ³ (Daily)
70	BAT 42 Table 10.24	Increase the lower and higher end of the NO _x BAT-AEL range for existing CCGTs of between 50 MW _{th} and 600 MW _{th} with a net total fuel utilisation of < 75 %	EURELECTRIC	15–50 mg/Nm ³
71	BAT 43 Table 10.25	Decrease the higher end of the yearly NO _x BAT-AEL range for new engines firing natural gas	CAN Europe, EEB	30 mg/Nm ³
		Decrease the higher end of the daily NO _x BAT-AEL range for new engines firing natural gas and of the yearly and daily NO _x BAT-AEL ranges for existing engines firing natural gas	CAN Europe	<u>New:</u> 60 mg/Nm ³ (Daily) <u>Existing:</u> 30 mg/Nm ³ (Yearly) 60 mg/Nm ³ (Daily)
72	BAT 44	Set CO emission levels as daily and yearly BAT-AELs for gas turbines, engines and boilers combusting natural gas and not as yearly indicative levels	CAN Europe, EEB	NA
73	BAT 47	Remove 'Selective non-catalytic reduction (SNCR)' from the techniques listed in BAT 47	EUROFER	NA
74	BAT 49	Remove 'oxidation catalyst' from the techniques listed in BAT 47	EUROFER	NA

75	BAT 47 and 48 Table 10.29 BAT 50 Table 10.30 BAT 51 Table 10.31	Change the tables title as follows: 'BAT-associated emission levels (BAT-AELs) for NO _x (respectively SO ₂ and dust) emissions to air from the combustion of a minimum of 90 % iron and steel process gases for boilers and a minimum of 55 % iron and steel process gases for CCGTs'	EURELECTRIC, EUROFER	NA
76	BAT 47 and 48 Table 10.29	Remove footnote ⁽¹⁾	EUROFER	NA
77	BAT 47 Table 10.29	Change footnote ⁽²⁾ to: 'the yearly range of 20–100 mg/Nm ³ and daily range of 22–110 mg/Nm ³ can be achieved with the implementation of SCR. The higher end of the range is associated with up to 32 % COG in the fuel mix.'	EURELECTRIC, EUROFER	NA
		Increase the higher end of the yearly NO _x BAT-AEL range for plants put into operation no later than 7 January 2014	EUROFER	140 mg/Nm ³
		Change footnote ⁽⁴⁾ to: 'In the case of plants put into operation no later than 7 January 2014, the higher end of the range is 160 mg/Nm ³ corresponding up to 32 % COG in the fuel mix. Furthermore, the higher end of the BAT-AEL range may be exceeded when SCR cannot be used and when using a high share of COG (e.g. > 32 %) and/or combusting COG with a relatively high level of H ₂ . In this case the higher end of the range is 325 mg/Nm ³ for plants put into operation no later than 27 November 2003 or 220 mg/Nm ³ for plants put into operation after this date.'	EURELECTRIC, EUROFER	NA
		Increase the lower end of the daily NO _x BAT-AEL range for existing boilers	EURELECTRIC	45 mg/Nm ³
78	BAT 48 Table 10.29	Increase the higher end of the daily NO _x BAT-AEL range for CCGTs combusting iron and steel process gases in the case of plants put into operation no later than 7 January 2014	EUROFER	80 mg/Nm ³
79	BAT 50 Table 10.30	Change footnote ⁽³⁾ to: 'The higher end of the BAT-AEL range may be exceeded when using a high share of COG (e.g. > 23 %). In this case, the higher end of the BAT-AEL range is 425 mg/Nm ³ .'	EUROFER	NA
		Add a footnote related to the higher end of the SO ₂ BAT-AEL ranges mentioning that they correspond to a COG share of up to 23 % in the case of the daily BAT-AEL, and of up to 38 % in the case of the yearly BAT-AEL	EURELECTRIC, EUROFER	NA
80	BAT 51 Table 10.31	Increase the higher end of the daily dust BAT-AEL range for boilers combusting iron and steel process gases	EURELECTRIC, EUROFER	15 mg/Nm ³
81	BAT 51 Table 10.31	Remove the yearly dust BAT-AEL range for CCGTs combusting iron and steel process gases	EUROFER	NA
82	BAT 53 Table 10.32	Remove footnote ⁽²⁾	CAN Europe, EEB	NA
83	BAT 57 Table 10.35	Change the title of Table 10.40 as follows: 'BAT-associated emission levels (BAT-AELs) for SO ₂ emissions to air from the combustion of process fuels from the chemical industry in boilers', and include a footnote associated with the 'daily average or average over the sampling period' stating that 'the higher end of the BAT-AEL range may be different on days when auxiliary liquid fuels are used. In this case, the higher end of the BAT-AEL range may correspond to the higher end of the BAT-AEL range applicable to the corresponding auxiliary fuel for the case of plants operated < 1 500 h/yr.'	CEFIC	NA

84	BAT 58 Table 10.37	Decrease the higher end of the yearly dust BAT-AEL range for existing plants	EEB	10 mg/Nm ³
85	BAT 68 Table 10.39	Decrease the higher ends of the BAT-AELs ranges for plants of > 300 MW _{th}	Cd-Tl	3 µg/Nm ³
86			Sb+As+Pb+Cr+Co+Cu+ Mn+Ni+V	0.4 mg/Nm ³
87	BAT 69 Table 10.40	Decrease the higher end of the Cd-Tl BAT-AEL range	CAN Europe, EEB	< 2 µg/Nm ³
88	BAT 71 Table 10.41	Separate TVOC and PCDD/F BAT-AELs should be established for combustion plants firing coal and/or lignite as well as biomass and/or peat	EEB	NA
NB: NA: No alternative level proposed.				

Consultation of the Forum and subsequent formal adoption procedure of the BAT Conclusions

In accordance with Article 13(3) of the Directive, the forum gave its opinion on the draft Best Available Techniques (BAT) reference document for the Production of Pulp, Paper and Board as presented at the meeting of the forum of 20 October 2016:

1. The forum welcomed the draft Best Available Techniques (BAT) reference document for Large Combustion Plants as presented by the Commission.
2. The forum acknowledged the discussions held at its meeting of 20 October 2016 and agreed that the changes to the draft Best Available Techniques (BAT) reference document for Large Combustion Plants, as proposed in Annex A, should be included in the final document.
3. The forum reaffirmed the comments in Annex B as representing the views of certain members of the forum but, on which, no consensus existed within the forum to include them in the final document.

Subsequently, the Commission took the opinion of the IED Article 13 Forum into account when preparing the draft Commission Implementing Decision establishing best available techniques (BAT) conclusions for Large Combustion Plants. The IED Article 75 Committee, at its meeting of 28 April 2017, gave a positive opinion on this draft Commission Implementing Decision.

Subsequently, the Commission Implementing Decision (EU) 2017/1442 establishing best available techniques (BAT) conclusions for Large Combustion Plants was adopted on 31 July 2017 and published in the Official Journal of the European Union (OJ L 212, 17.08.2017, p. 1).

Recommendations for future work

The information exchange revealed a number of issues that should be addressed during the next review of the LCP BREF. This includes the following recommendations:

- To collect more information on start-up, shutdown and OTNOC emissions.
- To collect more information on the operation of engines and turbines for emergency use, and on the number of hours they are operated.
- Related to emissions to water, to collect:
 - information on techniques to reduce chloride emissions to water from flue-gas treatment;
 - information on techniques to reduce total nitrogen emissions to water from flue-gas treatment;
 - more information on biological treatment techniques.
- Related to emissions to air, to collect:
 - Ammonia emissions data from the use of selective catalytic reduction (SCR) and/or selective non-catalytic reduction (SNCR) for the abatement of NO_x emissions, in particular for engines.
 - More information on the use of SCR when combusting natural gas in boilers.
 - More information on the use of SCR when combusting natural gas in turbines.
 - More information on the applicability of oxidation catalysts when combusting natural gas.
 - More information on the applicability of PEMS to other sectors besides OCGTs. Follow the ongoing development of an EN standard related to PEMS.
 - More information on CCGT plants with steam/water injection being converted to OCGTs, and especially in relation to the availability of a source of water of a suitable quality.

- More information on offshore platforms, in particular on the use of dual fuel gas turbines combusting liquid fuels.
- Further information on the applicability of the SCR technique to prevent and/or reduce NO_x emissions to air while limiting CO and N₂O emissions to air from the combustion of coal and/or lignite, in particular with respect to the combustion of indigenous fuels.
- More data on N₂O emissions from coal- and/or lignite-fired CFB boilers.
- More information in order to assess if there is a need to differentiate between coal and lignite concerning SO₂ emission levels.
- Information on the combustion of biomass with a high alkaline content.
- More information on the performance and efficiency of boiler sorbent injection for BFB boilers to prevent and/or reduce SO_x, HCl and HF emissions to air from the combustion of solid biomass and/or peat.
- More information on the combustion of straw and peat.
- More information on the combustion of straw concerning HF emissions.
- Short-term data on HCl emissions, and information on the relationship between the use of S-rich fuels or elemental S (extended to other additives) and the HCl/HF emission levels.
- More information, in the context of waste co-incineration, on Mn emissions originating from biomass and/or peat.
- More information, in the context of waste co-incineration, on PCDD/F emissions in order to review if there is a need to differentiate between biomass/peat and coal/lignite combustion.
- More information on the use of the SCR technique to prevent and/or reduce NO_x emissions to air from the combustion of HFO and/or gas oil in reciprocating engines in small isolated systems.
- Further information on the impact of high nitrogen and hydrogen contents on NO_x emissions from the combustion plants using process fuels from the chemical industry.

Suggested topics for future R&D work

The Commission is launching and supporting, through its Research and Technological Development programmes, a series of projects dealing with clean technologies, emerging effluent treatment and recycling technologies and management strategies. Potentially, these projects could provide a useful contribution to future BREF reviews. Readers are therefore invited to inform the European IPPC Bureau of any research results which are relevant to the scope of this document (see also the fifth section of the Preface of this document).

13 ANNEXES

13.1 Annex I - List of European plants that took part in the data collection exercise in 2012

Table 13.1: List of European plants that took part in the data collection exercise in 2012

Plant code	Country	Plant name	Combustion process	Techniques (Air emissions and/or Energy efficiency)	Industrial sector	Total rated thermal input (MW)	Type of fuel (%)	Total operating time under NOC (hours)	Equivalent full load operating factor (%)	Year of the first commissioning
001V	AT	Voestalpine Stahl GmbH - Block 01 - Linz	CCGT	DLN - SCR + Air preheating	Iron & Steel	165	BF 34 - NG 33 - COG 27 - BOF 5	8072	65	1996
002V	AT	Voestalpine Stahl GmbH - Block 03 - Linz	GasB	LNB - SCR - Air preheating	Iron & Steel	109	BF 67 - COG 16 - BOF 11 - NG 6	7817	84	2002
003V	AT	Voestalpine Stahl GmbH - Block 04 - Linz	GasB	LNB - SCR - Air preheating	Iron & Steel	90	BF 65 - COG 19 - BOF 11 - NG 5	7132	80	1985
004V	AT	Voestalpine Stahl GmbH - Block 05 - Linz	GasB	LNB - SCR - Air preheating	Iron & Steel	90	BF 65 - COG 20 - BOF 11 - NG 4	8221	79	1985
005V	AT	Voestalpine Stahl GmbH - Block 06 - Linz	GasB	FGR - SCR - Air preheating	Iron & Steel	223	BF 39 - NG 28 - COG 27 - BOF 6	5561	71	1973
006V	AT	Voestalpine Stahl GmbH - Block 07 - Linz	GasB	FGR - Fuel staging - LNB - SCR - Air preheating	Iron & Steel	385	BF 62 - COG 17 - BOF 11 - NG 10	7162	87	2010
007V	AT	Voestalpine Stahl Donawitz GmbH & Co KG - Block 01 - Donawitz	GasB	SCR - Air and fuel preheating	Iron & Steel	180	BF 79 - BOF 14 - NG 7	8500	80	2008
008V	AT	Voestalpine Stahl Donawitz GmbH & Co KG - Block 02 - Donawitz	CCGT	DLN - SCR	Iron & Steel	85	NG 88 - BOF 12	1417	81	2001
009V	AT	Voestalpine Stahl Donawitz GmbH & Co KG - Block 03 - Donawitz	GasB	Air preheating	Iron & Steel	80	BF 81 - BOF 12 - NG 7	994	84	1986
10V	BE	Electrabel GDF Suez - Amercoeur 1 - Roux	CCGT	DLN	Power	749	NG 100	6188	87	2009
11-1V	BE	Electrabel GDF Suez - Herdersbrug GT11 - Brugge	CCGT	DLN	Power	460	NG 100	6808	83	1998
11-2V	BE	Electrabel GDF Suez - Herdersbrug GT12 - Brugge	CCGT	DLN	Power	460	NG 100	7637	83	1998

12V	BE	EDF Luminus - Gent Ringvaart - Gent	CCGT	DLN	Power	644	NG 100	7184	92	1997
13V	BE	Electrabel GDF Suez - Les Awirs 4 - Flémalle	WBB	LNB - Fuel and Air staging - ESP	Power	285	WB 100	7849	76	1968
14V	BE	Electrabel GDF Suez - Rodenhuize 4 - Desteldonk	WBB	FGR - LNB - AS - SCR - ESP	Power	745	WB Pellets 99	6500	75	1979
15V	BE	Electrabel GDF Suez - Knippegroen-Zelzate 2 - Gent	GasB	Fuel/Air staging - LNB Separate burners (BF/NG)	Iron & Steel	750	BF 92 - NG 8	8290	73	2010
16-1V	BE	EDF Luminus - OCGT31 - Gent	OCGT	DLN	Power	150	NG 100	778	71	2008
16-2V	BE	EDF Luminus - OCGT32 - Gent	OCGT	DLN	Power	150	NG 100	521	71	2008
17V	BE	E.ON - Langerlo 1 - Genk	WBB	LNB - Air staging - FGR - SCR - WFGD - ESP	Power	1200	Coal 92 - WBB 5 - NG 3	5863	76	1975
18-1V	CZ	United Energy - Teplarna Komorany - Most	BFB	Air staging - BF	Power and district heating	748	Lignite 98 - WBB 2	3608	12	1951
18-2V	CZ	United Energy - Teplarna Komorany - Most	BFB	Air staging - BF	Power and district heating	760	Lignite 98 - WBB 2	8760	NA	1951
19VC	CZ	Teplarna Tabor - Boiler K7	CFB	Boiler sorbent injection - ESP	Power and district heating	74	Lignite 100	5794	86	2010
20-1V	CZ	Dalkia - Teplarna Frydek- Mistek - Boiler K1	PCFB	Cyclone - BF	Power and district heating	42	Coal 93 - WBB 7	6636	77	1974
20-2V	CZ	Dalkia - Teplarna Frydek- Mistek - Boiler K2	PCFB	Mechanical separator	District heating	72	Coal 99 - Wood 1	2041	64	1974
21_1V	CZ	Prazska teplarenska - Vytopena Krc K1 - Prague	GasB	LNB alone - District heating	District heating	22	NG 100	68	73	1993
21_2V	CZ	Prazska teplarenska - Vytopena Krc K4 - Prague	GasB	Recently built - LNB alone - District heating	District heating	21	NG 100	313	92	2008
21_3V	CZ	Prazska teplarenska - Vytopena Krc K5 - Prague	GasB	LNB alone - District heating	District heating	29	NG 100	630	70	2007
22_1V	CZ	Plzenska teplarenska - Plzen	PCFB	LNB - Air staging	Power and district heating	157	Lignite 60 - Wood 40	8014	78	2000

22_2V	CZ	Plzenska teplarenska - Plzen	CFB	LNB - AS	Power and district heating	39	Forest R 100	8001	109	2010
23V	CZ	CEZ - Tusimice	DBB	Air/Fuel staging - LNB - FGR - WFGD - ESP - Stack = cooling tower	Power	890	Lignite 100	7872	69	2009
24V	CZ	CEZ - Power plant Detmarovice - Ostrava	DBB	LNB - Air staging - WFGD - ESP	Power	2180	Coal 100	8628	NA	1975
25-1V	CZ	CEZ - FK1 - Hodonin	CFB	Air staging - FGR - Boiler sorbent injection - ESP	Power	144	Lignite 96	8167	81	NA
25-2V	CZ	CEZ - FK2 - Hodonin	CFB	AS - FGR - Sorbent injection - ESP	Power	144	WB 99.8	7075	70	NA
26VC	DK	Dong Energy - Avedøreværket, Plant 1 - Avedøre	WBB	LNB - SCR - WFGD - ESP - Supercritical steam	Power and district heating	595	Coal 94 - HFO 6	6131	89	1990
27VC	DK	Dong Energy - Avedøreværket, Plant 2 - Avedøre	WBB	LNB - SCR - WFGD - ESP - Supercritical steam	Power and district heating	805	WB Pellets 66 - NG 33 - HFO 1	6830	86	1982
28V	DK	Dong Energy - H.C. Ørsted Værket - København	Liquid B	LNB - Fuel choice	District heating	110	Gas oil 100	1030	16	2006
29V	DK	Dong Energy - Herningværket - Herning	DBB	LNB - ESP	Power and district heating	289	WB Chips 59 - WB Pellets 24 - NG 17	5605	77	2008
30V	DK	Silkeborg Forsyning - Silkeborg Kraftvarmeværk - Silkeborg	CCGT	DLN + Control system	Power and district heating	230	NG 100	4702	97	1995
31V	DK	Vattenfall - Amagerværket, Plant 1 - Amager	WBB	LNB - AS - SCR - ESP - WFGD - Supercritical - CHP	Power and district heating	355	WB Pellets 75 - Herbaceous 25	6544	74	1981
33V	DK	Vattenfall - Fynsværket - plant 8 - Odense	GB	Air staging - BF - Combined WFGD and FG condenser	Power and district heating	118	Straw 100	7103	105	2010
34V	DK	Vattenfall - Nordjyllandsværket unit 3 - Aalborg	WBB	LNB - Air staging - FGR - SCR - WFGD - ESP - Supercritical steam - Double reheat	Power and district heating	819	Coal 100	8242	99	1998
39	EE	CHP AS Sillamäe SEJ - Sillamäe	WBB	Standard burners - Multicyclones - ESP	NA	88	Oil shale 91	8760	40	1953
40	EE	Sillamäe Caterpillar CHP - Sillamäe	SG Engine	Lean-burn alone	NA	15	NG 100	8400	89	2004

42V	FI	Kaukaan Voima Oy - Kaukaa power plant - Lappeenranta	CFB	LNB - AS - FGR - SNCR - Sorbent injection - ESP	Pulp and paper	410	Bark 60 - Peat 20 - Forest R 20	7186	59	2009
46V	FI	Porin Prosessivoima - Pori	CFB	SNCR - DSI - BF - ACI	Chemical industry	206	Peat 47 - WB - 25 Forest R 16 - Solid waste 8 - Coal 3	8261	86	1999
49V	FI	Helsingin Energia - Vuosaari B - Helsinki	CCGT	DLN alone - GT blades modification	Power and district heating	991	NG 100	8371	40	1998
54V	FI	Helsingin Energia - Lassila district heating plant, unit 1 - Helsinki	Liquid B	CHP	District heating	132	HFO 95 - Gas oil 5	83	78	1977
55V	FI	Helsingin Energia - Lassila district heating plant, unit 4 - Helsinki	GasB	HFO/gas oil mixing - District heating	District heating	50	NG 96 - HFO 3 - Gas oil 1	1163	79	1995
56V	FI	Helsingin Energia - Munkkisaari district heating plant, unit 1 - Helsinki	Liquid B	Multicyclones - Air staging - LNB	District heating	50	HFO 100	266	71	2005
61V	FR	Rhodia - unit 4 - Chalampé	Liquid B	SCR - Fuel choice	Chemical industry	110	Liquid process fuel 100	8171	52	1966
62-1V	FR	Rhodia - unit 5 - Chalampé	Boiler	SCR	Chemical industry	180	NG 43	8168	43	1972
62-2V	FR	Rhodia - unit 5 - Chalampé	Boiler	SCR	NA	180	Liquid process fuel 57	8168	43	1972
63V	FR	Rhodia - unit 6 - Chalampé	GasB	FGR alone	Chemical industry	185	NG 100	7813	50	2001
65-1V	FR	Kronembourg - K2 - Obernai	GasB	Multi-fuel LNB	Food & Drink	15	NG 67 - Biogas 16 - HFO 17	3136	44	1974
65-2V	FR	Kronembourg - K2 - Obernai	GasB	Multi-fuel LNB	Food & Drink	15	NG 66.4 - HFO 17.2 - Biogas 16.4	3136	44	1974
66V	FR	Smurfit/Kappa/Dalkia - Facture	BFB	Air staging - FGR - BF - Double reheat - CHP	Pulp and paper	124	WB 10 - Bark 40 - WB 50	8337.25	109	2010
67V	FR	Sobeji/Total - Lacq	GasB	LNB (FGR) - FGR	Oil refining	88	NG 100	8000	70	1959
68V	FR	Cofely - Stains	Liquid B	LNB - Multicyclones	District heating	65	HFO 100	1800	15	1975

69V	FR	CPCU/Cofely - Saint Ouen	BFB	Air staging - FGR - SNCR/ecotube, mechanical deduster, DSI - ESP with SO ₃ injection	District heating	450	Coal coke 100	3500		1989
70V	FR	CPCU/Cofely - Grenelle	Liquid B	Steam injection - LNB - Fuel staging - FGR - SCR - Fuel choice - DSI - BF	District heating	178	HFO 100	736	116	
71V	FR	EDF - Unit 2 - Vaires sur Marne	OCGT	Water injection	Power	545	Gas oil 100	313	82	2008
72V	FR	Norske Skog - Golbey	BFB	Air staging - FGR - SNCR - BF	Pulp and paper	85	Solid waste 100	8100	100	1998
73V	FR	TOTAL Petrochemicals - CS1 boiler - Carling	Boiler	LNB - Air staging	Chemical industry	133	Process gases 100	8707	39	1976
74V	FR	UEM - Chambière	CCGT	DLN alone + DCS	NA	142	NG 100	4659	98	1992
75-1V	FR	Naphtachimie - Centrale sud - Boiler4 - Lavera	Boiler	LNB - Air staging	Chemical industry	184	Gaseous process fuel - 27.9 - Liquid process fuel 24.7 - HFO 47.4	5979	63	1972
75-2V	FR	Naphtachimie - Centrale sud - Boiler5 - Lavera	Boiler	SNCR	Chemical industry	184	Gaseous process fuel 15.7 - Liquid process fuel 28.9 - HFO 55.1	8700	68	1972
77V	FR	EDF - Cordemais 4	DBB	SCR - WFGD - ESP	Power	1500	Coal 98	5492	80	1983
78V	FR	EDF - Cordemais 4	Liquid B	Steam injection - LNB - Air staging	Power	2000	HFO 100	1102	53	1976
81V	FR	CCIAG - La Poterne - Grenoble	CFB	Air staging - FGR - SNCR - Boiler sorbent injection - Cyclone - ESP - Double reheat	NA	81	Coal 66 - WBB 25 - Waste 9	4293	85	1993
83V	FR	CCIAG - Vaucanson - Grenoble	Liquid B	LNB - Fuel staging - Fuel choice - Multicyclones	NA	41	HFO 100	219	49	1967
85V	FR	ALFI - Air Liquide - COGENAL - Plateforme de Belle Etoile - Saint Fons	CCGT	DLN	Chemical industry	175	NG 100	3677	70	1998
86V	FR	ALFI - Air Liquide - COGENAL - Plateforme de Belle Etoile - Saint Fons	GasB	LNB	NA	168	NG 95 - Process gases from petrochemical 5	8760	16	1964

91V	FR	GIE-Osiris - Boiler1 - Roussillon	GasB	LNB - Air preheating	Chemical industry	60	NG 100	5665	39	1971
92V	FR	GIE-Osiris - Boiler3 - Roussillon	GB	Air staging - ESP	Chemical industry	90	Coal 100	7629	78	1992
93V	FR	GIE-Osiris - Boiler6 - Roussillon	GB	Air staging - ESP	Chemical industry	52	Coal 100	6119	56	1957
99V	FR	EON - Centrale Emile HUCHET - Unit4 - Saint Avold	CFB	BF	Power	330	Coal 100	3779	108	1990
100V	FR	EON - Centrale Emile HUCHET - Unit7 - Saint Avold	CCGT	DLN	Power	750	NG 100	5309	80	2010
101V	FR	EON - Centrale Emile HUCHET - Unit5 - Saint Avold	DBB	Air staging - SCR - WFGD - ESP	Power	1510	Coal 100	2905	94	1984
102V	FR	CRTgaz - Voisines	OCGT	DLE/DLN - Bleed valve on combustion air for lowering the air excess	Mechanical drive	24	NG 100	3435	80	2005
104V	DE	Energie SaarLorLux AG - GDF - HKW Römerbrücke - Saarbrücken	CCGT	DLN	NA	165	NG 100	6591	64	2005
105V	DE	Stadtwerke Bielefeld GmbH - GuD-HKW Hillegossen - Bielefeld	CCGT	DLN	Pulp and paper	100	NG 100	8284	87	2005
107V	DE	Stadtwerke Leipzig GmbH - Wittenberge-Piesteritz - Wittenberge	CFB	AS - FGR - BF	NA	67	Forest R 100	6603	93	2009
108-1V	DE	RWE Innogy Cogen GmbH - Holzheizkraftwerk Berlin - Neukölln - Berlin	GB	FGR - AS - SNCR - DSI Activated carbon - BF	NA	53	WB 100 (including waste wood)	7228	94	2004
108-2V	DE	RWE Innogy Cogen GmbH - Holzheizkraftwerk Berlin - Neukölln - Berlin	GB	FGR - AS - SNCR - DSI Activated carbon - BF	NA	53	WB 100 (including waste wood)	6750	93	2004
109VC	DE	Pfeifer & Langen KG - Werk Jülich Kessel 5 - Jülich	DBB	SNCR - 2 Cyclones - DSI - BF	Food & Drink	115	Lignite 100	4872	82	2004
111-1V	DE	WSW Energie & Wasser AG - HKW Barmen, Block 1 - Wuppertal	CCGT	DLN	Power and district heating	88	NG 100	6084	94	2005

111-2V	DE	WSW Energie & Wasser AG - HKW Barmen, Block 1 - Wuppertal	CCGT	DLN	Power and district heating	88	NG 100	6052	94	2005
112-1V	DE	WSW Energie & Wasser AG - HKW Barmen, Block 2 - Wuppertal	OCGT	NA	Power	119	Gas oil 100	5	97	1980
112-2V	DE	WSW Energie & Wasser AG - HKW Barmen, Block 2 - Wuppertal	OCGT	NA	Power	119	Gas oil 100	10	97	1980
114-1V	DE	Stadtwerke Düsseldorf AG - HKW Düsseldorf Lausward Block A, Fernwärmekessel 1 Düsseldorf	GasB	LNB - District heating	District heating	64	NG 100	1489	55	2000
114-2V	DE	Stadtwerke Düsseldorf AG - HKW Düsseldorf Lausward Block A, Fernwärmekessel 2 - Düsseldorf	GasB	LNB - District heating	District heating	64	NG 100	1317	49	2000
114-3V	DE	Stadtwerke Düsseldorf AG - HKW Düsseldorf Lausward Block B, Fernwärmekessel 1 Düsseldorf	GasB	LNB - District heating	District heating	64	NG 100	1561	51	2004
115V	DE	E.ON Kraftwerke GmbH - Heizwerk FWK Westerholt - Gelsenkirchen	Liquid B	LNB	District heating	140	Gas oil 100	NA	NA	2004
116VC	DE	RWE Power AG - Kraftwerk Niederaußem - Bergheim	DBB	LNB - Air staging - WFGD - ESP - Supercritical steam	Power	2306	Lignite 100	6973	80	2003
117-1VC	DE	Vattenfall Europe Generation AG - Kraftwerk Lippendorf, Block R - Böhlen	DBB	LNB - Air staging - WFGD - ESP - Supercritical steam	Power and district heating	2465	Lignite 97 - Waste 3	8306	81	2001
117-2VC	DE	Vattenfall Europe Generation AG - Kraftwerk Lippendorf, Block S - Böhlen	DBB	LNB - Air staging - WFGD - ESP - Supercritical steam	Power and district heating	2465	Lignite 97 - Waste 3	7921	81	2001
119-1V	DE	E.ON Kraftwerke GmbH - Kraftwerk Irsching, Block 5 - GT51 - Vohburg	CCGT	DLN	Power	1424	NG 100	6430	75	NA

119-2V	DE	E.ON Kraftwerke GmbH - Kraftwerk Irsching, Block 5 - GT52 - Vohburg	CCGT	DLN	Power	1424	NG 100	6430	75	NA
121V	DE	RWE Power AG - Kraftwerk Ibbenbüren, Block B - Ibbenbüren	WBB	LNB - Air staging - SCR - WFGD - ESP	Power	2100	Coal 96 - Waste 1	7958	84	1985
122aVC	DE	Steag GmbH - Kraftwerk Voerde, Block A - Voerde	DBB	LNB - SCR - WFGD - ESP	Power	1870	Coal 100	6342	78	1982
122bVC	DE	Steag GmbH - Kraftwerk Voerde, Block B - Voerde	DBB	LNB - SCR - WFGD - ESP	Power	1870	Coal 100	6395	78	1985
123V	DE	E.ON Kraftwerke GmbH - Kraftwerk Staudinger Block 5 - Großkrotzenburg	DBB	LNB - Air staging - SCR - WFGD - ESP	Power and district heating	1370	Coal 99.9 - Waste 0.1	7034	73	1992
124bVC	DE	E.ON Kraftwerke GmbH - Kraftwerk Scholven, Block B - Gelsenkirchen	DBB	LNB - Air staging - SCR - WFGD - ESP	Power and district heating	990	Coal 99	6463	80	1968
124fVC	DE	E.ON Kraftwerke GmbH - Kraftwerk Scholven, Block F - Gelsenkirchen	DBB	LNB - Air staging - SCR - WFGD - ESP	Power	1860	Coal 99	4346	78	1985
125V	DE	N.prior Energy GmbH - PN Biomasseheizkraftwerk Papenburg GmbH & Co. KG - Papenburg	CFB	LNB - AS - FGR - DSI Activated carbon - cyclones - BF	Power	65	WB 99.8	7857	99	2003
127-1VC	DE	Vattenfall Europe Generation AG - Kraftwerk Schwarze Pumpe Block A - Spremberg	DBB	LNB - Air staging - WFGD - ESP - Supercritical steam	Power and district heating	2100	Lignite 98 - Waste 2	8145	91	1998
127-2VC	DE	Vattenfall Europe Generation AG - Kraftwerk Schwarze Pumpe Block B - Spremberg	DBB	LNB - Air staging - WFGD - ESP - Supercritical steam	Power and district heating	2100	Lignite 98.5 - Waste 1.5	6312	91	1998
128-1VC	DE	Vattenfall Europe Generation AG - Kraftwerk Jänschwalde A - Peitz	DBB	LNB - Air staging - WFGD - ESP	Power and district heating	1524	Lignite 97 - Waste 3	6561	83	1981
128-2VC	DE	Vattenfall Europe Generation AG - Kraftwerk Jänschwalde B - Peitz	DBB	LNB - Air staging - WFGD - ESP	Power and district heating	1524	Lignite 97 - Waste 3	7736	83	1982
128-3VC	DE	Vattenfall Europe Generation AG - Kraftwerk Jänschwalde C - Peitz	DBB	LNB - Air staging - WFGD - ESP	Power and district heating	1524	Lignite 98 - Waste 2	8587	84	1983

128-4VC	DE	Vattenfall Europe Generation AG - Kraftwerk Jänschwalde D - Peitz	DBB	LNB - Air staging - WFGD - ESP	Power and district heating	1524	Lignite 98 - Waste 2	8404	85	1985
129-1VC	DE	Vattenfall Europe Generation AG - Kraftwerk Jänschwalde E - Peitz	DBB	LNB - Air staging - WFGD - ESP	Power and district heating	1524	Lignite 100	7700	85	1987
129-2VC	DE	Vattenfall Europe Generation AG - Kraftwerk Jänschwalde F - Peitz	DBB	LNB - Air staging - WFGD - ESP	Power and district heating	1524	Lignite 100	7346	85	1988
130VC	DE	RWE Power AG - Kraftwerk Neurath, Block E - Grevenbroich	DBB	LNB - Air staging - WFGD - ESP	Power	1702	Lignite 100	7345	84	1975
131V	DE	E.ON Kraftwerke GmbH - Kraftwerk Wilhelmshaven	DBB	LNB - Air staging - SCR - WFGD - ESP	Power	1870	Coal 98.8 - Gas oil 1 - Coke 0.2	5721	83	1976
132VC	DE	E.ON Kraftwerke GmbH - Kraftwerk Heyden - Petershagen	DBB	LNB - Air staging - SCR - Fuel staging - WFGD - ESP	Power	2150	Coal 100	6836	78	1987
133VC	DE	E.ON Kraftwerke GmbH - Kraftwerk Schkopau - Korbetha	DBB	LNB - Air/Fuel staging - WFGD - ESP - Supercritical steam	Power and Chemical industry	1256	Lignite 100	6634	NA	NA
134VC	DE	E.ON Kraftwerke GmbH - FWK Buer - Gelsenkirchen	DBB	LNB - Air staging - SCR - WFGD - ESP - Supercritical steam	Power and district heating	383	Coal 99.5 - HFO 0.5	6909	91	1985
135V	DE	E.ON Kraftwerke GmbH - Kraftwerk Kirchmöser - Brandenburg	CCGT	DLN	Power	360	NG 100	4081	95	1994
136V	DE	E.ON Kraftwerke GmbH - Kraftwerk Irsching, Block 4 - Vohburg an der Donau	CCGT	Retrofit from GT to CCGT - DLN	Power	900	NG 100	3914	86	2007
137VC	DE	RWE Power AG - Kraftwerk Neurath, Block A - Grevenbroich	DBB	Air staging - LNB - FGR - WFGD - ESP	Power	855	Lignite 100	6720	77	1972
138V	DE	Steag GmbH - Heizkraftwerk Herne, Block 3 - Herne	WBB	LNB - Air staging - SCR - WFGD - ESP with SO ₃ injection	Iron & Steel	805	Coal 91 - COG 9	5225	65	1963
139V	DE	Steag GmbH - Heizkraftwerk Herne, Block 4 - Herne	DBB	LNB - Air staging - SCR - WFGD - ESP with SO ₃ injection - Supercritical steam	Iron & Steel	1278	Coal 93 - COG 7	6189	62	1989

141V	DE	Grosskraftwerk Mannheim AG - Großkraftwerk Mannheim, Block 6 - Mannheim	DBB	LNB - Air staging - SCR - WFGD - ESP	Power and district heating	670	Coal 100	6425	86	1975
142V	DE	RWE Power AG - Gersteinwerk - Werne	DBB	LNB - Air staging - SCR - WFGD - ESP	Power	1900	Coal 95 - Waste 4	6749	76	1984
144-1V	DE	RWE Power AG - Kraftwerk Duisburg-Huckingen BlockA - Duisburg	GasB	FGR - LNB Separate burners (BF/COG/NG)	Iron & Steel	840	BF 67 - COG 22 - NG 10	6933	48	1975
144-2V	DE	RWE Power AG - Kraftwerk Duisburg-Huckingen BlockB - Duisburg	GasB	FGR - LNB Separate burners (BF/COG/NG) - Retrofits automation and S turbine	Iron & Steel	840	BF 69 - COG 20 - NG 11	7280	54	1976
145V	DE	RWE Power AG - Kraftwerk Duisburg-Hamborn, Block 5 - Duisburg	GasB	LNB - Air staging - FGR - SCR - Air and fuel preheating	Iron & Steel	550	BF 85 - COG 14	7871	92	2003
146V	DE	Infracor GmbH - Kraftwerk I - Marl	WBB	SCR - WFGD - BF	Chemical industry	710	Coal 90 - Liquid Waste 6 - HFO 1 - NG 1	8696	83	1971
147-1	DE	Industriepark Wolfgang GmbH - Kesselhaus - Hanau	GasB	NA	Chemical industry	22	NG 100	8736	34	1990
147-2	DE	Industriepark Wolfgang GmbH - Kesselhaus - Hanau	GasB	NA	Chemical industry	52	NG 61.1 - Gas oil 38.9	8736	NA	1970
147-3	DE	Industriepark Wolfgang GmbH - Kesselhaus - Hanau	GasB	NA	Chemical industry	22	NG 97 - Gas oil 3	8736	27	1990
149-1	DE	Evonik Degussa GmbH - Kesselhaus 5 - Krefeld	CCGT	DLN (GT)	Chemical industry	37	NG 100	7832	87	1995
149-2	DE	Evonik Degussa GmbH - Kesselhaus 4 - Krefeld	GasB	FGR	Chemical industry	27	NG 100	8550	39	1986
150	DE	Evonik Degussa GmbH - Kesselhaus - Wesseling	GasB	Standard burners (retrofitted from coal to gas in 1999)	Chemical industry	176	NG 100	8760	12	1976
152	DE	Evonik Röhm GmbH - Heizkraftwerk - Worms	GasB	LNB air/fuel staging	Chemical industry	127	Process gaseous fuels (83+12) - NG 4	8300	37	1963

153-1	DE	Solvay Chemicals GmbH - Cogeneration plant TG 1 - Rheinberg	CCGT	Water injection	Chemical industry	74	NG 100	7030	89	1996
153-2C	DE	Solvay Chemicals GmbH - Coal Boiler GN 6 - Rheinberg	WBB	LNB - Air staging - SNCR - DSI	Chemical industry	192	Coal 100	8415	81	1983
153-3	DE	Solvay Chemicals GmbH - Cogeneration plant TG 2 - Rheinberg	CCGT	Water injection	Chemical industry	74	NG 100	6478	96	1996
154-1	DE	BASF AG - Ludwigshafen - Mitte - Schnellstartreservessel 10 - Ludwigshafen	Liquid B	No abatement techniques	Chemical industry	327	Gas oil 100	1015	21	1970
154-2	DE	BASF AG - Ludwigshafen - Mitte - Schnellstartreservessel 11 - Ludwigshafen	Liquid B	No abatement techniques	Chemical industry	327	Gas oil 100	1015	21	1970
154-3	DE	BASF AG - Ludwigshafen - Mitte - Kraftwerk Nord Kessel 301 + Kessel 302 - Ludwigshafen	Boiler	LNB - FGR	Chemical industry	368	Process gas fuel 43 - NG 30 - Liquid process fuel 27	7716	63	1964
154-4	DE	BASF AG - Ludwigshafen - Mitte - GuD A800 Block 11 - Ludwigshafen	CCGT	DLN	Chemical industry	715	NG 100	8334	72	2005
154-5	DE	BASF AG - Ludwigshafen - Mitte - GuD A800 Block 12 - Ludwigshafen	CCGT	DLN	Chemical industry	715	NG 100	8334	72	2005
154-6	DE	BASF AG - Ludwigshafen - Mitte - GuD C211 Block 1 - Ludwigshafen	CCGT	DLN - Planned burner retrofit in 2012	Chemical industry	500	NG 100	6940	84	1997
154-7	DE	BASF AG - Ludwigshafen - Mitte - GuD C211 Block 2 - Ludwigshafen	CCGT	DLN	Chemical industry	500	NG 100	6940	84	1997
156V	DE	CURRENTA GmbH&CO OHG - WSK L57 - Krefeld	CFB	Fuel staging - Air staging - FGR - Boiler sorbent injection - Cyclone - BF	Chemical industry	207	Coal 61 - NG 25 - Gaseous fuel 11 - Liquid waste 2	7884	73	1992
157-1V	DE	Dow Deutschland Anlagen GmbH - Steam boiler 15HA - Stade	GasB	LNB - FGR	Chemical industry	165	NG 25 - H2 75	7452	36	2010

157-2V	DE	Dow Deutschland Anlagen GmbH - Steam boiler 16HA - Stade	GasB	LNB - FGR	Chemical industry	165	NG 25 - H2 75	6792	38	2010
158V	DE	Open Grid Europe GmbH - Werne M8 - Werne, NRW	OCGT	DLN	Mechanical drive	67	NG 100	5996	74	2000
159V	DE	Open Grid Europe GmbH - Emsbüren M2 - Emsbüren, NS	OCGT	DLN to be installed in 2014	Mechanical drive	28	NG 100	3168	64	1992
160V	DE	MEGAL GmbH - Waidhaus MEGAL M2 - Waidhaus, BY	OCGT	To be decommissioned for reinvestment in 2014	Mechanical drive	53	NG 100	2658	69	1982
161V	DE	E.ON Gas Storage GmbH - Breitbrunn M1 - Breitbrunn, BY	OCGT	DLN	Mechanical drive	32	NG 100	2781	85	1998
162V	DE	METG - Porz M5 - Köln, NRW	OCGT	CO catalyst - DLN to be installed in 2013	Mechanical drive	62	NG 100	456	92	1985
163V	DE	MEGAL GmbH - Mittelbrunn MEGAL M1 - Mittelbrunn, RP	OCGT	DLN to be installed in 2014	Mechanical drive	26	NG 100	437	59	1985
164V	DE	NETG - St. Hubert M3 - St. Hubert, NRW	OCGT	DLN - CO catalyst	Mechanical drive	43	NG 100	21	NA	1974
165V	DE	MEGAL GmbH - Gernsheim MEGAL M4 - Gernsheim, HS	OCGT	DLN	Mechanical drive	33	NG 100	8	79	2009
166V	DE	E.ON Gas Storage GmbH - Bierwang M3 - Bierwang, BY	SG Engine	To be decommissioned	Mechanical drive	22	NG 100	1784	83	1985
167V	EL	Public Power Corporation S.A. - Meliti SES- Unit I	DBB	Air/Fuel staging - LNB - FGR - WFGD - ESP - Supercritical steam	NA	796	Lignite 100	6945	89	2003
168V	EL	Public Power Corporation S.A. - Aghios Dimitrios SES- Unit III	DBB	Air/Fuel staging - FGR - ESP - Pilot Duct Sorbent Injection	NA	828	Lignite 100	8744	91	1985
169V	EL	Public Power Corporation S.A. - Aghios Dimitrios SES- Unit V	DBB	Air/Fuel staging - FGR - ESP alone	NA	1047	Lignite 100	8417	95	1997

170V	EL	Public Power Corporation S.A. - Megalopoli B SES- Unit IV	DBB	FGR - WFGD - ESP	NA	908	Lignite 100	7755	82	1991
171aV	EL	Public Power Corporation S.A. - Lavrio - Unit IV - GT 4.1	CCGT	DLN	Power	374	NG 100	5026	80	1998
171bV	EL	Public Power Corporation S.A. - Lavrio - Unit IV - GT 4.2	CCGT	DLN	Power	374	NG 100	4274	79	1998
171cV	EL	Public Power Corporation S.A. - Lavrio - Unit IV - GT 4.3	CCGT	DLN	Power	374	NG 100	5473	79	1998
172V	EL	Public Power Corporation S.A. - Chania Power Station- Unit XII	OCGT	NA	Power	174	Gas oil 100	1163	62	1997
173aV	EL	Public Power Corporation S.A. - Chania Power Station CC - UNIT6+ 1/2 STEAM TURBINE	CCGT	NA	Power	149	Gas oil 100	6068	74	1992
173bV	EL	Public Power Corporation S.A. - Chania Power Station CC - UNIT7+ 1/2 STEAM TURBINE	CCGT	NA	Power	149	Gas oil 100	4788	75	1992
174V	EL	Public Power Corporation S.A. - Rhodes Power Station- Unit III	OCGT	Water injection	Power	63	Gas oil 100	2277	63	1996
175V	EL	Public Power Corporation S.A. - Atherinolakkos SES- Unit IV	Liquid B	LNB - Steam atomiser - ESP	Power	136	HFO 100	7737	72	2009
176V	EL	Public Power Corporation S.A. - Atherinolakkos SES- Unit II	Engine	NA	Power	112	HFO 100	6429	86	2004
177V	EL	Public Power Corporation S.A. - Lesvos- Unit 6	Engine	Fuel choice	Power	19	HFO 100	6909	78	1998
178V	EL	Public Power Corporation S.A. - Lesvos- Unit 8	Engine	Fuel choice	Power	28	HFO 100	6174	73	2009
179V	EL	Public Power Corporation S.A. - Lesvos- Unit 9	Engine	Fuel choice	Power	28	HFO 100	6391	69	2009

180V	EL	Public Power Corporation S.A. - Lesvos- Unit 10	Engine	Fuel choice	Power	26	HFO 100	6323	74	2000
181V	EL	Public Power Corporation S.A. - Lesvos- Unit 11	Engine	Fuel choice	Power	25	HFO 100	6940	65	1988
182V	EL	Heron II - Thiva	CCGT	DLN	Power	754	NG 100	8091	76	2010
183	HU	MVM Vertes Power Plant Ltd. - Vertesi Eromu - Oroszlany	WBB	NA	Power and district heating	165	Lignite 64 - Wood 30 - Straw 5 - Petrochemical residues 1	NA	NA	1963
184V	HU	Matrai Eromu ZRt. - Hungary Visonta, Eromu u 11.	WBB	LNB - Air staging - WFGD - ESP		2396	Lignite 84	8700	87	1969
185	HU	Sinergy Kft. - Furedi utca Gas Engine CHP - Budapest	SG Engine	NA	Power and district heating	42	NG 100	NA	NA	2005
186-1	HU	CHP-Erőmű Kft. - Ujpalotai Gas Engine Power Plant - Budapest	SG Engine	NA	Power and district heating	54	NG 100	5968	98	2005
187V	IE	Bord Gais Eireann - Whitegate Power Station - Whitegate, Cork	CCGT	DLN - Double reheat	Power	754	NG 100	6941	90	2010
188V	IE	Bord na Móna - Edenderry Power - Edenderry, Co Offaly	BFB	LNB - Air/Fuel staging - Sorbent injection - ESP	NA	293	Peat 89 - WB 11	7660	87	2000
189V	IE	ESB Energy International - ESB Moneypoint Unit 1 - Co Clare, Ireland	WBB	LNB - SCR - FGD CFB dry scrubber	Power	970	Coal 98 - HFO 2	6690	56	1986
190V	IE	ESB Energy International - ESB Lough Ree - Co Longford, Ireland	CFB	AS - SNCR - Sorbent injection - BF	Power	263	Peat 100	8178	89	2004
191V	IE	ESB Energy International - ESB Aghada CCGT - Co Cork, Ireland	CCGT	DLN - Emulsified fuel when running only on gas oil - Fuel preheating at 150 °C	Power	743	NG 100	3732	85	2010
192V	IE	Endesa Ireland Ltd. - Tarbert Unit 3 - Tarbert, County Kerry	Liquid B	NA	Power	641	HFO 100	2275	34	1976
193V	IE	Huntstown Power Company Ltd. - Huntstown Power	CCGT	DLN	Power	625	NG 100	6039	86	2001

		Station - Huntstown Quarry, Finglas, Dublin 11								
195V	IT	Abruzzoenergia SpA - Centrale a Ciclo Combinato di Gissi - Unit 1	CCGT	DLN - CO catalyst - Double reheat	Power	719	NG 100	1396	77	2008
196V	IT	Abruzzoenergia SpA - Centrale a Ciclo Combinato di Gissi - Unit 2	CCGT	DLN - CO catalyst - Double reheat	Power	719	NG 100	2591	75	2008
197VC	IT	E.ON Produzione S.p.A. - Centrale termoelettrica di Fiume Santo Unit 3 - Porto Torres (SS)	DBB	LNB - Air staging - FGR - SCR - WFGD - ESP	Power	800	Coal 98 - HFO 1.2 - FB 0.5	8112	86	1997
198VC	IT	E.ON Produzione S.p.A. - Centrale termoelettrica di Fiume Santo Unit 4 - Porto Torres (SS)	DBB	LNB - Air staging - FGR - SCR - WFGD -ESP	Power	800	Coal 94 - HFO 6	8256	83	1997
199V	IT	E.ON Produzione S.p.A. - Centrale termoelettrica di Fiume Santo Unit 1 - Porto Torres (SS)	WBB	Air staging - Fuel staging - Fuel choice	Power	2400	HFO 100	1717	28	1982
200V	IT	E.ON Produzione S.p.A. - Centrale termoelettrica di Fiume Santo Unit 2 - Porto Torres (SS)	WBB	Air staging - Fuel staging	Power	2400	HFO 100	2064	30	1984
201V	IT	E.ON Produzione S.p.A. - Centrale Termoelettrica Tavazzano - Montanaso TZ5 - Tavazzano con Villavesco - Montanaso Lombardo (LO)	CCGT	DLN	Power	1400	NG 100	3806	77	2004
202V	IT	E.ON Produzione S.p.A. - Centrale Termoelettrica Tavazzano - Montanaso TZ6 - Tavazzano con Villavesco - Montanaso Lombardo (LO)	CCGT	DLN	Power	700	NG 100	1245	82	2005
203V	IT	E.ON Produzione S.p.A. - Centrale Termoelettrica Tavazzano - Montanaso TZ8 - Tavazzano con	GasB	LNB - FGR - Air staging - ESP - Once-through direct cooling	Power	800	NG 100	1048	64	1992

		Villavesco - Montanaso Lombardo (LO)								
204V	IT	E.ON Produzione S.p.A. - Centrale turbogas di Trapani - GT1	OCGT	Ongoing revamping according to the BAT (Dry low-NO _x installation + turbine parts and compressor)	Power	290	NG 100	1112	66	1987
205V	IT	E.ON Produzione S.p.A. - Centrale turbogas di Trapani - GT2	OCGT	Ongoing revamping according to the BAT (Dry low-NO _x installation + turbine parts and compressor)	Power	290	NG 100	870	57	1988
206V	IT	Ergosud S.p.A. - Centrale termoelettrica di Scandale - SC1	CCGT	DLN - Double reheat	Power	720	NG 100	2520	90	2009
207V	IT	Ergosud S.p.A. - Centrale termoelettrica di Scandale - SC2	CCGT	DLN - Double reheat	Power	720	NG 100	1710	87	2009
208V	IT	Tirreno Power S.p.A. - Centrale termoelettrica "Napoli Levante" NA4 - Napoli	CCGT	DLN	Power	688	NG 100	4947	73	2008
209V	IT	A2A S.p.A. - Centrale termoelettrica di Cassano d'Adda - CC2TG5 - Cassano d'Adda (MI)	CCGT	DLN	Power	679	NG 100	4389	80	2003
210V	IT	A2A S.p.A. - Centrale termoelettrica di Cassano d'Adda - CC2TG6 - Cassano d'Adda (MI)	CCGT	DLN	Power	679	NG 100	4380	82	2006
211V	IT	A2A S.p.A. - Centrale termoelettrica di Monfalcone Unit1 - Monfalcone (GO)	DBB	LNB - Air staging - WFGD - ESP	Power	418	Coal 92 - Waste 6	6275	95	1965
212V	IT	A2A S.p.A. - Centrale termoelettrica di Monfalcone Unit2 - Monfalcone (GO)	DBB	LNB - Air staging - WFGD - ESP	Power	433	Coal 91 - Solid waste 6	6672	93	1970
213V	IT	A2A Calore & Servizi - Centrale LAMARMORA di	DBB	LNB - Air staging - SCR - ESP - SDA - BF	Power and district heating	200	Coal 93	3661	78	1988

		Brescia - Unit3								
214V	IT	IREN ENERGIA S.p.A. - Centrale termoelettrica Torino Nord - Gruppo Termoelettrico a ciclo combinato	CCGT	DLN - SCR - Cooled inlet air	Power and district heating	698	NG 100	1002	82	2011
215V	IT	IREN ENERGIA S.p.A. - Centrale termoelettrica Torino Nord - Caldaie di Integrazione e Riserva	GasB	LNB - Fuel staging - Closed dry cooling + district heating	Power	128	NG 100	NA	NA	2011
219V	IT	Enel Produzione S.p.A. - Impianto termoelettrico di Fusina - FS4 - Venezia (VE)	DBB	LNB - Air/Fuel staging - SCR - WFGD - ESP - BF	Power	793	Coal 95 - Solid waste 2	5937	84	1974
221VC	IT	Enel Produzione S.p.A. - Impianto termoelettrico di Fusina - FS2 - Venezia (VE)	DBB	Air staging - SCR - WFGD - BF	Power	431	Coal 98	4993	83	1969
223V	IT	Enel Produzione S.p.A. - Impianto termoelettrico di Portoscuso - SU3	DBB	LNB - SCR - WFGD - ESP	Power	670	Coal 84	5096	67	1986
224V	IT	Enel Produzione S.p.A. - Impianto termoelettrico di Portoscuso - SU2	CFB	SNCR - Boiler sorbent injection - BF - WFGD	Power	800	Coal 82 - Wood 17	7027	25	2006
225V	IT	Enel Produzione S.p.A. - Impianto termoelettrico di Montalto di Castro MC41 - Montalto (VT)	GasB	LNB - SCR - ESP	Power	1610	HFO 32 - NG 66	654	64	1998
229V	IT	Enel Produzione S.p.A. - Impianto termoelettrico di Montalto di Castro MC43 - Montalto (VT)	OCGT	Water injection	Power	430	NG 100	96	74	1992
241V	IT	Enel Produzione S.p.A. - Impianto G. Ferraris di Leri - Trino Unit1 - Trino Vercellese (VC)	CCGT	DLN (1996)	Power	860	NG 100	121	59	1996
245V	IT	Enel Produzione S.p.A. - Centrale a ciclo combinato di Porto Corsini F1 -	CCGT	DLN - Double reheat	Power	645	NG 100	4714	90	2002

		Ravenna (RA)								
248V	IT	Enel Produzione S.p.A. - Centrale Santa Barbara Gruppo3 E1 - Cavriglia (AR)	CCGT	DLN - Double reheat	Power	680	NG 100	3112	78	2006
249V	IT	Enel Produzione S.p.A. - Centrale termoelettrica "Ettore Majorana"-Termini Imerese - c3	CCGT	DLN - Double reheat	Power	645	NG 100	7754	80	2005
251V	IT	Enel Produzione S.p.A. - Centrale termoelettrica "Ettore Majorana"-Termini Imerese - c6	OCGT	Standard combustion - Automatic regulation	Power	430	NG 100	256	70	1995
253V	IT	Enel Produzione S.p.A. - Torrevaldaliga Nord - Civitavecchia (RM)	DBB	Air/Fuel staging - LNB - SCR - WFGD - BF - Supercritical steam	Power	1420	Coal 100	8136	98	2008
256V	IT	Edipower S.p.A. - Centrale termoelettrica di Piacenza - PZ41	CCGT	DLN	Power	768	NG 100	3618	72	2005
257V	IT	Edipower S.p.A. - Centrale termoelettrica di Piacenza - PZ42	CCGT	DLN	Power	768	NG 100	4583	72	2005
258V	IT	Edipower S.p.A. - Centrale termoelettrica di San Filippo del Mela - SF1	Liquid B	ESP - WFGD - Air staging - FGR - SCR	Power	417	HFO 100	5583	60	1971
259V	IT	Edipower S.p.A. - Centrale termoelettrica di San Filippo del Mela - SF2	Liquid B	ESP - WFGD - Air staging - FGR - SCR	Power	417	HFO 100	3325	64	1971
260V	IT	Edipower S.p.A. - Centrale termoelettrica di San Filippo del Mela - SF3	Liquid B	Air staging - FGR - ESP - Fuel choice	Power	417	HFO 100	2062	58	1972
261V	IT	Edipower S.p.A. - Centrale termoelettrica di San Filippo del Mela - SF4	Liquid B	Air staging - FGR - ESP - Fuel choice	Power	417	HFO 100	2707	55	1973
262V	IT	Edipower S.p.A. - Centrale termoelettrica di San Filippo del Mela - SF5	Liquid B	ESP - WFGD - Steam injection - Air staging - FGR - SCR	Power	798	HFO 100	2397	67	1975
263V	IT	Edipower S.p.A. - Centrale termoelettrica di San	Liquid B	ESP - WFGD - Steam injection - Air staging - FGR	Power	798	HFO 100	1560	69	1975

		Filippo del Mela - SF6		- SCR						
264V	IT	Edipower S.p.A. - Centrale termoelettrica di Sermide - 3E	CCGT	DLN	Power	684	NG 100	1156	80	2003
265V	IT	Edipower S.p.A. - Centrale termoelettrica di Sermide - 4G	CCGT	DLN	Power	684	NG 100	5201	76	2004
266V	IT	Edipower S.p.A. - Centrale termoelettrica di Sermide - 4H	CCGT	DLN	Power	684	NG 100	4794	77	2004
267V	IT	Edipower S.p.A. - Brindisi - BR3	WBB	FGR - SCR - Balanced air flow - Low-S coal - ESP	Power	857	Coal 96 - HFO 4	3421	69	74
268V	IT	Edipower S.p.A. - Brindisi - BR4	WBB	FGR - SCR - Balanced air flow - Low-S coal - ESP	Power	857	Coal 97 - HFO 3	2992	68	1977
269V	IT	Edison S.p.A - Centrale termoelettrica di Candela	CCGT	DLN	Power and district heating	670	NG 100	7079	90	2005
270V	IT	Edison S.p.A - Marghera Levante - Marghera (VE) - TG3	CCGT	Steam injection	Chemical industry	393	NG 100	1731	79	1992
271V	IT	Edison S.p.A - Marghera Levante - Marghera (VE) - TG4	CCGT	Steam injection	Chemical industry	393	NG 100	1037	82	1992
272V	IT	Edison S.p.A - Marghera Levante - Marghera (VE) - TG5	CCGT	DLN	Chemical industry	669	NG 100	7957	75	2001
273V	IT	ROSEN Rosignano Energia S.p.A. - Centrale di Rosignano TG1 - Rosignano Marittimo (LI)	CCGT	DLN	Chemical industry	449	NG 100	8314	93	1997
274V	IT	ROSEN Rosignano Energia S.p.A. - Centrale di Rosignano TG2 - Rosignano Marittimo (LI)	CCGT	DLN	Chemical industry	449	NG 100	7322	94	1997
275V	IT	SEF s.r.l - Centrale a ciclo combinato CC1 - Ferrara (FE)	CCGT	Tuned DLN alone - Enhanced airflow capability for wider load range	Power	683	NG 100	4396	79	2008

276V	IT	SEF s.r.l - Centrale a ciclo combinato CC2 - Ferrara (FE)	CCGT	Tuned DLN alone - Enhanced airflow capability for wider load range	Power	683	NG 100	6995	76	2008
278V	IT	Enipower S.p.A. - Centrale termoelettrica di Brindisi - CC1	CCGT	Tuned DLN alone - Enhanced airflow capability for wider load range	Chemical industry	685	NG 100	5007	77	2005
279V	IT	Enipower S.p.A. - Centrale termoelettrica di Brindisi - CC2	CCGT	DLN	Chemical industry	685	NG 95 - Steam cracking off-gas (H ₂) 5	8177	84	2005
280V	IT	Enipower S.p.A. - Centrale termoelettrica di Brindisi - CC3	CCGT	DLN	Chemical industry	685	NG 95 - Steam cracking off-gas (H ₂) 5	7546	83	2007
286V	IT	Enel Produzione S.p.A. - Pietro Vanucci Gruppo 1 - Gualdo Cattaneo (PG)	DBB	LNB - Air staging - ESP	Power	200	Coal 96	3089	81	1990
288V	IT	Enel Produzione S.p.A. - Bari - GR2	GasB	LNB - Air staging	Power	180	NG 100	738	75	1959
290V	IT	Enel Produzione S.p.A. - Porto Empedocle gr1	Liquid B	Steam injection - LNB - FGR - Fuel choice	Power	200	HFO 100	4439	59	1963
292V	IT	Termica Cologno s.r.l - Cologno Monzese (MI)	CCGT	DLN	Pulp and paper	112	NG 100	7124	90	1997
293V	IT	Edison S.p.A - Terni - CCGT	CCGT	DLN	Chemical industry	190	NG 100	6600	87	2004
294V	IT	Edison S.p.A - Terni - Auxiliary boiler	GasB	Standard burners	Chemical industry	74	NG 100	2168	40	2001
295V	IT	Edison S.p.A - Marghera Azotati TG3 - Marghera (Venezia)	CCGT	Water injection - CO catalyst in bypass stack (when used in Open Cycle) and before HRSG (when used in Combined Cycle)	Power	235	NG 100	1004	73	2010
296V	IT	Edison S.p.A - Marghera Azotati TG4 - Marghera (Venezia)	CCGT	Water injection - CO catalyst in bypass stack (when used in Open Cycle) and before HRSG (when used in Combined Cycle)	Power	235	NG 100	1901	82	2009
297V	IT	Polimeri Europa S.p.A. - SA1-B4 - Porto Marghera (VE)	Boiler	Fuel choice - LNB - Air staging - Double reheat	Chemical industry	278	Liquid process fuel 66.6 - NG 21.2 - Gaseous process fuel	4066	28	1966

							17			
298V	IT	Polimeri Europa S.p.A. - Porto Marghera (VE)	DBB	Fuel choice - Low-ash fuel - LNB - Air staging - Double reheat	Chemical industry	139	Liquid process fuel 64 - NG 19 - Gaseous process fuel 17	7158	72	1966
305V	IT	FENICE S.p.A - Pedrignano (PR)	CCGT	DLN	CHP	91	NG 100	NA	NA	2008
307V	IT	Società ionica gas S.p.A. - 360-KA-503 - Crotona (KR)	CCGT	DLN	Mechanical drive	18	NG 100	8400	84	2004
311V	IT	Società ionica gas S.p.A. - 3601-KA-001 - Crotona (KR)	CCGT	DLN	Mechanical drive	21	NG 100	8400	67	2010
313V	IT	Eni e&p - Distretto Meridionale Centro Olio Val D'agri Gas Turbine V470-MT-001A & HRSG V620-VC-001A - Viggiano (PZ)	CCGT	DLN	GOSP (Gas oil separation plant)	43	NG 75 - Off-gas oil storage to HRSG 25	6739	89	2001
314V	IT	Eni e&p - Distretto Meridionale Centro Olio Val D'agri Gas Turbine V470-MT-001B & HRSG V620-VC-001B - Viggiano (PZ)	CCGT	DLN	GOSP (Gas oil separation plant)	43	NG 75 - Off-gas oil storage to HRSG 25	5557	88	2001
315V	IT	Eni e&p - Distretto Meridionale Centro Olio Val D'agri Gas Turbine V470-MT-001C & HRSG V620-VC-001C - Viggiano (PZ)	CCGT	DLN	GOSP (Gas oil separation plant)	43	NG 75 - Off-gas oil storage to HRSG 25	5492	88	2001
317V	IT	Eni e&p - Distretto Meridionale Centro Olio Val D'agri V620-FG.001 B - Viggiano (PZ)	GasB	LNB	GOSP (Gas oil separation plant)	66	Gaseous process fuel	8559	36	2004
318V	IT	Eni e&p - Distretto Meridionale Centro Olio Val D'agri V620-FG.001 C - Viggiano (PZ)	GasB	LNB	GOSP (Gas oil separation plant)	66	Gaseous process fuel	8471	36	2004

319	IT	Eridania Sadam S.p.A. - Trecasali (PR)	GasB	LNB - Air staging	Power	200	NG 100	1512	77	1968
322V	IT	SICET S.r.L. - Ospitale di Cadore (BL)	BFB	AS - FGR	Power	63	WB 100	6067	93	2011
323V	IT	Ahlstrom Turin SpA - 1 - Mathi (TO)	CCGT	DLN (New GT 2008) - Standard burners (HRSG 1990)	Pulp and paper	67	NG 100	8190		1990
325V	IT	Ahlstrom Turin SpA - 3 - Mathi (TO)	GasB	Fuel staging - FGR	Pulp and paper	63	NG 100	8483	31	2000
326V	IT	Ahlstrom Turin SpA - 4 - Mathi (TO)	GasB	LNB	Pulp and paper	18	NG 100	550	44	2007
328V	IT	Cartiere Modesto Cardella S.p.A. - 1 - Lucca (LU)	CCGT	DLN (GT)	Pulp and paper	57	NG 100	8000	57	1997
330V	IT	Eni e&p - Distretto centro settentrionale - Piattaforma Barbara T2 - 1 - 360-MT-004 - Adriatic Sea, in front of Marche Region	OCGT	DLN	Mechanical drive on offshore platform	13	NG 100	8220	97	2001
331V	IT	Eni e&p - Distretto centro settentrionale - Piattaforma Barbara T2 - 1 - 360-MT-005 - Adriatic Sea, in front of Marche Region	OCGT	DLN	Mechanical drive on offshore platform	13	NG 100	8220	96	2001
332V	IT	Eni e&p - Distretto centro settentrionale - Piattaforma Barbara T2 - 1 - 360-MT-006 - Adriatic Sea, in front of Marche Region	OCGT	DLN	Mechanical drive on offshore platform	13	NG 100	8220	104	2001
333V	IT	Eni e&p - Distretto centro settentrionale - Piattaforma Barbara T2 - 1 - 360-MT-007 - Adriatic Sea, in front of Marche Region	OCGT	DLN	Mechanical drive on offshore platform	13	NG 100	8220	102	2001
334V	IT	Snam Rete Gas - Enna (EN) - TC1 PGT25	OCGT	Control of speed, inlet temperature, degrees of variable stage vanes	Mechanical drive	56	NG 100	866	77	1984
335V	IT	Snam Rete Gas - Enna (EN) - TC4 PGT25-DLE	OCGT	DLN	Mechanical drive	64	NG 100	2040	72	2008

336V	IT	Snam Rete Gas - Messina (ME) - TC6 PGT25plus-DLE	OCGT	DLN	Mechanical drive	76	NG 100	4163	89	2006
337V	IT	Snam Rete Gas - Malborghetto (UD)	CCGT	Control of speed, inlet temperature, degrees of variable stage vanes	Mechanical drive	31	NG 100	700	73	1976
338V	IT	Snam Rete Gas - Malborghetto (UD)	OCGT	DLN	Mechanical drive	62	NG 100	1131	73	1997
339V	IT	Snam Rete Gas - Masera (VB)	OCGT	DLN	Mechanical drive	36	NG 100	130	85	2002
340V	IT	Snam Rete Gas - Poggio Renatico (FE)	OCGT	DLN	Mechanical drive	33	NG 100	2235	91	2008
341V	IT	Snam Rete Gas - Poggio Renatico (FE)	OCGT	DLN	Mechanical drive	64	NG 100	1205	91	2008
342V	IT	STOGIT - Ripalta Cremasca (CR)	OCGT	DLN	Mechanical drive	62	NG 100	801	86	1998
343V	IT	STOGIT - Ripalta Cremasca (CR)	OCGT	DLN	Mechanical drive	62	NG 100	1802	85	1998
344V	IT	STOGIT - Tresigallo (FE)	OCGT	Control of the air/fuel ratio	Mechanical drive	41	NG 100	923	90	1984
353V	IT	INTERECOGEN S.r.l - S.Croce sull'Arno (PI)	SG Engine	Lean-burn concept - SCR	Power	30	NG 100	3788	67	2010
354V	IT	INTERECOGEN S.r.l - S.Croce sull'Arno (PI)	SG Engine	Lean-burn concept - SCR	Power	37	NG 100	3848	67	2010
358AV	IT	Taranto Energia SrL - (CET 2)	GasB	Combined burners (LDG, AFO, coke, NG and fuel oil) - Double reheat	Iron & Steel	427	NG 70 - BF 26 - COG 4	5229	81	1973
358BV	IT	Taranto Energia SrL - (CET 2)	GasB	Combined burners LNB (retrofit) - Double reheat	Iron & Steel	427	NG 68 - BF 29 - COG 3	6728	83	1974
358CV	IT	Taranto Energia SrL - (CET 2)	GasB	Combined burners LNB (retrofit) - Double reheat	Iron & Steel	427	NG 67 - BF 29 - COG 3 - HFO 1	8475	84	1975
359AV	IT	Taranto Energia SrL - (CET 3)	CCGT	Steam injection when using NG - Double reheat - Dust in BFG pre-removed	Iron & Steel	441	BF 39 - NG 38 - COG 22 - BOF 2	8123	96	1996

359BV	IT	Taranto Energia SrL - (CET 3)	CCGT	Steam injection when using NG - Double reheat - Dust in BFG pre-removed	Iron & Steel	441	BF 39 - NG 38 - COG 22 - BOF 2	8163	98	1996
359CV	IT	Taranto Energia SrL - (CET 3)	CCGT	Steam injection when using NG - Double reheat - Dust in BFG pre-removed	Iron & Steel	441	BF 39 - NG 38 - COG 22 - BOF 2	7514	96	1996
360V	IT	Edison S.p.A - Piombino (LI)	CCGT	Steam injection when using NG	Iron & Steel	383	NG 59 - BF 29 - COG 12	8022	100	2001
361V	IT	Edison S.p.A - Piombino (LI)	GasB	Combined burners (oil and 3 types of gas) - Liquid fuel (S content 1.5 %)	Iron & Steel	221	BF 44 - NG 26 - HFO 26 - COG 4	8760	42	1978
362	MT	Combined Cycle Diesel Engines - Delimara	Engine	SCR - DSI - BF	Power	77	HFO 100	512	97	2012
363	MT	Combined Cycle Diesel Engines - Delimara	Engine	SCR - DSI - BF	Power	77	HFO 100	566	97	2012
364	MT	Combined Cycle Diesel Engines - Delimara	Engine	SCR - DSI - BF	Power	77	HFO 100	458	97	2012
365	MT	Combined Cycle Diesel Engines - Delimara	Engine	SCR - DSI - BF	Power	77	HFO 100	602	97	2012
366V	NL	Essent - Amer-9	WBB	LNB - Air staging - SCR - WFGD - ESP - Supercritical steam	NA	1600	Coal 70 - Wood 30	8116	85	1995
367V	NL	E.on - Maasvlakte-1	WBB	LNB - Air staging - SCR - type FGD - ESP	Power	1384	Coal 85 - Wood 15	7621	65	1987
368V	NL	EPZ - Borssele-12	WBB	LNB - Air staging - SCR - Fuel staging - WFGD - ESP	Power	1080	Coal 100	7891	84	1987
369V	NL	Intergen - Maasstroom (Rijnmond 2)	CCGT	DLN - SCR	Power	742	NG 100	6240	63	2010
370V	NL	GDF SUEZ - Eems-1v5	CCGT	DLN	Power	688	NG 100	3581	77	1996
371V	NL	Essent - Den Bosch	CCGT	DLN	Food & Drink	69	NG 100	4364	93	1995
372V	NL	E.on - UCML - Rotterdam-Maasvlakte	CCGT	DLN	Chemical industry	NA	NG and Glycol in HRSG	NA	NA	NA

373V	NL	Nuon - IJmond-1 - Ijmuiden	CCGT	DLN	Iron & Steel	347	BF 96 - NG 1 - BOF 2	6445	92	1997
374V	NL	EDEA - F-3501 - Sittard - Geleen	GasB	LNB - FGR - Fuel choice	Chemical industry	140	Process gases 100	8100	72	1978
375V	NL	Nuon - WKC2 Emmtec - Emmen	CCGT	Steam injection	NA	141	NG 100	7625	28	2003
376NV	PL	Dalkia Poznań SA - EC II Karolin	DBB	Reported air emissions data for one boiler of the four: ESP - SDA - BF	Power and district heating	920	Coal 96 - WBB 1.4 - Herbaceous 1.1	8760	NA	NA
377V	PL	TAURON Wytwarzanie SA - EC Katowice	PCFB	Air staging - Boiler sorbent injection - ESP	Power and district heating	378	Coal 92 - Sludge 8	7807	80	1999
378V	PL	EC Białystok SA - Białystok	BFB	Air/Fuel staging - FGR - ESP	Power and district heating	87	WB 100	7874	107	1978
379V	PL	KOGENERACJA SA - EC Wrocław	WBB	LNB - Air staging - Fuel staging - Planned additional DeNO _x improvements and Desulphurisation in 2015	Power and district heating	186	Coal 57 - Wood 43	6571	89	1972
380V	PL	EC Kraków SA	WBB	LNB - Air staging - Double reheat	Power and district heating	331	Coal 89 - HB 12	6113	92	1978
381V	PL	Dalkia Łódź SA	DBB	LNB - Air/Fuel staging	Power and district heating	360	Coal 95 - Wood 2 - Herbaceous 3	4118	45	1977
382V	PL	EC Zielona Góra SA	CCGT	DLN	Power and district heating	383	NG 100	7417	89	2004
383V	PL	PGE Górnictwo i Energetyka Konwencjonalna SA - EC Lublin Wrotków	CCGT	DLN	Power and district heating	488	NG 100	5845	87	2002
384-1V	PL	Tauron Wytwarzanie SA - Jaworzno III	DBB	LNB - Air staging - Double reheat	Power	3360	Coal 99	5927	90	1976
384-2V	PL	Tauron Wytwarzanie SA - Jaworzno III, Elektrownia III	DBB	LNB - Air staging	Power	3360	Coal 99	5927	90	1976
384-3V	PL	Tauron Wytwarzanie SA - Jaworzno III, Elektrownia III	DBB	LNB - Air staging	Power	3360	Coal 99	5927	90	1976

385V	PL	TAURON Wytwarzanie Spółka Akcyjna - Oddział Elektrownia Jaworzno III w Jaworznie - Elektrownia II	CFB	Lighting up burners + Air staging - ESP - Planned retrofit for NO _x flue-gas recirculation (10 %)	Power	396	Coal 89 - Herbaceous 11	7627	92	2002
386-1V	PL	PGE Elektrownia Opole SA -	DBB	LNB - Air staging - WFGD - ESP - Double reheat	Power	952	Coal 98	4923	81	1993
386-2V	PL	Tauron Wytwarzanie SA - Jaworzno III, Elektrownia III	DBB	LNB - Air staging - WFGD - ESP - Double reheat	Power	952	Coal 98	6551	83	1994
386-3V	PL	PGE Elektrownia Opole SA	DBB	LNB - Air staging - WFGD - ESP - Double reheat	Power	952	Coal 98	6924	81	1996
386-4V	PL	PGE Elektrownia Opole SA	DBB	LNB - Air staging - WFGD - ESP - Double reheat	Power	952	Coal 98	7453	81	97
387VC	PL	Tauron Wytwarzanie SA - Elektrownia Łagisza	CFB	SNCR - Boiler sorbent injection - ESP - Supercritical steam	Power	1022	Coal 100	6217	78	2009
388NV	PL	Enea SA - Elektrownia Kozienice	DBB	LNB - Air staging - WFGD - ESP	Power and district heating	1383	Coal 100	5046		1979
389VC	PL	PGE Górnictwo i Energetyka Konwencjonalna SA - Elektrownia Bełchatów	DBB	WFGD - ESP	Power	991	Lignite 100	8104	91	1986
390-1V	PL	PGE Górnictwo i Energetyka Konwencjonalna SA - Elektrownia Turów	CFB	Air staging - Boiler sorbent injection - ESP	Power and district heating	587	Lignite 100	7081	85	1998
390-2V	PL	PGE Górnictwo i Energetyka Konwencjonalna SA - Elektrownia Turów	CFB	Air staging - Boiler sorbent injection - ESP	Power and district heating	587	Lignite 100	7172	86	1998
390-3V	PL	PGE Górnictwo i Energetyka Konwencjonalna SA - Elektrownia Turów	CFB	Air staging - Boiler sorbent injection - ESP	Power and district heating	587	Lignite 100	7200	83	2000
390-4V	PL	PGE Górnictwo i Energetyka Konwencjonalna SA - Elektrownia Turów	CFB	Air staging - Boiler sorbent injection - ESP	Power and district heating	611	Lignite 100	8224	86	2003

390-5V	PL	PGE Górnictwo i Energetyka Konwencjonalna SA - Elektrownia Turów	CFB	Air staging - Boiler sorbent injection - ESP	Power and district heating	611	Lignite 93 - WBB 4 - Herbaceous 3	5919	85	2003
390-6V	PL	PGE Górnictwo i Energetyka Konwencjonalna SA - Elektrownia Turów	CFB	Air staging - Boiler sorbent injection - ESP	Power and district heating	611	Lignite 93 - WBB 4 - Herbaceous 3	7774	84	2004
391V	PL	ZE PAK SA - Elektrownia Pątnów II	DBB	Air/Fuel staging - FGR - WFGD - ESP	NA	1080	Lignite 100	7724	71	2007
395V	PL	ArcelorMittal Poland S.A. - Elektrociepłownia - Zdzeszowice	GasB	LNB separate burners (COG/coal) - Rotary air heater - Double reheat	Iron & Steel	330	COG 95	8704	74	1975
398NV	PL	International Paper - Kwidzyn sp. z o.o.	BFB	Air staging	NA	84	Bark 11.55 - Forest R 0.014 - Herb 0.152 - Other solids 0.815	8296	100	1990
399NV	PL	International Paper - Kwidzyn -	DBB	LNB - Air staging - ESP - Planned FGD retrofit	NA	363	Coal 44	6809	100	
402NV	PL	EC Nowa Sp. z o.o.	DBB	LNB separate burners (Coal-COG/Other gases) - Double reheat	Iron & Steel	1608	BF 51 - C 40 - COG 7 - BOF 2	8760	32	1976
404V	PL	Przedsiębiorstwo Energetyki Ciepłej - Gliwice Sp. z o.o.	DBB	LNB - Air/Fuel staging - FGR	District heating	98	Coal 100	1422	69	1985
405VC	PL	Miejska Energetyka Ciepła Sp. z o.o. Koszalin	DBB	Air staging - two-stage dust removal cyclones	Iron & Steel	35	Coal 100	4684	58	1988
406V	PL	Przedsiębiorstwo Energetyki Ciepłej "Legionowo" Sp. z o.o.	GB	FGR - Battery of 4 cyclones	District heating	153	Coal 100	4266	12	1977
407V	PL	Przedsiębiorstwo Energetyki Ciepłej w Suwałkach Sp. z o.o.	DBB	Air/Fuel staging - ESP	Power and district heating	23	Coal 100	8500		2008
411V	PL	PGE Górnictwo i Energetyka Konwencjonalna S.A. - Oddział Elektrociepłownia Kielce	GB	FS - FGR	Power and district heating	25	WB Chips 100	4904	79	2009
412-1V	PL	Szczecińska Energetyka Ciepła Sp. z o.o.	Boiler	LNB - Fuel choice	District heating	36	Gas oil 98 - NG 2	61	71	2004

412-2V	PL	Szczecińska Energetyka Ciepła Sp. z o.o.	Boiler	LNB - Fuel choice	NA	36	Gas oil 95 - NG 5	30	80	2004
414VC	PL	PGE Górnictwo i Energetyka Konwencjonalna S.A. - Oddział Elektrociepłownia Zgierz	BFB	LNB - Air/Fuel staging - FGR - Low S content (0.6 %) - ESP alone	NA	78	Lignite 88 - Wood 12	4618	54	1987
415-1V	PT	Central Termoelétrica do Pego, Abrantes	WBB	LNB - Air staging - SCR - WFGD - ESP	Power	816	Coal 100	5534	73	1992
415-2V	PT	Central Termoelétrica do Pego, Abrantes	WBB	LNB - Air staging - SCR - WFGD - ESP	Power	816	Coal 100	5131	72	1995
416-1V	PT	Central Termoelétrica do Ribatejo, Carregado	CCGT	DLN	Power	682	NG 100	3163	81	2003
416-2V	PT	Central Termoelétrica do Ribatejo, Carregado	CCGT	DLN	Power	682	NG 100	2953	82	2004
416-3V	PT	Central Termoelétrica do Ribatejo, Carregado	CCGT	DLN	Power	682	NG 100	4316	82	2005
417-1V	PT	Central de Ciclo Combinado da Tapada do Outeiro, Medas, Gondomar	CCGT	DLN	Power	605	NG 100	4943	82	1999
417-2V	PT	Central de Ciclo Combinado da Tapada do Outeiro, Medas, Gondomar	CCGT	DLN	Power	605	NG 100	6286	86	1999
417-3V	PT	Central de Ciclo Combinado da Tapada do Outeiro, Medas, Gondomar	CCGT	DLN	Power	605	NG 100	6941	85	1999
418V	PT	Central de Cogeração da Energin, Póvoa de Sta. Iria, Vila Franca de Xira	CCGT	DLN (GT) + LNB (SF)	Chemical industry	153	NG 100	7626	84	2002
419-1V	PT	Central de Cogeração da SPCG, Sado, Setúbal	CCGT	DLN (GT) + LNB (SF)	Pulp and paper	106	NG 100	6571	93	2009
419-2V	PT	Central de Cogeração da SPCG, Sado, Setúbal	CCGT	DLN (GT) + LNB (SF)	Pulp and paper	106	NG 100	7871	83	2009
421-1V	PT	Powercer - Sociedade de Cogeração de Vialonga, S.A - Central de Cogeração da Powercer, Vialonga,	CCGT	DLN (GT) + LNB (SF)	Food & Drink	34	NG 100	6901	61	2004

		Vila Franca de Xira								
421-2V	PT	Powercer - Sociedade de Cogeração de Vialonga, S.A - Central de Cogeração da Powercer, Vialonga, Vila Franca de Xira	GasB	LNB	Food & Drink	26	NG 100	1314	NA	1971
421-3V	PT	Powercer - Sociedade de Cogeração de Vialonga, S.A - Central de Cogeração da Powercer, Vialonga, Vila Franca de Xira	GasB	LNB	Food & Drink	61	NG 94 - Biogas 6	1635	NA	2004
423V	PT	Central Termoeléctrica a Biomassa da Figueira da Foz	BFB	LNB - FGR - ESP	NA	95	Bark 99.7	8271	NA	2009
424-1V	PT	Caldeira Auxiliar a Biomassa (BB - Biomass Boiler)	BFB	LNB - AS - FGR - ESP	NA	99	Bark 87 - HFO 6 - NG 7	7994	38	1990
424-2V	PT	Caldeiras auxiliares a biomassa e fuelóleo, Cacia, Figueira da Foz	BFB	LNB - AS - FGR - ESP	NA	50	WB 96	7647	77	2009
425-1V	PT	Central Termoeléctrica Sines	GasB	LNB - Air staging	Chemical industry	178	Gaseous process fuel (32+5) - NG 28 - Liquid process fuel 31 - HFO 4	8760	85	1980
425-2V	PT	Central Termoeléctrica Sines	GasB	LNB - Air staging	Chemical industry	357	NG 35 - Liquid process fuel 32 - Gaseous process fuel 32 - HFO 3	8760	43	1980
427-1V	PT	Central Termoeléctrica do Caldeirão - Group 1	Engine	NA	Power	20	HFO 100	643	56	1987
427-2V	PT	Central Termoeléctrica do Caldeirão - Group 2	Engine	NA	Power	20	HFO 100	843	61	1987
427-3V	PT	Central Termoeléctrica do Caldeirão - Group 3	Engine	NA	Power	20	HFO 100	1671	55	1990
427-4V	PT	Central Termoeléctrica do Caldeirão - Group 4	Engine	NA	Power	20	HFO 100	2701	60	1993

427-5V	PT	Central Termoelétrica do Caldeirão - Group 5	Engine	Low-NO _x combustion concept	Power	44	HFO 100	4405	63	2002
427-6V	PT	Central Termoelétrica do Caldeirão - Group 6	Engine	Low-NO _x combustion concept	Power	44	HFO 100	5466	64	2002
427-7V	PT	Central Termoelétrica do Caldeirão - Group 7	Engine	Low-NO _x combustion concept	Power	44	HFO 100	3112	62	2002
427-8V	PT	Central Termoelétrica do Caldeirão - Group 8	Engine	Low-NO _x combustion concept	Power	44	HFO 100	5523	63	2002
428-5V	PT	Central Termoelétrica do Belo jardim - Group 5	Engine	NA	Power	16	HFO 100	6874	69	2003
428-6V	PT	Central Termoelétrica do Belo jardim - Group 6	Engine	NA	Power	16	HFO 100	5841	69	1997
428-7V	PT	Central Termoelétrica do Belo jardim - Group 7	Engine	NA	Power	16	HFO 100	3765	53	1997
428-8V	PT	Central Termoelétrica do Belo jardim - Group 8	Engine	NA	Power	16	HFO 100	3725	69	1997
428-9V	PT	Central Termoelétrica do Belo jardim - Group 9	Engine	NA	Power	32	HFO 100	8568	66	2004
428-10V	PT	Central Termoelétrica do Belo jardim - Group 10	Engine	NA	Power	32	HFO 100	2993	66	2004
429-1V	PT	Central Térmica da Vitória - Group 6	Engine	No abatement techniques	Power	20	HFO 100	1766	64	1984
429-2V	PT	Central Térmica da Vitória - Group 11	Engine	No abatement techniques	Power	30	HFO 100	7495	58	1992
429-3V	PT	Central Termoelétrica da Vitória, Madeira - Funchal	OCGT	NA	Power	41	Gas oil 95	96	88	2004
429-4V	PT	Central Térmica da Vitória III - Group 19	Engine	SCR	Power	40	HFO 100	1978	73	2010
430VC	PT	Central Termoelétrica do Caniçal	Engine	No abatement techniques	Power	72	HFO 100	8760	74	2000
431V	ES	Central GICC, Puertollano (Ciudad Real)	CCGT	IGCC - Water injection and lean-burn mode	Power	726	Coke 75 - Coal 25	5325	85	1998

432NV	ES	GDF SUEZ - Castelnou Energía	CCGT	Emulsified fuel	Power		NG 100	3332	NA	2006
433V	ES	Castellon 4, Castellón	CCGT	DLN alone - Double reheat	Power	1501	NG 100	6600	50	2008
434V	ES	Velilla 2, Velilla del Río Carrión (Palencia)	WBB	LNB - Air staging - WFGD - ESP	Power	1016	Coal 99.7 - Coke 0.3	6110	86	1984
435-1V	ES	CT La Robla, La Robla (León)	WBB	ESP	Power	822	Coal 100	695	85	1971
435-2V	ES	CT La Robla, La Robla (León)	WBB	LNB - Air staging - WFGD - ESP	Power	1024	Coal 100	2771	81	1984
436-1V	ES	CTCC Sagunto Polígono Industrial del Puerto (Polígono Químico) (Valencia)	CCGT	DLN	Power	732	NG 100	6503	79	2007
436-2V	ES	CTCC Sagunto Polígono Industrial del Puerto (Polígono Químico) (Valencia)	CCGT	DLN	Power	736	NG 100	6817	79	2007
436-3V	ES	CTCC Sagunto Polígono Industrial del Puerto (Polígono Químico) (Valencia)	CCGT	DLN	Power	734	NG 100	6404	80	2007
437V	ES	CT PUENTE NUEVO, ESPIEL (CÓRDOBA)	WBB	LNB - Air/Fuel staging - FGR-type FGD - ESP	Power	872	Coal 100	4597	84	1981
438V	ES	CT LOS BARRIOS (CÁDIZ)	DBB	Air /Fuel staging - Flexicom system (fuel distribution) - FGD - ESP	Power	1645	Coal 100	6218	61	1985
439V	ES	CCGT ESCATRÓN (ZARAGOZA)	CCGT	DLN - Double reheat	Power	1384	NG 100	6453	68	2008
440V	ES	Soto 4, Rivera de Arriba	CCGT	DLN - Emulsified fuel (in case of dual fuel)	Power	747	NG 100	6111	58	2008
441-1V	ES	CT Aboño, Gijón	WBB	LNB Separate burners - ESP alone - DCS	Iron & Steel	1094	Coal 75 - BF 20 - COG 5	4832	61	NA
441-2V	ES	CT Aboño, Gijón	DBB	LNB Separate burners - WFGD - ESP - DCS	Iron & Steel	1570	Coal 75 - BF 20 - COG 5	8622	68	NA

442V	ES	Central Térmica Teruel	WBB	LNB - Air staging - WFGD - ESP	Power	3000	Coal 100	8004	69	1979
443-1V	ES	Alcúdia (Mallorca)	DBB	LNB - Air/Fuel staging - FGR - SDA - BF	Power	805	Coal 97	8680	71	NA
443-2V	ES	Alcúdia (Mallorca)	DBB	LNB - Air/Fuel staging - FGR - SDA - BF	Power	755	Coal 98	7528	72	NA
444V	ES	Central Térmica As Pontes (La Coruña)	DBB	Low air excess - LNB - Air/Fuel staging - FGR - Low-S coal - ESP	Power	3800	Coal 100	8271	60	1976
445V	ES	C.C. Colón, Huelva	CCGT	DLN	Power	719	NG 100	2916	71	2006
446V	ES	GRANADILLA DE ABONA (SANTA CRUZ DE TENERIFE)	CCGT	Water injection	Power	486	Gas oil 100	8223	72	2006
447V	ES	Biomasa Sangüesa, (Navarra)	GB	BF	Power	79	Herb 99.7 - NG 0.3	7811	112	2002
449V	ES	Solvay Química, Torrelavega	DBB	DBB - Low-S coal - ESP	Chemical industry	376	Coal 94 - NG 5 - HFO 1	8760	56	1987
453V	SE	Jämtkraft AB - Minnesgärdet, Östersund	GB	AS - FGR - FG condenser - ESP	District heating	28	WB 99	1700	59	1981
454V	SE	Minnesgärdet P1-3	Liquid B	LNB - ESP - FG condenser - fuel choice	District heating	84	HFO 100	270	28	1979
455V	SE	Jämtkraft AB - Lugnvik	CFB	AS - FGR - SNCR with SCR FG condenser - ESP - CHP	Power and district heating	138	WB 50 - Bark 19 - Forest R 17 - Solid Waste 8 - Peat 6	6918	82	2000
456V	SE	Jämtkraft AB - Lugnvik, Östersund	CFB	FGR - FG condenser - ESP - CHP	District heating	28	WB 50 - Bark 20 - Forest R 20 - Peat 10	2800	65	1984
457V	SE	Jämtkraft AB - Lugnvik, Östersund	BFB	FGR - FG condenser - ESP - CHP	District heating	28	WB 50 - Bark 20 - Forest R 20 - Peat 10	3200	69	1984
458NV	SE	Eskilstuna Energy o Miljö - Vattumannen, Eskilstuna	BFB	LNB - AS - FGR - SNCR	Power and district heating	112	WB Chips 100	7763	84	2000
460V	SE	Jönköping Energi AB - Munksjö, Jönköping	WBB	LNB - AS - ESP	Power, district heating, pulp and paper	68	Sawdust 99.6	7062	55	1963

462V	SE	Tekniska verken i Linköping AB - Kraftvärmeverket, Linköping	GB	SNCR - SDA - BF	Power and district heating	74	Coal 56 - Waste 37 - WBB 7	3955	98	1964
464V	SE	Tekniska verken i Linköping AB - Kraftvärmeverket, Linköping	Boiler	SNCR - WFGD - Cyclone - ESP	Power and district heating	74	Solid waste 93 - Bark 7	6848	98	NA
466NV	SE	Hedensbyverket H2	CFB	FGR - SNCR	Power and district heating	98	WB 83 - Peat 17 - HFO 0.1	8120	70	1997
467NV	SE	Säbyverket Boiler 12	DBB	LNB	District heating	33	WB Pellets 90	NA	NA	1978
468V	SE	Karlshamnsverket Block 3	Liquid B	WFGD - ESP - Steam injection - FGR - SCR	Power	781	HFO 100	631	74	1972
469V	SE	SCA Östrand Steam Boiler 1	BFB	ESP	Pulp and paper	180	Bark 84.5 - HFO 15.5	8616	44	2009
470V	SE	Perstorp Specialty Chemicals AB - Ångcentralen, P6, Perstorp	CFB	FGR - SNCR - BF - ACI - Sorbent injection - FG condenser	Chemical industry	50	Wood 49 - Solid waste 25 - Peat 21	7270	82	1991
472V	SE	Perstorp Specialty Chemicals AB - Ångcentralen, P8, Perstorp	Liquid B	WESP - Wet scrubber - FG condenser	Chemical industry	17	NA	8064	84	2007
473V	SE	Kalmar Energi - Moskogen, Kalmar	BFB	FGR - AS - SNCR - FG condenser - ESP	Power and district heating	99	WB 99.85	5910	84	2009
476V	SE	E.On Värme Sverige AB - Händelö	CFB	ESP - SNCR - Sorbent injection - FG condenser	Power and district heating	146	Forest R 80 - Solid waste 20	5755	83	2009
477V	SE	Borealis AB - Steam boiler unit inside Ethylene plant, Stenungsund	GasB	LNB - Air staging	Chemical industry	161	Process gases	8760	46	1969
478-1	TU	İSKENDERUN ENERJİ ÜRETİM VE TİC. A.Ş. - Sugözü Power Plant - Unit 10, Adana	DBB	LNB - Air staging - Low-S coal - WFGD - ESP	Power	1558	Coal 100	8170	92	2003
478-2	TU	İSKENDERUN ENERJİ ÜRETİM VE TİC. A.Ş. - Sugözü Power Plant - Unit 20, Adana	DBB	LNB - Air staging - Low-S coal - WFGD - ESP	Power	1558	Coal 100	7010	91	2003

479V	UK	Drax Power Station - Yorkshire	DBB	LNB - Air staging - WFGD - ESP	Power	1600	Coal 90 - Wood 7 - Coke 3	8610	NA	1975
480V	UK	Keadby, Scunthorpe	CCGT	DLN (to be retrofitted in 2012)	Power	1489	NG 100	7646	83	1995
481V	UK	SSE Generation Ltd - Peterhead	CCGT	DLN	Power	2031	NG 100	8379	70	2000
482V	UK	Medway	CCGT	DLN - To be retrofitted in 2012	Power	1465	NG 100	7340	74	1995
483	UK	March wood, Southampton	CCGT	DLN	Power	NA	NG 100	7919	NA	2009
486	UK	Keadby Generation Ltd - Ferrybridge C, Pontefract	DBB	LNB - Air staging - WFGD - ESP with SO ₃ injection	Chemical industry	1360	Coal 100	4000	100	1967
487-1V	UK	Keadby Generation Ltd - Fiddlers Ferry, Warrington	WBB	LNB - Air staging - Ultra-low-sulphur coal - ESP with SO ₃ injection	Chemical industry	5269	Coal 98 - Fruit 2	NA	NA	1971
487-2V	UK	Keadby Generation Ltd - Fiddlers Ferry, Warrington	WBB	LNB - Air staging - WFGD - Planned improvements for NO _x reduction - ESP with SO ₃ injection	Chemical industry	5269	Coal 98 - Fruit 2	NA	NA	1972
487-3V	UK	Keadby Generation Ltd - Fiddlers Ferry, Warrington	WBB	LNB - Air staging - WFGD - ESP with SO ₃ injection	Chemical industry	5269	Coal 98 - Fruit 2	NA	NA	1972
487-4V	UK	Keadby Generation Ltd - Fiddlers Ferry, Warrington	WBB	LNB - Air staging - WFGD - ESP with SO ₃ injection	Chemical industry	5269	Coal 98 - Fruit 2	NA	NA	1973
488V	UK	Keadby Generation Ltd - Weston Point, Runcorn	CCGT	Steam injection	NA	231	NG 100	7895	60	1998
489-1V	UK	Slough Heat and Power Limited FBB1	CFB	AS - Activated carbon injection - Sorbent injection - BF	CHP	92	WB 56 - Forest R 39 - Coal 4 - NG 1	4648	90	1972
489-2V	UK	Slough Heat and Power Limited FBB2	CFB	AS - Activated carbon injection - Sorbent injection - BF	CHP	92	WB 56 - Forest R 39 - Coal 4 - NG 1	5313	89	1993
489-3V	UK	Slough Heat and Power - Slough Heat & Power, Slough	GB	Air staging - SDA - BF - Activated carbon	CHP	69	Solid waste 55 - Wood 38 - NG 6	6803	64	2002
490V	UK	SSEPG Operations Ltd - Burghfield	OCGT	Water injection	Power	142	NG 100	332	89	1997

491V	UK	SSEPG Operations Ltd, Chickerall	OCGT	Water injection	Power	142	NG 100	284	102	1997
493V	UK	RWE npower - Aberthaw Power Station	DBB	Fuel staging - Seawater FGD - ESP	Power	4116	Coal 97 - HFO 1.5 - WBB 1.5	4038	89	1971
494V	UK	RWE npower - Staythorpe Power Station	CCGT	DLN alone recently built	Power	740	NG 100	8188	91	2010
495	UK	Rolls-Royce Energy - Derby CHP	CCGT	DLN alone - Application of efficiency correction	NA	120	NG 100	3000	NA	1997
496VC	UK	EDF Energy - West Burton A, Nottinghamshire	DBB	LNB - Air staging - WFGD	Power	1393	Coal 97 - HFO 2 - FB 0.4	2406	89	1968
497V	UK	Sizewell B 2035 (2040) Essential Diesel Generators	Engine	Fuel choice	Power	13	Gas oil 100	64	53	NA
498V	UK	Sizewell B 2035 (2040) Auxiliary boilers	Liquid B	Air staging - Low-S fuel	Heat and Power	22	Gas oil 100	1187	35	1995
499V	UK	EDF Energy - Heysham 1 power station (Gas turbines), Lancashire, UK	OCGT	NA	Power	70	Gas oil 100	48	95	1978
500V	UK	National Grid Gas plc - Avonbridge East A	OCGT	DLN	Mechanical drive	75	NG 100	NA	NA	2004
501V	UK	National Grid Gas plc - Hatton A	OCGT	Standard burners	Mechanical drive	65	NG 100	870	79	1989
502V	UK	E.ON - Killingholme	CCGT	DLN	Power	445	NG 100	3805	96	1992
503V	UK	E.ON - Enfield	CCGT	Two-stage DLN	Power	687	NG 100	6255	95	1999
504	UK	E.ON - Citigen, London	DF Engine	SCR	Power and district heating	39	NG 73 - Gas oil 27	2008	63	1995
505V	UK	E.ON - Steven's Croft, Lockerbie	BFB	AS - FGR - DSI Activated carbon - BF	Power	139	WB Chips 100	5892	88	2007
506V	UK	Centrica - Langage Energy Centre, Plymouth	CCGT	DLN	Power	750	NG 100	5125	98	2009
507V	UK	Centrica - South Humber Bank power station, Stallingborough	CCGT	DLN	Power	458	NG 100	7358	100	2001

508V	UK	Centrica - Killingholme Power Station	CCGT	DLN	Power	448	NG 100	1642	94	1993
509	UK	BASF Performance Products plc - On site Boilerhouse, Paisley	GasB	LNB - Plant to be derated under 50 MW _{th}	Chemical industry	76	NG 100	NA	NA	NA
513V	UK	Polimerieuropa - Grangemouth	GasB	LNB - Air staging - Switch from HFO to gas oil as secondary fuel	Chemical industry	53	NG 100	8256	31	1996
517V	UK	Dalkia Plc - Alderley Park Energy Centre, Cheshire	GasB	LNB - FGR	NA	74	NG 100	8760	14	2004
518V	UK	British Sugar - Wissington Sugar Factory, Norfolk	CCGT	DLN (GT) + LNB (SF)	Food & Drink	207	NG 82 - DFO 18	8423	81	1998
519V	FR	TOTAL - Boiler 202 - Gouffreville l'Orcher	Boiler	LNB - Air and fuel staging	Chemical industry	135	Gaseous process fuel 48.3 - Liquid process fuel 6.8 - HFO 44.3	8574	58	1972
520V	FR	SOLVAY - GNF - Tavaux	WBB	LNB - Air staging - ESP with SO ₃ injection	Chemical industry	134	Coal 100	8088	80	1984
521V	FR	SOLVAY - GNB - Tavaux	GasB	Air staging - FGR - LNB	Chemical industry	84	NG 64 - H ₂ 36	5586	54	1978
527V	NL	DOW - K5 - Dow Terneuzen	Boiler	LNB - Air staging	Chemical industry	285	Process gases 100	1622	NA	1976
529	BE	Borealis Polymers NV - PPUT - Beringen	GasB	LNB - Air staging - FGR	Chemical industry	108	Process gases 66 - NG 33	6006	13	1977
535-1	BE	BASF-Antwerpen - Utility plant	GasB	LNB - Air and fuel staging	Chemical industry	165	Liquid process fuel (30.3+3.6+0.5) - Gaseous fuel 6.6 - NG 59	7678	44	1966
535-2	BE	BASF-Antwerpen - Utility plant	GasB	LNB - Air and fuel staging - Fuel choice	Chemical industry	208	Liquid process fuel 42 - NG 58	5655	14	1966
535-3	BE	BASF-Antwerpen - Utility plant	GasB	Each fuel has its own burner - LNB - Air and fuel staging	Chemical industry	161	NG 100	2910	9	1966
536	AT	Wien Energie Bundesforste Biomasse Kraftwerk (WEBBK) / Wien-Simmering - Vienna	CFB	AS - FGR - SNCR with SCR - BF	NA	66	WB Chips 99.6	7280	99	2006

539V	FI	Keljonlahti power plant - Jyväskylä	CFB	Air preheating - AS - SNCR FG condenser - ESP - CHP	Power and district heating	485	Peat 70 - WB 30	6857	76	2010
543-1V	UK	Jersey Electricity plc - La Collette Power Station, Jersey	Engine	NA	Power	28	HFO 24 - Gas oil 76	321	79	1992
543-2V	UK	Jersey Electricity plc - La Collette Power Station, Jersey	Engine	NA	Power	25	HFO 40 - Gas oil 60	277	115	1992
547V	IT	Enel Produzione - Federico II - Brindisi	DBB	Air/Fuel staging - LNB - SCR - WFGD - Supercritical steam	Power	1700	Coal 98	7285	72	1993
586V	IT	Enel Produzione - Portoferraio	OCGT	NA	Power	72	Gas oil 100	149	86	1974
593-1V	CZ	ArcelorMittal Ostrava	WBB	Normal separate burners (COG jet burners - Pulverised coal burners) - ESP	Iron & Steel	199	BF 56 - Coal 34 - COG 10	NA	NA	1995
593-2V	CZ	ArcelorMittal Ostrava	GasB	Jet burners - Gas preheater	Iron & Steel	71	BOF 75 - COG 25	NA	NA	1955
593-3V	CZ	ArcelorMittal Ostrava	DBB	LNB separate burners (Coal/COG-BFG) - LNB (coal) - Semi-roof turbulent jet burners for COG/BFG - ESP - Planned additional DeNO _x /DeSO _x	Iron & Steel	610	Coal 83 - BF 12 - COG 5	NA	NA	1960
593-4VC	CZ	ArcelorMittal Ostrava	DBB	LNB separate burners (Coal/COG-BFG) - LNB (coal) - Semi-roof turbulent jet burners for COG/BFG - ESP - Planned additional DeNO _x /DeSO _x	Iron & Steel	90	Coal 74 - BF 18 - COG 8	NA	NA	1953
593-5V	CZ	ArcelorMittal Ostrava	NA	Overall site 593	Iron & Steel	1067	Coal 65 - BFG 26 - COG 9	8750	64	NA
595V	FI	Ruukki Metals Oy - Raahe K3 - Raahe	GasB	Normal separate burners (BF/COG-oil/oil) - Liquid fuel (HFO 0.8 %)	Iron & Steel	288	BF 75 - HFO 12 - COG 6 - Liquid 7	8431	87	1975
596V	FI	Ruukki Metals Oy - Raahe K4 - Raahe	GasB	LNB - Air staging - Liquid fuel (HFO 0.8 % S)	Iron & Steel	254	BF 82 - HFO 11 - COG 7	7886	106	1990

597V	FR	ArcelorMittal Fos - Centrale Soufflante	GasB	Include 4 different boilers (3 from 1972 and one from 1996) / Planned SNCR in one of them in 2013	NA	345	BFG 49 - BOG 6 - COG 33 - Liquid fuel 12	8760	NA	NA
601-1	DE	Salzgitter Flachstahl GmbH - Kraftwerk SZ-Hallendorf - Salzgitter	GasB	FGR - LNB Separate burners (COG-Liquids/ BFG-NG)	Iron & Steel	1220	BF 54 - COG 32 - BOF 7 - NG 7	8757	50	1988
601-2	DE	Salzgitter Flachstahl GmbH - Kraftwerk SZ-Hallendorf - Salzgitter	GasB	FGR - LNB Separate burners (for COG/Liquids and BFG/NG)	Iron & Steel	1220	BF 54 - COG 32 - BOF 7 - NG 7	8757	50	1991
601-3	DE	Salzgitter Flachstahl GmbH - Kraftwerk SZ-Hallendorf - Salzgitter	GasB	FGR - LNB Separate burners (for COG/Liquids and BFG/NG)	Iron & Steel	1220	BF 54 - COG 32 - BOF 7 - NG 7	8757	50	1992
601-4	DE	Salzgitter Flachstahl GmbH - Kraftwerk SZ-Hallendorf - Salzgitter	GasB	LNB - FGR	Iron & Steel	1220	BF 54 - COG 32 - NG 7 - BOF 7	8757	50	2010
601-5	DE	Salzgitter Flachstahl GmbH - Kraftwerk SZ-Hallendorf - Salzgitter	GasB	LNB - FGR	Iron & Steel	1220	BF 54 - COG 32 - NG 7 - BOF 7	8757	50	2010
602	DE	ThyssenKrupp Steel AG - Kraftwerk Duisburg-Ruhrort, Block 2 - Duisburg	GasB	Normal separate burners (pure BFG / pure COG) (Fuel staging)	Iron & Steel	179	BF 85 - COG 15	5213	80	1958
603	DE	ThyssenKrupp Steel AG - Kraftwerk Duisburg-Ruhrort, Block 3 - Duisburg	GasB	Normal separate burners (pure BFG / pure COG) (Fuel staging)	Iron & Steel	722	BF 82 - COG 18	7916	99	1963
605	DE	ThyssenKrupp Steel AG - Kraftwerk Duisburg-Hamborn, Block 3 - Duisburg	GasB	LNB Separate burners (pure BFG / combined COG/NG LNB) - Air/fuel staging	Iron & Steel	178	BF 73 - COG 27	8078	NA	1958
606	DE	ThyssenKrupp Steel AG - Kraftwerk Duisburg-Hamborn, Block 4 - Duisburg	GasB	LNB Separate burners (pure BFG / combined COG/NG LNB) - Air/fuel staging	Iron & Steel	312	BF 73 - COG 27	8107	76	1976
607	DE	DK Recycling und Roheisen GmbH - Kraftwerk - Duisburg	GasB	Normal separate burners (BF/NG)	Iron & Steel	90	BF 92 - NG 8	7173	62	1981
611V	NL	Tata Steel Mainland Europe - Ketel 15, Ijmuiden	GasB	Combined burners - FGR	Iron & Steel	110	BF 61 - COG 38 - NG 1	8378	58	1965
612V	NL	Tata Steel Mainland Europe - Ketel 16, Ijmuiden	GasB	Combined burners	Iron & Steel	110	BF 65 - COG 34 - NG 1	6373	61	1970

613V	NL	Tata Steel Mainland Europe - Ketel 23, Ijmuiden	GasB	Combined burners - FGR	Iron & Steel	110	BF 86 - NG 9 - COG 5	7104	54	1973
614V	NL	Tata Steel Mainland Europe - Ketel 24, Ijmuiden	GasB	Combined burners - FGR	Iron & Steel	110	BF 68 - COG 28 - NG 4	4513	54	1985
615V	NL	Tata Steel Mainland Europe - Ketel 41, Ijmuiden	GasB	Normal separate burners (NG/BFG)	Iron & Steel	56	BF 90 - NG 10	7580	58	1984
616V	NL	Tata Steel Mainland Europe - STEG11, Ijmuiden	CCGT	CCGT - GT burns NG - Steam injection - Supplementary firing burns	Iron & Steel	110	NG 63 - BF 37	7742	64	1989
617V	PL	ArcelorMittal - Krakow	DBB	Normal separate burners (BF-COG/coal) Powdered-fuel burner and gas burners	Iron & Steel	552	Coal 58 - BF 23 - COG 19	8500	36	1954
618V	PL	ArcelorMittal - Krakow	DBB	Normal separate burners (BF-COG/Coal) - Ongoing modernisation with 8 LNB for BF + Automation for the other	Iron & Steel	294	Coal 58 - BF 23 - COG 19	8500	35	1965
619-1V	SE	SSAB EMEA - P1 - OK2, Oxelösund	GasB	Standard burners - Low-S liquid fuel (0.4 % HFO)	Iron & Steel	25	BF 79 - COG 20 - HFO 1	8152	54	1957
619-2V	SE	SSAB EMEA - P2 - OK2, Oxelösund	GasB	LNB separate burners - Low-S liquid fuel (0.4 % HFO)	Iron & Steel	25	BF 78 - COG 20 - HFO 2	6725	53	1957
620V	SE	SSAB EMEA - P4, Oxelösund	GasB	LNB Separate burners (BF - COG)	Iron & Steel	215	Mixture mainly BF-COG	7872	47	1971
621V	SE	Lulekraft AB, LKV, Luleå	GasB	Low-S liquid fuel (0.4 %) - LNB Separate burners (COG-gas oil/BF/gas oil back-up)	Iron & Steel	350	BF 90 - Gas oil 9 - COG 1	7315	81	1982
623V	UK	Tata Steel Europe - MargamA3, Port Talbot	GasB	LNB Separate burners (NG/Mixed gas (BF+BOF?))	Iron & Steel	99	BF 88 - NG 9 - BOF 3	8470	NA	NA
624V	UK	Tata Steel Europe - MargamA5, Port Talbot	GasB	FGR - LNB separate burners (NG/COG/Mixed gas?)	Iron & Steel	50	BF 80 - NG 9 - COG 8 - BOF 3	8668	NA	NA
625V	UK	Tata Steel Europe - MargamB, Port Talbot	GasB	FGR - LNB separate burners (NG/COG/Mixed gas?)	Iron & Steel	80	BF 88 - COG 8 - BOF 2 - NG 2	8620	NA	NA
626V	UK	Tata Steel Europe - MargamC, Port Talbot	GasB	FGR - LNB Separate burners (NG/COG/Mixed gas?)	Iron & Steel	268	BF 68 - COG 13 - NG 13 - BOF 6	8760	NA	NA

627V	UK	Tata Steel Europe - Service boilers, Port Talbot	GasB	LNB separate burners (NG/BF/COG)	Iron & Steel	114	BF 56 - COG 42 - NG 2	8760	NA	NA
628-1V	UK	Tata Steel Europe - Central Power Station, Scunthorpe	GasB	NEI combined burners BFG/COG	Iron & Steel	108	BF 60 - COG 37 - HFO 3	7769	83	1976
628-2V	UK	Tata Steel Europe - Central Power Station, Scunthorpe	GasB	NEI combined burners BFG/COG burners - Low-S liquid fuel (0.17 %)	Iron & Steel	108	BF 63 - COG 34 - HFO 3	8022	83	1976
628-3V	UK	Tata Steel Europe - Central Power Station, Scunthorpe	GasB	Peabody-type M22 burners	Iron & Steel	49	BF 88 - COG 12	4974	64	1960
629-1V	UK	Tata Steel Europe - Turbo Blower House A, Scunthorpe	GasB	Typhoon-type BFG burner - Low-S liquid fuel (0.17 %)	Iron & Steel	39	BF 96 - COG 3 - HFO 1	8124	70	1953
629-2V	UK	Tata Steel Europe - Turbo Blower House A, Scunthorpe	GasB	Typhoon-type BFG burner - Low-S liquid fuel (0.17 %)	Iron & Steel	39	BF 96 - COG 3 - Gas oil 1	7619	72	1953
629-3V	UK	Tata Steel Europe - Turbo Blower House A, Scunthorpe	GasB	Typhoon-type BFG burner - Low-S liquid fuel (0.17 %)	Iron & Steel	39	BF 96 - COG 2 - HFO 2	6870	77	1953
629-4V	UK	Tata Steel Europe - Turbo Blower House A, Scunthorpe	GasB	Typhoon-type BFG burner - Low-S liquid fuel (0.17 %)	Iron & Steel	39	BF 96 - COG 2 - HFO 2	7039	73	1953
630-1V	UK	Tata Steel Europe - Turbo Blower House B, Scunthorpe	GasB	Typhoon-type BFG burner - Low-S liquid fuel (0.17 %)	Iron & Steel	54	BF 94 - COG 3 - Gas oil 3	3851	81	1953
630-2V	UK	Tata Steel Europe - Turbo Blower House B, Scunthorpe	GasB	Typhoon-type BFG burner - Low-S liquid fuel (0.17 %)	Iron & Steel	54	BF 97 - COG 2 - HFO 1	7337	87	1961
632	AT	GuD Kraftwerk Timelkam	CCGT	DLN - SCR - Only range available - Air mass flow reduction for low loads	Power	705	NG 100	4600	90	2008
654V	BE	T-Power n.v. - Tessenderlo	CCGT	DLN	Power	750	NG 100	1680	100	2011
655V	DE	Mark-E Aktiengesellschaft - Biomasseverstromungsanlage Hagen-Kabel - Hagen	GB	LNB - AS - FGR - SNCR - DSI activated carbon - BF	Power	86	WB 99.2 (including waste wood)	8433	74	2004
656V	AT	WIEN Energie GmbH - Donaustadt 3 - Vienna	CCGT	DLN - SCR	Power and district heating	686	NG 100	5831	90	2001

657	EE	Tallina Kute - Kadaka BH - Tallinn	GasB	LNB - Air/Fuel staging - FGR	District heating	316	NG 100	8150	14	1997
658	EE	Tallina Kute -Mustamae BH - Tallinn	GasB	Combination NO _x PM (Air/Fuel staging and 16 LNB in 1/4 boilers)	District heating	446	NG 100	NA	NA	NA
659	EE	Tallina Kute - Ulemiste BH - Tallinn	GasB	Standard burners	District heating	255	NG 100	2112	10	1999
660	EE	Fortum Eesti AS - Parnu Niidu CHP - Parnu	BFB	LNB - FGR - SNCR - DSI - BF	NA	81	WB Chips 83 - Peat 16 - NG 1	7920	97	NA
661	EE	Fortum Eesti AS - Parnu Suur Joe boilerhouse - Parnu	NA	NA	NA	70	Peat 10 - NG 50 - HFO 1	6768	19	NA
662V	AT	FHKW Mellach	WBB	Air/Fuel staging - LNB - SCR - WFGD - BF	Power and district heating	543	Coal 98.8 - NG 1 - Waste 0.2	6427	95	1986
664V	FR	Cristal Union - Boiler FML13 - Erstein	GasB	NA	NA	51	NG 100	3216	74	
665	DE	GKW Smurfit Kappa Zülpich Papier	NA	Water injection	Pulp and paper	38	NG 19	8426	61	1996
666	SE	ÅC2 Obbola	DBB - other	SNCR - Air staging - ESP	Pulp and paper	110	Bark 95	7987	43	1975
667	SE	Smurfit Kappa Kraftliner Piteå	BFB	SNCR - Air staging - Flue-gas recirculation - BF	Pulp and paper	165	Bark 67 - Wood chips 31 - Solid waste 2	8500	44	2007
668	SE	Södra Cell Mönsterås	BFB	SNCR - Air staging - Flue-gas recirculation - ESP	Pulp and paper	96	Bark 95.5	8066	75	1979
669	SE	Södra Cell Mörrum	BFB	Air staging - Flue-gas recirculation - ESP	Pulp and paper	111	Bark 95	6400	57	2002
670	SE	Stora Enso Fors	CFB	SNCR - Air staging - Flue-gas recirculation - ESP	Pulp and paper	61	Forest R 89 - Bark 8 - Pellets 3	8101	96	1985
671	SE	Stora Enso Hylte AB - 2	BFB	SNCR - Air staging - Flue-gas recirculation - ESP - BF - Scrubber	Pulp and paper	80	Solid waste 100	7626	64	1972
672	SE	Stora Enso Hylte AB - 4	CFB	SNCR - Air staging - Flue-gas recirculation - ESP - Scrubber	Pulp and paper	65	SW 15 - Solid waste 65 - Bark 20	7627	65	1973

673	SE	Nymölla Mill	BFB	SNCR - Air staging - Flue-gas recirculation - ESP - scrubber	Pulp and paper	115	Bark 58 - HFO 17 - Petroleum gas 8 - Solid fuel (sludge) 17	8699	49	NA
674	SE	Stora Enso Skoghall AB Boiler 11	BFB	SNCR with SCR - Air staging - Flue-gas recirculation - ESP	Pulp and paper	179	Forest R 66 - Bark 18 - Sawdust 9 - Other (sludge) 3.5 - Other (fibre from WWTP) 3.5	7847	54	1977
675	ES	Zicuñaga	Gas turbine	DLN - Water injection	Pulp and paper	NA	NG	NA	NA	2008
676	ES	Ence Navia	BFB	NA	Pulp and paper	75	Bark	NA	NA	NA
677	FI	Metsä Group Simpele	BFB	Air staging - Flue-gas recirculation - ESP	Pulp and paper	127	WB 62 - Peat 38	8395	51	1976
678	FI	Äänevoima Oy	BFB	Air staging - Flue-gas recirculation	Pulp and paper	173	Peat 14 - WB 82.5 - Solid Waste 3.5	8313	58	2002
679	FI	Stora Enso Imatra	BFB	Air staging - Flue-gas recirculation	Pulp and paper	267	Bark 100	NA	NA	1992
680	FI	UPM Jämsänkoski	Boiler	Air staging - Flue-gas recirculation	Pulp and paper	205	WB 14.1 - Forest R 60.4 - Peat 19.1 - WB 6.3 - HFO 0.1	8453	52	2002
681	FI	Äänevoima Oy oil	Boiler	Air staging - LNB - multicyclone	Pulp and paper	93	HFO	584	23	1996
682	PT	Setubal	BFB	Air staging - Flue-gas recirculation - ESP	Pulp and paper	134	Bark 98.5	6932	52	1978
683	FR	CTBR Tranche 1 - Saint André - La Réunion	GB	Air staging alone - ESP	NA	101	Coal 100	7270	110	1992
684	FR	CTBR Tranche 1 - Saint André - La Réunion	GB	Air staging - ESP	NA	116	Herb 64 - Coal 36	8712	101	1992
685	FR	CTG A Tranche 1 - St Louis - La Réunion	GB	Air staging alone - ESP	NA	103	Coal 100	7563	107	1995
686	FR	CTG A Tranche 1 - St Louis - La Réunion	GB	Air staging - ESP	NA	128	Herb 68 - Coal 32	8569	91	1995
687	FR	CTM Tranche 1 - Le Moule - Guadeloupe	GB	Air staging alone - ESP	NA	91	Coal 100	7548	104	1998

688	FR	CTM Tranche 1 - Le Moule - Guadeloupe	GB	Air staging alone - ESP	NA	124	Coal 53.5 - Herb 46.5	8047	93	1998
689	FR	CTBR 2 - Cambuston - La Réunion	Boiler	Air/fuel staging - ESP	Power	144	Coal 100	7705	108	2004
690	FR	CTG B St Louis - La Réunion	Boiler	LNB - Air/fuel staging - SNCR - ESP	NA	163	Coal 100	7950	97	2006
691	FR	PEI-Port-Est La Réunion	Engine	SCR	Power	516	HFO 99.9	5500	70	2012
692	FR	EDF SEI Lucciana	Gas turbine	Water injection	NA	140	Liquid fuel - Gas oil/light fuel oil - Diesel	2159	14	2008
693	PL	Siersza Power Plant	CFB	CFB - ESP	NA	674	Coal 86 - Wood 14	7800	89	2001
1000V	Anonymous	Anonymous	DBB	LNB - Air staging - SDA - ESP	Power and district heating	265	Coal 97	3283	99	1977
1001V	Anonymous	Anonymous	CFB	Boiler sorbent injection - ESP	District heating	80	Coal 100	1960	75	1986
1002V	Anonymous	Anonymous	BFB	Air staging - FGR - ESP - WFGD + FG condenser	Power and district heating	58	Wood 78 - Peat 22	7430	80	2009
1003V	Anonymous	Anonymous	BFB	Air staging - FGR - ESP - CHP	Pulp and paper	295	Bark 53 - Peat 16 - Forest R 24 - Wood chips 6	7106	50	2002
1004V	Anonymous	Anonymous	CFB	Air staging - ESP	Power and district heating	325	Peat 86 - Forest R 10 - Wood 3 - Seeds 1	7564	97	1990
1005V	Anonymous	Anonymous	DBB	LNB - Air staging - FGR - SCR - WFGD - ESP - Supercritical steam - Planned new LNBs in 2013	Power	1400	Coal 100	6900	87	1994

1006V	Anonymous	Anonymous	CCGT	DLN - District heating	Power and district heating	498	NG 100	6040	94	2009
1007V	Anonymous	Anonymous	CCGT	Steam injection - District heating	Power and district heating	167	NG 100	5502	75	1989
1008V	Anonymous	Anonymous	GasB	LNB	District heating	45	NG 100	1481	59	2003
1009V	Anonymous	Anonymous	Liquid B	LNB - Multicyclones	District heating	45	HFO 100	1481	59	2003
1010V	Anonymous	Anonymous	GasB	NA	Chemical industry	873	Tail oil 21 - NG 58 - Ch. Process gas 16 - HFO 5	8760	30	1972
1011V	Anonymous	Anonymous	GasB	NA	Chemical industry	434	Tail oil 28 - NG 44 - Ch. Process gas 21 - HFO 7	8760	30	1972
1012V	Anonymous	Anonymous	BFB	Fuel and air staging - FGR - Scrubber - ESP	Pulp and paper	120	Peat 60 - Bark 18 - Coal 12 - Wood chips 7 - HFO 3	8344	77	1984
1013V	Anonymous	Anonymous	CCGT	DLN - NG preheating	Power and district heating	714	NG 100	7913	85	2005
1014R	Anonymous	Anonymous	GB	NA	District heating	166	Coal 100	5100	34	NA
1015R	Anonymous	Anonymous	GB	FGR - BF	NA	20	Coal 100	NA	NA	1986

List of acronyms used for combustion processes:

BFB: Bubbling fluidised bed; CCGT: Combined-cycle gas turbine; CFB: Circulating fluidised bed; DBB: Dry-bottom boiler; DF Engine: Dual fuel engine; GB: Grate-fired boiler; GasB: Gas-fired boiler; HRSG: Heat recovery steam generator; LiquidB: Liquid-fuel-fired boiler; OCGT: Open-cycle gas turbine; SG Engine: Spark-ignited gas engine; WBB: Wet-bottom boiler.

List of acronyms used for techniques:

AS: Air staging; BF: Bag filter; CHP: Combined heat & power; DLN: Dry low-NO_x burners; DSI: Duct sorbent injection; ESP: Electrostatic precipitator; FG condenser: Flue-gas condenser; FGR: Flue-gas recirculation; LNB: Low-NO_x burner; PM: Primary measures; SCR: Selective catalytic reduction; SNCR: Selective non-catalytic reduction; WESP: Wet ESP; WFGD: Wet flue-gas desulphurisation.

List of acronyms used for fuels:

BF: Blast furnace gas; BOF: Basic oxygen furnace gas; Ch: Chemical; COG: Coke oven gas; DFO: Distillate fuel oil; FB: Fruit biomass (stones/shells/kernels); Forest R: Forest residues; HFO: Heavy fuel oil; NG: Natural gas; WB: Woody biomass; WBB: Woody biomass woodchip; WWTP: Waste water treatment plant.

NA: Not available.

13.2 Annex II - List of waste co-incinerated

WASTE STREAMS - Based on the European Waste List (Commission Decision 2000/532/EC)	
Key waste chapters (not exhaustive)	Key waste codes (not exhaustive, without wood waste)
02 Waste from agricultural, horticultural, hunting, fishing and aquacultural primary production, food preparation and processing	020102/020202 - Animal tissue waste 02106 - Animal faeces, urine and manure (including spoiled straw), effluent, collected separately and treated off site 02107 - Waste from forestry exploitation 020203/020304 - Materials unsuitable for consumption or processing 0203 - Wastes from fruit, vegetables, cereals, edible oils, cocoa, coffee and tobacco preparation and processing; conserve production
03 Wastes from wood processing and the production of paper, cardboard, pulp, panels, and furniture	030101/030301 - Waste bark and cork 030103 - Shaving, cuttings, spoiled timber, particleboard, veneer 030105 - Sawdust, shavings, cuttings, wood, particleboard and veneer other than those mentioned in 030103 030305 - De-inking sludge from recycling 030306 - Fibre and paper sludge 030307 - Rejects from paper recycling 030310 - Fibre rejects, fibre-, filler- and coating-sludges from mechanical separation Others (not included in the European Waste List): • Sludge from waste water treatment in the pulp and paper industry
10 Inorganic wastes from thermal processes	100102 - Coal fly ash Others (not included in the European Waste List): • FGD sludge NB: The permission may be temporary while looking for alternative disposal.
13 Oil wastes (except edible oils, 05 and 12)	1302 - Waste engine, gear and lubricating oils 1305 - Oil/water separator contents (NB: oil from oil separator) 130701 - Waste of fuel oil and diesel Others (not included in the European Waste List): • Gas oil
15 Waste packaging, absorbents, wiping cloths, filter materials and protective clothing not otherwise specified	150101- Paper packaging 150102- Plastic packaging 150103- Wooden packaging 150106 - Mixed packaging

17 Construction and demolition wastes	170201 - Wood 170203 - Plastic 170303* - Tar and tar products 170904 - Other mixed construction and demolition wastes Others (not included in the European Waste List): • Mixed glass, plastic, wood
19 Wastes from waste treatment facilities, off-site waste water treatment plants and the water industry	190204* - Premixed wastes 190207 - Oil and concentrate from separation 190210 - Other combustible waste 190501 - Non-composted fraction 190503 - Off-specification compost; Sludge from the treatment of industrial waste water; Urban waste water sludge 1909 - Wastes from the preparation of drinking water or water for industrial use 191210 - Combustible waste (refuse-derived fuel) 191211* - Other wastes (including mixtures of materials) from mechanical treatment of waste containing dangerous substances 191212 - Other wastes (including mixtures of materials) from mechanical treatment of wastes other than those mentioned in 191211* Others (not included in the European Waste List): • Plastic and rubber • Waste-derived fuels • Other (mixed) waste from mechanical treatment of waste
WASTE THAT CEASES TO BE WASTE (examples based on national practices) Please note that these materials are not considered waste but fuel (<i>see Article 6 'end-of-waste' of Directive 98/2008/EC on waste</i>) Situations vary across the EU and the different streams can be either in compliance with the definition of biomass for LCP, waste streams or end-of-waste/waste that ceases to be waste.	
• Process fuel oil from waste lubricating oil	
• Natural non-hazardous agricultural or forestry material used for the production of energy but which has not been excluded from (Article 2 of) the revised Waste Framework Directive but which has subsequently passed the end-of-waste test. This potentially includes biomass residues from the olive, sunflower, grape, peanut and palm production industries.	
• Meat and bone (animal tissue)	
Sources: [85, Eurelectric 2012] [283, Sweden 2013] [284, CEPI 2013] NB: For hazardous waste: <ul style="list-style-type: none"> • Waste and residues from industrial process are occasionally co-incinerated in public power and heat plants (e.g.: waste from the textile industry [0402]; waste from phosphor production [0609]; waste from the chemical industry). Such industry-specific wastes (especially from waste Chapters 4 to 7) are comparable to certain production residues used within those industries. • Quantities vary but, in certain cases, permits can include restrictions to the amount used related to the combustion fuel (e.g. coal) in weight. 	

13.3 Annex III - Example tool for converting emission levels to different averaging periods

In December 2014, the Netherlands, with the support of Eurelectric, provided in a memo a statistical tool based on Student's T distribution for deriving daily and monthly averages from the 95th percentile of the hourly averages and the yearly averages, based on the plant-specific data collected in 2011–2012 (ADC data set) and on the additional data collection, as well as on further data collected through Eurelectric (EDC data set). The statistical tool was further developed by the Netherlands in August 2015. [326, van Aart and Burgers 2015]

This tool was not used by the TWG for the LCP BREF review. It is presented here as an example tool for converting different types of averaging periods corresponding to emissions from LCPs.

Using 95th percentile of hourly and yearly average levels to derive a monthly average level

The tool provides formulas for estimating the maximum of the daily averages (MaxDA-St) and the maximum of the monthly averages (MaxMA-St) over the year, using as input data: 1) the reported 95th percentile of hourly averages (95 %HA) and yearly averages (YA), and 2) parameters reflecting a typical number of independent hourly averages per day (Nivd), a number of acceptable daily average exceedances in five years (i.e. one exceedance) and a number of minimum valid daily averages per month (i.e. five).

For each plant/pollutant, the memo reports the calculated statistical 95th percentile of the daily averages. By minimising the sum of squares of the difference between the observed and statistically calculated 95th percentiles of the daily averages, an optimal Nivd for the selected plants/pollutants has been determined. An overall Nivd of 2.5 seems to be the best fit for NO_x, SO₂ and dust. A Nivd value of 2.5 corresponds to periods with elevated emissions covering 40 % of the operation time in a day.

Using a Nivd of 2.5, the statistical equations for the calculation of the MaxDA-st and MaxMA-St averages for NO_x, SO₂ and dust are:

- $MaxDA-St = YA + 1.98 * (95\%HA - YA) / \sqrt{Nivd} = YA + 1.25 * (95\%HA - YA)$
- $MaxMA-St = YA + 0.89 * (95\%HA - YA) / \sqrt{Nivd} = YA + 0.56 * (95\%HA - YA)$

For CO, the optimal Nivd of 2.5 shows a poor fit, probably due to the daily and monthly averages of the CO emissions not following the Gaussian distribution. Although this would suggest using a different statistical approach, a Nivd of 1 provides an acceptable fit between the measured and statistical averages. Therefore for CO it is proposed to us a Nivd of 1, which results in the following equations:

- $MaxDA-St = YA + 1.98 * (95\%HA - YA) / \sqrt{Nivd} = YA + 1.98 * (95\%HA - YA)$
- $MaxMA-St = YA + 0.89 * (95\%HA - YA) / \sqrt{Nivd} = YA + 0.89 * (95\%HA - YA)$

Using daily and yearly average levels to derive a monthly average level

Independently of the chosen Nivd, a simplification of the system of equations can be solved as follows to derive a maximum monthly average level interpolated based on the maximum daily average level and on the yearly average:

$$MaxMA-St = 0.45 * MaxDA-St + 0.55 * YA$$

Table 13.1 shows maximum monthly average emission levels that, based on the previous formula, would correspond to the yearly average and maximum daily average levels in some example cases.

Table 13.2: Example of monthly average levels calculated using the NL/Eurelectric tool

NO_x emission levels corresponding to theoretical cases	Maximum daily level, mg/Nm³	Interpolated maximum monthly level, mg/Nm³	Yearly level, mg/Nm³
New > 300 MW _{th} coal-fired PC boiler	100	83.5	70
Existing > 300 MW _{th} coal-fired PC boiler	125	116.75	110
New gas-fired OCGT	35	29.5	25
Existing gas-fired OCGT	40	34.5	30
<i>Source: Example calculations based on [326, van Aart and Burgers 2015]</i>			

13.4 Annex IV - Measurement uncertainties reported by the plants that participated in the 2012 data collection

In the 2012 data collection (see Section 1.3.9), plant operators were asked to provide information on the 'uncertainty of a single measurement for the 95 % confidence interval' for each of the reported pollutants.

This annex gives the uncertainties reported for measurements of NO_x, SO_x and dust, expressed as a percentage of the measured value. When plants reported the uncertainty as an absolute value, the percentage was calculated based on the yearly average emissions.

As for NO_x measurement uncertainty, 191 plants reported uncertainties of 20 % or below, while 101 additional plants reported that the uncertainty was within 20 % without specifying a precise value. Figure 13.1 shows the distribution of NO_x measurement uncertainties, taking into consideration only the plants that reported a specific uncertainty value within 20 %.

To illustrate the correlation between percentage uncertainty and emission level, the left-hand side of the figure plots the percentage measurement uncertainty versus the yearly average NO_x emission concentration of the same plant. While most observations are located in the lower left triangle of the quadrant, the correlation between the uncertainty and the emission level is too weak to be expressed in a statistically significant mathematical form. The right-hand side of the same figure plots, in increasing order, the percentage uncertainty (solid dots) and the absolute uncertainty (open dots, in log scale) reported by the plants of the sample. Where a plant reported the measurement uncertainty as a percentage but not as a concentration, the absolute uncertainty was approximated by multiplying the percentage uncertainty by the average yearly emission level. Note that the dots (percentage and absolute uncertainty) associated with the same horizontal point do not necessarily correspond to the same plant. The figure shows that around 40 % of these plants reported uncertainties within 5 %, around 75 % of the plants reported uncertainties within 10 %, and more than 90 % reported uncertainties below 15 %. In terms of absolute uncertainties, around 25 % of these plants report uncertainties within 3 mg/Nm³, 50 % of the plants report uncertainties within 6 mg/Nm³, and 75 % of the plants report uncertainties within 12 mg/Nm³.

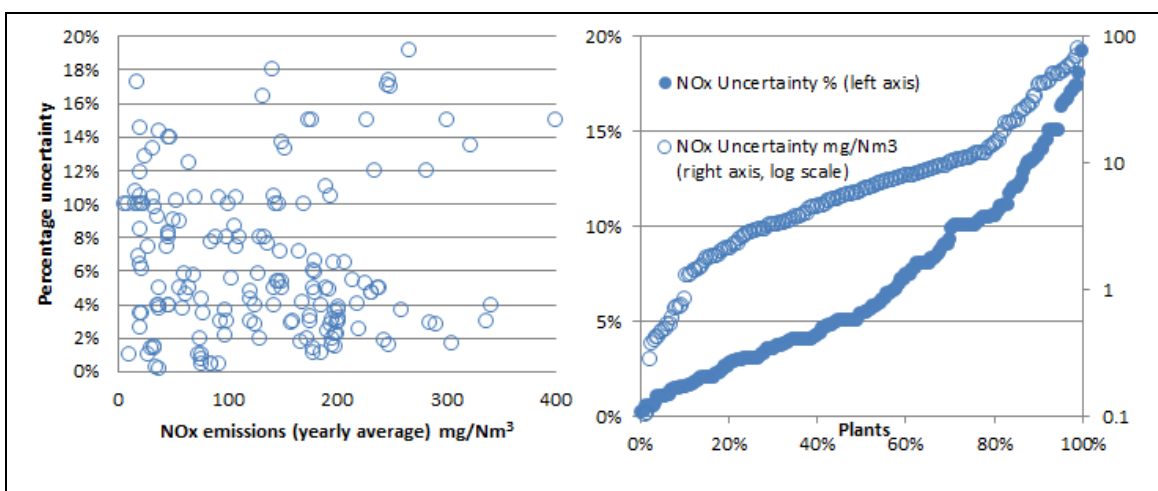

Figure 13.1: Measurement uncertainties reported for NO_x emissions

As for SO₂ measurement uncertainty, 110 plants reported uncertainties of 20 % or below, while 78 additional plants reported that the uncertainty was within 20 % without specifying a precise value. Figure 13.2 shows the distribution of SO₂ measurement uncertainties, taking into consideration only the plants that reported a specific uncertainty value within 20 %.

The left-hand side of the figure plots the percentage measurement uncertainty versus the yearly average SO₂ emission concentration of the same plant, which shows that the correlation between the uncertainty and the emission level is very weak. The right-hand side of the same figure plots, in increasing order, the percentage uncertainty (solid dots) and the absolute uncertainty (open dots, in log scale) reported by the plants of the sample. Where a plant reported the measurement uncertainty as a percentage but not as a concentration, the absolute uncertainty was approximated by multiplying the percentage uncertainty by the average yearly emission level. Note that the dots (percentage and absolute uncertainty) associated with the same horizontal point do not necessarily correspond to the same plant. The figure shows that 40 % of these plants reported uncertainties within 5 %, 75 % of the plants reported uncertainties within 10 %, and 90 % of the plants reported uncertainties below 15 %. In terms of absolute uncertainties, more than 25 % of these plants report uncertainties within 3 mg/Nm³, 50 % of the plants report uncertainties within 6.5 mg/Nm³, and 75 % of the plants report uncertainties within 18 mg/Nm³.

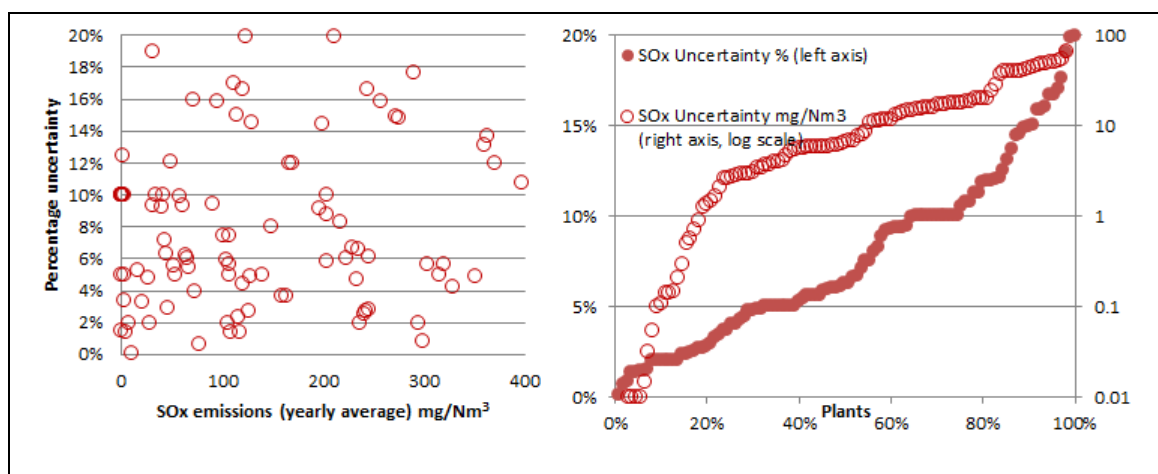

Figure 13.2: Measurement uncertainties reported for SO₂ emissions

As for dust measurement uncertainty, 86 plants reported uncertainties of 30 % or below, while 58 additional plants reported that the uncertainty was within 30 % without specifying a precise value. Figure 13.3 shows the distribution of dust measurement uncertainties, taking into consideration only the plants that reported a specific uncertainty value within 30 %.

The left-hand side of the figure plots the percentage measurement uncertainty versus the yearly average dust emission concentration of the same plant, which shows that the correlation between the uncertainty and the emission level is very weak. The right-hand side of the same figure plots, in increasing order, the percentage uncertainty (solid dots) and the absolute uncertainty (open dots, in log scale) reported by the plants of the sample. Where a plant reported the measurement uncertainty as a percentage but not as a concentration, the absolute uncertainty was approximated by multiplying the percentage uncertainty by the average yearly emission level. Note that the dots (percentage and absolute uncertainty) associated with the same horizontal point do not necessarily correspond to the same plant. The figure shows that around 20 % of these plants reported uncertainties within 5 %, around 50 % of the plants reported uncertainties within 10 %, and around 85 % of the plants reported uncertainties within 20 %. In terms of absolute uncertainties, 25 % of these plants report uncertainties within 0.1 mg/Nm³, one third of the plants are within 0.3 mg/Nm³, 50 % of the plants are within 0.7 mg/Nm³, two thirds of the plants are within 1 mg/Nm³, and 75 % of them report uncertainties within 1.3 mg/Nm³.

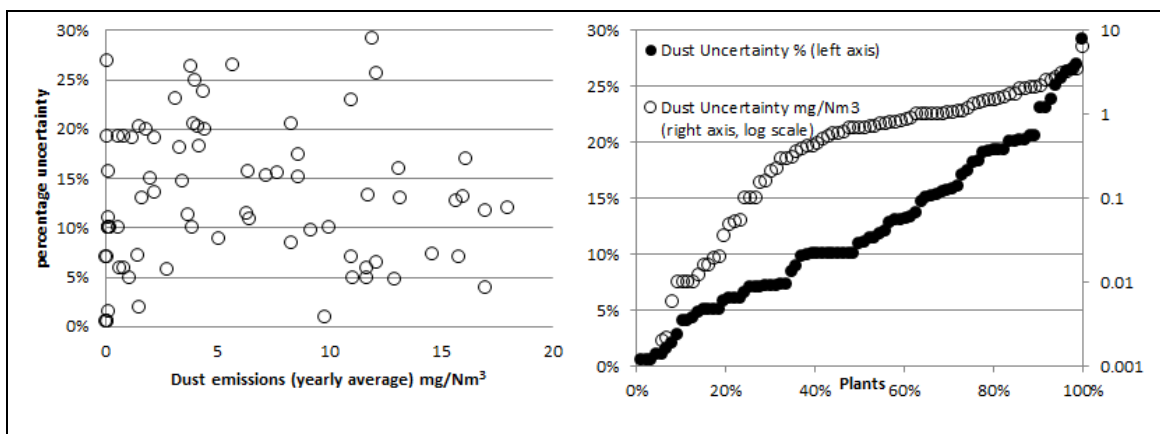

Figure 13.3: Measurement uncertainties reported for dust emissions

GLOSSARY

This glossary is meant to facilitate the understanding of the information contained in this document. The definitions of terms in this glossary are not legal definitions (even if some of them may coincide with definitions given in European legislation), they are meant to help the reader understand some key terms in the context of their use in the specific sector covered by this document.

This glossary is divided into the following sections:

- I. ISO country codes
- II. Monetary units
- III. Unit prefixes, number separators and notations
- IV. Units and measures
- V. Chemical elements
- VI. Acronyms and definitions

I. ISO country codes

ISO code	Country
<i>Member States (*)</i>	
AT	Austria
BE	Belgium
BG	Bulgaria
CZ	Czech Republic
CY	Cyprus
DE	Germany
DK	Denmark
EE	Estonia
EL	Greece
ES	Spain
FI	Finland
FR	France
HU	Hungary
IE	Ireland
IT	Italy
LT	Lithuania
LU	Luxembourg
LV	Latvia
MT	Malta
NL	Netherlands
PL	Poland
PT	Portugal
RO	Romania
SE	Sweden
SI	Slovenia
SK	Slovakia
UK	United Kingdom
<i>Non-member countries</i>	
CN	China
JP	Japan
NO	Norway
US	United States
(*) The protocol order of the Member States is based on the alphabetical order of their geographical names in the original language(s).	

II. Monetary units

Code ⁽¹⁾	Country/territory	Currency
<i>Member State currencies</i>		
EUR	Euro area ⁽²⁾	euro (pl. euros)
DKK	Denmark	Danish krone (pl. kroner)
GBP	United Kingdom	pound sterling (inv.)
SEK	Sweden	krona (pl. kronor)
<i>Other currencies</i>		
NOK	Norway	Norwegian krone
USD	United States	US dollar
⁽¹⁾ ISO 4217 codes. ⁽²⁾ Includes Austria, Belgium, Cyprus, Estonia, Finland, France, Germany, Greece, Ireland, Italy, Luxembourg, Malta, the Netherlands, Portugal, Slovakia, Slovenia and Spain.		

III. Unit prefixes, number separators and notations

Numbers in this document are written using the '.' character as the decimal separator and the space as the separator for thousands.

The symbol ~ (around; more or less) is the notation used to indicate approximation.

The symbol Δ (delta) is the notation used to indicate a difference.

The following table contains the frequently used prefixes:

Symbol	Prefix	10 ⁿ	Word	Decimal Number
Y	yotta	10 ²⁴	Septillion	1 000 000 000 000 000 000 000 000
Z	zetta	10 ²¹	Sextillion	1 000 000 000 000 000 000 000
E	exa	10 ¹⁸	Quintillion	1 000 000 000 000 000 000
P	peta	10 ¹⁵	Quadrillion	1 000 000 000 000 000
T	tera	10 ¹²	Trillion	1 000 000 000 000
G	giga	10 ⁹	Billion	1 000 000 000
M	mega	10 ⁶	Million	1 000 000
k	kilo	10 ³	Thousand	1000
h	hecto	10 ²	Hundred	100
da	deca	10 ¹	Ten	10
-----	-----	1	One	1
d	deci	10 ⁻¹	Tenth	0.1
c	centi	10 ⁻²	Hundredth	0.01
m	milli	10 ⁻³	Thousandth	0.001
μ	micro	10 ⁻⁶	Millionth	0.000 001
n	nano	10 ⁻⁹	Billionth	0.000 000 001
p	pico	10 ⁻¹²	Trillionth	0.000 000 000 001
f	femto	10 ⁻¹⁵	Quadrillionth	0.000 000 000 000 001
a	atto	10 ⁻¹⁸	Quintillionth	0.000 000 000 000 000 001
z	zepto	10 ⁻²¹	Sextillionth	0.000 000 000 000 000 000 001
y	yocto	10 ⁻²⁴	Septillionth	0.000 000 000 000 000 000 000 001

IV. Units and measures

Unit symbol	Unit name	Measure name (Measure symbol)	Conversion and comment
A	ampere	Electric current (<i>I</i>)	
AC kWh	kilowatt-hours	Electric energy from alternating current	
atm	normal atmosphere	Pressure (P)	1 atm = 101 325 N/m ²
bar	bar	Pressure (P)	1.013 bar = 100 kPa = 1 atm
barg	bar of gauge pressure.	Pressure relative to current atmospheric pressure	
°C	degree Celsius	Temperature (T) temperature difference (ΔT)	
DC kWh	kilowatt-hours	Electrical energy from direct current	
g	gram	Weight	
h	hour	Time	
ha	hectare	Area	1 ha = 10 ⁴ m ²
Hz	hertz	Frequency (f)	
J	joule	Energy	
K	kelvin	Temperature (T) temperature difference (ΔT)	0 °C = 273.15 K
kcal	kilocalorie	Energy	1 kcal = 4.1868 kJ
kg	kilogram	Weight	
kJ	kilojoule	Energy	
kPa	kilopascal	Pressure	
kWh	kilowatt-hour	Energy	1 kWh = 3 600 kJ
l	litre	Volume	
m	metre	Length	
m ²	square metre	Area	
m ³	cubic metre	Volume	
mg	milligram	Weight	1 mg = 10 ⁻³ g
mm	millimetre		1 mm = 10 ⁻³ m
min	minute		
MW _e	megawatts electric (energy)	Electric energy	
MW _{th}	megawatts thermal (energy)	Thermal energy Heat	
nm	nanometre		1 nm = 10 ⁻⁹ m
Nm ³	normal cubic metre	Volume	at 101.325 kPa, 273.15 K
ouE	European odour unit	Odour	
Pa	pascal		1 Pa = 1 N/m ²
ppb	parts per billion	Composition of mixtures	1 ppb = 10 ⁻⁹
ppm	parts per million	Composition of mixtures	1 ppm = 10 ⁻⁶
ppmw	parts per million by weight	Composition of mixtures	
ppmv	parts per million by volume	Composition of mixtures	
rpm RPM	revolutions per minute	Rotational speed, frequency	
s	second	Time	
sq ft	square foot	Area	1 sq ft = 0.092 m ²
St	stokes	Kinematic viscosity	1 St = 10 ⁻⁴ m ² /s; old, cgs unit
t	metric tonne	Weight	1 t = 1000 kg or 10 ⁶ g
t/d	tonnes per day	Mass flow Materials consumption	

Glossary

t/yr	tonnes per year	Mass flow Materials consumption	
V	volt	Voltage (V) Electric potential	
vol-% % v/v	percentage by volume	Composition of mixtures	
wt-% % w/w	percentage by weight	Composition of mixtures	
W	watt	Power	1 W = 1 J/s
yr	year	Time	
μm	micrometre	Length	1 μm = 10 ⁻⁶ m

V. Chemical elements

Symbol	Name	Symbol	Name
Ac	Actinium	Mn	Manganese
Ag	Silver	Mo	Molybdenum
Al	Aluminium	N	Nitrogen
Am	Americium	Na	Sodium
Ar	Argon	Nb	Niobium
As	Arsenic	Nd	Neodymium
At	Astatine	Ne	Neon
Au	Gold	Ni	Nickel
B	Boron	No	Nobelium
Ba	Barium	Np	Neptunium
Be	Beryllium	O	Oxygen
Bi	Bismuth	Os	Osmium
Bk	Berkelium	P	Phosphorus
Br	Bromine	Pa	Protactinium
C	Carbon	Pb	Lead
Ca	Calcium	Pd	Palladium
Cd	Cadmium	Pm	Promethium
Ce	Cerium	Po	Polonium
Cf	Californium	Pr	Praseodymium
Cl	Chlorine	Pt	Platinum
Cm	Curium	Pu	Plutonium
Co	Cobalt	Ra	Radium
Cr	Chromium	Rb	Rubidium
Cs	Caesium	Re	Rhenium
Cu	Copper	Rf	Rutherfordium
Dy	Dysprosium	Rh	Rhodium
Er	Erbium	Rn	Radon
Es	Einsteinium	Ru	Ruthenium
Eu	Europium	S	Sulphur
F	Fluorine	Sb	Antimony
Fe	Iron	Sc	Scandium
Fm	Fermium	Se	Selenium
Fr	Francium	Si	Silicon
Ga	Gallium	Sm	Samarium
Gd	Gadolinium	Sn	Tin
Ge	Germanium	Sr	Strontium
H	Hydrogen	Ta	Tantalum
He	Helium	Tb	Terbium
Hf	Hafnium	Tc	Technetium
Hg	Mercury	Te	Tellurium
Ho	Holmium	Th	Thorium
I	Iodine	Ti	Titanium
In	Indium	Tl	Thallium
Ir	Iridium	Tm	Thulium
K	Potassium	U	Uranium
Kr	Krypton	V	Vanadium
La	Lanthanum	W	Tungsten
Li	Lithium	Xe	Xenon
Lr	Lawrencium	Y	Yttrium
Lu	Lutetium	Yb	Ytterbium
Md	Mendelevium	Zn	Zinc
Mg	Magnesium	Zr	Zirconium

VI. Acronyms and definitions

Term used	Definition
Boiler	Any combustion plant with the exception of engines and gas turbines, process furnaces or heaters
Combined-cycle gas turbine (CCGT)	A CCGT is a combustion plant where two thermodynamic cycles are used (i.e. Brayton and Rankine cycles). In a CCGT, heat from the flue-gas of a gas turbine (operating according to the Brayton cycle to produce electricity) is converted to useful energy in a heat recovery steam generator (HRSG), where it is used to generate steam, which then expands in a steam turbine (operating according to the Rankine cycle to produce additional electricity). For the purpose of these BAT conclusions, a CCGT includes configurations both with and without supplementary firing of the HRSG.
Combustion plant	Any technical apparatus in which fuels are oxidised in order to use the heat thus generated. For the purposes of these BAT conclusions, a combination formed of: <ul style="list-style-type: none"> • two or more separate combustion plants where the flue-gases are discharged through a common stack, or • separate combustion plants which have been granted a permit for the first time on or after 1 July 1987, or for which the operators have submitted a complete application for a permit on or after that date, which are installed in such a way that, taking technical and economic factors into account, their flue-gases could, in the judgment of the competent authority, be discharged through a common stack <p>is considered as a single combustion plant.</p> <p>For calculating the total rated thermal input of such a combination, the capacities of all individual combustion plants concerned, which have a rated thermal input of at least 15 MW, shall be added together.</p>
Combustion unit	Individual combustion plant
Continuous measurement	Measurement using an automated measuring system permanently installed on site
Direct discharge	Discharge (to a receiving water body) at the point where the emission leaves the installation without further downstream treatment
Existing plant	A combustion plant which is not a new plant
Existing unit	A combustion unit which is not a new unit
Existing flue-gas desulphurisation (FGD) system	A flue-gas desulphurisation (FGD) system which is not a new FGD system
Flue-gas desulphurisation (FGD) system	System composed of one or a combination of abatement technique(s) whose purpose is to reduce the level of SO _x emitted by a combustion plant
Gas oil	Any petroleum-derived liquid fuel falling within CN code 2710 19 25, 2710 19 29, 2710 19 47, 2710 19 48, 2710 20 17 or 2710 20 19. Or any petroleum-derived liquid fuel of which less than 65 vol-% (including losses) distils at 250 °C and of which at least 85 vol-% (including losses) distils at 350 °C by the ASTM D86 method.
Heat to power ratio	Ratio of generated heat over electrical power in a cogeneration system.
Heavy fuel oil (HFO)	Any petroleum-derived liquid fuel falling within CN code 2710 19 51 to 2710 19 68, 2710 20 31, 2710 20 35, 2710 20 39. Or any petroleum-derived liquid fuel, other than gas oil, which, by reason of its distillation limits, falls within the category of heavy oils intended for use as fuel and of which less than 65 vol-% (including losses) distils at 250 °C by the ASTM D86 method. If the distillation cannot be determined by the ASTM D86 method, the petroleum product is also categorised as a heavy fuel oil.
Net electrical efficiency (combustion unit and IGCC)	Ratio between the net electrical output (electricity produced on the high-voltage side of the main transformer minus the imported energy – e.g. for auxiliary systems' consumption) and the fuel/feedstock energy input (as the

	fuel/feedstock lower heating value) at the combustion unit boundary over a given period of time
Net mechanical energy efficiency	Ratio between the mechanical power at load coupling and the thermal power supplied by the fuel
Net total fuel utilisation (combustion unit and IGCC)	Ratio between the net produced energy (electricity, hot water, steam, mechanical energy produced minus the imported electrical and/or thermal energy (e.g. for auxiliary systems' consumption)) and the fuel energy input (as the fuel lower heating value) at the combustion unit boundary over a given period of time
Net total fuel utilisation (gasification unit)	Ratio between the net produced energy (electricity, hot water, steam, mechanical energy produced, and syngas (as the syngas lower heating value) minus the imported electrical and/or thermal energy (e.g. for auxiliary systems' consumption)) and the fuel/feedstock energy input (as the fuel/feedstock lower heating value) at the gasification unit boundary over a given period of time
New plant	A combustion plant first permitted at the installation following the publication of these BAT conclusions or a complete replacement of a combustion plant on the existing foundations following the publication of these BAT conclusions
New unit	A combustion unit first permitted at the combustion plant following the publication of these BAT conclusions or a complete replacement of a combustion unit on the existing foundations of the combustion plant following the publication of these BAT conclusions
New flue-gas desulphurisation (FGD) system	Either a flue-gas desulphurisation (FGD) system in a new plant or a FGD system which includes at least one abatement technique introduced or completely replaced in an existing plant following the publication of these BAT conclusions
Operated hours	The time, expressed in hours, during which a combustion plant, in whole or in part, is operated and is discharging emissions to air, excluding start-up and shutdown periods
Periodic measurement	Determination of a measurand (a particular quantity subject to measurement) at specified time intervals using manual or automated methods
Post-combustion plant	System designed to purify the flue-gases by combustion which is not operated as an independent combustion plant, such as a thermal oxidiser equipment (i.e. tail gas incinerator), used for the removal of the pollutant(s) (e.g. VOC) content from the flue-gas with or without the recovery of the heat generated therein. Staged combustion techniques, where each combustion stage is confined within a separate chamber, which may have distinct combustion process characteristics (e.g. fuel to air ratio, temperature profile), are considered integrated in the combustion process and are not considered post-combustion plants. Similarly, when gases generated in a process heater/furnace or in another combustion process are subsequently oxidised in a distinct combustion plant to recover their energetic value (with or without the use of auxiliary fuel) to produce electricity, steam, hot water/oil or mechanical energy, the latter plant is not considered a post-combustion plant
Predictive emissions monitoring system (PEMS)	System used to determine the emissions concentration of a pollutant from an emission source on a continuous basis, based on its relationship with a number of characteristic continuously monitored process parameters (e.g. the fuel gas consumption, the air to fuel ratio) and fuel or feed quality data (e.g. the sulphur content)
Process fuels from the chemical industry	Gaseous and/or liquid by-products generated by the (petro-)chemical industry and used as non-commercial fuels in combustion plants
Process furnaces or heaters	<p>Process furnaces or heaters are:</p> <ul style="list-style-type: none"> • combustion plants whose flue-gases are used for the thermal treatment of objects or feed material through a direct contact heating mechanism (e.g. cement and lime kiln, glass furnace, asphalt kiln, drying process, reactor used in the (petro-)chemical industry), or • combustion plants whose radiant and/or conductive heat is transferred to objects or feed material through a solid wall without using an intermediary heat transfer fluid (e.g. coke battery furnace, cowper, furnace or reactor heating a process stream used in the (petro-)chemical industry such as a steam cracker furnace, process heater used for the regasification of liquefied natural gas (LNG) in LNG terminals). <p>As a consequence of the application of good energy recovery practices, process</p>

	heaters/furnaces may have an associated steam/electricity generation system. This is considered to be an integral design feature of the process heater/furnace that cannot be considered in isolation
Refinery fuels	Solid, liquid or gaseous combustible material from the distillation and conversion steps of the refining of crude oil. Examples are refinery fuel gas (RFG), syngas, refinery oils, and pet coke
Residues	Substances or objects generated by the activities covered by the scope of this document, as waste or by-products
Start-up and shut-down period	The time period of plant operation as determined pursuant to the provisions of Commission Implementing Decision 2012/249/EU of 7 May 2012, concerning the determination of start-up and shut-down periods for the purposes of Directive 2010/75/EU of the European Parliament and the Council on industrial emissions
Valid (hourly average)	An hourly average is considered valid when there is no maintenance or malfunction of the automated measuring system
As	The sum of arsenic and its compounds, expressed as As
CH ₄	Methane
C ₃	Hydrocarbons having a carbon number equal to three
C ₄₊	Hydrocarbons having a carbon number of four or greater
CO	Carbon monoxide
COD	Chemical oxygen demand. Amount of oxygen needed for the total oxidation of the organic matter to carbon dioxide
COS	Carbonyl sulphide
Cd	The sum of cadmium and its compounds, expressed as Cd
Cd+Tl	The sum of cadmium, thallium and their compounds, expressed as Cd+Tl
Cr	The sum of chromium and its compounds, expressed as Cr
Cu	The sum of copper and its compounds, expressed as Cu
daf	Dry, ash-free
Dust	Total particulate matter (in air)
Fluoride	Dissolved fluoride, expressed as F ⁻
HCN	Hydrogen cyanide
HCl	All inorganic gaseous chlorine compounds, expressed as HCl
HF	All inorganic gaseous fluorine compounds, expressed as HF
Hg	The sum of mercury and its compounds, expressed as Hg
H ₂ S	Hydrogen sulphide
NH ₃	Ammonia
N ₂ O	Dinitrogen monoxide (nitrous oxide)
NO _x	The sum of nitrogen monoxide (NO) and nitrogen dioxide (NO ₂), expressed as NO ₂
Ni	The sum of nickel and its compounds, expressed as Ni
Pb	The sum of lead and its compounds, expressed as Pb
PCDD/F	Polychlorinated dibenzo-dioxins and -furans
RCG	Raw concentration in the flue-gas. Concentration of SO ₂ in the raw flue-gas as a yearly average (under the standard conditions given under General considerations) at the inlet of the SO _x abatement system, expressed at a reference oxygen content of 6 vol-% O ₂
Sulphide, easily released	The sum of dissolved sulphide and of those undissolved sulphides that are easily released upon acidification, expressed as S ²⁻
SO _x	The sum of sulphur dioxide (SO ₂) and sulphur trioxide (SO ₃), expressed as SO ₂
SO ₂	Sulphur dioxide
SO ₃	Sulphur trioxide
Sulphite	Dissolved sulphite, expressed as SO ₃ ²⁻
Sulphate	Dissolved sulphate, expressed as SO ₄ ²⁻
Sb+As+Pb+Cr+Co+Cu+Mn+Ni+V	The sum of antimony, arsenic, lead, chromium, cobalt, copper, manganese, nickel, vanadium and their compounds, expressed as Sb+As+Pb+Cr+Co+Cu+Mn+Ni+V
TOC	Total organic carbon, expressed as C (in water)
TSS	Total suspended solids. Mass concentration of all suspended solids (in water), measured via filtration through glass fibre filters and gravimetry.
TVOC	Total volatile organic carbon, expressed as C (in air)
Zn	The sum of zinc and its compounds, expressed as Zn

ACRONYMS

ACI: Activated carbon injection
AGR: Acid gas removal
ASU: Air separation unit
BAT-AEL: Emission level associated with the Best Available Techniques, as defined in the IED
BBS: Biased burner firing
BF: Bag filter
BFB: Bubbling fluidised bed
BF(G): Blast furnace (gas)
BFBC: Bubbling FBC
BOF(G): Basic oxygen furnace (gas)
BOOS: Burner out of service
CCGT: Combined-cycle gas turbine
CCRs: Coal combustion residues
CCPs: Coal combustion products
CCS: Carbon capture and storage
CHP: Combined heat and power
COD: Chemical oxygen demand
COG: Coke oven gas
CFB: Circulating fluidised bed
CFBC: Circulating FBC
DBB: Dry-bottom boiler
DENOX: process/technique for reducing nitrogen oxides from flue-gases
DESOX: process/technique for reducing sulphur oxides from flue-gases
DF: Dual fuel (engine type)
DLE: Dry low-NO_x emissions
DLN: Dry low-NO_x burners
DOE: see US DOE
DSI: Duct sorbent injection
EOR: Enhanced oil recovery (techniques for increasing the amount of crude oil that can be extracted from an oil field)
E-PRTR: European Pollutant Release and Transfer Register
ESP: Electrostatic precipitator
ETS: (European) Emissions Trading System
FBC: Fluidised bed combustion
FGD: Flue-gas desulphurisation
FGR: Flue-gas recirculation
GD: Gas diesel (engine type)
GF: Grate firing
GT: Gas turbine
HHV: Higher heating value
HFO: Heavy fuel oil
HP: High pressure (steam)
HRSG: Heat recovery steam generator
IED: Industrial Emissions Directive (2010/75/EU)
IGCC: Integrated gasification combined cycle
IP: Intermediate pressure (steam)
IPPC: Integrated Pollution Prevention and Control
I&S: Iron and Steel
ISO: International Organisation for Standardisation
I-TEQ: International Toxicity Equivalence (used for PCDD/F)
LCP: Large combustion plant
LHV: Lower heating value
LNB: Low-NO_x burners
LNG: Liquefied natural gas
LP: Low pressure (steam)
MS: (European) Member State

MSW: Municipal solid waste
MDEA: Methyl diethanolamine
ND: Not determined
NG: Natural gas
NMVOC: Non-methane volatile organic compounds
NOC: Normal operating conditions
NO_x: Nitrogen oxides (NO + NO₂, normally expressed as NO₂)
OFA: Overfire air
OCGT: Open-cycle gas turbine
OTNOC: Other than normal operating conditions
PAH: Polycyclic aromatic hydrocarbon
PC: Pulverised combustion
PCDD/F: Polychlorinated dibenzodioxins/furans
PEMS: Predictive emissions monitoring system
PFBC: Pressurised FBC
PM: Particulate matter
PM₁₀: Particulate matter of less than 10 µm
PM_{2.5}: Particulate matter of less than 2.5 µm
PRB: Powder River Basin (*US coal*)
QA/QC: Quality Assurance/Quality Control
RDF: Refuse-derived fuel
SACR: Selective autocatalytic NO_x reduction
SC: Supercritical (steam)
SCR: Selective catalytic reduction
SDA: Spray dry absorber
SG: Spark-ignited (engine type)
SNCR: Selective non-catalytic reduction
SNG: Synthetic natural gas
SO_x: Sulphur oxides (SO₂ and SO₃)
SRF: Solid refuse-derived fuel
ST: Steam turbine
TOC: Total organic carbon
TSS: Total suspended solids (water)
TWG: Technical Working Group
UHC: Unburnt hydrocarbons
USC: Ultra-supercritical (steam)
US DOE: United States Department of Energy
US EPA: United States Environmental Protection Agency
VOC: Volatile organic compound
WBB: Wet-bottom boiler
WFGD: Wet FGD
WWT(P): Waste water treatment (plant)

REFERENCES

- [1] Eurelectric, *Draft text proposal for Chapter 2*, 2012.
- [2] EEB, *Mercury emissions from coal-fired combustion plants*, 2012.
- [3] LCP TWG, *Data collection*, 2012.
- [4] De Biasi, 'Combined cycle heat rates at simple cycle \$/kW plant costs', , Vol. March - April 2013, 2013.
- [5] Eurelectric, *Draft text proposal & study 'Reference Power Plant North-Rhine-Westfalia VGB PowerTech 2004'*, 2012.
- [6] Marcogaz, *Draft text proposal*, 2012.
- [7] NOVOX - Finland, *CHP and district heating networks in cold climate*, 2012.
- [8] NOVOX - Finland, *Industrial CHP production*, 2012.
- [9] UK-TWG, *CHP-Ready and BAT for UK CCGT power stations*, 2012.
- [10] METSO, *DNA LCP Emission Monitoring*, 2012.
- [11] Airikka et al., 'Optimized combustion through collaboration of boiler and automation supplier', 2010, Amsterdam, The Netherlands.
- [12] UK-TWG, *Mid merit operation for existing plants*, 2012.
- [13] METSO, *Start-up analysis*, 2012.
- [14] MOBLEY et al., 'Organic acids can enhance wet limestone flue-gas scrubbing', Vol. May 1986, pp. 32 - 35.
- [15] WANG and BURBANK, *Adipic Acid enhanced lime and limestone testing at the EPA alkali scrubbing test facility*, 1982.
- [16] GEA Niro, *Draft text proposal*, 2012.
- [18] CaO Hellas - GREECE, *Greenlime injection method for mitigation of sulfur compounds at power plants using lignite or other solid fossil fuels*, 2011.
- [19] EEB, *NOx reduction in small or reduced load plants: Mobotec's NOx/SO2 reduction technology*, 2012.
- [20] COOMBS et al., 'SCR levels of NOx Reduction with ROFA and Rotamix (SNCR) at Dynegy's Vermilion Power Station', 2004, Clearwater Beach, FL, USA.
- [21] Poland, *ROFA (R) Combustion system*, 2012.
- [22] US-EPA, *Technology characterization: reciprocating engines*, 2008.
- [23] Finland, UNECE Gothenburg Protocol: *Draft Guidance document on control techniques for emissions from stationary sources*, 2012.
- [24] Evonik and Southern Company, *SCR Catalyst regeneration - 10 years of R&D and commercial application*, 2008.
- [25] Haldor Topsoe, *Description of SCR DENOX process*, 2012.
- [26] Jacobsen, 'NOx reduction system for diesel engines today & tomorrow', *Worldwide Independent Power*, Vol. May 2011, pp. 19 - 24.
- [27] ICAC, *White Paper - SCR control of NOx emissions from fossil-fuel-fired electric power plants*, 2009.
- [28] S.Wang et al., 'Mercury emissions and speciation of coal-fired power plants in China', Vol. 9, 2009, pp. 24051-24083.

- [29] Pritchard et al., 'Advanced SCR catalysts tune oxidized mercury removal', *Power*, Vol. Vol. 154, NO.8, 2010.
- [30] VDI, *Draft VDI 3927 Part 1:2013 Waste gas cleaning*, 2013.
- [31] CHIRONNA, 'Wet scrubbing of acidic gases', , Vol. June 2011, 2011.
- [32] Airikka, *Combustion Optimizer (Case Billerud AB Karlsborg Sweden)*, 2012.
- [36] EGTEI, *Emerging techniques and technologies for large combustion plants up to 500 MWth capacity*, 2012.
- [37] EGTEI, *Fact sheets on emerging techniques for plants > 500 MWth*, 2012.
- [38] US-GAO, *Mercury Control Technologies at Coal-Fired Power Plants Have Achieved Substantial Emissions Reductions*, 2009.
- [39] Dombrowski et al., 'Balance of Plant Effects of Bromide Addition for Mercury Control', 2012, Baltimore, USA.
- [40] EEB, *A comparison between Texas and EU Lignite*, 2012.
- [43] EPPSA, *Draft text proposal*, 2012.
- [44] Lecomte and Jankov, *Site visits in Finland*, European Commission, JRC IPTS EIPPCB, 2012.
- [45] JRC, *JRC Reference Reports 2009 – LNG for Europe – Some important issues for consideration*, 2009.
- [46] dos SANTOS et al., 'Comparison of Different Gas Turbine Inlet Air Cooling Methods', Vol. 61, 2012, pp. 40 - 45.
- [47] Donaldson Company, *Cooling inlet air improves turbine output*, 2005.
- [48] Sayyaadi et al., 'Efficiency enhancement of a gas turbine cycle using an optimized tubular recuperative heat exchanger', Vol. 38, 2012, pp. 362 - 375.
- [49] DeCicco et al., 'Multi-Pollutant Emission Reduction Technology for Stationary Gas Turbines and IC Engines', Personal Communication, 2004.
- [50] EUTurbines, *Draft text proposal*, 2012.
- [51] Jensen-Holm et al., 'SCR DeNOx catalyst considerations when using biomass in power generation', Personal Communication, 2010.
- [52] CEFIC, *Study about NOx reduction in large combustion plants in petrochemical plants*, 2012.
- [53] UNEP, *Process Optimization Guidance for Reducing Mercury Emissions from Coal Combustion in Power Plants*, 2010.
- [54] UK-TWG, *UK Wish list* , 2012.
- [55] EEB, *Efficiency levels currently being achieved by new CCGTs*, 2012.
- [56] Srivastava et al., 'Control of Mercury Emissions from Coal-fired Electric Utility Boilers', 2006.
- [57] LCP TWG - Domestic fuels initiative , *Coal in Europe in 2012 - Lignite production, coal production and imports*, 2014.
- [58] Nejla Ballisoy and Dr Hans-Wilhelm Schiffer, *Lignite in Europe*, 2001.
- [59] DEBRIV, *Lignite in Germany 2011 - Facts and figures*, 2011.
- [60] Lecomte, *Site visits report to the Netherlands and Germany*, 2014.
- [61] Commission, *BREF for Large Combustion Plants*, 2006.
- [62] UK-TWG, *UK TWG 19 Downshot Boilers*, 2012.

- [63] BDEW, *Emission performance of selected waste co-incinerating CFBC plants (main fuel hard coal or lignite)*, 2013.
- [64] ECOBA, *Production and Utilisation of CCPs in 2010 in Europe (EU 15)*, 2010.
- [65] Caldas-Vieira and Feuerborn, *Impact of Political Decisions on Production and Use of Coal Combustion Products in Europe*, 2013.
- [66] TWG Task Force on Energy Efficiency, *Report of the Task-Force Energy Efficiency, Large Combustion Plants BREF, TWG Activities coordinated by EPPSA and EURELECTRIC*, 2014.
- [67] Nalbandian, *Trace element emissions from coal*, 2012.
- [68] EEB, *Emission data from Plant 520*, 2013.
- [69] EEB, *Mercury yearly average BATAel proposals in D1 of the LCP BREF EEB proposed amendments*, 2013.
- [70] EEB, *Data gaps in the TWG survey questionnaires. Mercury data obtained using public access to information*, 2013.
- [71] Luminant, *Annual continuous emissions monitoring systems (CEMS) certification testing report for the Oak Grove Steam Electric Station Unit 1 mercury monitor*, 2013.
- [72] EEB, *continuous mercury control at PPL Montana Corette with concrete-friendly C-PAC (TM)*, 2013.
- [73] KEMA - VGB Powertech, *Final Report: Bromide Addition to reduce mercury emissions*, 2012.
- [74] ECOBA, *Ecoba Comments on EEB Paper*, 2012.
- [75] VGB Powertech, *VGB Comments on EEB Paper*, 2012.
- [76] EEB, *Description of fuel pre-treatment technique. Draft text proposal*, 2012.
- [77] EEB, *Characteristics of coal burned at Holcomb Station*, 2012.
- [78] Bustard et al., 'Full-Scale Evaluation of Mercury Control Technologies with PRB Coals', *ICAC's Clean Air Technologies & Strategies Conference & Workshop 2005*, ADA-ES, 2005, Baltimore, MD - March 7 – 10, 2005.
- [79] Hutson et al., 'Assessment of PCDD/F and PBDD/F emissions from coal-fired power plants during injection of brominated activated carbon for mercury control', *Atmospheric Environment*, Vol. 43, No 26, 2009, pp. 3973-3980.
- [80] EEB, *Examples plants for the commercial operation of brominated activated carbon injection*, 2013.
- [81] Vosteen, 'A Survey on Bromine Based Mercury Abatement from Flue Gases at Coal Combustion and Waste Incineration Plants', 2010.
- [82] Berry et al., 'Bromine Injection Technology for removing vapor phase mercury', , 2011, Nuremberg, Germany, 9-13 May 2011.
- [83] EUROGYPSUM, VGB Powertec, ECOBA, *FGD Gypsum, Quality criteria and analysis methods*, 2012.
- [84] VDI, *Draft of revision of VDI guideline 3927-2*, 2013.
- [85] Eurelectric, *Draft text proposal for Chapter 5*, 2012.
- [86] Eurelectric, *Eurelectric comments to LCP BREF D1*, 2013.
- [87] Germany, *Germany comments to LCP BREF D1*, 2013.
- [88] Denmark, *Denmark comments to LCP BREF D1*, 2013.
- [89] EPPSA, *EPPSA comments to LCP BREF D1*, 2013.

References

- [90] Finland, Background documents Finland D1, 2013.
- [91] AET, *Danish EPA detailed comment on BAT AEELs for biomass table 10 10 and DK comment 11*, 2015.
- [92] Freimark et al., 'NOX Reduction in Large Gas Turbines by Firing an Oil/Water Emulsion', *VGB Kraftwerkstechnik*, Vol. 70, 1990, pp. 742-748.
- [93] Eurelectric, EURELECTRIC wishlist, 2011.
- [94] Eurelectric, *Draft text proposal for Chapter 6*, 2012.
- [95] UNECE, *Guidance document on control techniques for emissions of sulphur, NOx, VOCs, dust (including PM10, PM2.5 and black carbon) from stationary sources*, 2012.
- [96] Malta, *Malta comments to LCP D1*, 2013.
- [97] Jacobsen, 'NOx reduction system for diesel engines today & tomorrow', , Vol. May 2011, pp. 19-24.
- [98] EUROMOT, *EUROMOT comments to LCP D1*, 2013.
- [99] FRANCE, *France comments to LCP D1*, 2013.
- [100] FRANCE, FR presentation in LCP Intermediate Meeting in Seville, June 2014.
- [101] Eurelectric, Eurelectric presentation in the LCP Intermediate Meeting in Seville, June 2014.
- [102] ETN, 01 - 2013_02_ETN position paper on liquid-fuel-fired turbines, 2013.
- [103] NY Env , SCR in gas oil GT (SHOREHAM NY), 2010.
- [104] Eurostat, Population: United Nations Demographic Yearbook; EU-28: Eurostat (online data code; demo_pjan), Land area: United Nations Demographic Yearbook, 2011.
- [105] Eurostat, *Eurostat Energy, transport and environment indicators 2014*, 2014.
- [106] IEA, *Key World Energy Statistics 2014*, 2014.
- [107] Eurostat, Eurostat online data code: nrg_105a, 2016.
- [108] Eurostat, Eurostat online data code: nrg_113a, 2016.
- [109] Poland, *Eurostat data submitted by Poland as comments to LCP D1*, 2013.
- [110] COM, *EU ENERGY, TRANSPORT AND GHG EMISSIONS TRENDS TO 2050. Reference scenario 2013*, 2013.
- [111] Marcogaz, *Marcogaz comments to LCP D1*, 2013.
- [112] E-PRTR, E-PRTR 2013, 2013.
- [113] EEA, European Environment Agency, 2013.
- [114] Khan et al., 'Boiler and Its Tangential Fuel Firing System', *International Journal of Automation and Control Engineering (IJACE)*, Vol. Volume 3 Issue 3, August 2014, 2014.
- [115] NOVOX, *NOx emission study – theory and experiences of selected fluidized bed boilers*, 2013.
- [116] EUTurbines, *EU Turbines comments to LCP BREF D1*, 2013.
- [117] Eurostat, Eurostat online data code: nrg_110a , 2013.
- [118] Hussy et al., *International comparison of fossil power efficiency and CO2 intensity – Update 2014 - Ecofys*, 2014.
- [119] Italy, *Italy comments to LCP BREF D1*, 2013.
- [120] EEB, *EEB comments to LCP BREF D1*, 2013.

- [121] Eurelectric, *Draft text proposal Chapter 3*, 2012.
- [122] ETN, *ETN comments to LCP BREF D1*, 2013.
- [123] Eurelectric, EURELECTRIC proposal for LCP BREF 2006, 2001.
- [124] HMIP, *Combustion Processes: Large Boilers and Furnaces 50 MW(th) and over - Chief Inspector's Guidance Note. Processes subject to integrated pollution control*, 1995.
- [125] OSPAR, *Large Combustion Installations (>50 MWth). Emissions and reduction in emissions of heavy metals and persistent organic compounds*, OSPAR Convention for the Protection of the Marine Environment of the North-East Atlantic, 1997.
- [126] Davidson, *How coal properties influence emissions*, IEA Coal Research, 2000.
- [127] Corinair, *CORINAIR Atmospheric Emission Inventory Guidebook - EMEP Expert panels/ UNECE*, 1996.
- [128] Heide, 'Advanced SNCR Technology for Power Plants', *Power-Gen International*, 2011, Las Vegas, December 13 – 15, 2011.
- [129] Sloss et al., *Organic Compounds from Coal Utilisation.*, 1993.
- [130] Finland, *Finnish expert report on Best Available Techniques in Large Combustion Plants*, 2000.
- [131] EPA, *EPA Office of Compliance Sector Notebook Project. Profile of the Fossil Fuel Electric Power Generation Industry*, 1997.
- [132] Rentz et al., *Technical background document for the actualisation and assessment of UN/ECE protocols related to the abatement of the transboundary transport of nitrogen oxides from stationary sources*, 1999.
- [133] Wienstrom, *Simmering Power Station, Light and Heat for Vienna*, 2001.
- [134] Bell et al., *Combustion*, 2000.
- [135] Wärtsilä, *Engine Driven Plant EU BREF Document*, 2000.
- [136] EUROMOT, *EU BAT Document on reciprocating engine driven power plant-technologies offering high environmental standard*, 2001.
- [137] Siemens, *The proven Model V84.2 and V94.2 gas turbines - Power Generation Group (KWU)*, 2001.
- [138] NWS, *Kraftwerk Altbach, Das Heizkraftwerk*, 2001.
- [139] Cortés et al., *Principles and Concepts of Combustion Gasification and Thermodynamic Cycles*, 2000.
- [140] Siemens, *Benson boilers for maximum cost-effectiveness in power plants - Power Generation Group (KWU)*, 2000.
- [141] Helsinki Energy, *Vuosaari Power Plant A and B. Environmentally benign energy generation*, 2001.
- [142] Siemens, *Using refinery residues and coal in IGCC plants provides clean and efficient power - Power Generation Group (KWU)*, 1999.
- [143] Electrabel, *Combined Heat and Power. A way towards rational use of energy*, 1996.
- [144] Eurovent, *Contribution to the LCP BREF 2006: cooling systems*, 1998.
- [145] UBA AT, *Stand der Technik für Großfeuerungsanlagen in Österreich im Hinblick auf die IPPC-RL*, 2000.
- [146] Hourfar, *Efficiency and capacity potentials in existing power plants*, VGB PowerTech, 2001.

References

- [147] VDI, *VDI 3986, Ermittlung des Wirkungsgrades von konventionellen Kraftwerken (Entwurf). Determination of efficiencies of conventional power stations (draft version)*, 1998.
- [148] CIEMAT, *Flue Gas Cleaning - Clean Coal Technologies Handbook - PROGRAMA I+D OCICARBON*, 2000.
- [149] Clarke et al., *Trace elements - emissions from coal combustion and gasification*, 1992.
- [150] Maier et al., *Schwermetalle in kohlebefeuerten Kraftwerken - VGB Kraftwerkstechnik*, 1992.
- [151] Rentz et al., *Ermittlung der Schwermetallemissionen aus stationären Anlagen in Baden-Württemberg und im Elsaß, hier: Feuerungsanlagen, Projekt Europäisches Forschungszentrum für Maßnahmen zur Luftreinhaltung (PEF), PEF 4 94 001*, 1996.
- [152] Martel, C., *Analyse der Schwermetallströme in Steinkohlefeuerungen unter besonderer Berücksichtigung des Betriebszustandes der Anlage, Forschungsbericht*, 1998.
- [153] ESAA, *Emission Estimation Technique Manual for Fossil Fuel Power Generation*, Electricity Supply Association of Australia Ltd, 1999.
- [154] CBT, *CHP and Power Plants. Straw for energy production*, 1998.
- [155] Sanders, 'Emissions, corrosion and alkali chemistry in straw-fired combined heat and power plants', *1st world conference on biomass for energy and industry*, 2000, Seville - Spain.
- [156] Kokk et al., *World's largest biofuel fired CFB boiler for Alholmens Kraft*, 2000.
- [157] Molero de Blas, *Pollutant formation and interaction in the combustion of heavy liquid fuels*, 1995.
- [158] UFIP, *Meilleures Techniques Disponibles - Combustibles Liquides et Installations de Combustion de Petites et Moyennes Puissances*, Union Francaise des Industries Petrolieres, 2001.
- [159] Marcogaz, *Draft text proposal for chapter 7*, 2012.
- [160] EUROMOT, *The EUROMOT Briefing 2000*, 2000.
- [161] Cañadas, L. et al., 'Heat-rate and NO_x optimisation in coal boilers using an advanced in-furnace monitoring system - Combined Power plant Air Pollutant Control Symposium', 2001.
- [162] Rodríguez, F. et al., *OPTICOM: Advanced Automatic Monitoring System of Local Combustion Conditions for Improving Boiler Performance in PC Power plants - UK Meeting on Coal Research and its Applications*, 2002.
- [163] ECSC, *Application of Advanced Modelling Techniques for Coal Utilisation Processes. Furnace Monitoring System to Improve Combustion and Boiler Efficiency (OPTICOM) at Unit 3 of Compostilla Power Station - ECSC, Contract 7220-ED/096 Final Report*, 2001.
- [164] Rigby et al., 'SCR: The most effective technology for NO_x reduction in large combustion plants' *NOXCONF: International Conference on Industrial Atmospheric Pollution*, 2001.
- [165] EUROMOT, *Background paper on measured emission levels of liquid fuel -fired engines*, 2002.
- [166] Ceramics GmbH, 'SCR Experiences on Marine Diesel Engines - A clean fast ferry - Ship Propulsion Conference', 2002.
- [167] Austrian Ministry of Environment, *Examples of techniques to be considered in the determination of BAT*, 2000.
- [168] CEN, *EN ISO 14001:2015 Environmental management systems – Requirements with guidance for use*, 2015.

- [169] TWG 2006 LCP BREF , *TWG contribution to the second draft of LCP BREF 2006*, 2003.
- [170] DEBCO, *DEBCO – Demonstration of Large Scale Biomass Co-Firing and Supply Chain Integration, D7.10 Advanced Biomass Co-Firing Guidebook, 2013*, 2013.
- [171] COM, 'Regulation (EC) No 1221/2009 of the European Parliament and of the Council of 25 November 2009 on the voluntary participation by organisations in a Community eco-management and audit scheme (EMAS), repealing Regulation (EC) No 761/2001 and Commission Decisions 2001/681/EC and 2006/193/EC', *Official Journal of the European Union*, Vol. L 342, 22.12.2009, 2009, pp. 1-45.
- [172] DG Environment, *What is Emas?*, 2010.
- [173] Theodore and Buonicore, *Air Pollution Control Equipment*, 1992.
- [174] Soud, *Particulate control handbook for coal fired plants*, 1993.
- [175] Soud, *Developments in particulate control for coal combustion - IEA Coal Research*, 1995.
- [176] VDI, *VDI 3678 Part 1: Electrostatic precipitators. Process and waste gas cleaning*, 1998.
- [177] Lurgi, *Cleaning of process and waste gases*, 1999.
- [178] ERM, *Revision of the EC Emission Limit Values for New Large Combustion Installations (> 50 MWth). Final Report*, 1996.
- [179] Robson, *A Review of the Industrial Uses of Continuous Monitoring Systems - UK Environment Agencies*, 1998.
- [180] IAF, *International Accreditation Forum website*, 2010.
- [181] CEFIC, *CEFIC comments to LCP BREF D1*, 2013.
- [182] Mitsubishi, 'World's Largest-Class High-performance, Economical Flue Gas Desulfurization Facilities for US Coal-Fired Plants', *Mitsubishi Heavy Industries Technical Review*, Vol. Vol. 48 No. 1 (March 2011), 2011, pp. 38 - 40.
- [183] UK-TWG, *UK TWG 7 Future SO2 BAT for existing coal stations with a mid-merit operational category*, 2011.
- [184] UK, *UK comments to LCP BREF D1*, 2013.
- [185] UK, *UK TWG 21 Diesel plants for emergency use or located on islands*, 2013.
- [186] UK, *UK TWG 10 NOx and CO for existing baseload CCGTS >300MWth*, 2013.
- [187] Bischoff, *The Wet ammonia process*, 2001.
- [188] Alstom, *NID state-of-the-art dry FGD technology*, 2002.
- [189] Sound, *Developments in FGD*, IEA Coal Research Centre, 2000.
- [190] EPPSA, *Information on dry desulphurisation systems*, 2015.
- [191] EPPSA, *HCl and HF emissions reduction with dry desulphurisation systems*, 2015.
- [192] Notter et al., 'Rauchgasreinigung bei Biomassekraftwerken', *Umwelt Magazin*, 2002.
- [193] Wilhelm et al., *OPERATING EXPERIENCE AND LATEST DEVELOPMENTS OF ALSTOM POWER'S 300 MWe CLASS CFB BOILERS*, 2011.
- [194] Verbund, *Umweltbericht 96 - Kapitel 7 - NOx-Reduktion*, 1996.
- [195] OSIRIS, *Technical document intended for the revision of the BREFs - Accessible ELVs on a pre-heated combustion air natural gas boiler Boiler: gas – 60 MW*, 2012.
- [196] Fortum, *RI-Jet low NOx burners*, 2002.
- [197] ADEME, *Emerging techniques - lean premix burners for gas-fired boilers*, 2015.

References

- [198] OSEC, *Cost Analysis of NO_x Control Alternatives for Stationary Gas Turbines Contract No. DE-FC02-97CHIO877*, 1999.
- [199] IFC, Environmental, Health, and Safety (EHS) Guidelines, 2007.
- [200] AT, *Power plant Leopoldau*, 2000.
- [201] Alstom, *Alstom LNB reports*, 2012.
- [202] Calepa, *Guidance for Power Plant Siting and Best Available Control Technology - USA State of California*, 1999.
- [203] Reimer and Jensen-Holn, 'Limitations in reduced load SCR operation', *VGB Powertech*, Vol. 1, No 2, 2013, pp. 80-86.
- [204] CZ, *CZ-01_SNCR Reference large boilers 2013*, 2014.
- [205] Schüttenhelm et al., 'CZ-02_VGB.PowerTech.12_2013.SNCR Rybn.ERC', *VGB Powertech*, Vol. 13, 2013.
- [206] Yara, *Draft text proposal Section 3.1.4.2.2*, 2012.
- [207] FuelTech, *02_NOxOut SNCR 2008*, 2008.
- [208] Von der Heide, *Advanced SNCR Technology for Power Plants*, 2011.
- [209] Haldor Topsoe, *SNOX™ Efficient and cost-effective removal of SO_x, NO_x and particulates from flue gas when burning high sulphur fuels*, 2014.
- [210] USA EPA, *Technical Development Document for the Proposed Effluent Limitations Guidelines and Standards for the Steam Electric Power Generating Point Source Category - EPA-821-R-13-002*, 2013.
- [211] Wylie et al., 'Duke Energy Carolina LLC's Strategy and Initial Experience of FGD Waste Water Treatment Systems', *International Water Conference*, 2008, San Antonio, Texas.
- [212] Ramos, A. F., et al., 'Biological nitrogen and phenol removal from saline industrial wastewater by submerged fixed-film reactor', *Journal of hazardous materials*, Vol. 142.1, 2007, pp. 175-183.
- [213] COGEN, *A Guide to Cogeneration*, 1999.
- [214] EEB, *Impact on plant efficiency of component refurbishments and upgrades*, 2013.
- [215] CZ, *Czech Republic comments to LCP BREF D1*, 2013.
- [216] E&P, *Euroheat&Power comments to LCP BREF D1*, 2013.
- [217] Poulsen, 'Advantages of Ultra Super Critical Technology in Power Generation', *International Conference on Clean Coal Technologies for our Future*, 2005, Sardinia, Italy.
- [218] Bendixen, *Experiences with Coal fired USC Boilers in Denmark - BURMEISTER & WAIN ENERGY A/S*, 2003.
- [219] IEA, *Energy Technology Perspectives, Scenarios & Technologies to 2050*, 2008.
- [220] IEA, *World Energy Outlook*, 2010.
- [221] Kaplan, *Power Plants: Characteristics and Costs*, 2008.
- [222] World Bank, *CLEAN COAL POWER GENERATION TECHNOLOGY REVIEW: WORLDWIDE EXPERIENCE AND IMPLICATIONS FOR INDIA*, 2008.
- [223] Cortina, *Flue.gas condenser for biomass boilers*, 2006.
- [224] EPRI, *Revised Wet Stack Design Guide*, 2012.
- [225] Carrea et al., 'Development from MAC® to SUPERMAC® technology', *Magaldi News*, Vol. 1, No 17, 2014, pp. 16-21.

- [226] Zajadatz et al., *Development and implementation of the AEV Burner for the ALSTOM GT13E2*, 2012.
- [227] E-PRTR, E-PRTR 2014, 2014.
- [228] Kakaras and Grammelis, *Size and type of existing electricity-generating capacity using solid fuels within an enlarged EU*, CSTA and VGB for the EC - DG energy and transport, 2000, p. 97.
- [229] MPS, 'Advanced technology for Nordjyllandsværket Unit 3', 1998.
- [230] Benesh, 'Planning New Coal-fired Power Plants', *VGB Power Tech*, 2001, p. 8.
- [231] Rentz et al., *Exemplary Investigation into the State of Practical Realisation of Integrated Environmental Protection within the Ceramics Industry under Observance of the IPPC-Directive and the Development of BAT Reference Documents*, Karlsruhe French-German Institute for Environmental Research, 2001, p. 213.
- [236] Greenpeace, *Smoke and Mirrors*, 2015.
- [240] Korobitsyn, *NEW AND ADVANCED ENERGY CONVERSION TECHNOLOGIES. ANALYSIS OF COGENERATION, COMBINED AND INTEGRATED CYCLES*, 1998.
- [241] Eurelectric, *Draft proposal for Chapter 7*, 2012.
- [242] Freimark et al., 'Thermodynamically based definition of limits for nitrogen oxides emissions of gas turbine plants', *VGB Powertech*, Vol. 88, 2008, pp. 37-42.
- [243] EUROMOT, *Draft text proposal submitted by EUROMOT as comment to the pre-final draft of the LCP BREF*, 2016.
- [244] COEN, Ultra low-NOx burners, 2012.
- [250] Finkeldei, 'Personal communication', Personal Communication, 2000.
- [251] Krishnan, 'Low NOx Emissions Achieved in Southern California', *Diesel & Gas Turbine Worldwide*, 2002.
- [252] Kristensen, *Formaldehyde reduction by catalyst*, Danish Gas Technology Centre, 2007.
- [253] KEMA, *Hydrocarbon emissions from gas engines*, 2011.
- [254] Convention on Long-Range transboundary Air Pollution, *Document for the determination of costs for activities of Annex V*, 2011.
- [255] Eurofer, *I&S chapter EUROFER draft proposal 15042013*, 2013.
- [256] Eurofer, *I&S draft text proposal EUROFER*, 2014.
- [257] Marathon OIL, 'Personal communication', Personal Communication, 2000.
- [259] Carstensen and Skorping, 'Experience With DLE Turbines at Offshore Installations', *ASME Turbo Expo 2000: Power for Land, Sea, and Air*, 2000, Munich, Germany, May 8–11, 2000.
- [260] Denmark, *Emission data from gas turbines*, 2015.
- [262] Norway, *Norwegian proposal for the offshore part of the BREF*, 2015.
- [263] VEAG, *Die neuen Kraftwerke der VEAG - Kraft für die Zukunft*, 2000.
- [264] Itkonen, A. and Jantunen, M. J., 'The Properties of Fly Ash and Fly Ash Mutagenicity', *Encyclopedia of Environmental Control Technology*, 1989.
- [265] Powergen, *Ratcliffe-on-Soar Power Station. An overview of Flue gas desulphurisation*, 2001.
- [266] UNECE, *Control of Mercury Emissions From Coal-fired Electric Utility Boilers. Note prepared by the secretariat based on information provided by the US delegation*, 2002.

- [267] Sandscheper, 'Experience gained during the manufacture and installation of a corrosion-protected heat pipe heat displacement system around the FGD unit in the Maritsa East power station', *VGB Power Tech*, 2001.
- [268] Joisten et al., *Gas Turbine SCR using SINOx SCR Catalysts Meeting Power Generation and Environmental Needs*, 2000.
- [269] GE, *GE gas turbine. Particulate emissions*, 2002.
- [270] ABB, *Combined Cycle Offshore, Profitable with Compact Waste Heat Recovery Units*, 2000.
- [272] Wang et al., 'A Combustion Test Facility for Testing Low NO_x Combustion Systems', *ASME Turbo Expo 2002: Power for Land, Sea, and Air*, 2002, Amsterdam, The Netherlands, June 3–6, 2002.
- [273] Sahai et al., 'Reduction of NO_x and CO to Below 2ppm in a Diffusion Flame', *ASME Turbo Expo 2003, collocated with the 2003 International Joint Power Generation Conference*, 2003, Atlanta, Georgia, USA, June 16–19, 2003.
- [274] Cheng et al., 'The Chronological Development of the Cheng Cycle Steam Injected Gas Turbine During the Past 25 Years', *ASME Turbo Expo 2002: Power for Land, Sea, and Air*, 2002, Amsterdam, The Netherlands, June 3–6, 2002.
- [275] Cheng, 'The New LM2500 Cheng cycle for power generation and co-generation', *Energy Conversion Management*, Vol. 38, 1997, pp. 15-17.
- [276] Matthee, 'Personal communication', Personal Communication, 2014.
- [277] Wärtsilä, *Engine driven power plants*, 2001.
- [278] US EPA, *Mercury study, report to congress, Volume VIII An Evaluation of Mercury Control Technologies and Costs*, US EPA, 1997.
- [279] COM, *Best Available Techniques (BAT) Reference Document for Iron and Steel Production (IS BREF)*, European Commission, JRC IPTS EIPPCB, 2013.
- [280] EPPSA, *Proposed Draft chapter on CO₂ capture*, 2012.
- [281] Elsen et al., 'Planung und Bau der Pilot-Trocknungsanlage Niederaußem', *VGB Powertech*, Vol. 6, 2001, pp. 69-72.
- [282] EPPSA, *Draft text proposal on lignite drying*, 2012.
- [283] Sweden, *Sweden comments to LCP BREF D1*, 2013.
- [284] CEPI, *CEPI comments to LCP BREF D1*, 2013.
- [285] Couch, *Underground coal gasification*, IEA Clean Coal Centre, 2009.
- [286] EUROMOT, *EUROMOT Position on Methane Slip*, 2012.
- [287] EUROMOT, *EUROMOT Position on two-stage turbo-charging for large internal combustion engines*, 2012.
- [288] EUTurbines, *Comparison of Diffusion Burner and Premix Burner*, Siemens Power Generation, 2013.
- [289] COM, *Best Available Techniques (BAT) Reference Document for Common Waste water and Waste Gas Treatment/Management Systems in the Chemical Sector*, 2016.
- [290] Higa et al., 'State –of-the-art USC coal fired power plant, Isogo repowering project', 2012.
- [291] Peters, *ReACT Reduces Emissions and Water Use*, 2010.
- [292] Gilbert et al., *ReACT Process Evaluation at the North Valmy Station*, 2008.

- [293] Brandin et al., 'Unit operations for production of clean hydrogen-rich synthesis gas from gasified biomass', *Biomass and Bioenergy*, Vol. Volume 35, Supplement 1, October 2011, p. S8–S15.
- [294] Ciferno and Marano, *Benchmarking Biomass Gasification Technologies for Fuels, Chemicals and Hydrogen Production, Prepared for U.S. Department of Energy National Energy Technology Laboratory*, 2002.
- [295] E4Tech, *Review of Technologies for Gasification of Biomass and Wastes*, NNFCC, 2009.
- [296] Wilén et al., *Finnish expert report on best available techniques in energy production from solid recovered fuels*, Finnish Environment Institute, 2004.
- [297] Treviño Coca, *Integrated gasification combined cycle technology: IGCC. Its actual application in Spain: ELCOGAS. Puertollano*, 2001.
- [298] NETL, *Gasifipedia, Commercial Power Production based on Gasification*, 2017.
- [299] Pytlar , 'STATUS OF EXISTING BIOMASS GASIFICATION AND PYROLYSIS FACILITIES IN NORTH AMERICA', *18th Annual North American Waste-to-Energy Conference, NAWTEC 18, May 11-13, 2010*, 2010, Orlando, Florida, USA.
- [300] Pyroneer, *PYRONEER. A new Gasolution - Biomass gasification*, 2017.
- [301] UK Environment Agencies, *Horizontal Guidance for Noise. Part 2 – Noise Assessment and Control*, 2004.
- [302] Holt, *EPRI Gasification Technology Status - August 2002*, EPRI, Electric Power Research Institute, 2002.
- [303] Holt, *EPRI Gasification Technology Status - December 2007*, EPRI - Electric Power Research Institute, 2007.
- [304] Reidick et al., *EVT-Bericht 106/91*, 1991.
- [305] IEA , *Clean Coal Centre database*, 2012.
- [306] DTI, 'Guidance notes on the offshore combustion installations (prevention and control of pollution) regulations', 2001.
- [307] Kvaerner Pulping Oy, *Co-combustion of biomass and coal in fluidised bed systems*, 2001.
- [308] Schmidt et al., 'Technischer Großversuch zur Mitverbrennung von Biomasse in einem Braunkohlekraftwerk', *VGB Powertech*, 1999.
- [309] Kindler et al., 'Altholzmitverbrennung in einem Braunkohlekraftwerk, Tagungsband zum', *VGB-Kongress "Kraftwerke 2000"*, 2000.
- [310] Ekmann et al., *Cofiring of coal and waste*, 1996.
- [311] Hein et al., 'Untersuchungen zum Stand der Mitverbrennung von Klärschlamm, Hausmüll und Biomasse in Kohlekraftwerken', *IVD 2000*, 2000, Stuttgart.
- [312] Palonen et al., 'The Foster Wheeler gasification technology for Biofuels: refuse-derived fuel (RDF) power generation', *Power-Gen Europe*, 2006, Cologne.
- [313] Nieminen et al., 'Biomass and waste gasification and gas co-firing in pulverised coal-fired boilers', *6th European Gasification Conference*, 2004, Institution of Chemical Engineers, Brighton, UK .
- [314] Kurkela, *Review of Finnish Biomass Gasification Technologies. OPET Report 4, Espoo, May 2002*, 2002.
- [315] Salo, 'Carbona Gasification Technologies. Biomass Gasification Plant in Skive ', *Gasification 2010*, 2010, Swedish Gas Centr2 (SGC), Gothenburg, Sweden.
- [316] Raskin et al., 'Power boiler fuel augmentation with a biomass--fired atmospheric circulating fluid-bed gasifier', *Biomass and Bioenergy*, Vol. 20, 2001, pp. 471 - 481.
- [317] EEA, *Air pollution impacts from carbon capture and storage (CCS)*, 2011.

References

- [318] Ourliac et al., 'Projet CANOE – Clean flameless combustion boiler, Rapport final', *Convention ADEME / GDF SUEZ / CORIA*, 2015, / Ecole Centrale Paris #0974C0047.
- [319] Ourliac et al., 'MILD combustion for industrial boilers', *10th European Conference on Industrial Furnaces and Boilers conference (INFUB)*, 2015, Oporto (Portugal).
- [320] Stierlin et al., 'Combustion plants, natural gas and NOX emissions: What is at stake in flameless combustion for NOX Reduction', *EFE Seminar on IED directive and its industrial impacts*, 2011, Paris (France).
- [321] Stierlin, 'Flameless combustion in industrial boilers', *19th EGTEI Meeting*, 2011, Rome (Italy).
- [322] Villiermaux et al., 'GDF SUEZ activities on flameless combustion: from physical phenomena analysis to industrial-scale applications', *International Gas Research Union Conference*, 2008, Paris (France).
- [323] Levy et al., 'Basic thermodynamics of FLOXCOM, the low-NOx gas turbines adiabatic combustor', *Applied Thermal Engineering*, Vol. 24, 2004, pp. 1593 - 1605.
- [324] Milani et al., 'Flameless Oxidation Technology', *25th Event of the Italian Section of the Combustion Institute*, 2002, Rome (Italy).
- [325] Milani et al., *IFRF Online Combustion Handbook: "What is Flameless Combustion?"*, 2002.
- [326] van Aart and Burgers, *Short and long term averages - extended evaluation. Memo for the review of the LCP BREF*, 2015.
- [327] EPPSA, *EPPSA Wishlist*, 2011.
- [328] Blomberg et al., 'Large Scale Biomass Gasification Plant Integrated t a PC Boiler', *Power-Gen Europe 2012*, 2012, Cologne (Germany).
- [329] Skive Fjernvarme, *Environmental report for 2011/2012*, 2012.
- [330] UMWELT + TECHNIK, 'Entschwefelung Dokumentation Braun- und Steinkohlenentschwefelung NRW', 2000.
- [331] Eck and Feuerborn, 'Eurocoalah', *14th International Conference "Coal Ash Utilisation"*, 2007, Miedzzydroje, POLAND.
- [332] Staehle, *Marsulex: UPGRADING YOUR WET FGD SYSTEM*, 2008.
- [333] Nakayama et al., *Commercial Experience and Actual-Plant-Scale Test Facility of MHI Single Tower FGD*, 2005.
- [334] EEB, *NOx emissions from Sandow Power Station, Texas*, 2014.
- [335] ICAC, *SCR control of NOx emissions from fossil-fuel-fired electric power plants - White paper*, 2009.
- [336] dos Santos et al., 'Comparison of Different Gas Turbine Inlet Air Cooling Methods', *WASET International Journal of Aerospace and Mechanical Engineering*, Vol. 6, No 1, 2012, pp. 1-6.
- [337] Szargut, 'Influence of Regenerative Feed Water Heaters on the Operational Costs of Steam Power Plants and HP Plants', *International Journal of Thermodynamics*, Vol. 8 (No.3), 2005, pp. 137-141.
- [338] RAP Online, *Summary of Sino-US Workshop on NOx Emissions Control*, RAP Online, 2013, p. 17.

***Europe Direct is a service to help you find answers
to your questions about the European Union.***

**Freephone number (*):
00 800 6 7 8 9 10 11**

(* The information given is free, as are most calls (though some operators, phone boxes or hotels may charge you).

More information on the European Union is available on the internet (<http://europa.eu>).

HOW TO OBTAIN EU PUBLICATIONS

Free publications:

- one copy:
via EU Bookshop (<http://bookshop.europa.eu>);
- more than one copy or posters/maps:
from the European Union's representations (http://ec.europa.eu/represent_en.htm);
from the delegations in non-EU countries (http://eeas.europa.eu/delegations/index_en.htm);
by contacting the Europe Direct service (http://europa.eu/europedirect/index_en.htm) or
calling 00 800 6 7 8 9 10 11 (freephone number from anywhere in the EU) (*).

(* The information given is free, as are most calls (though some operators, phone boxes or hotels may charge you).

Priced publications:

- via EU Bookshop (<http://bookshop.europa.eu>).

JRC Mission

As the science and knowledge service of the European Commission, the Joint Research Centre's mission is to support EU policies with independent evidence throughout the whole policy cycle.



EU Science Hub
ec.europa.eu/jrc



@EU_ScienceHub



EU Science Hub - Joint Research Centre



Joint Research Centre



EU Science Hub

